

KEYS LLAVES

Unlocking access to the world
C.12



We are a people-focused company, leading the global locksmith industry. Our commitment lies in providing expertise, technology, and innovation to create profitable opportunities in the market of opening solutions.

We strive to grow with you, embrace change, and constantly evolve.

Somos una empresa comprometida con las personas, con liderazgo mundial en el sector de la cerrajería. Te acompañamos aplicando conocimiento, tecnología e innovación para generar negocio en soluciones de apertura.

Estamos abiertos a evolucionar contigo.

Open to your
needs

Abiertos a tus
necesidades

JMA[®]

Opening
the future

JMA UNIVERSE

Universo JMA
JMA unibertsoa
Univers JMA
Das JMA-Universum
Universo JMA
Świat JMA



A8 — A17

FROM TRADITION TO A GLOBAL PROMINENCE

De la tradición a proyección internacional
Tradiziotik nazioarteko proiektzioa
De la tradition à la projection internationale
Von der Tradition zur internationalen Ausrichtung
Da tradição à projeção internacional
Od tradycji po ekspansję międzynarodową

A18 — A25

TOGETHER TO BE THE FIRST

Juntos para ser los primeros
Elkarrekin, lehenak izateko
Ensemble pour être les premiers
Zusammen an der Spitze
Juntos para sermos os primeiros
Razem ku pozycji lidera

A26 — A32

QUALITY MATERIALS FOR LONG-LASTING KEYS

Materiales de calidad para llaves que duran toda la vida
Bizi osoa irauten duten giltzentzako kalitatezko materialak
Matériaux de qualité pour des clés qui durent toute la vie
Qualitätsmaterial für Schlüssel, die das ganze Leben halten
Materiais de qualidade para chaves que duram toda a vida
Wysokiej jakości materiały do produkcji trwałych kluczy

JMA KEYS. CATALOGUE

Llaves JMA. Catálogo
JMA GILTZAK. Katalogoak
Clés JMA. Catalogue
JMA-Schlüssel Katalog
Chaves JMA. Catálogo
Klucze JMA. Katalog



K01 01 — 122

CYLINDER AND SPECIAL KEYS

Llaves de serreta y especiales
Serreta motako giltzak eta bereziak
Clés plates et spéciales
Profilzylinder- und Spezialschlüssel
Chaves de serreta e especiais
Klucze nacinane i specjalne

K02 123 — 143

DIMPLE KEYS

Llaves de puntos
Puntuen giltzak
Clés à points
Bohrmuldenschlüssel
Chaves de pontos
Klucze nawiercane

K03 145 — 147

TUBULAR KEYS

Llaves tubulares
Hodi formako giltzak
Clés tubulaires
Stiftzylinderschlüssel
Chaves tubulares
Klucze rurkowe

K04 149 — 367

VEHICLE KEYS + BLADES / KRC

Llaves de vehículos + Espadines /KRC
Ibilgailuen giltzak + Espadinak / KRC
Clés de voitures + Lames / KRC
Fahrzeugschlüssel + Schlüsselbärte /KRC
Chaves de automóveis + Espadilhas /KRC
Klucze do pojazdów + Groty /KRC

K05 369 — 370

SNAP LOCK KEYS

Llaves de cierre
Ixe Giltzak
Clés de fermeture
Absperrhähne
Chaves de fecho
Klucze Nasadowe

K06 371 — 379

CROSS - SHAPED KEYS

Llaves de cruz
Gurutze motako giltzak
Clés cruciformes
Kreuzbartschlüssel
Chaves de cruz
Klucze krzyżowe

K07 381 — 453

MORTICE KEYS

Llaves de Gorja
Gorja motako giltzak
Clés à gorge
Tresor-Schlüssel
Chaves de gorja
Klucze zasuwowe

K08 455 — 458

WARDROBE KEYS

Llaves artísticas
Giltza artistikoak
Clés artistiques/de style
Artísticas
Chaves artísticas
Klucze ozdobne

K09 459 — 460

LIFT AND MAIL BOX KEYS

Llaves para casillas
Kutxatilarako giltzak
Clés pour casiers
Künstlerische Schlüssel
Chaves para caixas
Klucze do szafek

BRAND GUIDES. AUTOMOTIVE

Guía de marcas. Automoción
Marken gida. Automozioa
Guide des marques. Automobile
Markenindex. Automobilindustrie
Índice de marcas. Automóbel
Spis marek.Samochodowe

461 — 514

CAR-PICK UP BRANDS

Marcas automovil - camioneta
Automobila-kamioneta markak
Marques de voitures - camionnettes
Automarken - Lieferwagen-Marken
Marcas de automóveis - pick-ups
Marki samochodowe - furgonetki

515 — 520

TRUCK BRANDS

Marcas camión
Kamioi markak
Marques de camions
Lkw-Marken
Marcas de camion
Marki pojazdów ciężarowych

521 — 540

MOTORCYCLE BRANDS

Marcas motocicleta
Motozikleta markak
Marques de motos
Motorradmarken
Marcas de motocicletas
Marki motocykli

USER GUIDE FOR THIS CATALOGUE. BRAND INDEX

Guía de uso de este catálogo.
Katalogo hau erabiltzeko jarraibideak.
Guide d'utilisation du catalogue.
Leitfaden für die Nutzung dieses Katalogs.
Guia de Utilização deste catálogo.
Instrukcja korzystania z niniejszego katalogu.

542 — 543

LEGAL WARNING

Aviso Legal
Lege-oharra
Mentions légales
Impressum
Aviso legal
Informacje prawne

544 — 545

MANUAL OF USE

Manual de uso
Erabilera-eskuliburua
Guide d'utilisation
Bedienungsanleitung
Manual de Utilização
Instrukcja obsługi

546 — 549

DESCRIPTION AND TERMINOLOGY

Descripción y terminología
Deskribapen eta terminologia
Description et terminologie
Beschreibung und Terminologie
Descrição e terminologia
Opis i objaśnienie terminów

550 — 551

SYMBOLS AND NATIONALITIES

Símbolos y nacionalidades
Ikur eta nazionalitateak
Symboles et nationalités
Symbole und Nationalitäten
Símbolos e nacionalidades
Symbole i kraje

553 — 579

BENCHMARK INDEX

Índice de referencias
Erreferentzia aurkibidea
Index des références
Referenzverzeichnis
Índice de referências
Spis modeli

582 — 592

BRAND INDEX

Índice de marcas
Marken aurkibidea
Index des marques
Markenverzeichnis
Índice de marcas
Spis marek

Index

De la tradición a la
proyección internacional

From tradition to a global prominence



TRADITION AND VALUES

Since our humble artisanal beginnings in 1942, we have maintained our commitment to a traditional model grounded in the metal industry, enriched with enduring human values.

We possess extensive expertise in key manufacturing, bolstered by our own fusion equipment, which provides the flexibility to meticulously craft our products and deliver unparalleled customer service.

TRADICIÓN Y VALORES

Desde nuestros inicios más artesanales en 1942, nos hemos mantenido fieles a un modelo tradicional basado en una industria del metal con unos fuertes valores humanos.

Somos expertos en la fabricación de llaves, y también disponemos de nuestro propio equipo de fusión, lo que nos da la flexibilidad para garantizar el cuidado meticuloso de nuestros productos y el más alto nivel de servicio al cliente.

Our origins stemmed from the metal industry



COMMITMENT TO QUALITY

One of our group's core strengths lies in our unwavering dedication to ensuring the quality of our products.

This is evident through our partnerships with demanding locksmith manufacturers and our presence in the automotive market. Moreover, our quality management system is certified according to IATF 16949:2016 and ISO 9001:2015 standards.

COMPROMISO CON LA CALIDAD

Uno de los puntos fuertes de nuestro grupo es nuestra dedicación a garantizar la calidad de nuestros productos.

Prueba de ello es que suministramos a los fabricantes de cerrajería más exigentes, así como al mercado de la automoción, y que nuestro sistema de gestión de la calidad cuenta con las certificaciones IATF 16949:2016 e ISO 9001:2015.

Tradition, innovation, and progress

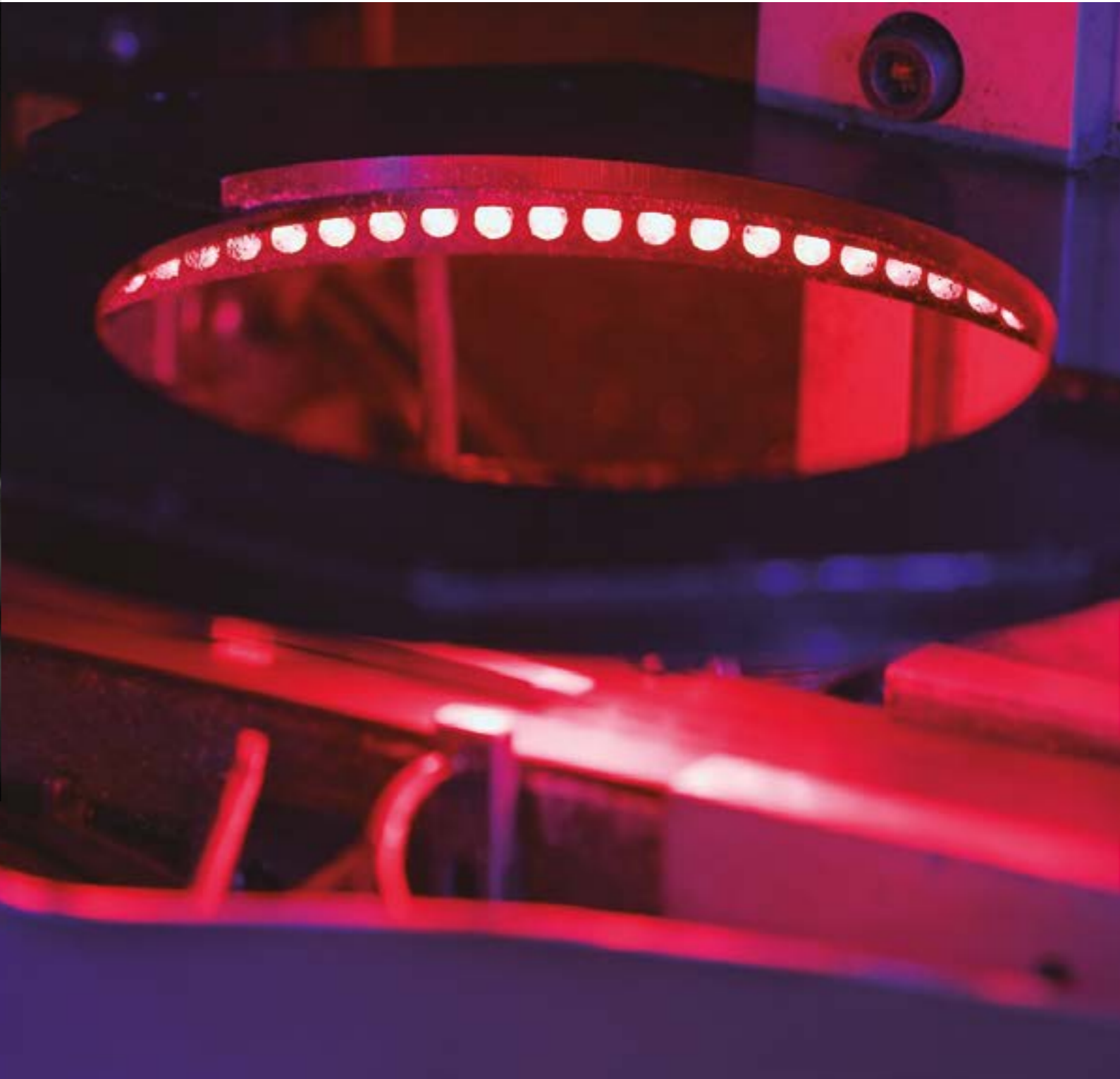

INNOVATIVE TECHNOLOGIES

With our extensive experience, we possess the expertise to develop unique solutions that are precise, sophisticated, and reliable, setting us apart in the industry.

Our investments in automated industrial processes and groundbreaking technologies enable us to deliver exceptional products, efficient services, and user-friendly solutions that meet global market demands.

TECNOLOGÍAS INNOVADORAS

Nuestros años de experiencia nos han dotado de los conocimientos necesarios para crear soluciones precisas, sofisticadas y de garantía que nos hacen únicos en el sector.

Realizamos inversiones en procesos industriales automatizados y tecnologías innovadoras inventivas que proporcionan productos excelentes, servicios eficaces y soluciones intuitivas. Generamos un negocio global que satisface todas las demandas del mercado.

Sophisticated and guaranteed solutions



IMPACTFUL INITIATIVES

Our keys are manufactured using 100% recycled materials. By managing our own supply of brass and nickel silver, we minimize transportation emissions and reduce our carbon footprint. In addition to sourcing local materials, we are at the forefront of developing lead-free products to minimize their environmental impact.

Our environmental management system is [ISO 14001:2015](#) certified, and our occupational health and safety system complies with [ISO 45001:2018](#) standards.

GESTOS QUE MARCAN LA DIFERENCIA

Nuestras llaves se fabrican con materiales 100% reciclados. Gracias a que gestionamos nuestra propia fuente de suministro de latón y alpaca, limitamos las emisiones del transporte, reduciendo nuestra huella de carbono. Además de utilizar materiales Km 0, también estamos a la vanguardia del desarrollo de productos sin plomo con el objetivo de reducir su uso en la producción de llaves y minimizar su impacto medioambiental.

Nuestro sistema de gestión medioambiental cuenta con la certificación [ISO 14001:2015](#), y nuestro sistema de salud y seguridad en el trabajo, con la [ISO 45001:2018](#).

Dedicated to responsible practices



CONFIDENCE EXPERTS

We are renowned experts in the global opening solutions industry, offering a wide range of adaptable products and services that are user-friendly.

Thanks to our extensive presence, we instil confidence and make ourselves available wherever you need us. We enhance your experience by embracing new technical and technological challenges.

We invest in the development and manufacturing of tailored solutions specifically for professionals in the locksmith, hardware, and vast supply chain industries.

ESPECIALISTAS DE CONFIANZA

Somos expertos en soluciones de apertura global gracias a una amplia gama de productos y servicios adaptables y fáciles de usar.

Nuestra presencia global nos permite generar confianza y presentarnos allí donde nos necesites. Diseñamos una mejor experiencia abordando nuevos retos técnicos y tecnológicos.

Invertimos en el desarrollo y fabricación de soluciones personalizadas para ti, profesional del sector de la cerrajería, la ferretería y la gran cadena de suministro.

Your trusted professional, always within reach



EMBRACING NEW POSSIBILITIES

With our inventive and service-oriented approach, we have become a global industry leader.

Our global strategy spans more than ten countries, with sales offices across Europe, America, Asia, and Africa. We have production facilities in both Europe and America, and our products are sold in over 100 countries worldwide.

NUEVAS OPORTUNIDADES

Gracias a nuestra estrategia global, basada en nuestra vocación innovadora y orientada al servicio, somos líderes mundiales del sector.

Estamos presentes en diez países, con oficinas de ventas repartidas por Europa, América, Asia y África, instalaciones de producción tanto en Europa como en América y ventas en más de 100 países de todo el mundo.

Together, we unlock future opportunities



JMA®

HEADQUARTERS

SPAIN

MANUFACTURING

SPAIN. MEXICO.

LOGISTICS & DISTRIBUTION

USA. UK. PORTUGAL. POLAND. MOROCCO. FRANCE. PERU. COLOMBIA.



● DISTRIBUTION CENTERS ● MANUFACTURING PLANTS

OPEN-MINDEDNESS

We promote the development of new concepts that offer adaptable, effective, and complementary solutions for the locksmith industry.

Our commitment to innovation is evident in our wide product range, which includes key-cutting machines, remote controls, automotive solutions, and accessories.

Through enhanced networking capabilities, we design reliable solutions that align with your work style, providing confidence at every step.

ABIERTOS A EVOLUCIONAR

Promovemos el desarrollo de nuevos conceptos que aporten soluciones adaptables, eficaces y complementarias para la industria de las llaves, así como para máquinas duplicadoras, mandos a distancia, automóviles y accesorios.

Nuestro enfoque innovador puede apreciarse en toda la gama de productos, que incluye máquinas duplicadoras, mandos a distancia, automoción y accesorios.

Con capacidades de conexión en red que nos ayudan a acercarnos a su estilo de trabajo, diseñamos soluciones fiables que inspiran confianza.

Sustainable growth via innovative solutions.



EVERY DAY IS THE START OF THE FUTURE

Our success is built on our unwavering commitment to people. We design products that cater to global opening solutions, meeting the ever-evolving demands of the market.

Your requirements are our top priority, and your future is the driving force behind our daily efforts. We are always nearby, ready to assist you in every possible way.

EL FUTURO EMPIEZA TODOS LOS DÍAS

Nuestro compromiso con las personas es la base de nuestro éxito. Diseñamos productos que aportan soluciones globales de apertura para satisfacer las demandas del mercado.

Soluciones que mejoren tu vida respetando el medio ambiente por medio de una planificación cuidadosa, tecnología innovadora y procesos de fabricación sostenibles. Porque tus necesidades son nuestra principal preocupación y tu futuro es la razón por la que empezamos cada día.

Always prioritising the end user





**Quality
materials
for long-
lasting
keys**

THE HIGHEST QUALITY KEYS

In order to create the highest quality keys and provide our customers with unparalleled service, the quality of raw materials is paramount. We meticulously choose the finest materials, tailored to meet the specific requirements and intended usage of our customers.

Our expertise enables us to manufacture versatile and customized keys using different techniques. We source materials like nickel silver, brass, steel, and aluminium from multiple channels to provide tailored solutions for each customer's unique needs. The integration of our foundry within the Altuna group gives us a competitive advantage, allowing us to develop new materials and enhance service quality.

LLAVES DE LA MÁS ALTA CALIDAD

Para producir las mejores llaves y ofrecer a nuestros clientes el mejor servicio, las materias primas son esenciales. Dependiendo de los requisitos de nuestros clientes y del uso previsto, podemos producirlas utilizando diferentes técnicas.

Nuestra capacidad para fabricar llaves utilizando materiales como alpaca, latón, acero y aluminio de diversas fuentes de suministro, nos permite ofrecer soluciones específicas para cada necesidad de nuestros clientes. Disponer de una fundición dentro del grupo Altuna también nos proporciona una ventaja competitiva en el desarrollo de nuevos materiales y en la calidad del servicio.

We meticulously select the raw material



EXUDING SOPHISTICATION AND EXCELLENCE

A hallmark of our key production lies in the meticulous attention to detail, showcased by the impeccable polished finish adorning each and every key in our extensive catalogue.

We take great pride in overseeing every aspect of our work, ensuring the highest standards of quality and sophisticated solutions.

SOFISTICACIÓN Y AUTOEXIGENCIA

Nuestra seña de identidad, que se transmite en la creación de todas las familias de llaves, es un acabado pulido brillo muy cuidado.

Hemos sido reconocidos por supervisar meticulosamente cada aspecto de nuestro trabajo, al tiempo que ofrecemos las soluciones más completas y sofisticadas disponibles.

Polished and lustrous finish

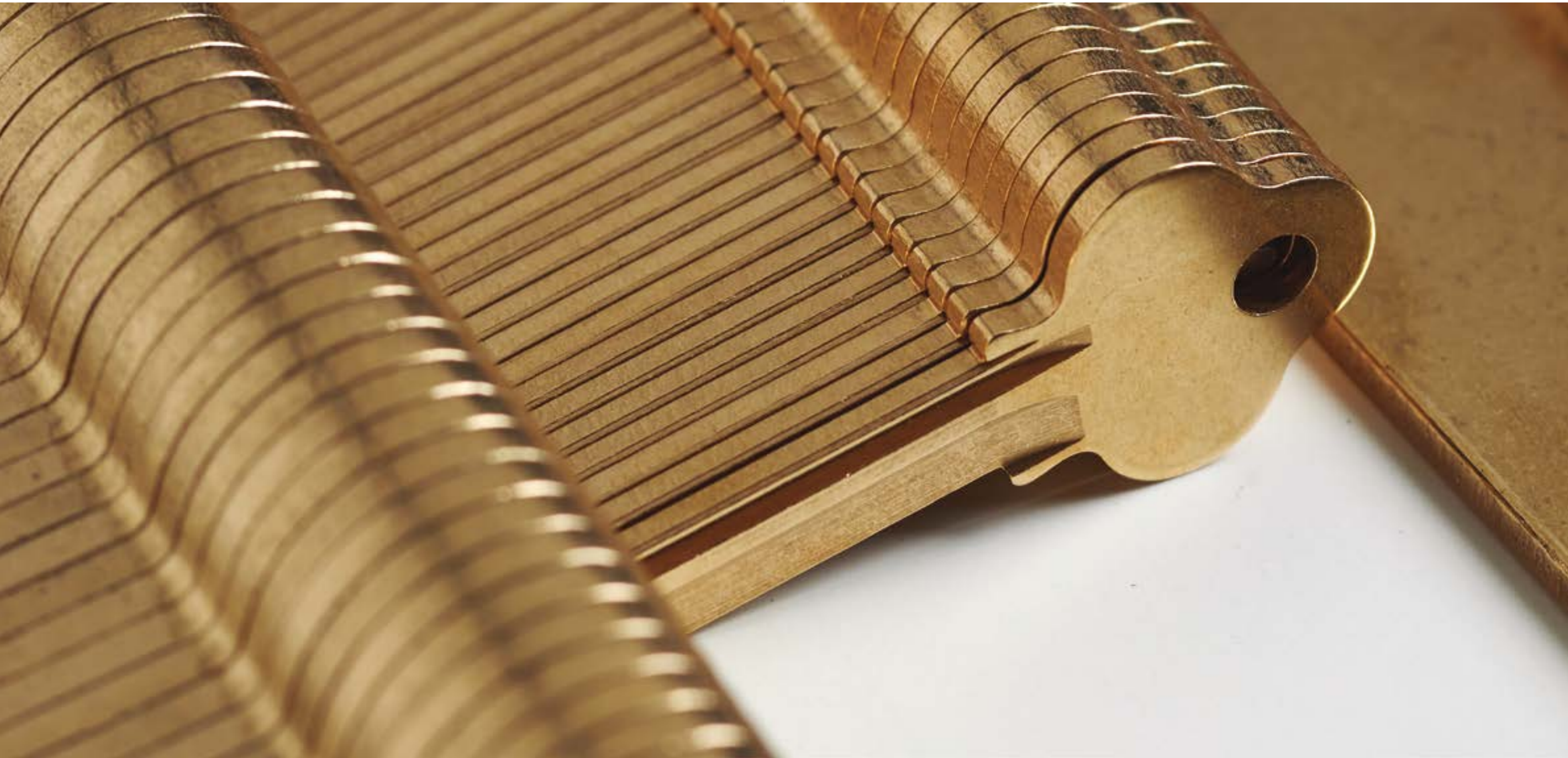



Keys

JMA KEYS. CATALOGUE

Llaves JMA. Catálogo
JMA giltzak. Katalogoak
Clés JMA. Catalogue
JMA-Schlüssel Katalog
Chaves JMA. Catálogo
Klucze JMA. Katalog



Family keys

Familias de llaves



K01 01 – 122
CYLINDER AND SPECIAL KEYS

Llaves de serreta y especiales
Serreta motako giltzak eta bereziak
Clés plates et spéciales
Profilylinder- und Spezialschlüssel
Chaves de serreta e especiais
Klucze nacinane i specjalne



K02 123 – 143
DIMPLE KEYS

Llaves de puntos
Puntuen giltzak
Clés à points
Bohrmuldenschlüssel
Chaves de pontos
Klucze nawiercane



K03 145 – 147
TUBULAR KEYS

Llaves tubulares
Hodi formako giltzak
Clés tubulaires
Stiftzylinderschlüssel
Chaves tubulares
Klucze rurkowe



K04 149 – 367
VEHICLE KEYS + BLADES / KRC

Llaves de vehículos + Almas /KRC
Ibilgailuen giltzak + Espadinak / KRC
Clés de voitures + Lames / KRC
Fahrzeugschlüssel + Schlüsselbärte /KRC
Chaves de automóveis + Espadilhas /KRC
Llaves de vehículos + Almas /KRC



K05 369 – 370
SNAP LOCK KEYS

Llaves de cierre
Ixte Giltzak
Clés de fermeture
Absperrhähne
Chaves de fecho
Klucze Nasadowe



K06 371 – 379
CROSS - SHAPED KEYS

Llaves de cruz
Gurutze motako giltzak
Clés cruciformes
Kreuzbartschlüssel
Chaves de cruz
Klucze krzyżowe



K07 381 – 453
MORTICE KEYS

Llaves de Gorja
Gorja motako giltzak
Clés à gorge
Tresor-Schlüssel
Chaves de gorja
Klucze zasuwowe



K08 455 – 458
WARDROBE KEYS

Llaves artísticas
Giltza artistikoak
Clés artistiques/de style
Artísticas
Chaves artísticas
Klucze ozdobne



K09 459 – 460
LIFT AND MAIL BOX KEYS

Llaves para casillas
Kutxatilarako giltzak
Clés pour casiers
Künstlerische Schlüssel
Chaves para caixas
Klucze do szafek

Distinctive keys*

Llaves especiales



COINED

Grabado
Grabatua
Gravure
Gravieren
Gravação
Frezowane



ALUMINIUM

Aluminio
Aluminioa
Aluminium
Aluminium
Alumínio
Aluminium



WINDCOLOR



FASHION**

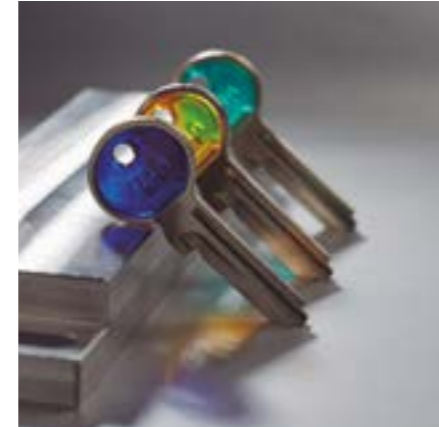

COLORMATIC

* **Check References.** Consultar Referencias. Erreferentziak Kontsultatu. Voir Références. Referenzen Konsultieren. Consultar referências. Sprawdź referencje.

** **Customizable models.** Modelos personalizables. Modelo pertsonalizatuak. Modelos personalizables. Modèles personnalisables. Modelos Personalizáveis. Konfigurowalne modele.



CYLINDER AND SPECIAL KEYS

Llaves de serreta y especiales
Serreta motako giltzak eta bereziak

Clés plates et spéciales
Profilylinder- und Spezialschlüssel

Chaves de serreta e especiais
Klucze naciane i specjalne

FOR: 45®		FOR: 303®		FOR: 333®	

FOR: 3M®	FOR: A.M. BARAS®	FOR: ABA®	FOR: ABC®	

FOR: ABC®		FOR: ABLOY®			

FOR: ABLOY®	FOR: ABSA®			

FOR: ABSA®		FOR: ABUS®		

FOR: ABUS®				

Concerning the marks and commercial denominations see legal warning.
 Concerniente a las marcas y denominaciones comerciales ver aviso legal.
 Marka eta izendapen komertzialiei dagokienez, ikus lege-oharra.
 Concernant les marques et dénominations commerciales voir la note dans l'index.

JMA® Opening the future

JMA® Opening the future

Beziehen auf die marke und handelsname sehen sie die notiz im Impressum.
 Relativamente às marcas e denominações comerciais, ver aviso legal.
 Jeśli chodzi o znaki i nazwy handlowe, patrz Informacje prawne.

FOR: ABUS®

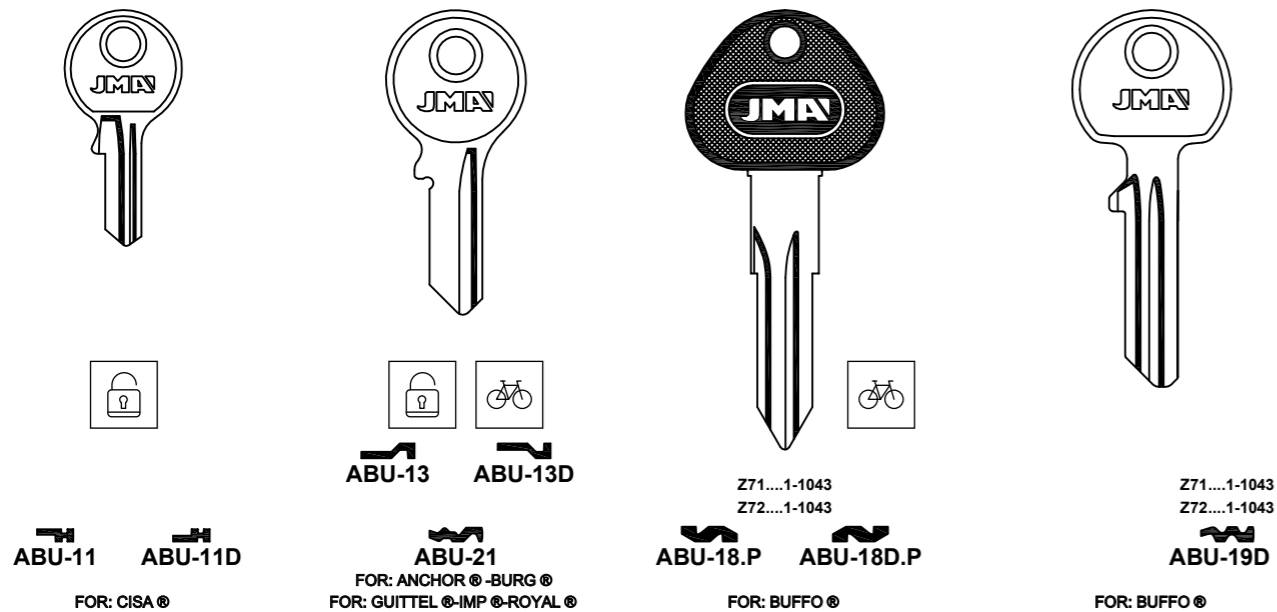

FOR: ABUS®

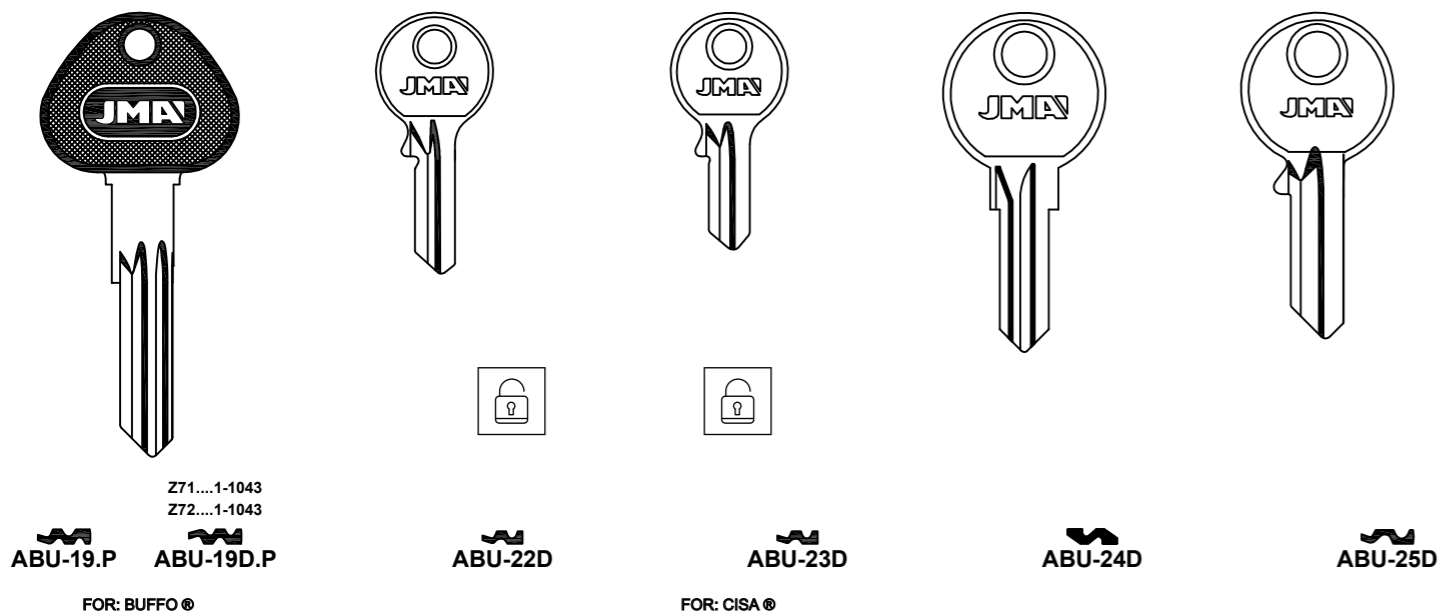

FOR: ABUS®

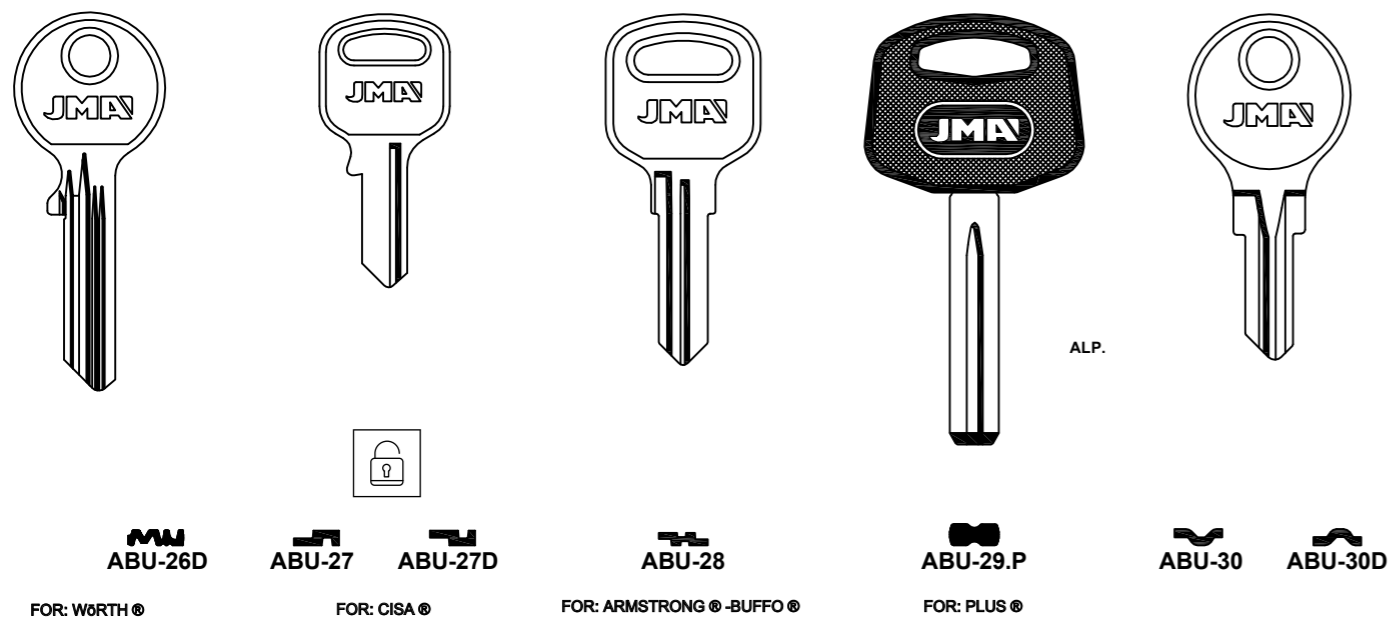

FOR: ABUS®

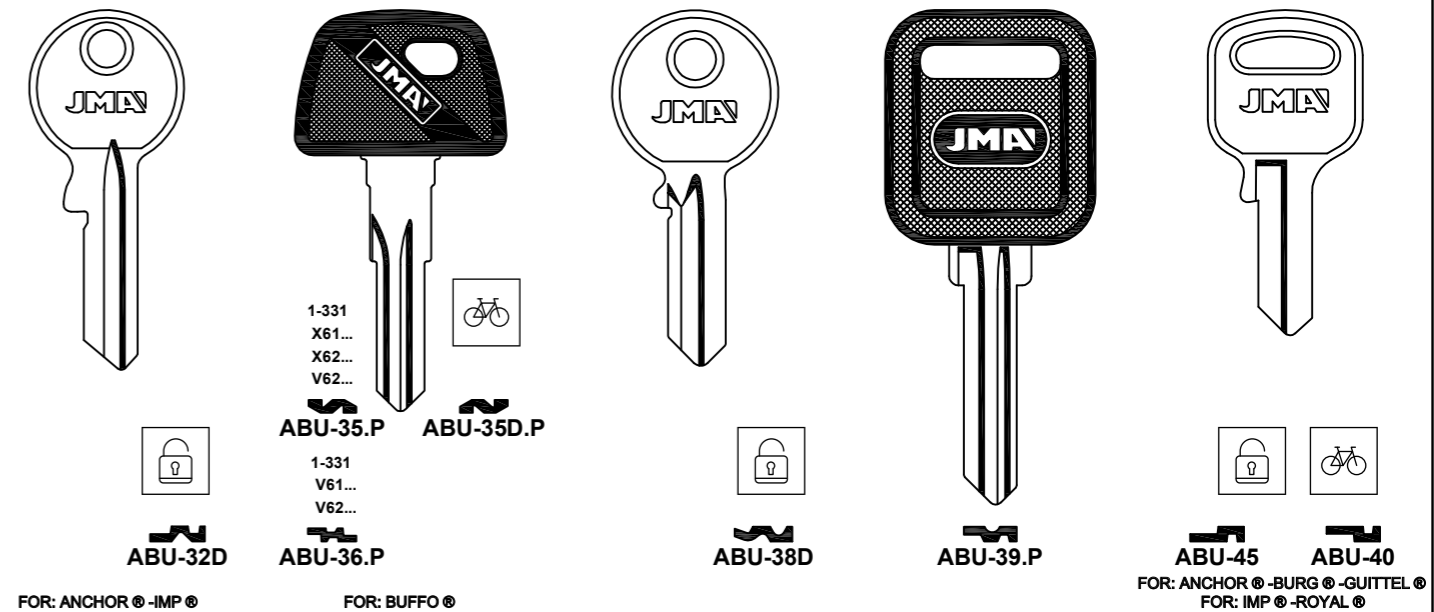

FOR: ABUS®

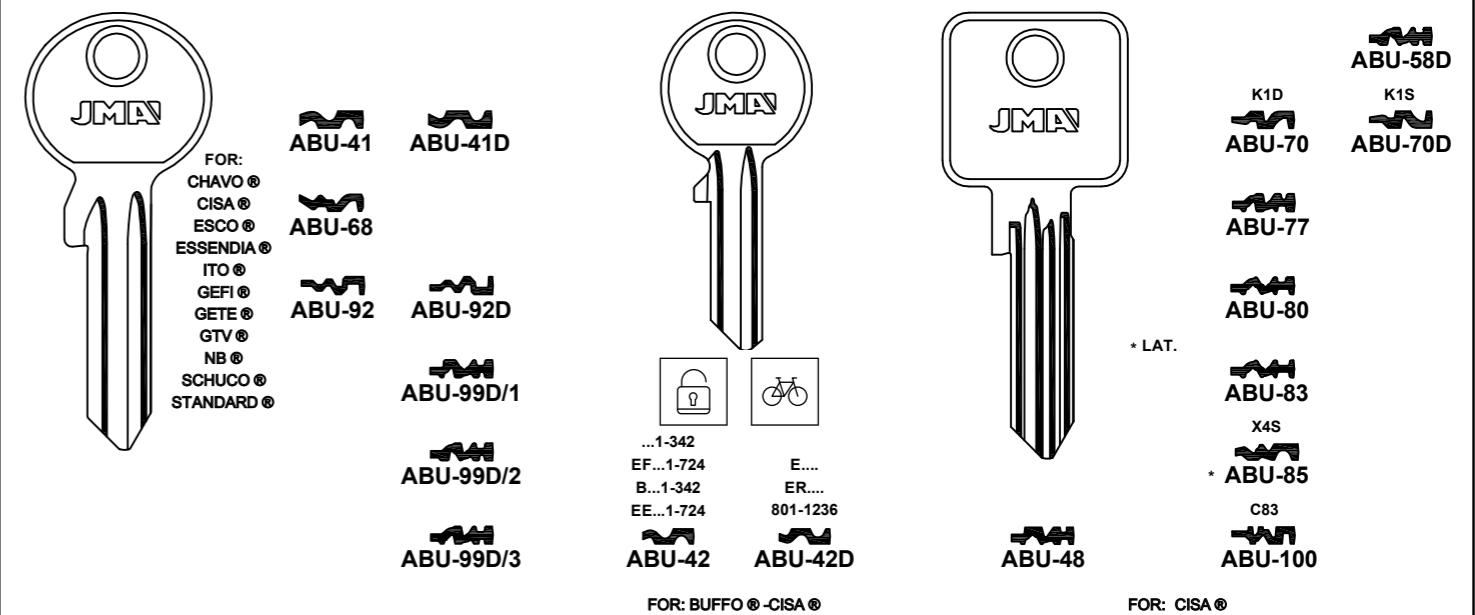

FOR: ABUS®

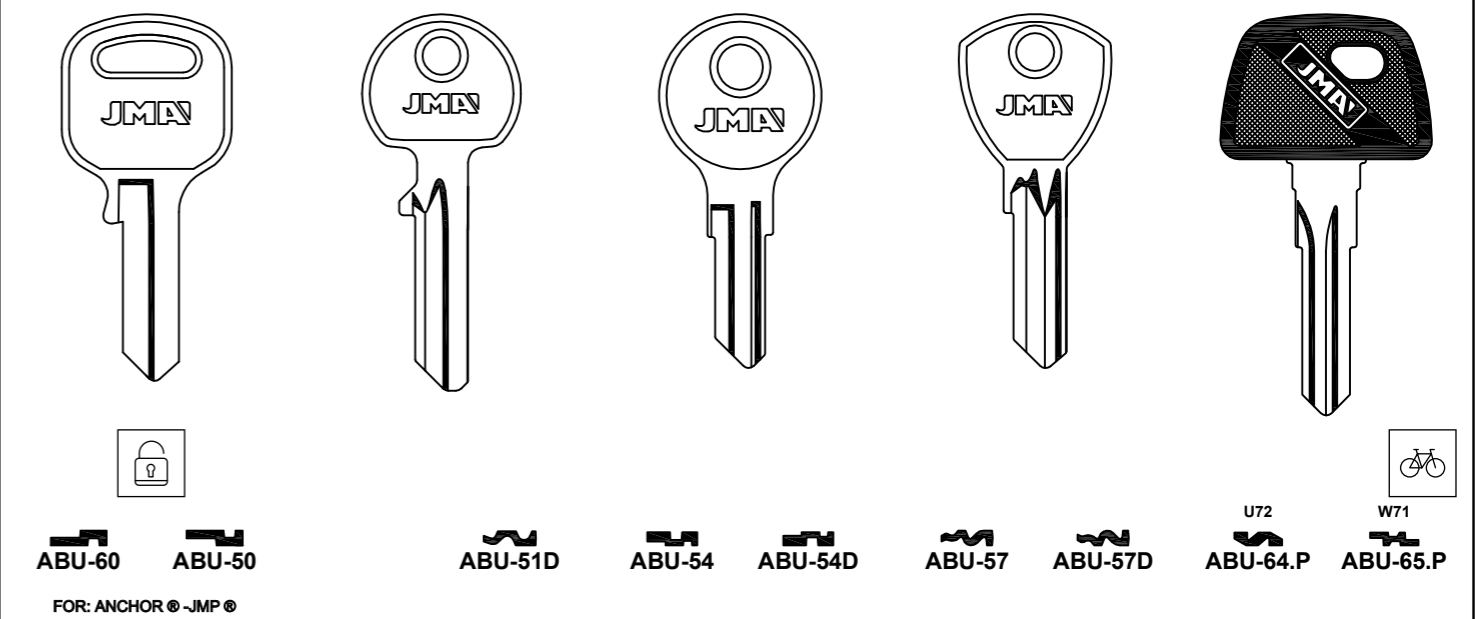

Concerning the marks and commercial denominations see legal warning.
 Concerniente a las marcas y denominaciones comerciales ver aviso legal.
 Marka eta izendapen komertzialiei dagokienez, ikus lege-oharra.
 Concernant les marques et denominations commerciales voir la note dans l'index.

JMA Opening the future

JMA Opening the future

Beziehen auf die Marke und Handelsname sehen Sie die Notiz im Impressum.
 Relativamente às marcas e denominações comerciais, ver aviso legal.
 Jeśli chodzi o znaki i nazwy handlowe, patrz Informacje prawne.

K01 / 5

FOR: ABUS®

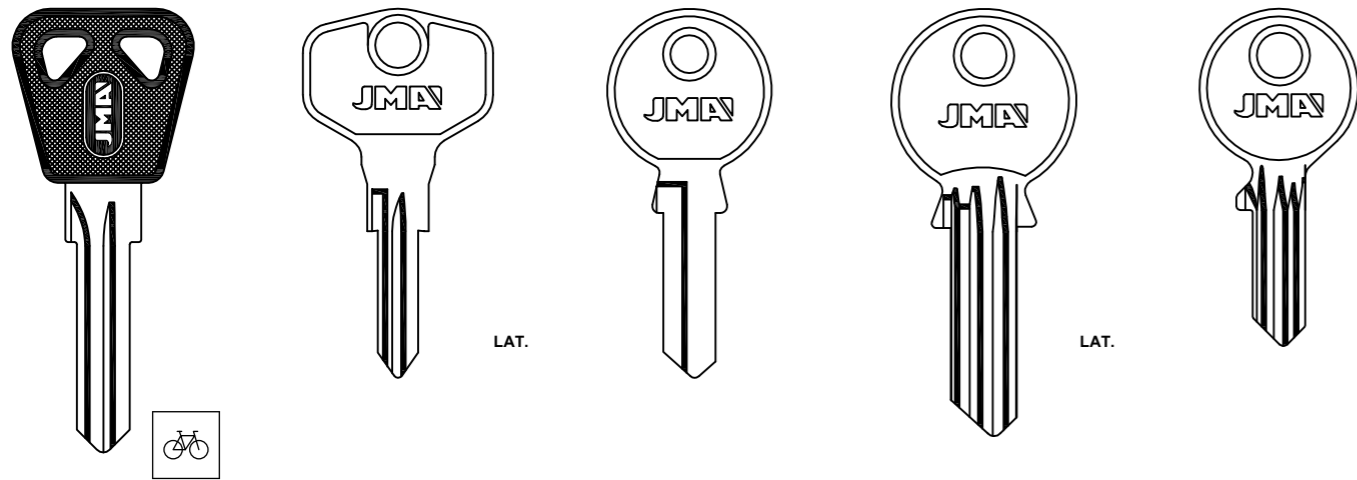

ABU-72.P

ABU-73D

ABU-75D

004
ABU-78

AL
ABU-79

FOR: GE GE®

FOR: ABUS®

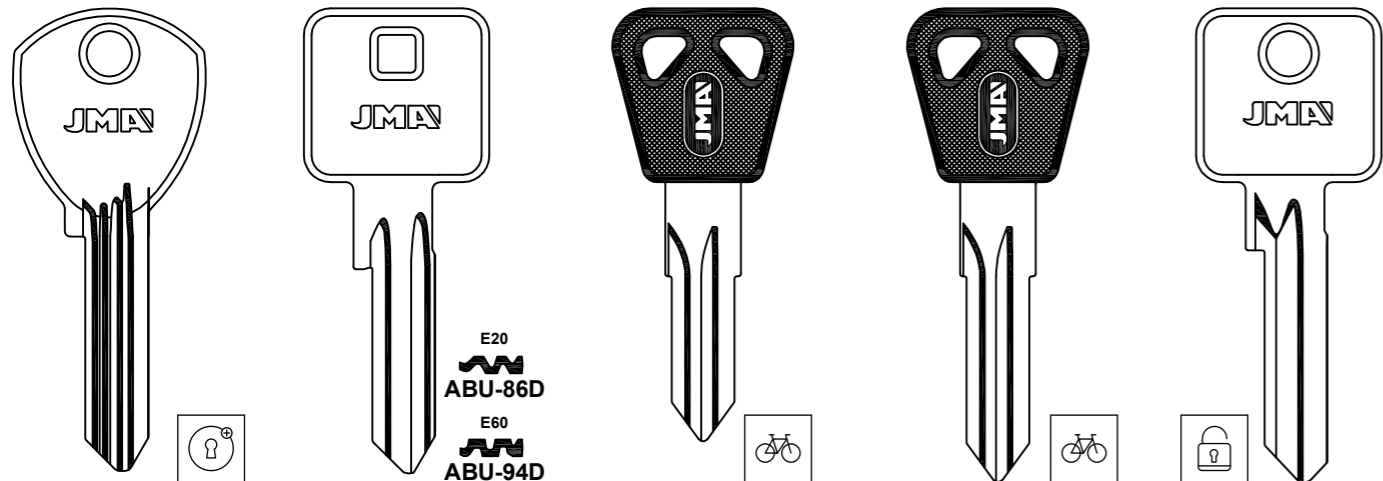

ABU-84D

ABU-17

E20
ABU-86D
E60
ABU-94D

NW52
ABU-87.P

NW72
ABU-88.P

SERIE 90/50
ABU-89D

FOR: ABUS®

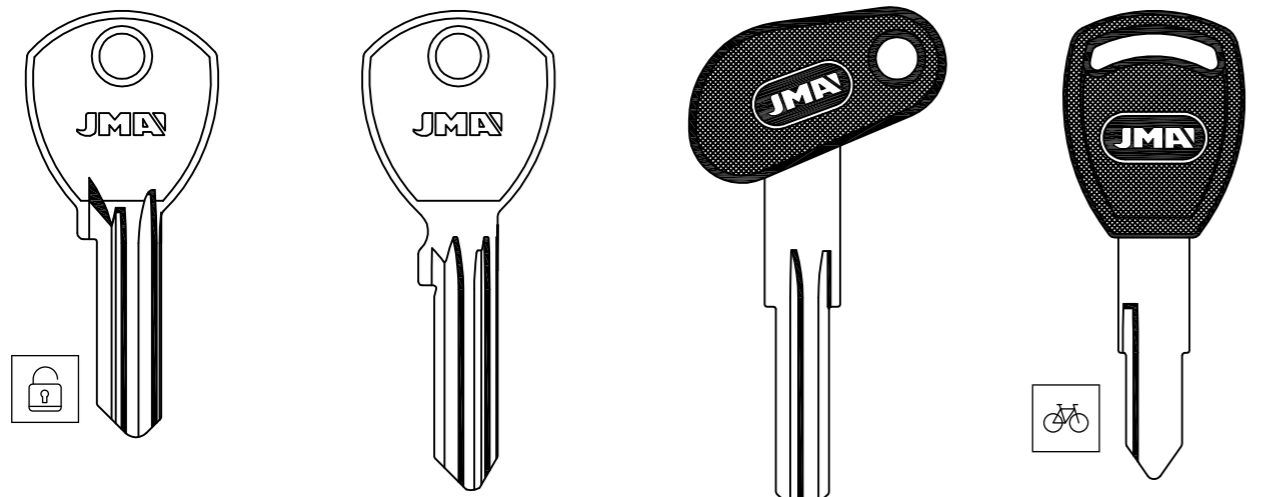

SERIE 64TI
ABU-90

ABU-93

T82
ABU-101.P

N6
ABU-103D.P

FOR: CISA®

FOR: ABUS®

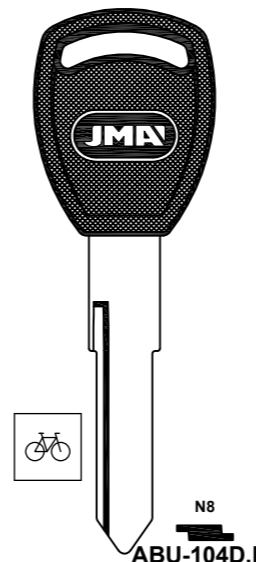

N8
ABU-104D.P

FOR: ADAMSRITE®

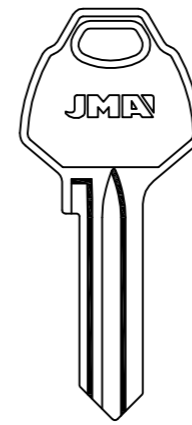

ADS-1D

FOR: AEP®

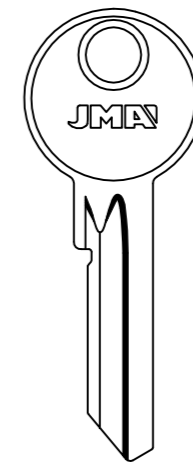

AEP-1D

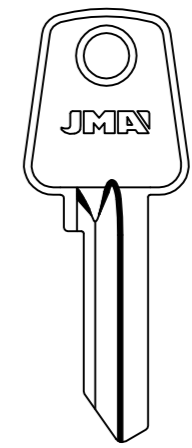

AEP-2D

FOR: AGA®



T1
AGA-11

FOR: AGA®

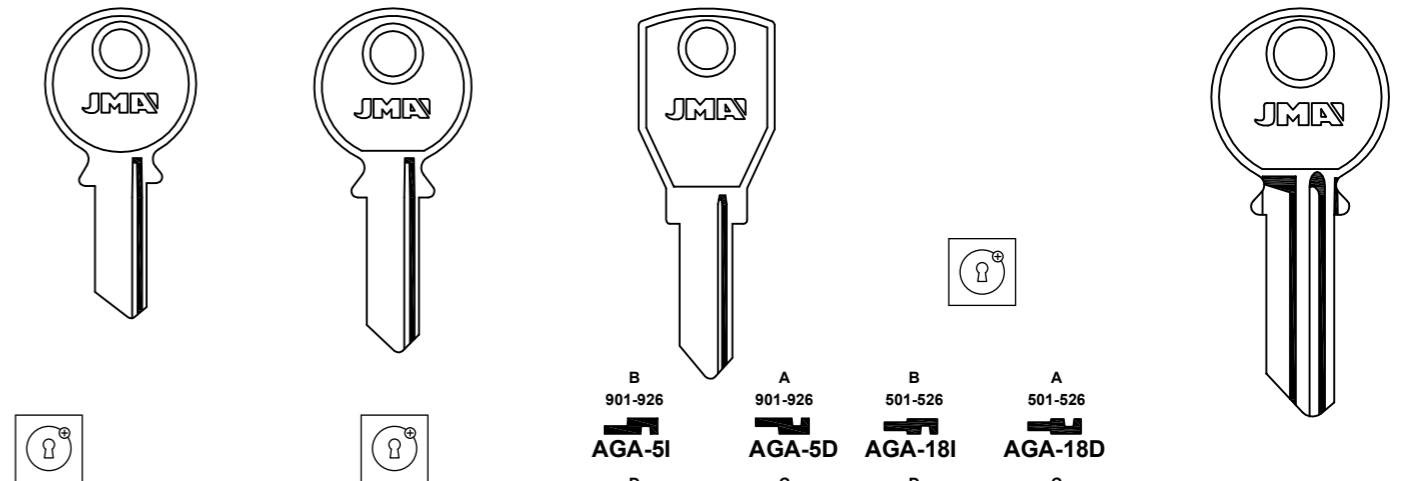

AGA-3I

AGA-4I

AGA-4D

B
901-926
AGA-5I

A
901-926
AGA-5D

B
501-526
AGA-18I

A
501-526
AGA-18D

D
901-926
AGA-6I

C
901-926
AGA-6D

D
501-526
AGA-19I

C
501-526
AGA-19D

AGA-7

FOR: FAC® -KEMEN® -KIFER® -RONEO®

FOR: MECALUX® -SUYOKA®

FOR: JOVI®

FOR: AGA®

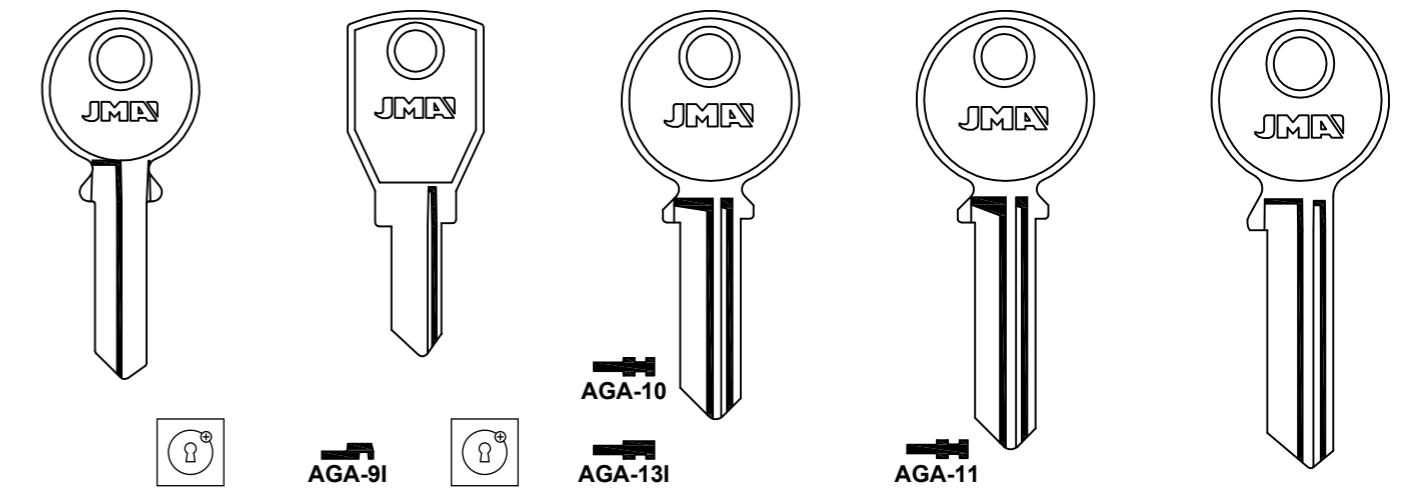

AGA-8D

AGA-9I

AGA-10

AGA-13I

AGA-11

AGA-15

FOR: GOYAL® -KEMEN®

FOR: ARREGUI® -ALFA® -GARI®

FOR: GARI®

FOR: ORENGO® -RUTALCHI® -SERRALLER®

Concerning the marks and commercial denominations see legal warning.
Concerniente a las marcas y denominaciones comerciales ver aviso legal.
Marka eta izendapen komertzialiei dagokienez, ikus lege-oharra.
Concernant les marques et dénominations commerciales voir la note dans l'index.

FOR: AGA®

AGA-16I AGA-20 P,1 P,1 11I 12I
AGA-24I AGA-24D AGA-51 AGA-52

FOR: SERRALLER®

FOR: AGA®

15I
AGA-57

FOR: AGB®

AGB-1 AGB-1D AGB-3 AGB-3D

FOR: OIAUS®

FOR: AGC®

AGD-1 AGD-2

FOR: AGE®

AGE-11 AGE-2D

FOR: AGUIA®

701 701 706 706
AG-11 AG-1D AG-6I AG-6D
703 703 708 708
AG-3I AG-3D AG-8I AG-8D
704 704 709 709
AG-4I AG-4D AG-9I AG-9D
705 705 710 710
AG-5I AG-5D AG-10I AG-10D AG-11 AG-11D

FOR: AGUT®

AGU-1D

FOR: AIZPUTE®

AIZ-1 AIZ-2D

FOR: ALDRIDGE®

AL-1I AL-2 AL-3

FOR: ASEC®

FOR: ALE®

ALE-1 ALE-1D

FOR: ALFA®

LAT.

ALF-8	ALF-8D	ALF-15	ALF-22D	ALF-29	ALF-36
ALF-7		ALF-14D	ALF-21	ALF-28	ALF-35
ALF-6		ALF-13D	ALF-20	ALF-27	ALF-34
ALF-5		ALF-12D	ALF-19	ALF-26	ALF-33
ALF-4		ALF-11D	ALF-18	ALF-25	ALF-32D
ALF-3	ALF-10	ALF-10D	ALF-17	ALF-24	ALF-31
ALF-2			ALF-9	ALF-16	ALF-23
					ALF-30

FOR: GE GE®

FOR: ALIANCA®

ALC-1D

FOR: ALPHA®

S...301-600 S...301-600

ALP-11 ALP-1D ALP-2 ALP-2D ALP-3 ALP-4D

FOR: FEB® FOR: FEB®

FOR: JD® -LINCE® -MONACOR®
FOR: SANY® -VISONIC®

Concerning the marks and commercial denominations see legal warning.
 Concerniente a las marcas y denominaciones comerciales ver aviso legal.
 Marka eta izendapen komertzialiei dagokienez, ikus lege-oharra.
 Concernant les marques et denominations commerciales voir la note dans l'index.

JMA® Opening the future

JMA® Opening the future

Beziehen auf die marke und handelsname sehen sie die notiz im Impressum.
 Relativamente às marcas e denominações comerciais, ver aviso legal.
 Jeśli chodzi o znaki i nazwy handlowe, patrz Informacje prawne.

FOR: ALPHA® ALP-5D	FOR: ALTAY® ATA-1 ATA-1D	FOR: AMARU® AMA-1 AMA-1D FOR: AL®	FOR: AMERICAN LOCK® AME-1 AME-2 LAT.
---------------------------	------------------------------------	--	---

FOR: AMERICAN LOC.® AME-4 LAT.	FOR: AMIG® 1-15 / 1-20 AMG-1 1-25 AMG-2D 1-30 AMG-3D 1-40 AMG-4D 1-50 AMG-5D				
--	--	--	--	--	--

FOR: AMIG® MOD.9700 AMG-13D FOR: FAC® -GAON® -KALE® -TURSAN®	FOR: ANCHOR® ANC-1D FOR: ANKERSLOT®	FOR: ANKER® K...111-888 ... K... 1011-7077 E... F... B... 1-2-3-4-5-6-7 A ANK-1 A ANK-2 FOR: ANCHOR® -LITTO® -ODA® FOR: ODA®
---	---	--

FOR: ANKER® ANK-3 FOR: ODA®					 ANK-4	 K...111-888 ... K... 1011-7077 E... F... B... 1-2-3-4-5-6-7 ANK-6	 ANK-17 ANK-65	 K...111-888 ... K... 1011-7077 E... F... B... 1-2-3-4-5-6-7 ANK-47D
---------------------------------------	--	--	--	--	-----------	---	----------------------	---

FOR: ANANTAR® ANA-1 ANA-1D FOR: VEGA®	FOR: APECS® AP-2D FOR: APEX® - APEKS®	FOR: ARCU® ALP. A ARC-17.P B ARC-17D.P	FOR: AREL® ARE-1D	FOR: ARFE® ARFE-1I ARFE-1D
--	---	---	--------------------------	--------------------------------------

FOR: ARFE® ARFE-3D	FOR: ARMSTRONG® ARN-1 ARN-2 ARN-2D ARN-3 ARN-3D FOR: ABUS®			FOR: AROUCA® ARO-1D
---------------------------	--	--	--	----------------------------

Concerning the marks and commercial denominations see legal warning.
 Concerniente a las marcas y denominaciones comerciales ver aviso legal.
 Marka eta izendapen komertzialiei dagokienez, ikus lege-oharra.
 Concernant les marques et dénominations commerciales voir la note dans l'index.

JMA Opening the future

JMA Opening the future

Beziehen auf die marke und handelsname sehen sie die notiz im Impressum.
 Relativamente às marcas e denominações comerciais, ver aviso legal.
 Jeśli chodzi o znaki i nazwy handlowe, patrz Informacje prawne.

FOR: ARREGUI®

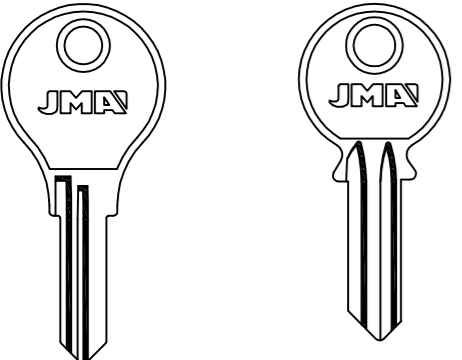

ARR-1
ARR-2
ARR-3
ARR-8

AR-1D
AR-4IP
AR-4DP

FOR: INDAUX®

FOR: ARROW®

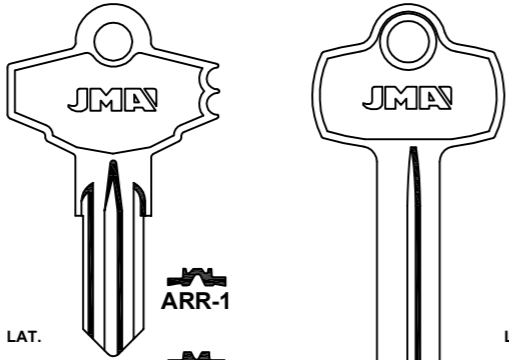

* LAT.
LAT.

ARR-7D
ARR-9D

D
C

ARR-1D

FOR: ARSENEVSK®

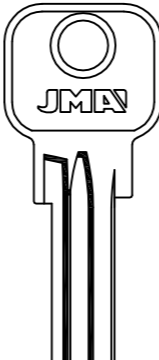

ARS-1D

FOR: DOMINION LOCK®-FORT®-LG®

FOR: ASEC®

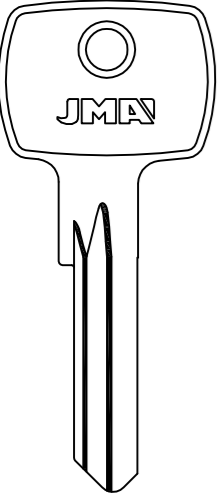

ASC-1D

FOR: ASIA®

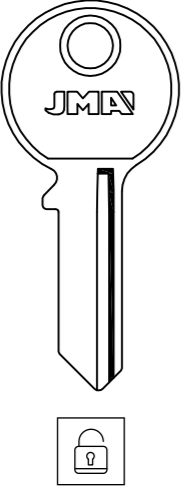

ASI-1

FOR: CINA®

FOR: ASPA®

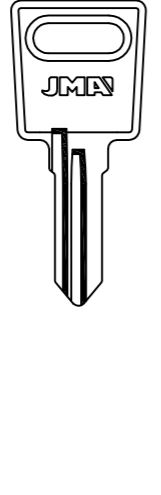

ASP-1D

FOR: ASSA®

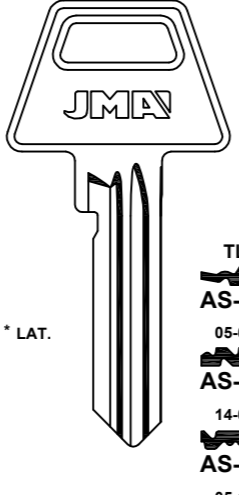

* LAT.

TL

AS-4D
AS-5D
AS-6D
AS-7D

14-09
AS-8D
14-25
AS-9D

05-04
AS-5D
14-01
AS-6D
05-13
AS-7D

11-01
AS-13D
11-12
AS-14D
11-32
AS-15D
11-08
AS-16D
05-14
AS-18D
11-33
AS-11D
11-14
AS-12D
TM
AS-25D
* AS-28

FOR: ASSA®

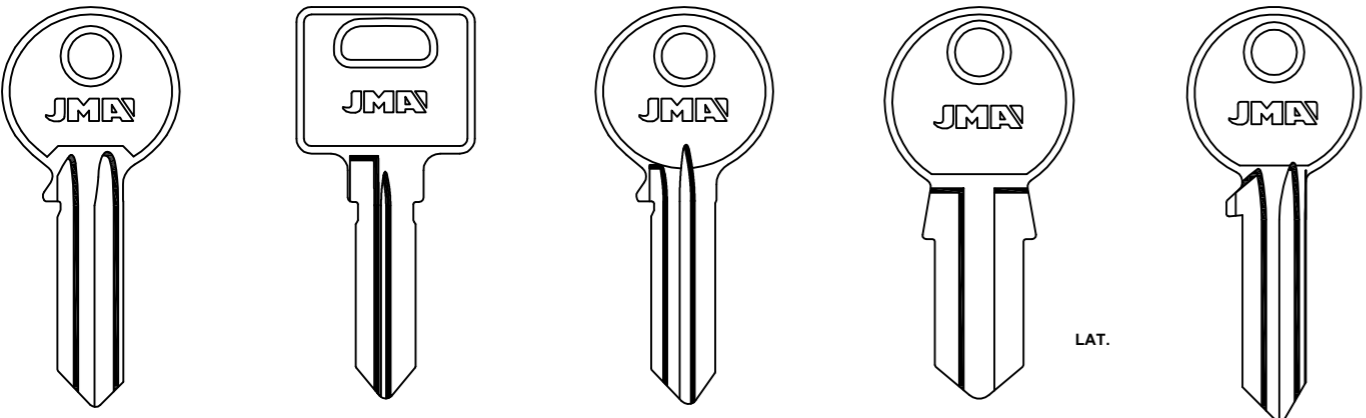

FOR: ABC®
0 AL 9

21301
AS-3I

21201
AS-3D

21....
0001-9999
AS-19D

AS-20D

AS-22

AS-23

AS-23D

LAT.

FOR: TEKA®

FOR: ASSA®

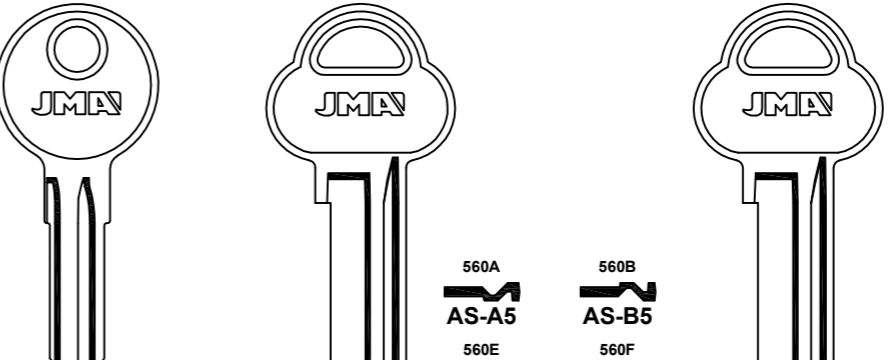

AS-30D

28,4 mm.

560A
AS-A5
560E
AS-E5
560M
AS-M5
560P
AS-P5

560B
AS-B5
560F
AS-F5
560G
AS-G5
560N
AS-N5

34,5 mm.

760A
AS-A7
760E
AS-E7
760L
AS-L7
760M
AS-M7
760P
AS-P7
760S
AS-S7

760B
AS-B7
760F
AS-F7
760K
AS-K7
760G
AS-G7
760N
AS-N7
760R
AS-R7

760RK
AS-RK7
760RC
AS-RC7
760RE
AS-RE7
760RG
AS-RG7
760RH
AS-RH7

760RA
AS-RA7
760RB
AS-RB7
760RD
AS-RD7
760RF
AS-RF7
760RN
AS-RN7

FOR: ASSA®

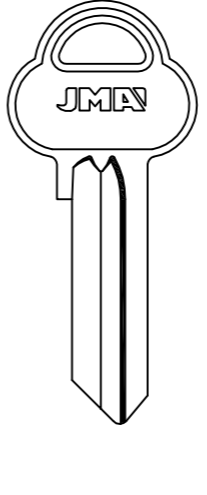

29,7 mm.

560AK
AS-AK5
560AL
AS-AL5
560AM
AS-AM5
560BK
AS-BK5

560EK
AS-EK5
560EL
AS-EL5
560EM
AS-EM5
560FK
AS-FK5

560DK
AS-DK5
560DL
AS-DL5
560DM
AS-DM5
560FK
AS-FK5

560GK
AS-GK5
560GL
AS-GL5
560GM
AS-GM5
560MM
AS-MM5

560NN
AS-NN5
560V
AS-V5
560U
AS-U5

560T
AS-T5
560W
AS-W5

FOR: ASSA®

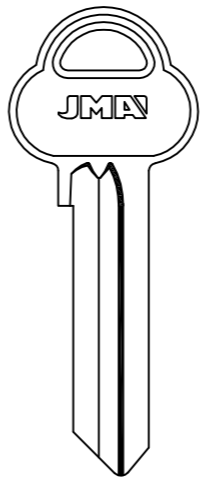

35,7 mm.

760AK
AS-AK7
760AL
AS-AL7
760AM
AS-AM7
760BK
AS-BK7
760BL
AS-BL7

760EK
AS-EK7
760EL
AS-EL7
760EM
AS-EM7
760FK
AS-FK7
760FL
AS-FL7

760DK
AS-DK7
760DL
AS-DL7
760DM
AS-DM7
760GG
AS-GG7
760KK
AS-KK7

760FM
AS-FM7
760GK
AS-GK7
760GL
AS-GL7
760GM
AS-GM7
760MM
AS-MM7

760D
AS-D7
760U
AS-U7
760V
AS-V7
760RR
AS-RR7

760H
AS-H7
760W
AS-W7
760T
AS-T7
760X
AS-X7

760NN
AS-NN7
760PP
AS-PP7
760SS
AS-SS7
760Z
AS-Z7

Concerning the marks and commercial denominations see legal warning.
 Concerniente a las marcas y denominaciones comerciales ver aviso legal.
 Marka eta izendapen komertzialiei dagokienez, ikus lege-oharra.
 Concernant les marques et dénominations commerciales voir la note dans l'index.

JMA® Opening the future

JMA® Opening the future

Beziehen auf die marke und handelsname sehen sie die notiz im Impressum.
 Relativamente às marcas e denominações comerciais, ver aviso legal.
 Jeśli chodzi o znaki i nazwy handlowe, patrz Informacje prawne.



FOR: ASSA®

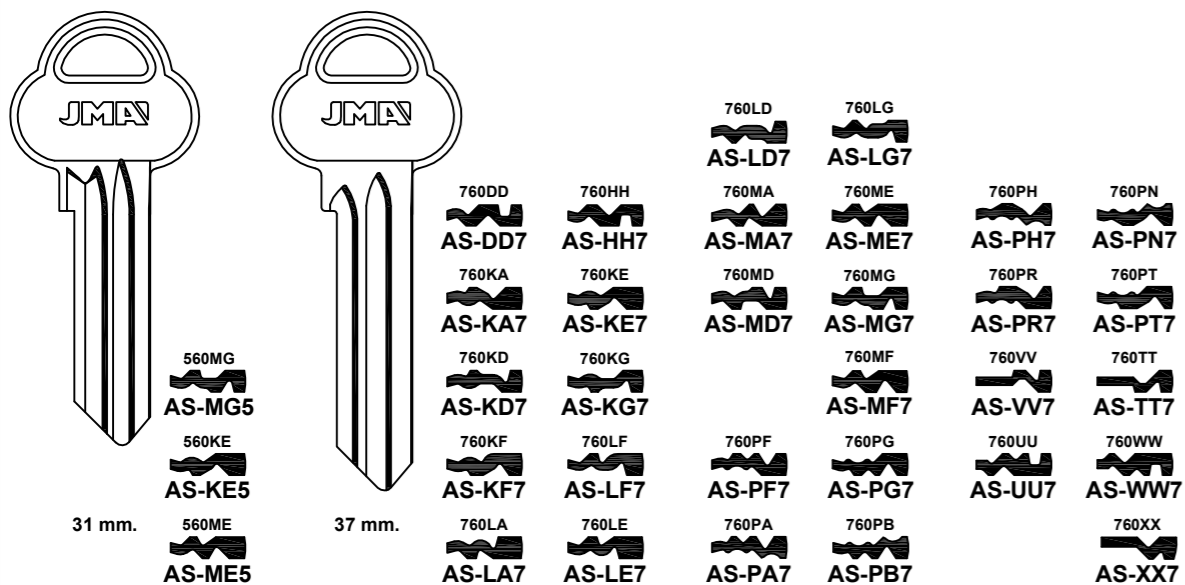

FOR: ATLAS®

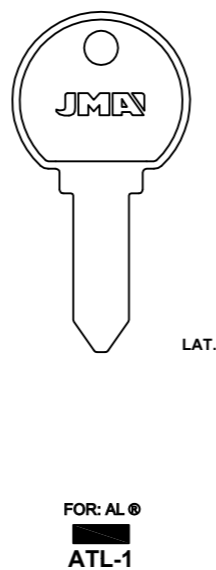

FOR: AZBE®

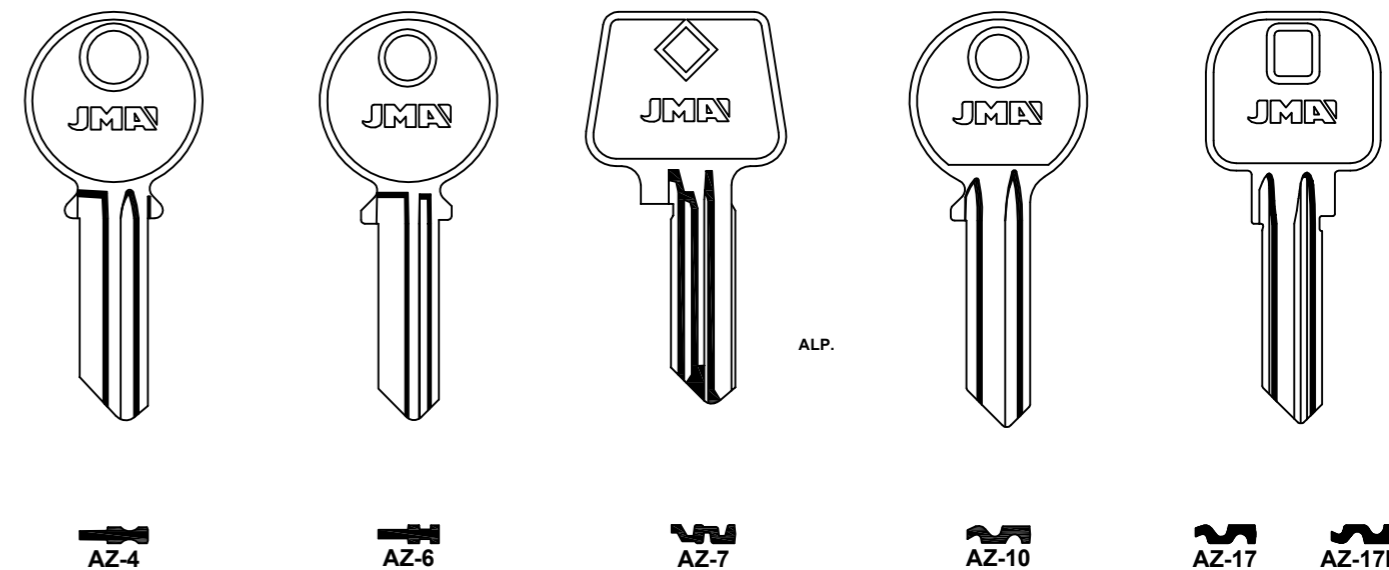

FOR: AUMON®

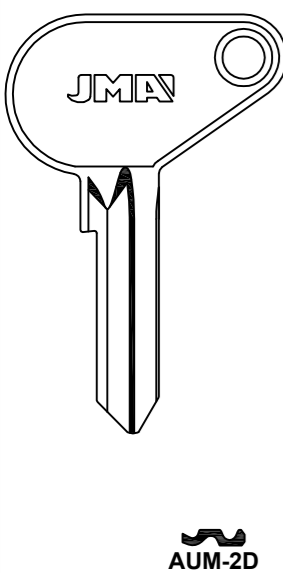

FOR: AVANGARD®

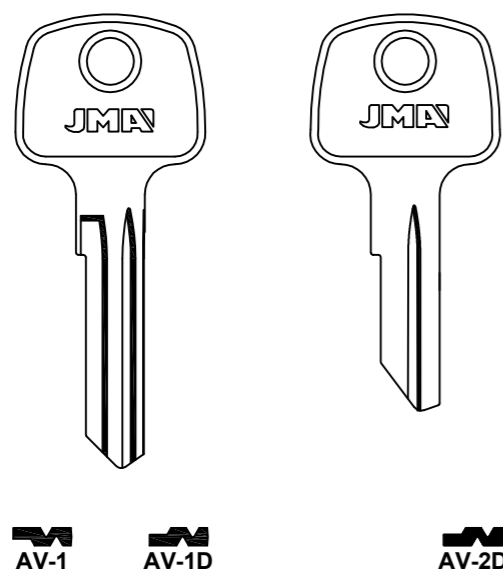

FOR: AXA®

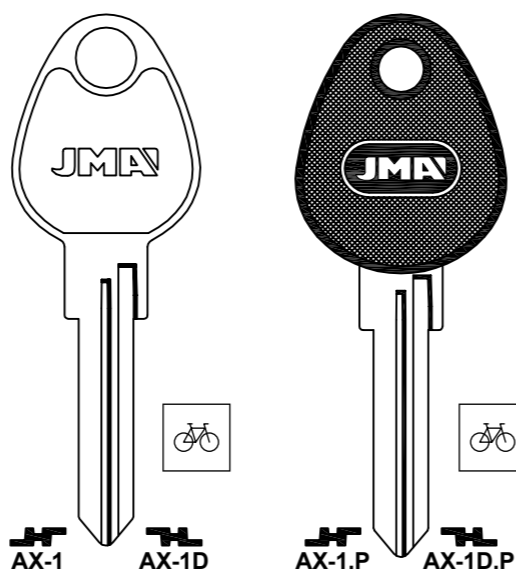

FOR: AZBE®

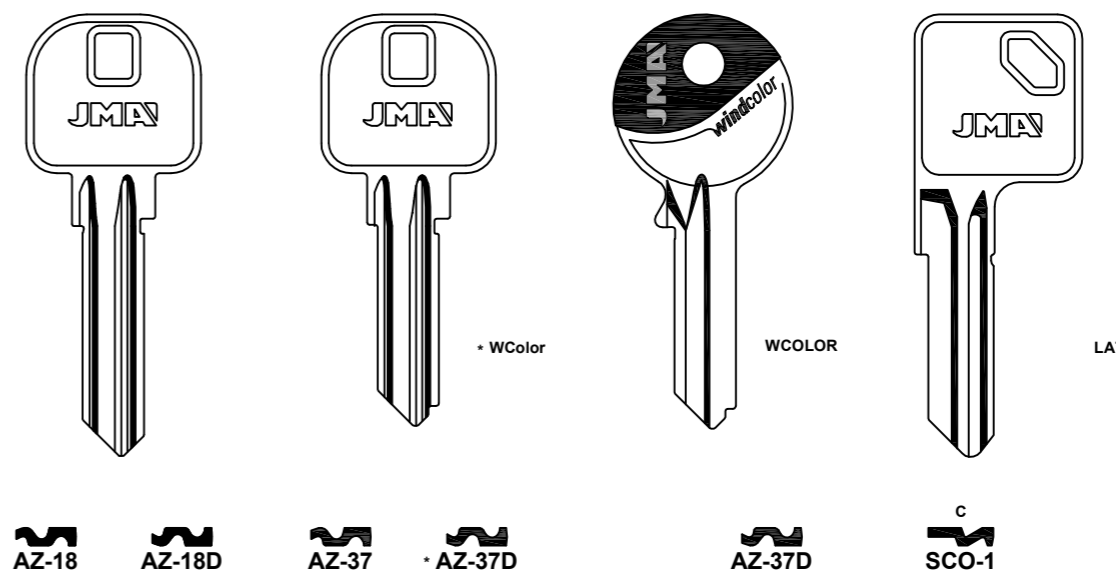

FOR: AZKOYEN®

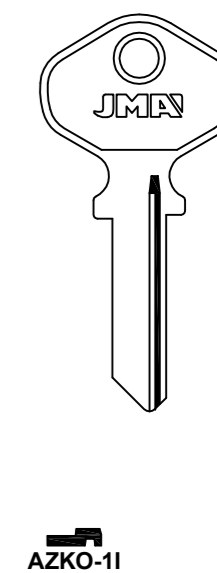

FOR: AXA®

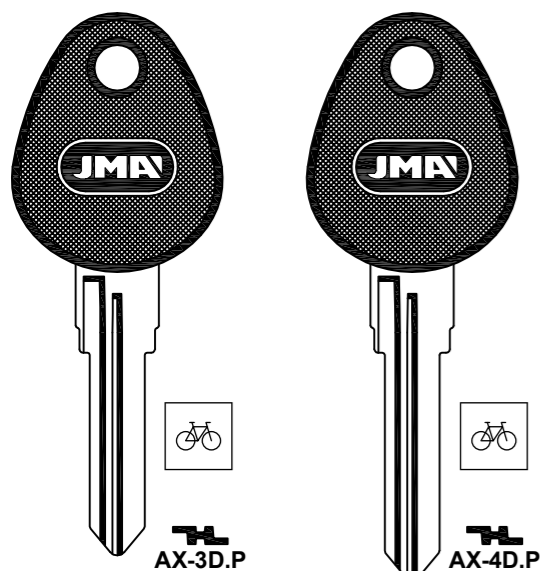

FOR: AZBE®

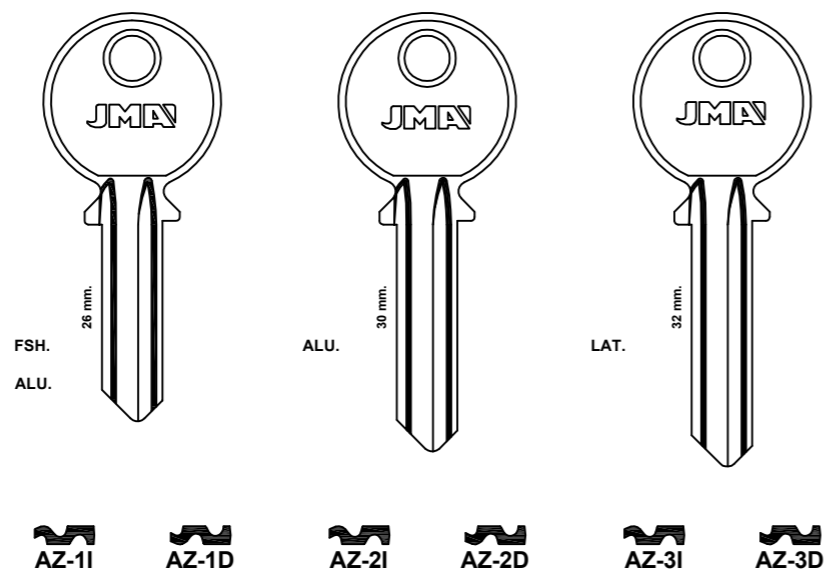

FOR: B+D®

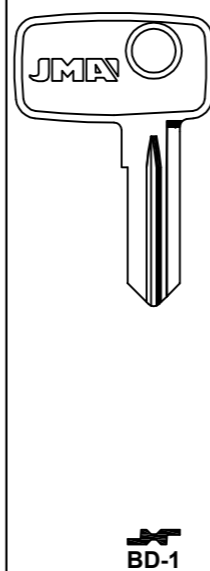

FOR: BAB®

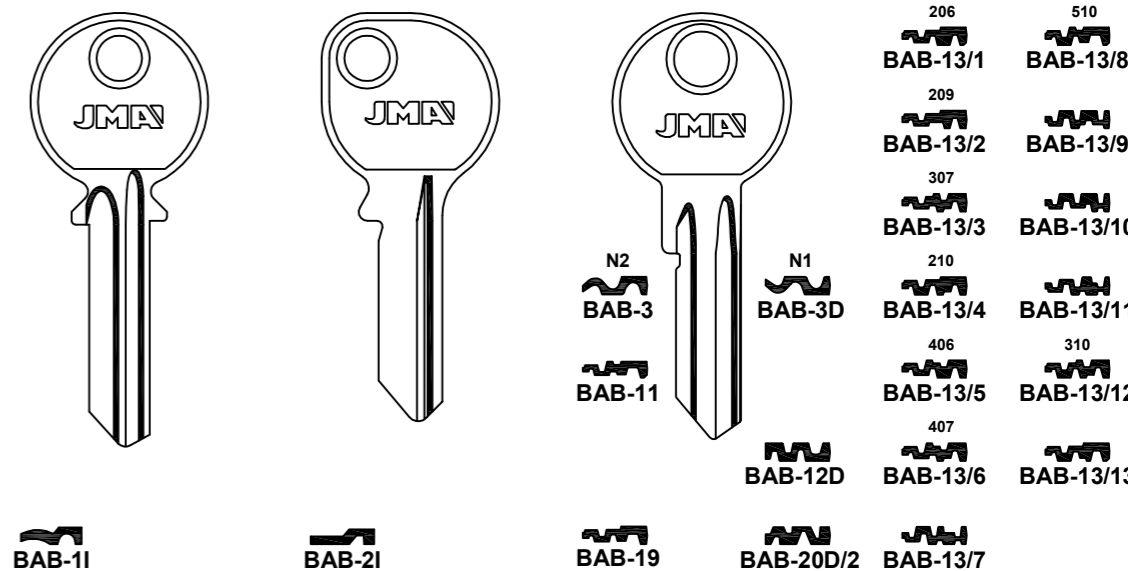

Concerning the marks and commercial denominations see legal warning.
 Concerniente a las marcas y denominaciones comerciales ver aviso legal.
 Marka eta izendapen komertzialiei dagokienez, ikus lege-oharra.
 Concernant les marques et denominations commerciales voir la note dans l'index.

JMA® Opening the future

JMA® Opening the future

Beziehen auf die marke und handelsname sehen sie die notiz im Impressum.
 Relativamente às marcas e denominações comerciais, ver aviso legal.
 Jeśli chodzi o znaki i nazwy handlowe, patrz Informacje prawne.

FOR: BAB®

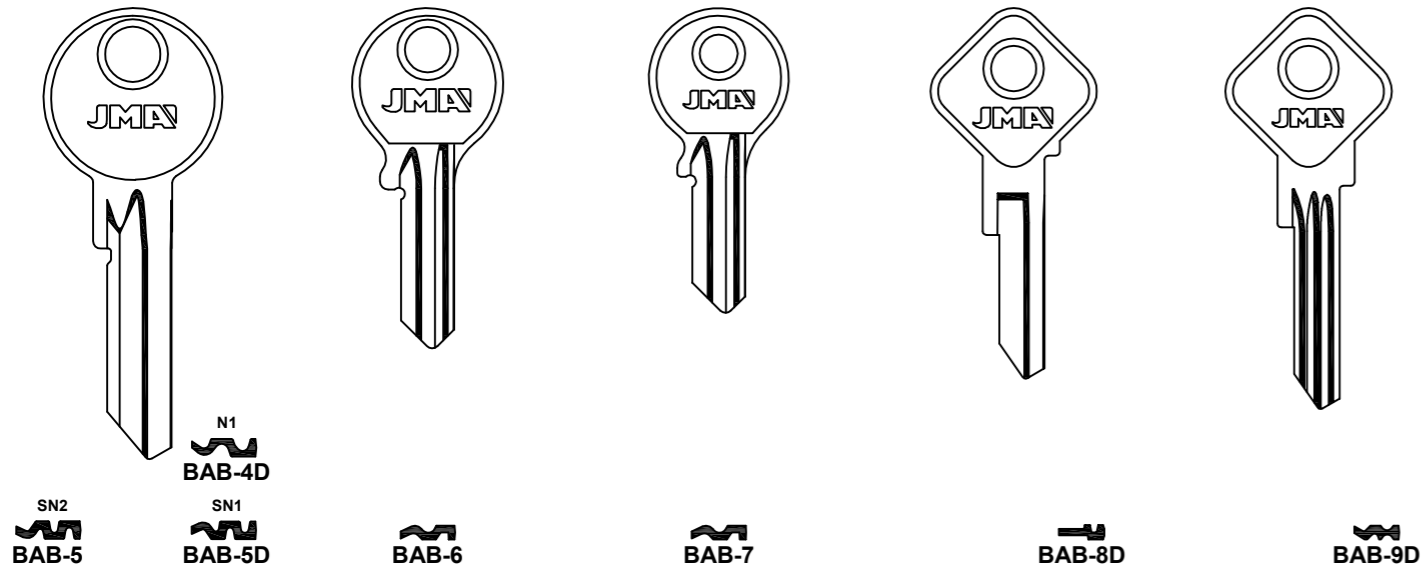

FOR: BASTA®

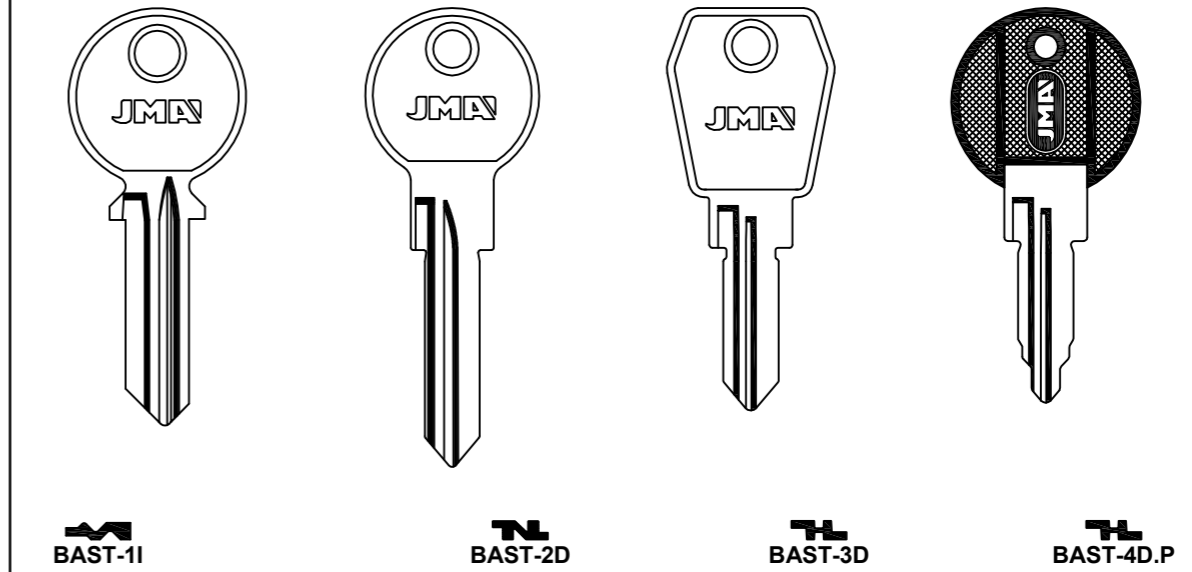

FOR: BATU®

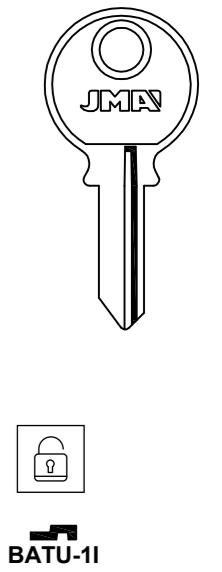

FOR: BAB®

FOR: BALTIKA®

FOR: BANHAM®

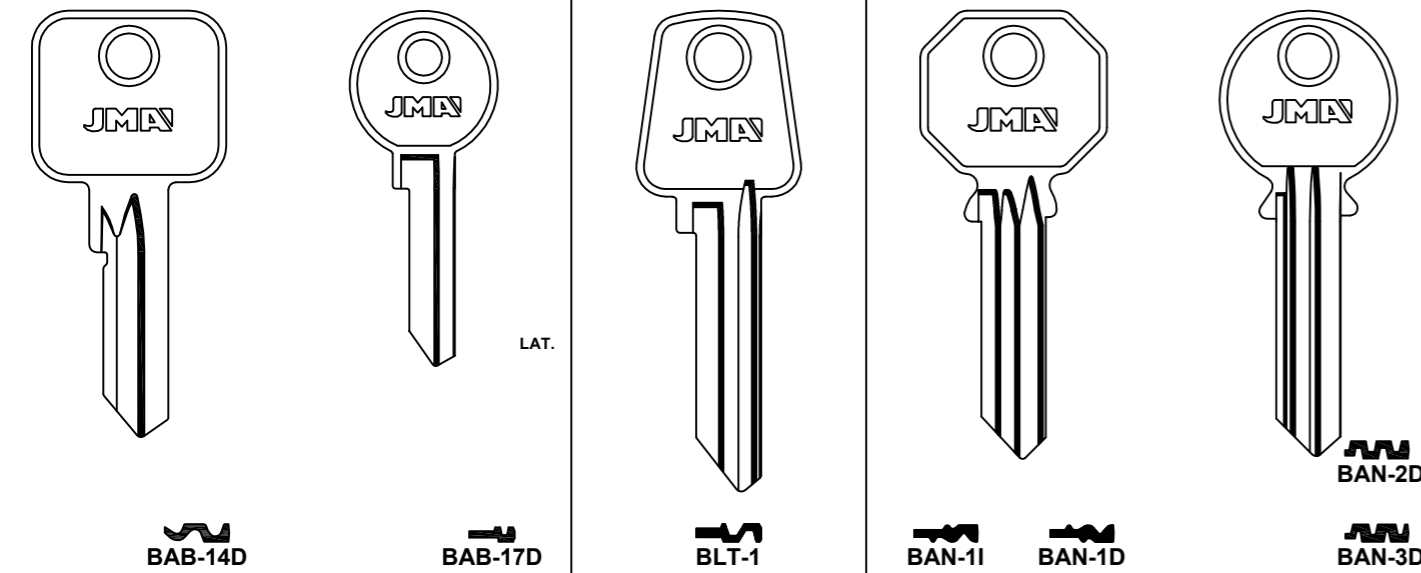

FOR: BEST®

FOR: BETA®

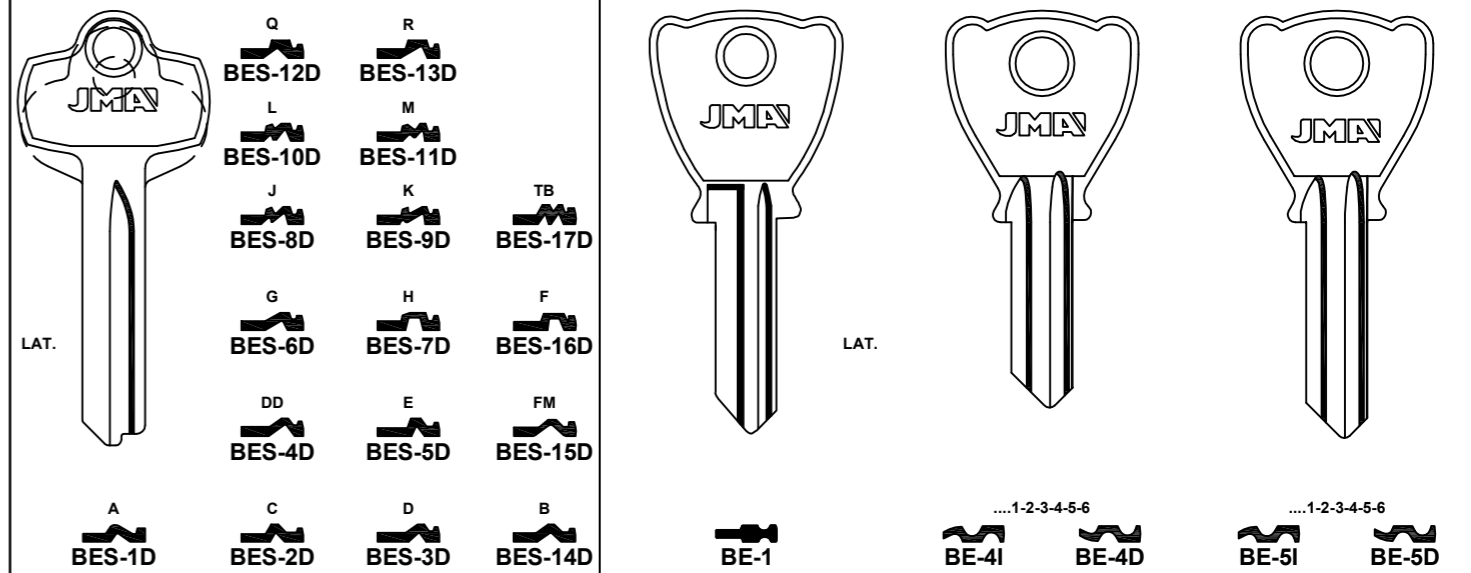

FOR: BAODELI®

FOR: BARCZ®

FOR: BASI®

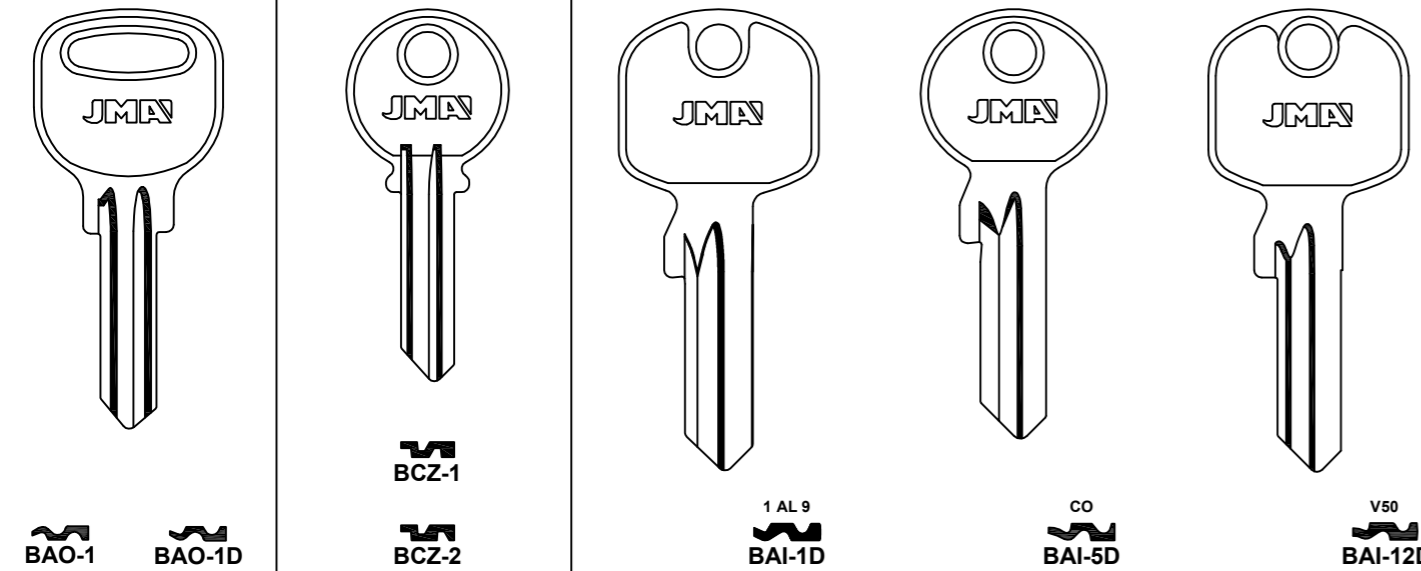

FOR: BIBERING®

FOR: BIELLE®

FOR: BIFFAR®

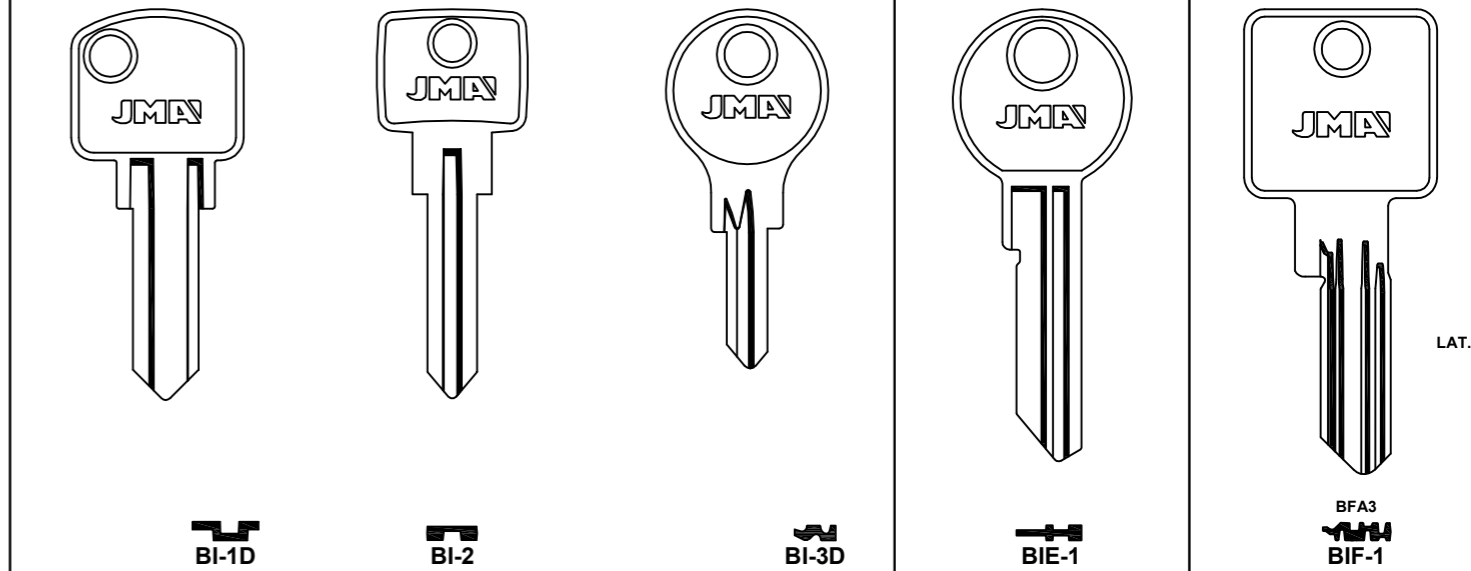

FOR: BMB®			FOR: BODA®	FOR: BOMORO®
A...201-400	A...401-600			

FOR: BRICARD®					FOR: BRUMME®
FOR: ABUS®	FOR: ABUS®				FOR: FANA®

FOR: BOMORO®	FOR: BOULTON & P.®	FOR: BRABANTIA®	FOR: BRAS®	FOR: BRASIL®
FOR: LAPORTE®-PRESTA®	FOR: RST®		ALP.	

FOR: BSS®				
FOR: BANE SEKULIĆ®	FOR: BANE SEKULIĆ®	FOR: BANE SEKULIĆ®	FOR: BANE SEKULIĆ®	FOR: BANE SEKULIĆ®-GE GE®

FOR: BRICARD®				
FOR: STREMLER®				FOR: BLOCTOUT®-INLOC®

FOR: BSS®	FOR: BTV®	FOR: BUGA®
FOR: BANE SEKULIĆ®	FOR: SADV®	FOR: ARREGUI®

Concerning the marks and commercial denominations see legal warning.
 Concerniente a las marcas y denominaciones comerciales ver aviso legal.
 Marka eta izendapen komertzialiei dagokienez, ikus lege-oharra.
 Concernant les marques et dénominations commerciales voir la note dans l'index.

JMA Opening the future

JMA Opening the future

Beziehen auf die marke und handelsname sehen sie die notiz im Impressum.
 Relativamente às marcas e denominações comerciais, ver aviso legal.
 Jeśli chodzi o znaki i nazwy handlowe, patrz Informacje prawne.

FOR: BULAT®

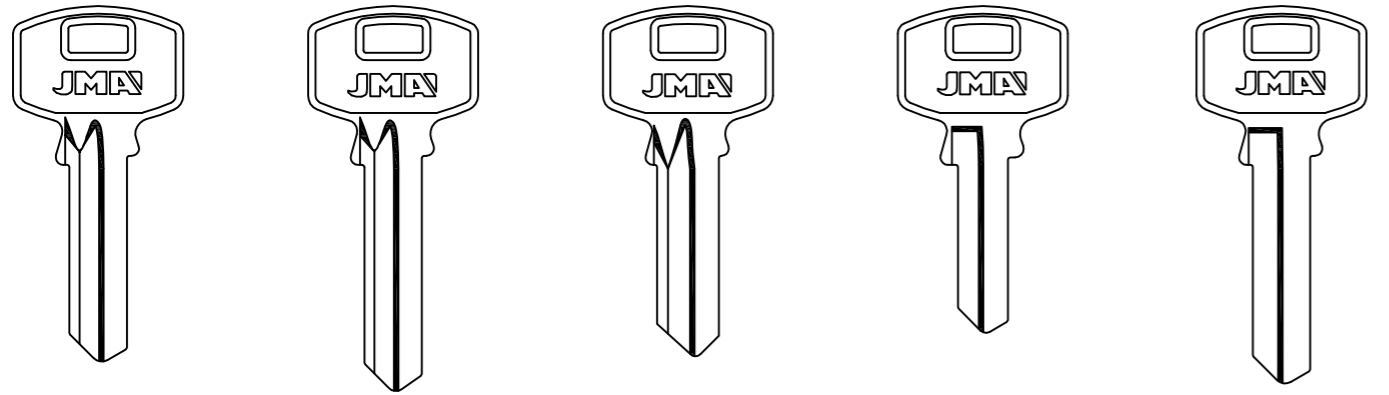

BUL-2D BUL-6D BUL-3D BUL-4D BUL-5D BUL-7D

FOR: BURG®

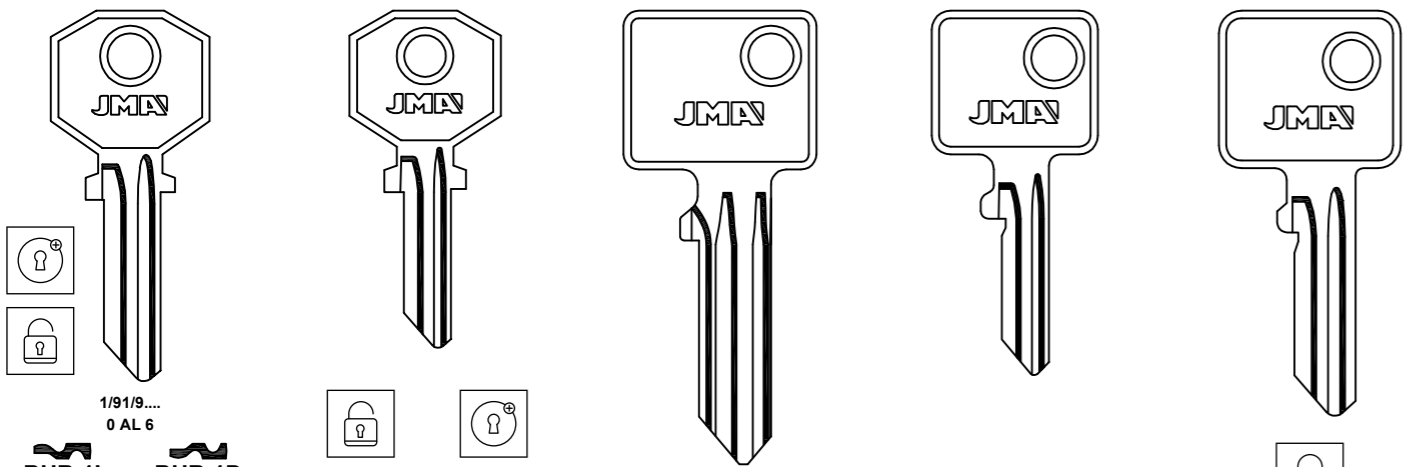

BUR-11 BUR-1D BUR-27D BUR-21 BUR-2D BUR-3 BUR-3D BUR-4 BUR-4D BUR-5 BUR-5D
 1/91/9... 0 AL 6
 1/91/9... 0 AL 6
 FOR: MELSMETALL® FOR: MELSMETALL®

FOR: BURG®

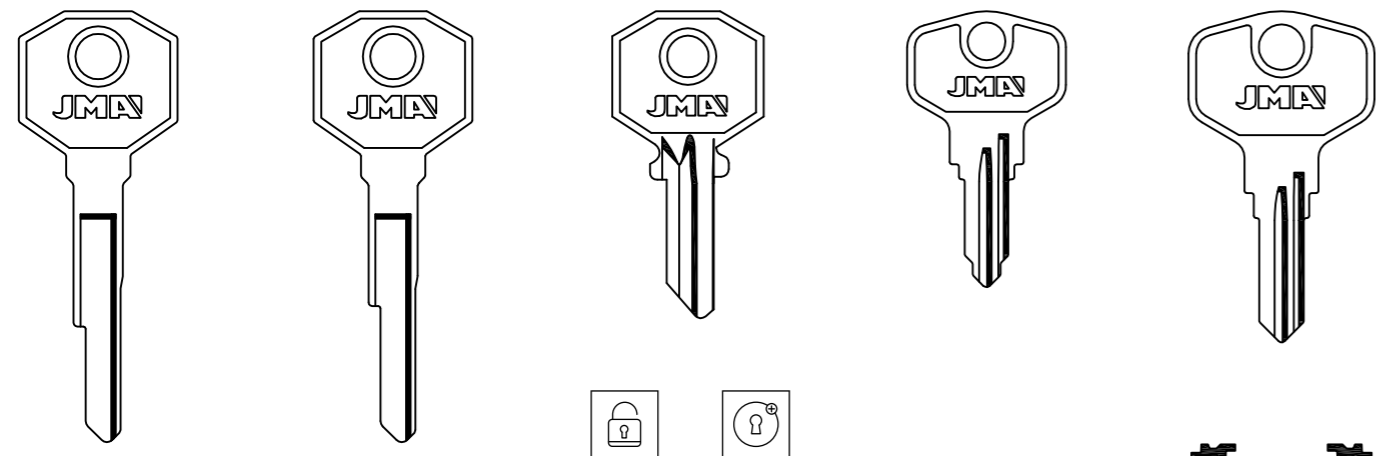

BUR-6 BUR-7 BUR-8D BUR-9 BUR-9D BUR-38 BUR-10 BUR-10D
 1/91/9... 0 AL 6
 FOR: ATL®-BURGWACHTER®-BUVA®-HEWY® FOR: DURABLE®-HOPPE®-RITTAL®-WSM® FOR: CIBOX®-HOPPE®-KIND®-ROTO®

FOR: BURG®

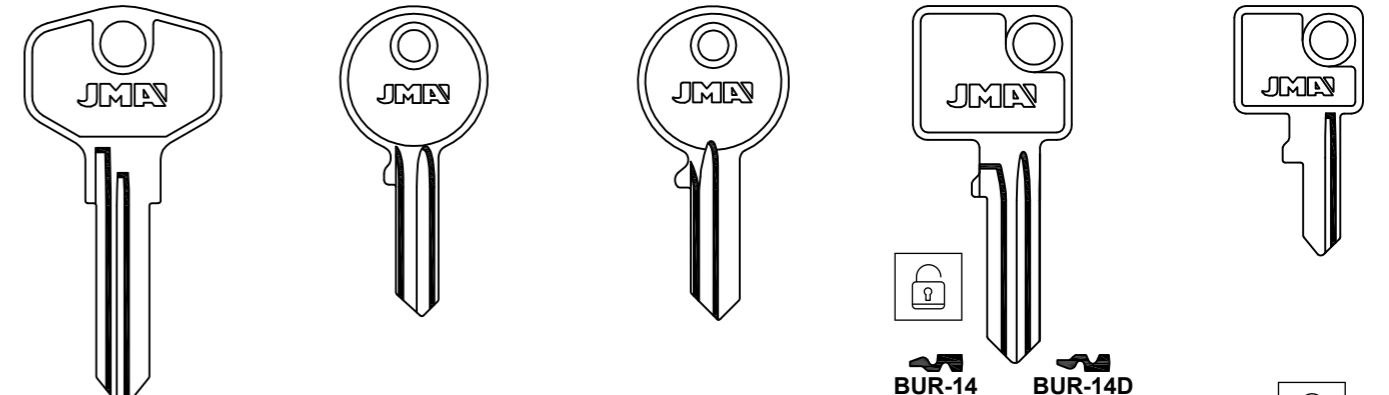

BUR-11D BUR-23D BUR-12 BUR-13D BUR-14 BUR-14D 222 C40 BUR-19D BUR-37D BUR-15
 FOR: ANKE®-BURGWACHTER® FOR: DESAL® FOR: ITEM®-RITTAL® FOR: BURG WACHTER®

FOR: BURG®

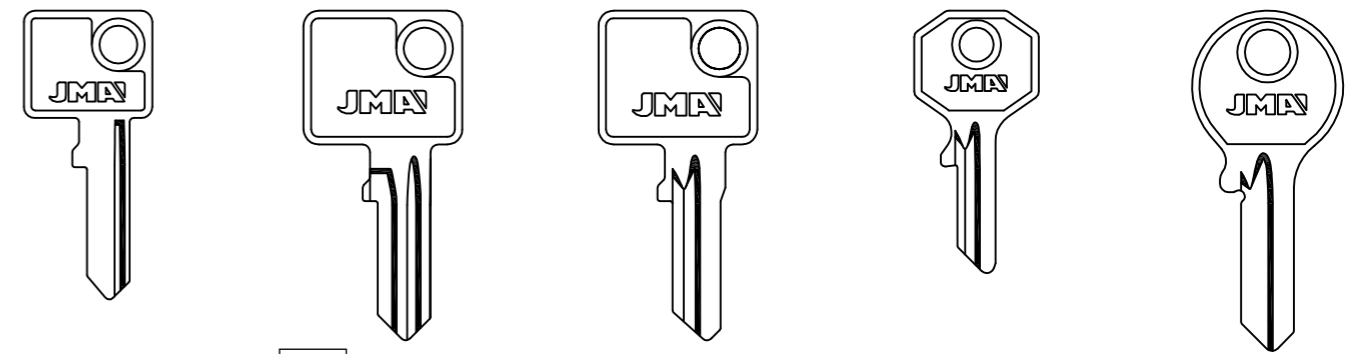

BUR-16 BUR-17 BUR-17D BUR-20D BUR-18D BUR-21D BUR-22D
 222 C30

FOR: BURG®

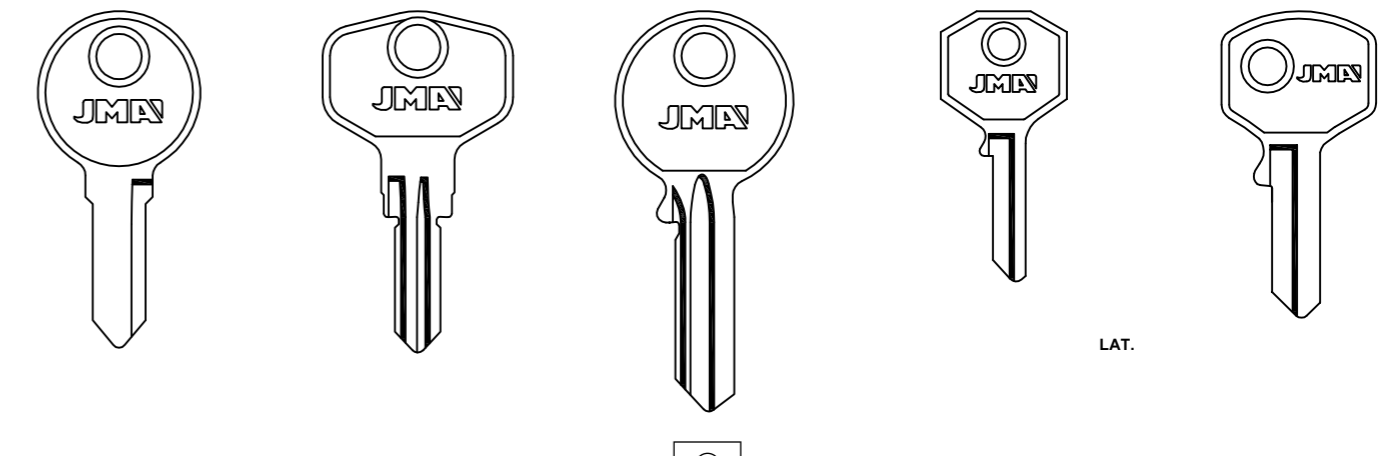

BUR-24 BUR-24D BUR-25D BUR-26D BUR-28 BUR-29 BUR-29D
 LAT.

Concerning the marks and commercial denominations see legal warning.
 Concerniente a las marcas y denominaciones comerciales ver aviso legal.
 Marka eta izendapen komertzialiei dagokienez, ikus lege-oharra.
 Concernant les marques et dénominations commerciales voir la note dans l'index.

JMA® Opening the future

JMA® Opening the future

Beziehen auf die Marke und Handelsname sehen Sie die Notiz im Impressum.
 Relativamente às marcas e denominações comerciais, ver aviso legal.
 Jeśli chodzi o znaki i nazwy handlowe, patrz Informacje prawne.

K01 / 23

FOR: BURG®

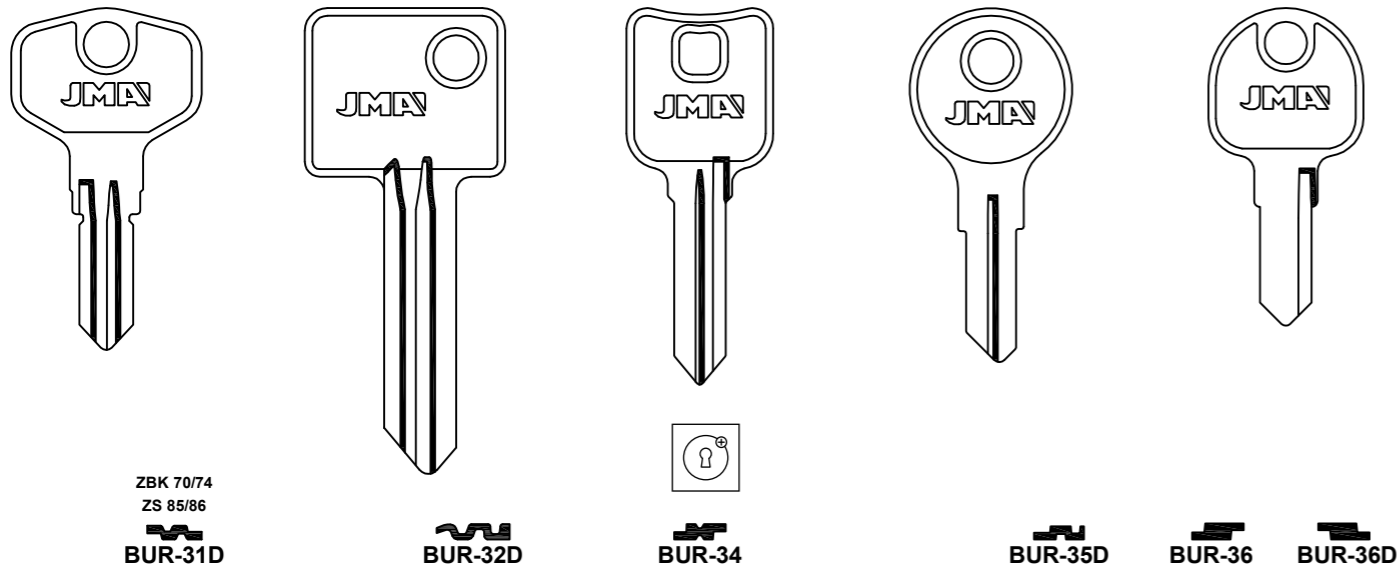

FOR: BURG WACHTER®

FOR: BURG®

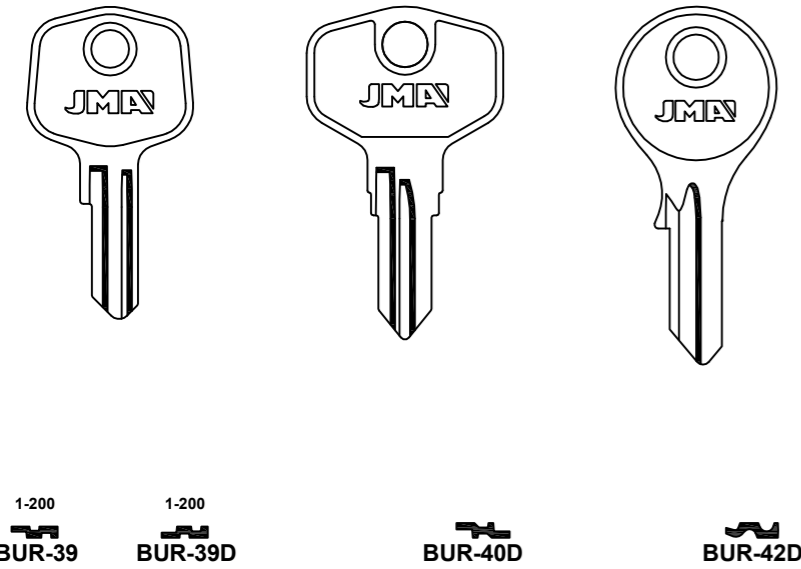

FOR: BURG WACHTER®

FOR: BUS®

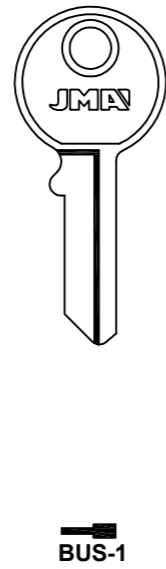

FOR: KROST®

FOR: BUVA®

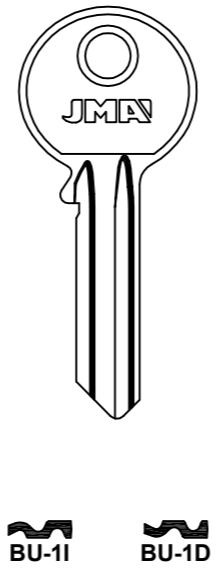

FOR: CAB®

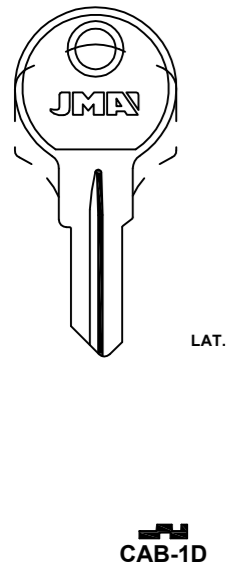

FOR: CAM LOCK®

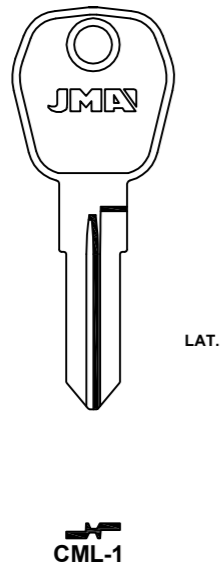

FOR: CANADA POST®

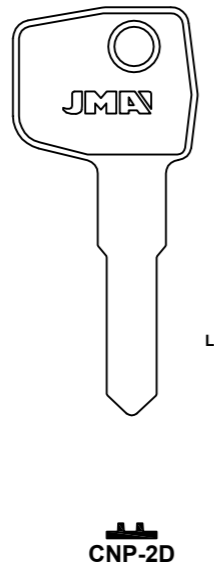

FOR: CARL F®

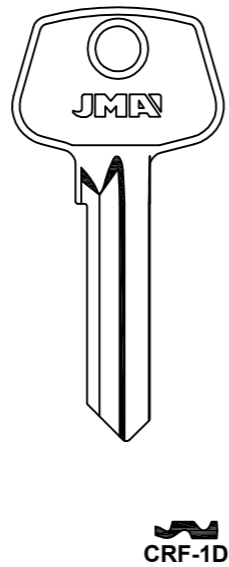

FOR: CARTERO®

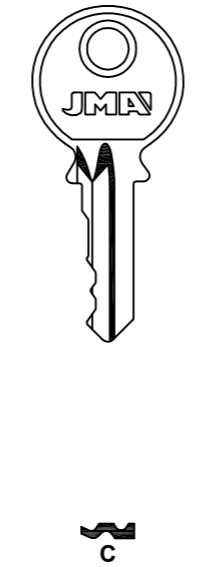

FOR: ABSA®

FOR: CARTERO®

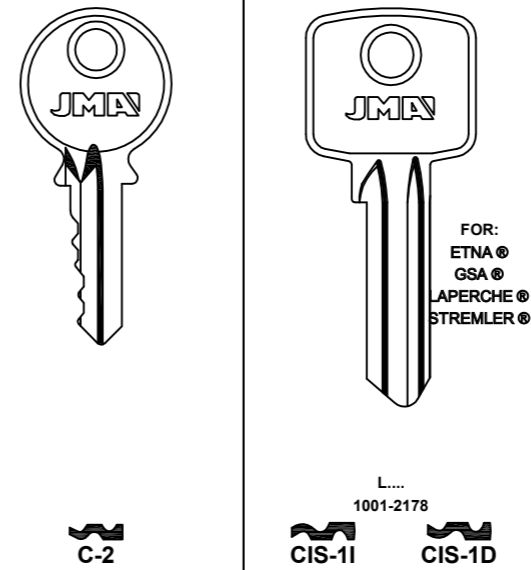

FOR: AGA®-FAC®-STS®

FOR: CAS CISMA®

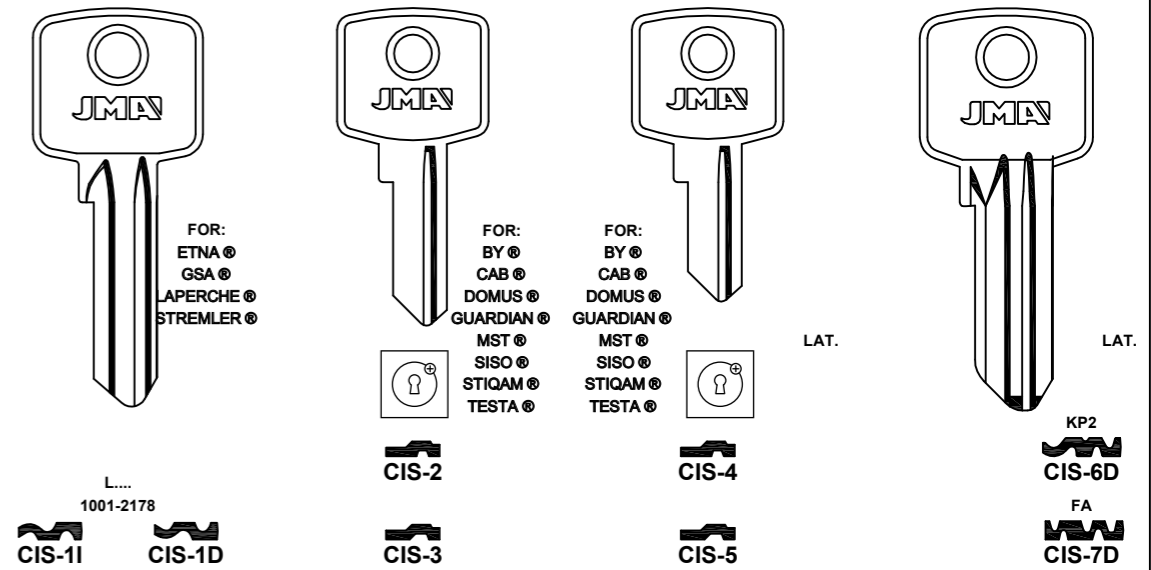

FOR: MERONI®-SOBINCO®

FOR: CASH BOX®

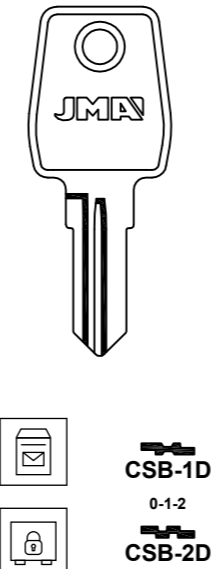

FOR: ARREGUI®-FAC®-JOMA®

FOR: CAVERS®

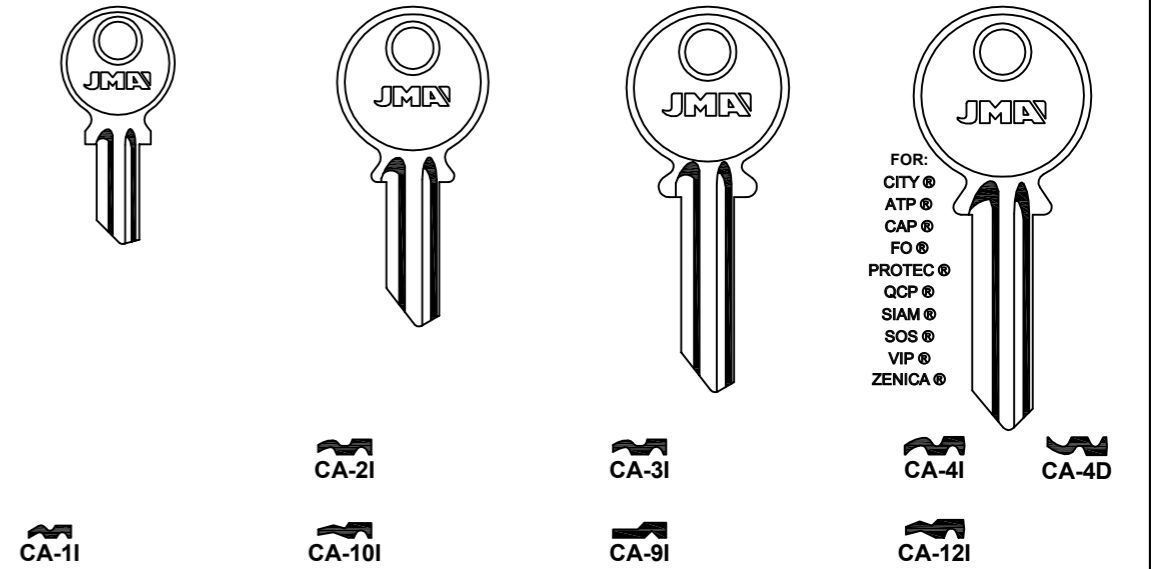

FOR: CITY®

FOR: CITY®-ZENICA®

FOR: CITY®-KVR®

FOR: CAVERS®

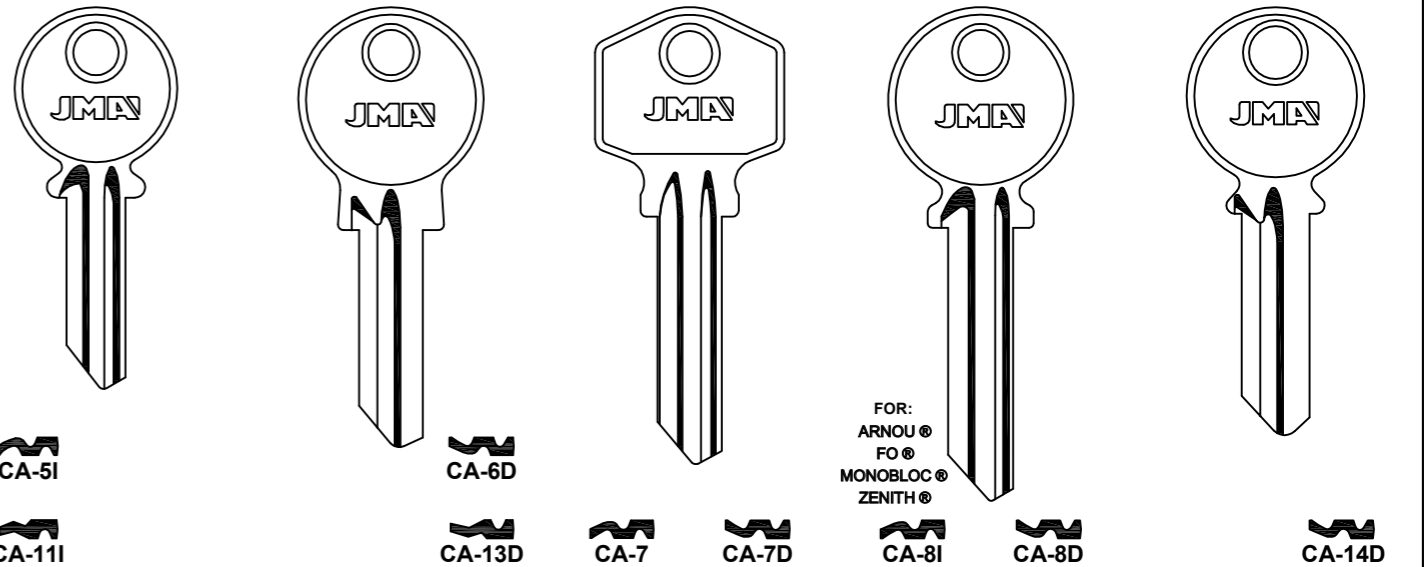

FOR: ZENITH®-ZENICA®

FOR: ZENITH®-ZENICA®

FOR: FO®-ZENITH®

FOR: ZENI®

Concerning the marks and commercial denominations see legal warning.
 Concerniente a las marcas y denominaciones comerciales ver aviso legal.
 Marka eta izendapen komertzialiei dagokienez, ikus lege-oharra.
 Concernant les marques et denominations commerciales voir la note dans l'index.

JMA Opening the future

JMA Opening the future

Beziehen auf die marke und handelsname sehen sie die notiz im Impressum.
 Relativamente às marcas e denominações comerciais, ver aviso legal.
 Jeśli chodzi o znaki i nazwy handlowe, patrz Informacje prawne.

K01 / 25

FOR: CAVERS®

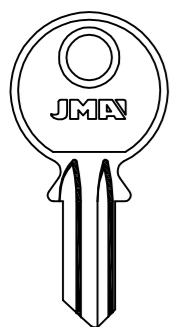

FOR: CITY®

CA-151

FOR: CAYS®

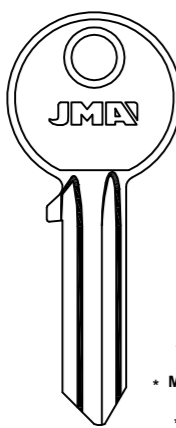

• ALU.
• MTIC.(Y)
• FSH.
• WColor

CAY-1

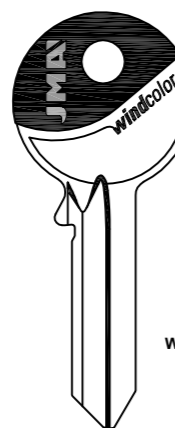

WColor

• CAY-1D

FOR: ILARGI®-SIB®

FOR: CEMA®

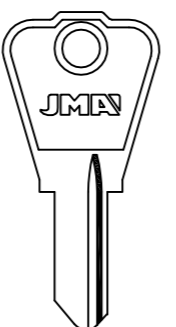

• LAT.

CMA-1

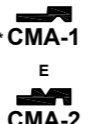

E

CMA-2

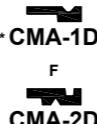

F

CMA-1D

CMA-2D

FOR: ELFIN®-LAMPA®

FOR: CENTURY®

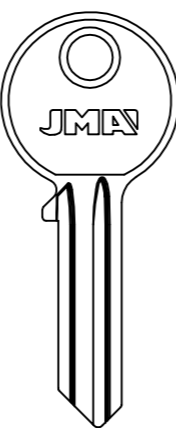

CENT-11



CENT-1D

FOR: ALLGOOD®

FOR: CES®

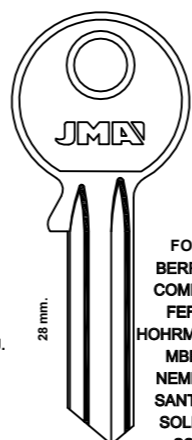

ALU. 28 mm.

FOR: BERRY®
COMBA®
FEFI®
HOHRMANN®
MBB®
NEMEF®
SANTIS®
SOLID®
SS®
STUV®
TRITON®

CE-5



CE-5D



CE-92



CE-92D



CE-93D



FOR: SOLID®

CE-61



CE-6D



CE-71

• MTIC.

* CE-7D



CE-8D

FOR: NEMEF®



S

CE-136D/1

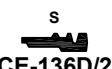

S

CE-136D/2



S

CE-136D/4



S

CE-136D/5

FOR: CENTURY®

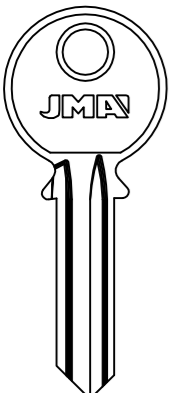

CENT-21



CENT-2D

FOR: ALLGOOD®

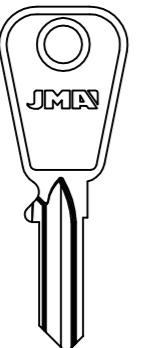

WR
1 AL 4

CENT-3D

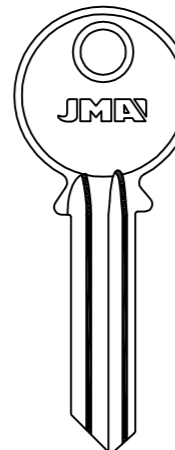

CENT-4

FOR: CERRAMARC®

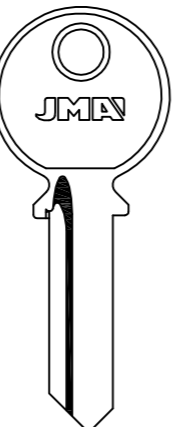

CER-1

FOR: CES®

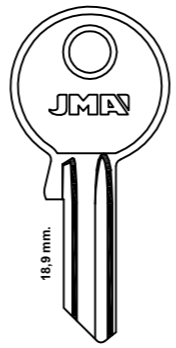

18,9 mm.

CE-11



CE-1D

FOR: STUV®

FOR: CES®

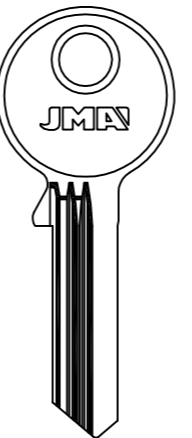

X23

CE-9D



X24

CE-10D



X25

CE-11D



X26

CE-12D



X27

CE-13D



X28

CE-14D



X29

CE-15D



X30

CE-16D



X31

CE-17D



X32

CE-18D



X33

CE-19D



X34

CE-20D



X35

CE-21D



X36

CE-22D



X37

CE-23D



X38

CE-24D



X39

CE-25D



X40

CE-26D



X41

CE-27D



X42

CE-28D



W23

CE-29D



W24

CE-30D



W25

CE-31D



W26

CE-32D



W27

CE-33D



W28

CE-34D



W29

CE-35D



W30

CE-36D



W31

CE-37D



W32

CE-38D



W33

CE-39D



W34

CE-40D



W35

CE-41D



W36

CE-42D



W37

CE-43D



W38

CE-44D



W39

CE-45D



W40

CE-46D



W41

CE-47D



W42

CE-48D



CE-49



CE-49D

FOR: SOLID®

FOR: CES®

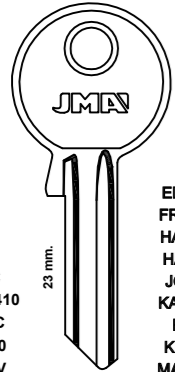

1C
401-410
10C
1-10
HLV
911-950
FOR:
BODA®
ELZETT®
FRECOV®
KNAPP®

23 mm.

CE-21



CE-2D



FOR:
ELZETT®
FRECOV®
HAFELE®
HANNO®
JOSTA®
KARDEX®
KIND®
KNAPP®
MAUSER®
NEMEF®

CE-108



CE-101D



CE-100D



CE-99D

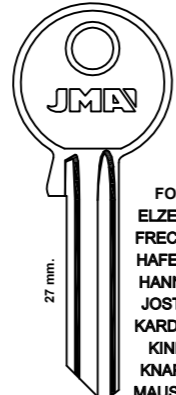

27 mm.

CE-31



CE-3D



FOR:
BODA®
ELZETT®
FRECOV®
KNAPP®
NEMEF®
OJMAR®
VOKO®
WASO®
WECO®

CE-3D



CE-4D

FOR: CASMA®-SPEEDAL®

FOR: CES®

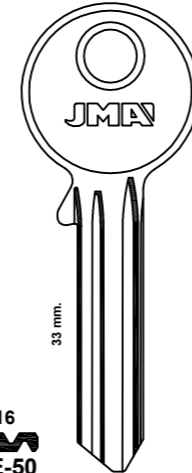

16

CE-50



1Z...1-100000

CE-51



CE-51D

• LAT.



26

• CE-55



27

• CE-56



28

• CE-57



15

• CE-77



17

• CE-78



18

• CE-79



25

• CE-80



35

• CE-81



36

• CE-82



37

• CE-83



38

• CE-84



45

• CE-85



46

• CE-86



47

• CE-87



48

• CE-88



CE-91



CE-52



CE-53D

FOR: HAFELE®

Concerning the marks and commercial denominations see legal warning.
Concieniente a las marcas y denominaciones comerciales ver aviso legal.
Marka eta izendapen komertzialiei dagokienez, ikus lege-oharra.
Concernant les marques et denominations commerciales voir la note dans l'index.

FOR: CES®

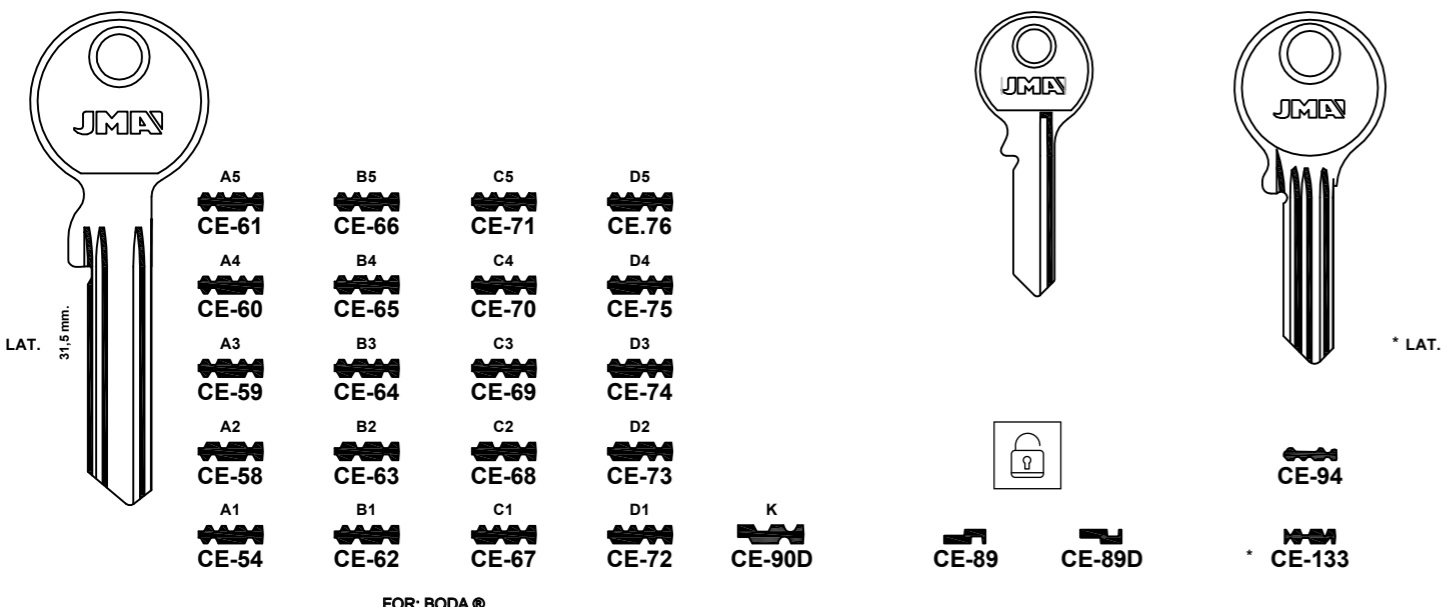

FOR: CES®

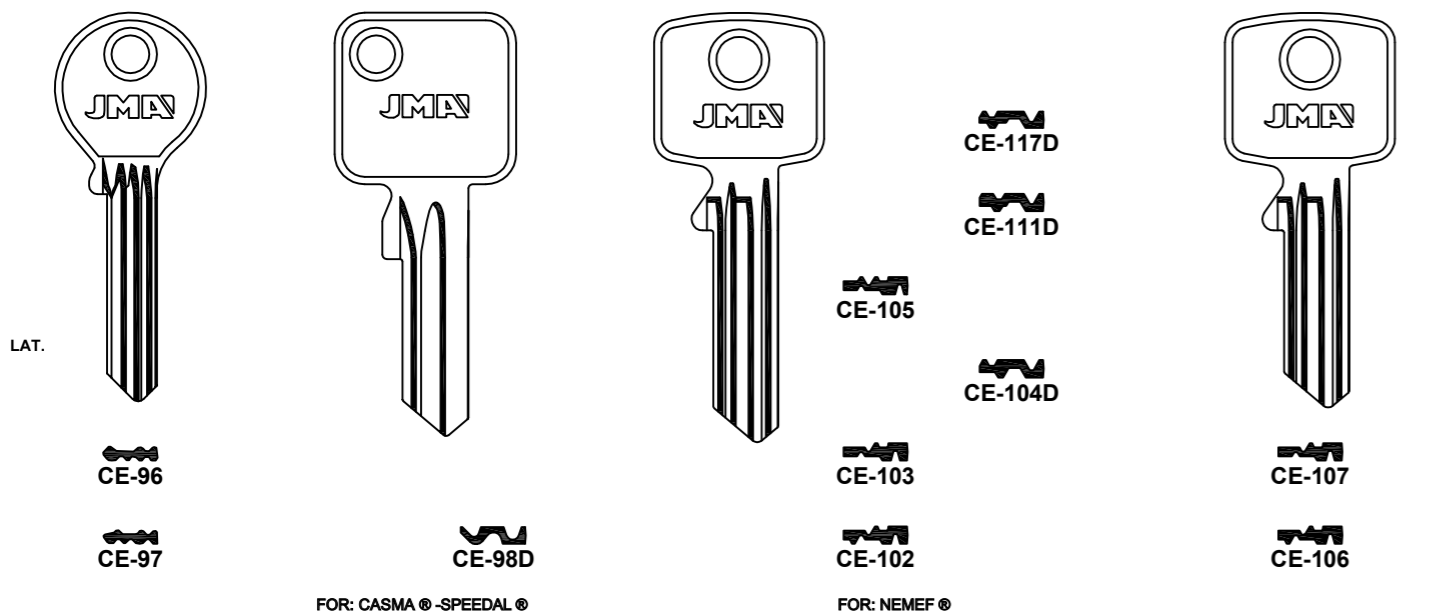

FOR: CES®

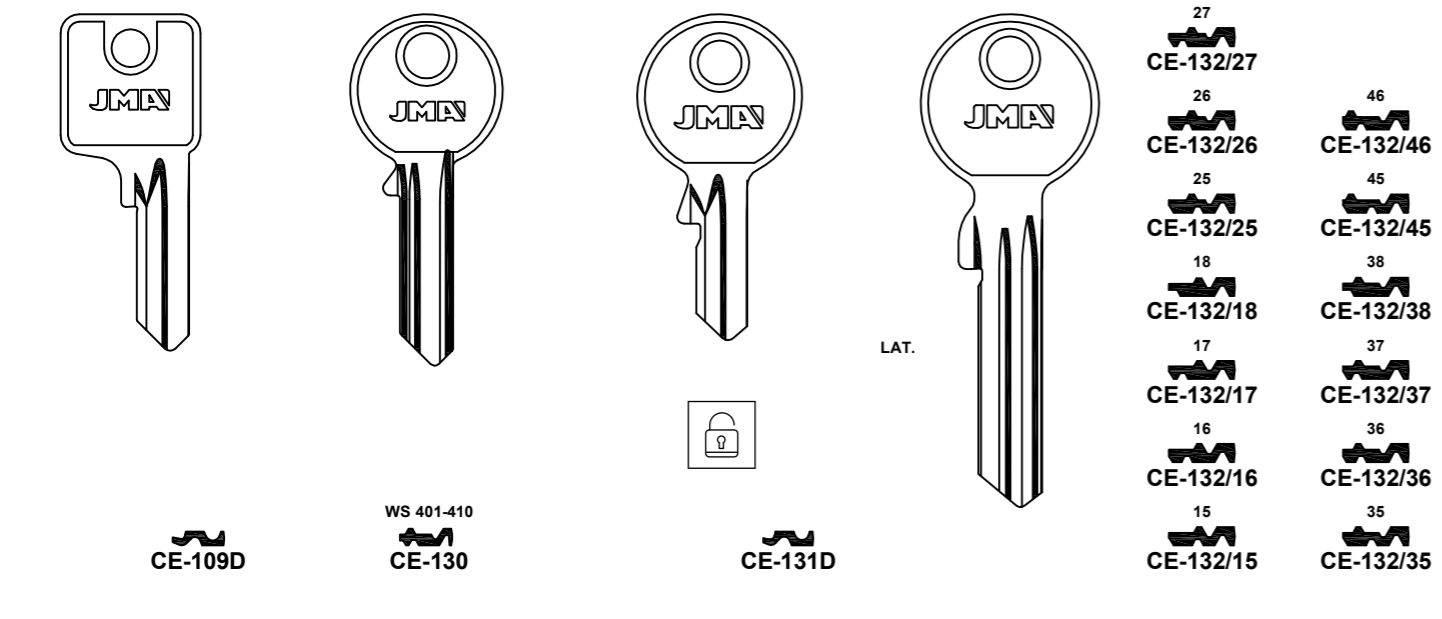

FOR: CES®

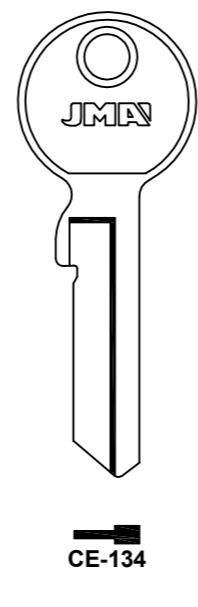

FOR: CHAVO®

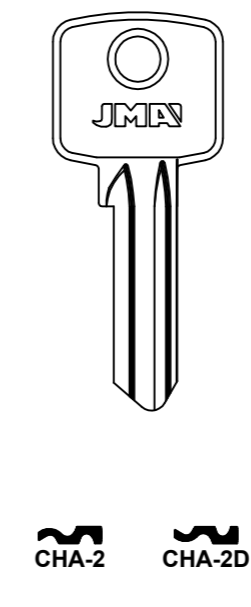

FOR: CHELIABINSK®

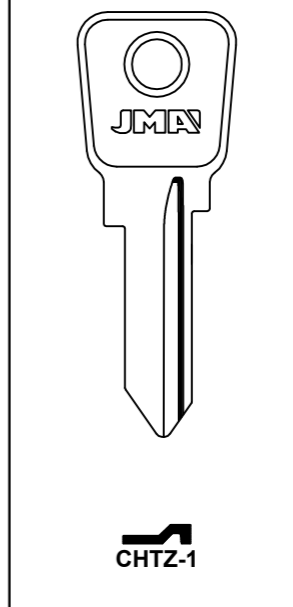

FOR: CHEYLOCK®

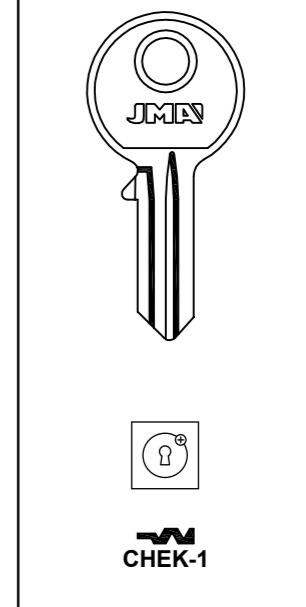

FOR: CHICAGO®

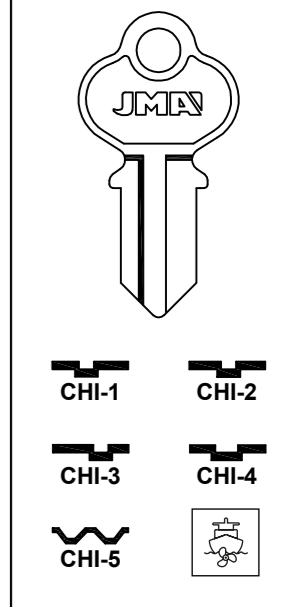

FOR: CHICAGO®

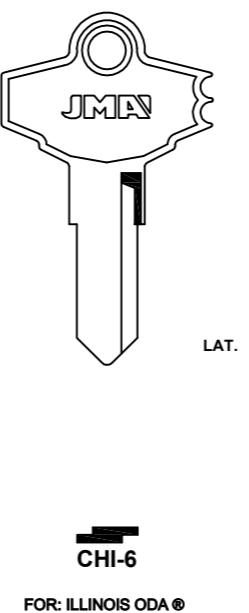

FOR: CHUBB®

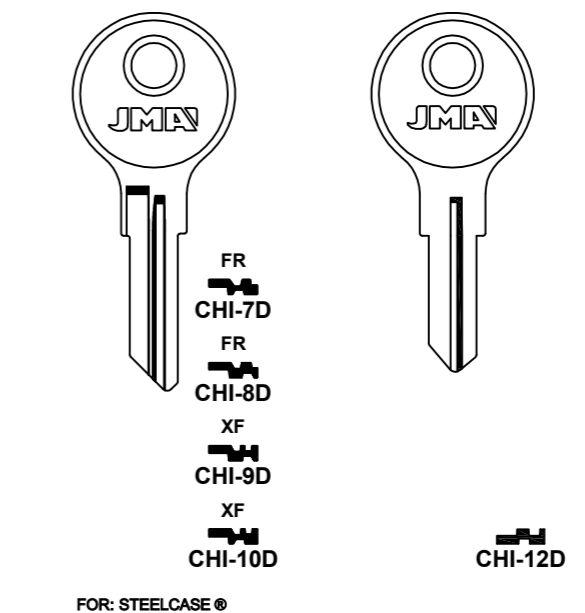

FOR: CHUBB®

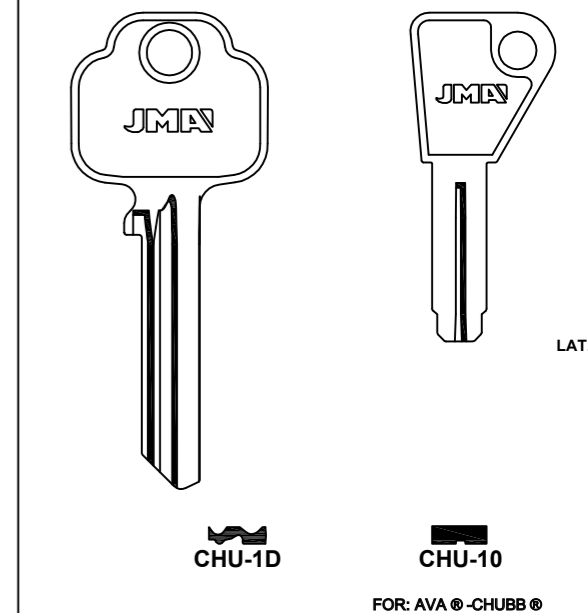

FOR: CIEF®

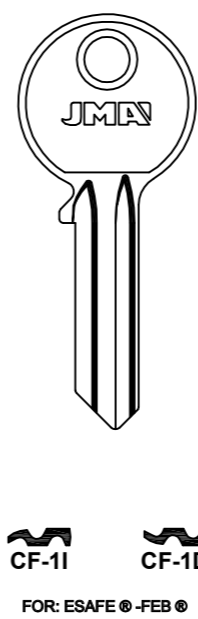

FOR: CIFIAL®

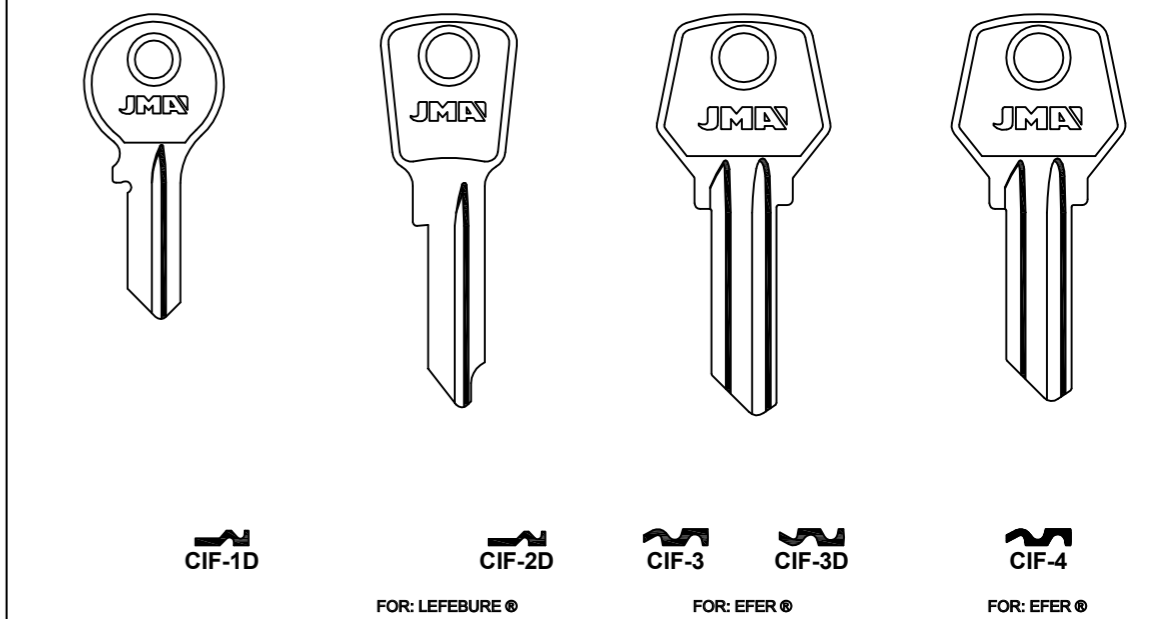

Concerning the marks and commercial denominations see legal warning.
 Concerniente a las marcas y denominaciones comerciales ver aviso legal.
 Marka eta izendapen komertzialiei dagokienez, ikus lege-oharra.
 Concernant les marques et dénominations commerciales voir la note dans l'index.

JMA Opening the future

JMA Opening the future

Beziehen auf die marke und handelsname sehen sie die notiz im Impressum.
 Relativamente às marcas e denominações comerciais, ver aviso legal.
 Jeśli chodzi o znaki i nazwy handlowe, patrz Informacje prawne.

FOR: CILA-GENTILI®

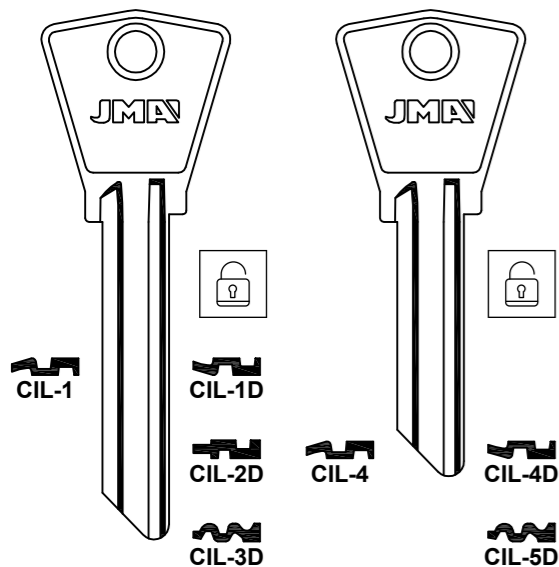

FOR: CINA®

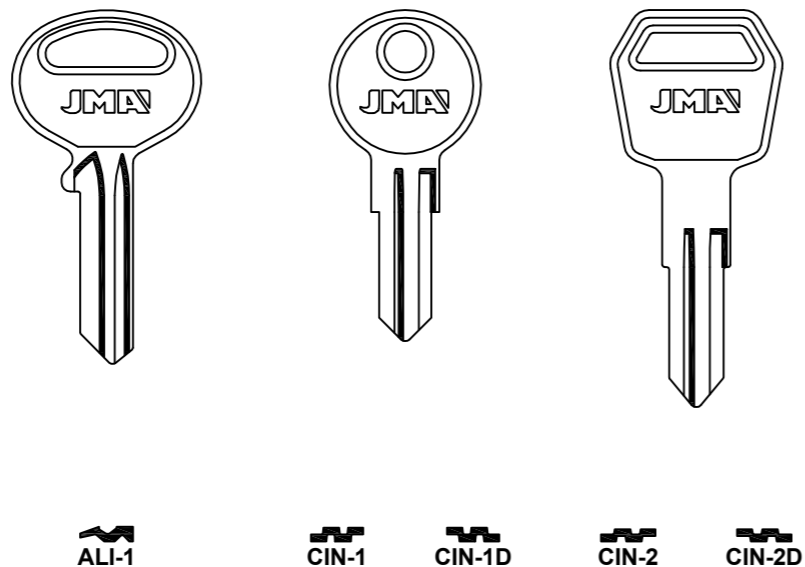

FOR: CISA®

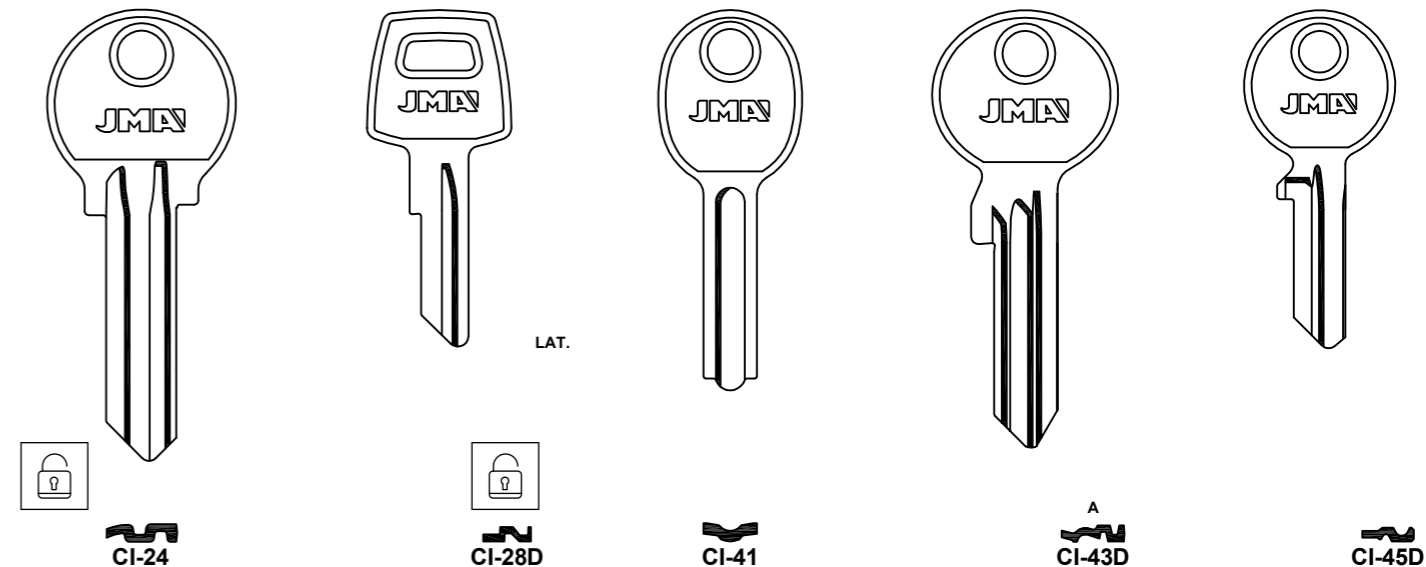

FOR: CISA®

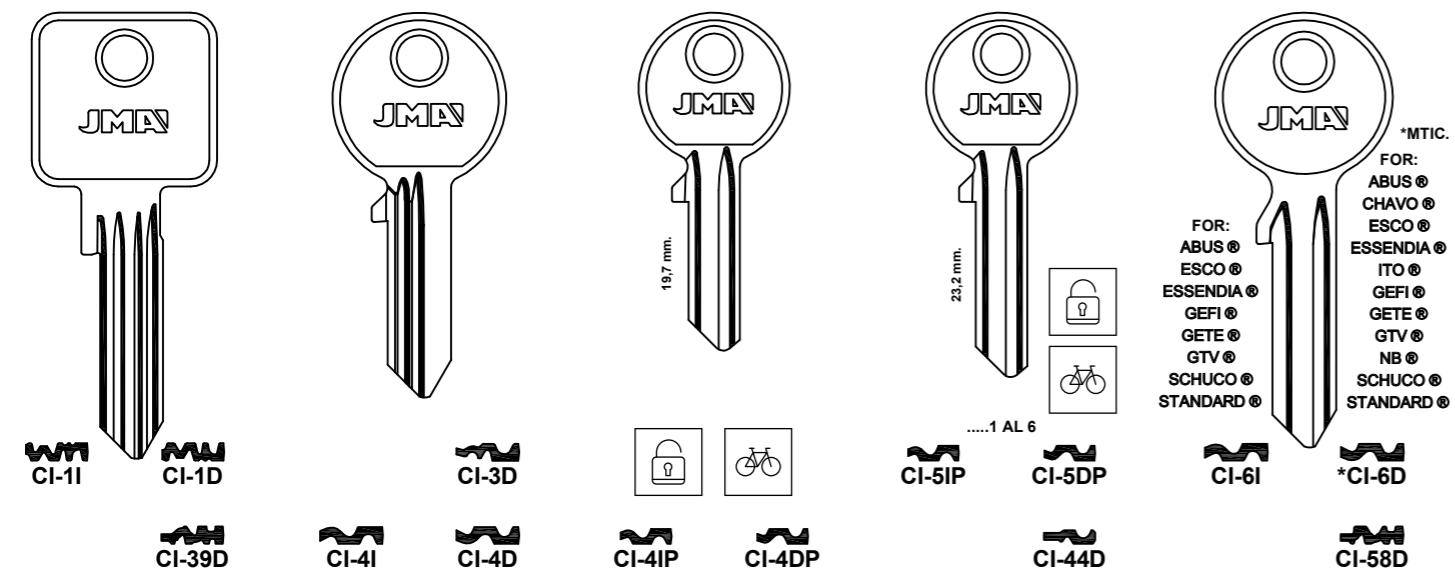

FOR: CISA®

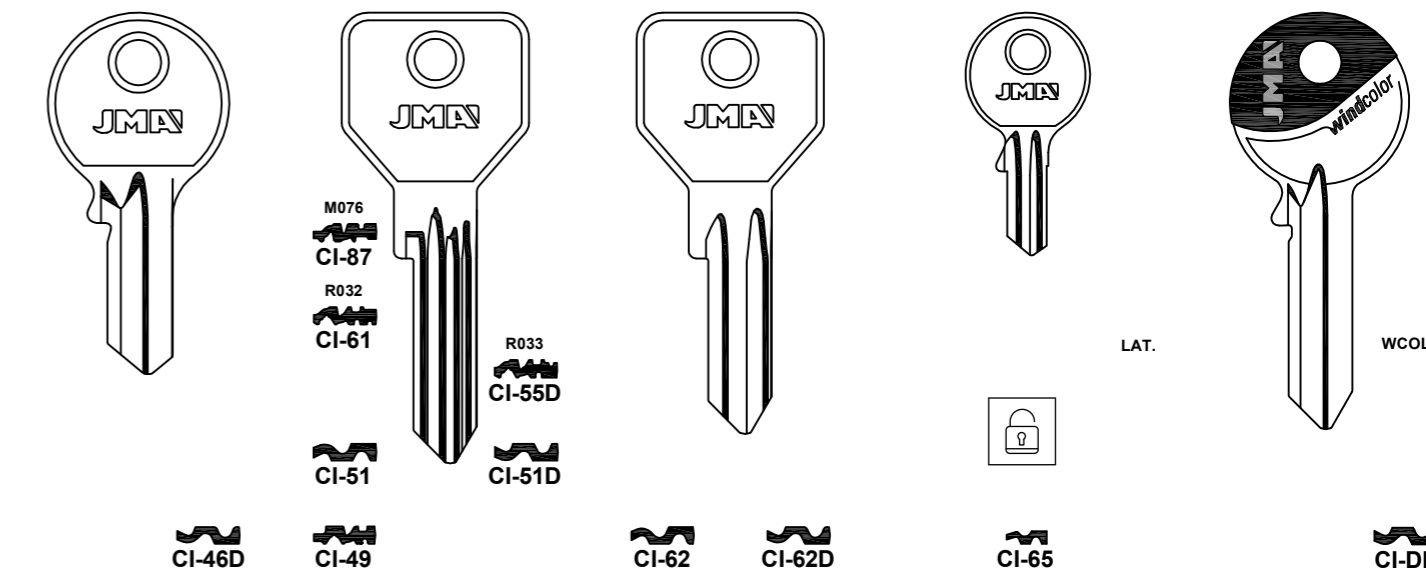

FOR: CISA®

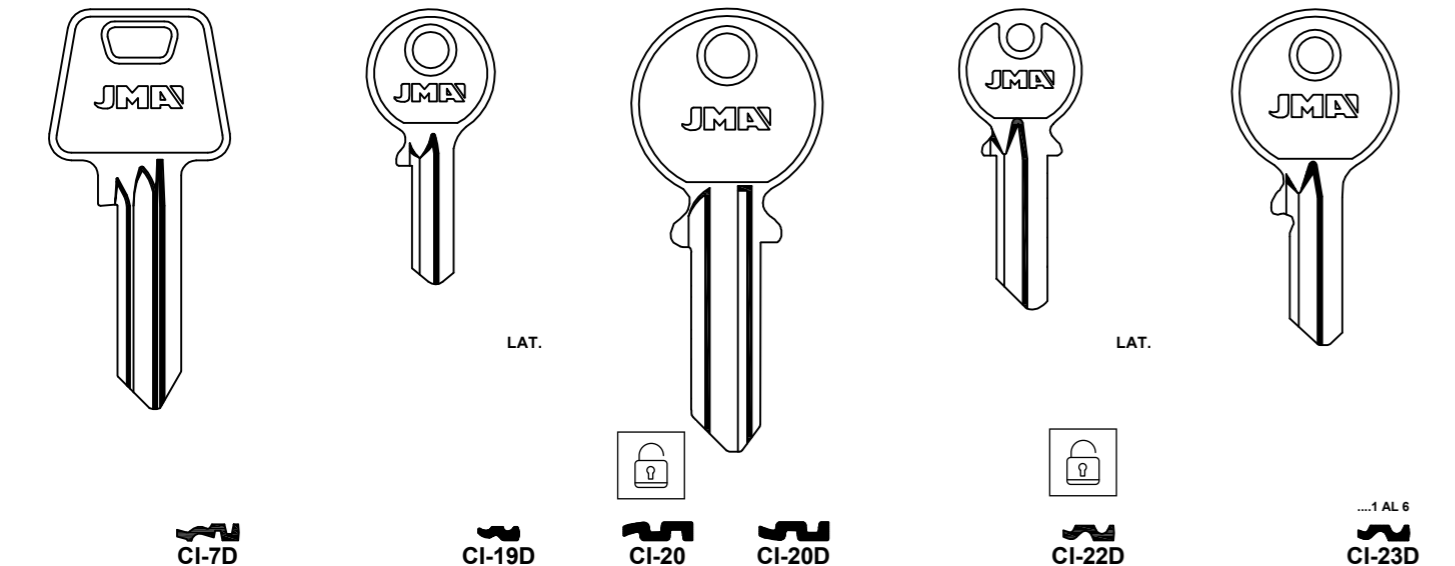

FOR: CISA®

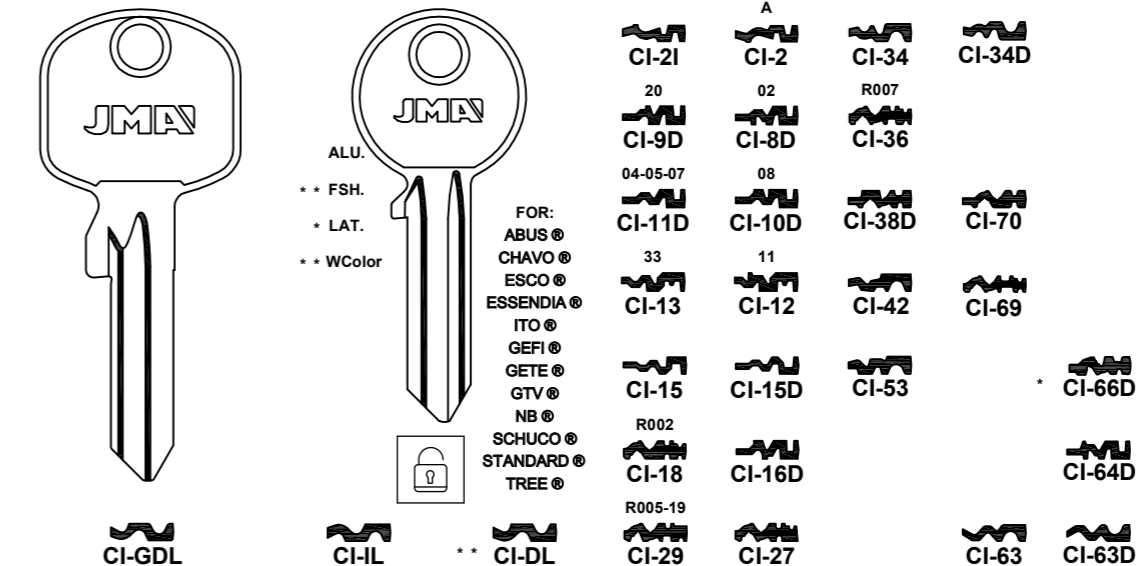

FOR: CLARK FORK L.®

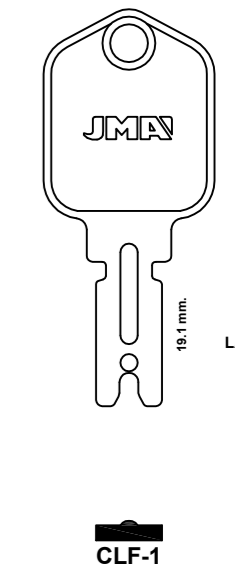

Concerning the marks and commercial denominations see legal warning.
 Concerniente a las marcas y denominaciones comerciales ver aviso legal.
 Marka eta izendapen komertzialiei dagokienez, ikus lege-oharra.
 Concernant les marques et denominations commerciales voir la note dans l'index.

JMA Opening the future

JMA Opening the future

Beziehen auf die marke und handelsname sehen sie die notiz im Impressum.
 Relativamente às marcas e denominações comerciais, ver aviso legal.
 Ješli chodzí o znaki i nazwy handlowe, patrz Informacje prawne.

FOR: CLASSIC® **FOR: CLAUSOR®** **FOR: CLEMSA®**

ALU. PLAS. PLAS.

CLS-1D CL-11 MG-6I MG-6S MG-6D MG-9

FOR: BRABANTIA®

FOR: CORBIN®

28 mm. 30,7 mm.

COR-7 COR-8 COR-9 COR-10 COR-61 COR-11 COR-11D COR-12 COR-13 COR-13D COR-72

1 AL 9
0 AL 8
2 AL 8

FOR: MASTER® **FOR: EUROPARTNER® -FUCHS®**

FOR: COHIKO® **FOR: COM®**

COH-1 COH-2 COH-2D COH-3 COH-4 COM-1D

FOR: SONICO®

28 mm.

FOR: CORBIN®

027 * COR-64 029 * COR-65 038 * COR-66 * COR-67 * COR-68 * COR-71

* LAT.

COR-15D COR-73 COR-74 COR-17D COR-20 COR-20D COR-20/25 COR-23D

1 AL 6

FOR: TESIO®

FOR: CORBIN®

FOR: ALUNORM® CRC® -CAMBOA® DOM® ESCO® EURONORM® HEGO® HESTE® ISSERSTEDT® KAWE® LITTO® * COR-48 MERMIER® MUKRA® NEMEF® NOVOFERM® COR-49 BWS STREMLER® SUL® THONE® VERSCO® ZECE® CORNI®

COR-18D COR-19D COR-21D COR-22D COR-36D COR-1GD COR-1D COR-21 COR-2D COR-3 COR-3D COR-79 COR-76D COR-1GD COR-1D COR-16D

FOR: ESCO® -KAWE® -LITTO® -NEMEF®

* LAT. ** MTIC. ** ALU. ** WColor

FOR: CORBIN®

23 mm. 21 mm.

...1 AL 7 ...2 AL 7

COR-24 COR-24D COR-25I COR-25 COR-26 COR-27D COR-28

FOR: CHANGE-O-MATIC® -BOBRICK® FOR: SKILMANN® FOR: ESCO® -EURONORM® -KAWE® -MUKRA®

Concerning the marks and commercial denominations see legal warning.
 Concerniente a las marcas y denominaciones comerciales ver aviso legal.
 Marka eta izendapen komertzialiei dagokienez, ikus lege-oharra.
 Concernant les marques et denominations commerciales voir la note dans l'index.

Beziehen auf die marke und handelsname sehen sie die notiz im Impressum.
 Relativamente às marcas e denominações comerciais, ver aviso legal.
 Jeśli chodzi o znaki i nazwy handlowe, patrz Informacje prawne.

FOR: CORBIN®

COR-29D COR-30 COR-31 COR-32 COR-33 COR-34

FOR: CCL®

FOR: CORBIN®

ACE. LAT. COR-35 COR-40 COR-50/60 COR-62 COR-70 COR-70D

FOR: LANE® FOR: OAL® FOR: MERMIER®-OAL®

FOR: CORBIN®

COR-78 COR-114 COR-115D COR-153 COR-223

FOR: BLACK & DECKER®

FOR: CORBIN®

COR-231 COR-232D

FOR: BWS®

FOR: CORONA®

CO-1D CO-M

FOR: BAB®-BURG®-DOCO®-GEBRO®-IKON® FOR: IKON®

FOR: COTICO®

COT-1D

FOR: CRAZY LOCKS®

CLK-1

FOR: CUBELLS®

CUB-1

FOR: CVL®

CVL-11 CVL-1D CVL-21 CVL-2D CVL-31 CVL-3D

FOR: SERRALLER® FOR: UCER®

FOR: CVL®

CVL-4 CVL-5I CVL-5D

FOR: AUMON®-CAYS®-CAZORLA®-EURO® FOR: AUMON®-CAYS®-CAZORLA®-EURO®
FERMOD-JJ-PP-QCM FOR: FERMOD®-JJ®-PP®-QCM®

FOR: DAD®

DAD-11 DAD-1D DAD-21 DAD-2D DAD-3D DAD-4D DAD-5D DAD-6D

FOR: DECAYEUX® FOR: ARFE®-DECAYEUX®

FOR: DAF®		FOR: DEFA®		FOR: DEKABA®	
DAF-1	DAF-1D	DEF-1D	DEF-1D	DEK-2	DEK-6D
				DEK-7D	DEK-14D
				FOR: MAUER®	FOR: MAUER®
					DEK-9D

FOR: DEKABA®		FOR: DELAPORTE®		FOR: DELMET®	
DEK-10	DEK-13	2501-2550	DLP-1	DLM-1D	DLM-1D
	FOR: MAUER®		DLP-2		
		FOR: DIRAK®-EMKA®			FOR: M&D®

FOR: DEXTER®		FOR: DIAMOND®			
DX-5	DX-5D	DIA-1	DIA-2	DIA-3	DIA-3
0 AL 7 T 0 AL 9 0 AL 9	0 AL 7 0 AL 9				

FOR: DIEBOLD®	FOR: DIMITROVGRAD®	FOR: DINBOX®	FOR: DOM®	
DIE-1	DM-1	DBX-1D	DOM-11	DOM-1D
			18 mm.	18 mm.
			* ALU.	* FSH.
			2D 001-222	2D 001-222
			5A 0001-2600	5A 0001-2600
			9A 0001-5200	9A 0001-5200
			1D 601-654	1D 601-654
				DOM-1D.P

FOR: DOM®				
DOM-21D	DOM-2D	DOM-44D	DOM-45	DOM-46D
FOR: MOREAUX®-STUV®-CORBIN®	FOR: PLURA®	FOR: LISTA®	FOR: LISTA®	FOR: LISTA®
	DOM-75	DOM-3I	DOM-3D	DOM-3D
		DOM-78D	DOM-4	DOM-4D
		DOM-79D	DOM-8D	DOM-8D
		DOM-80	DOM-5D	DOM-5D
		DOM-80D	DOM-6I	DOM-6D
			FOR: BARRO®-IDEAL®-TM®	

FOR: DOM®				
DOM-71	DOM-7D	DOM-9	DOM-9D	DOM-10D
FOR: HOHRMANN®	FOR: NOBO®	FOR: NOBO®	FOR: NOBO®	FOR: NOBO®

Concerning the marks and commercial denominations see legal warning.
 Concerniente a las marcas y denominaciones comerciales ver aviso legal.
 Marka eta izendapen komertzialiei dagokienez, ikus lege-oharra.
 Concernant les marques et dénominations commerciales voir la note dans l'index.

JMA Opening the future

JMA Opening the future

Beziehen auf die Marke und Handelsname sehen Sie die Notiz im Impressum.
 Relativamente às marcas e denominações comerciais, ver aviso legal.
 Jeśli chodzi o znaki i nazwy handlowe, patrz Informacje prawne.

FOR: DOM®

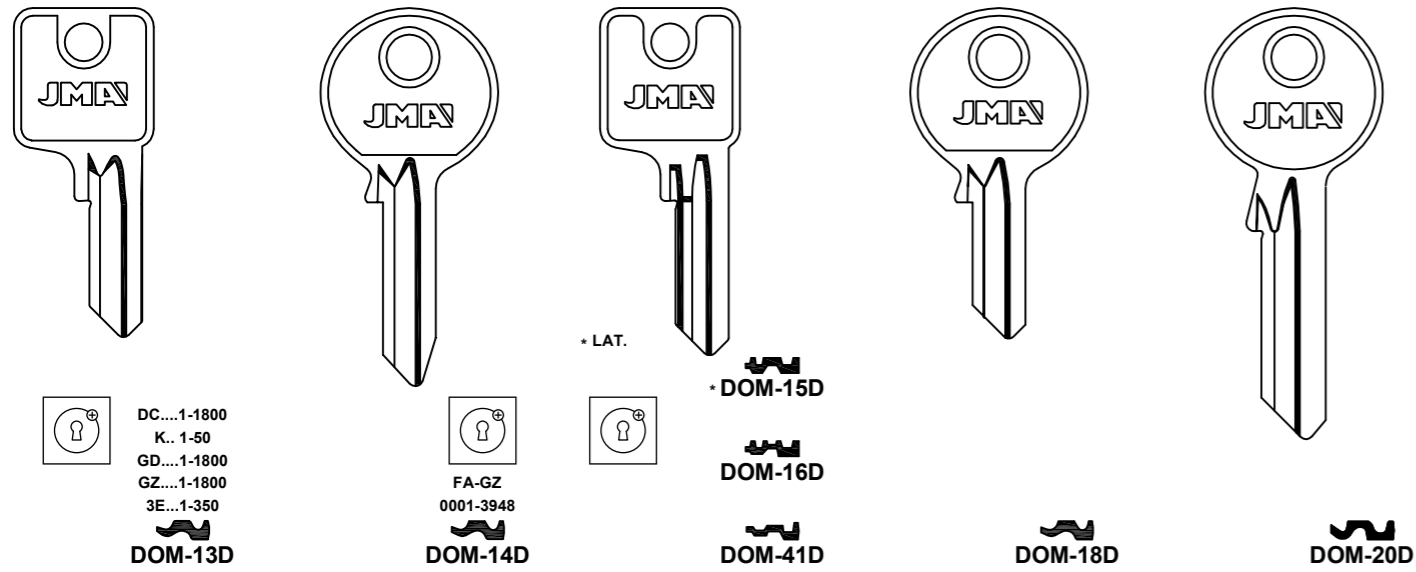

FOR: DOM®

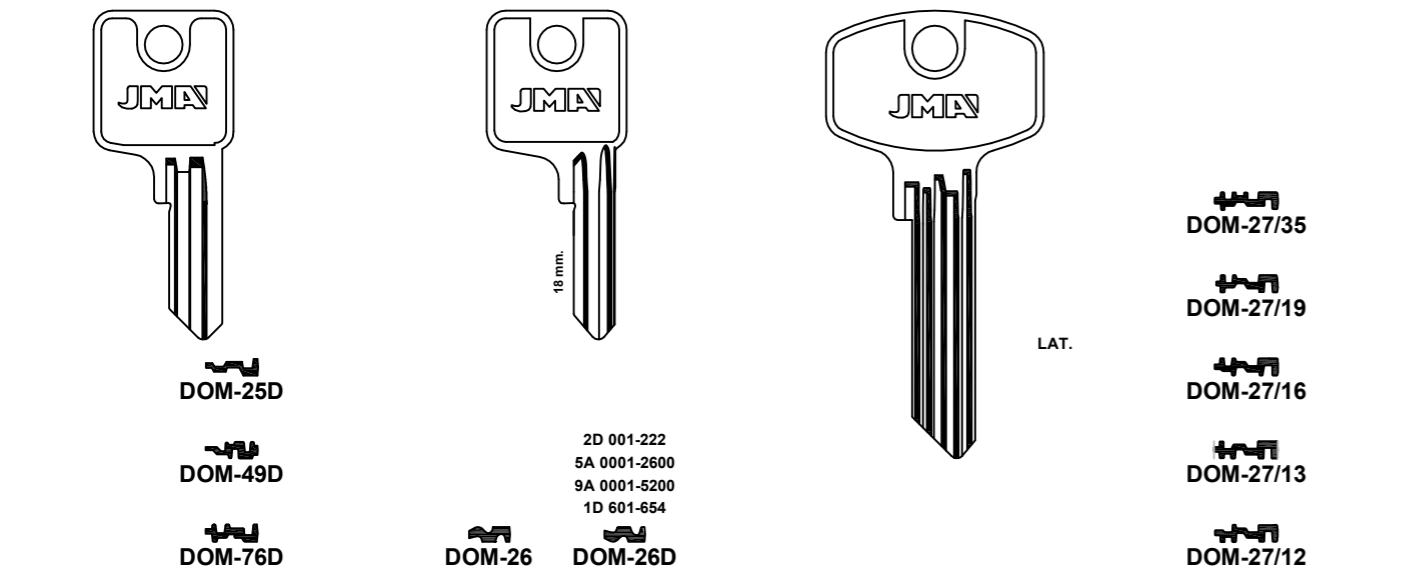

FOR: DOM®



FOR: DOM®

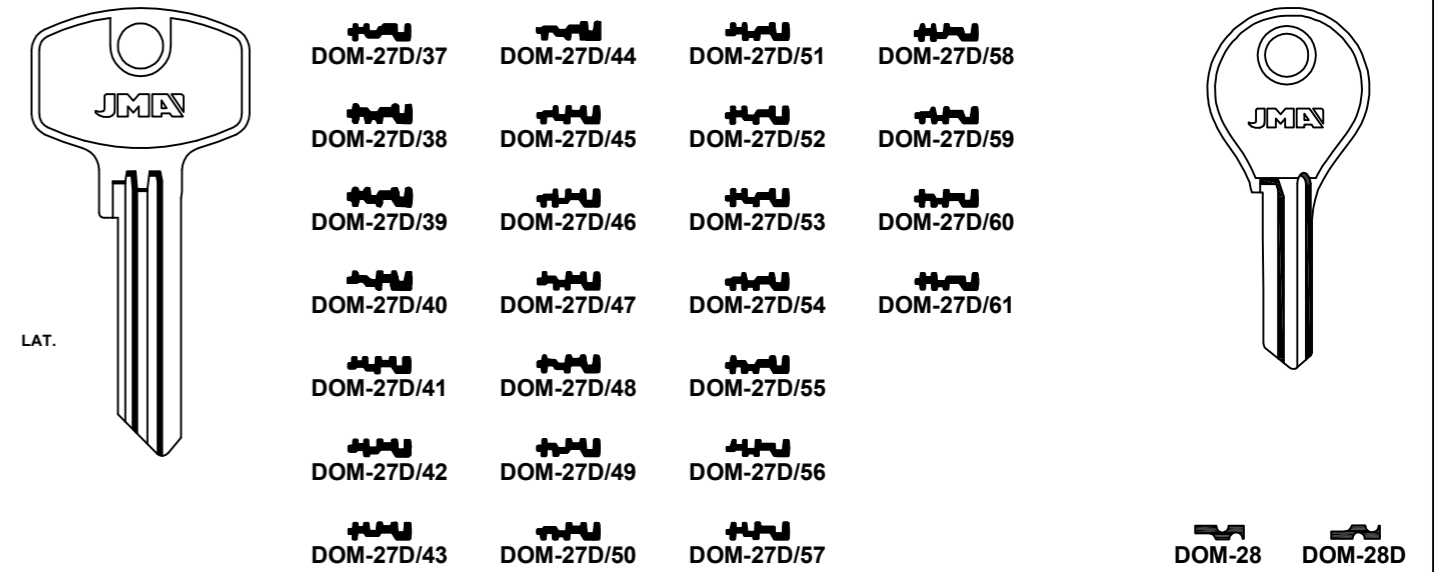

FOR: DOM®

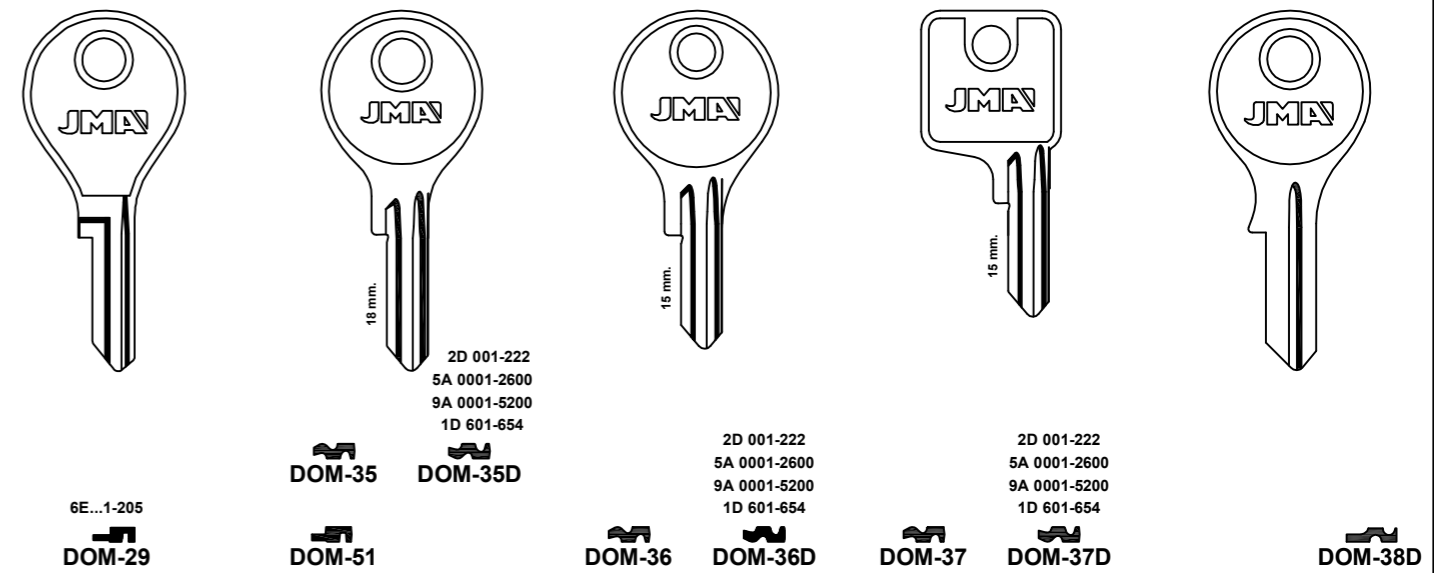

FOR: DOM®

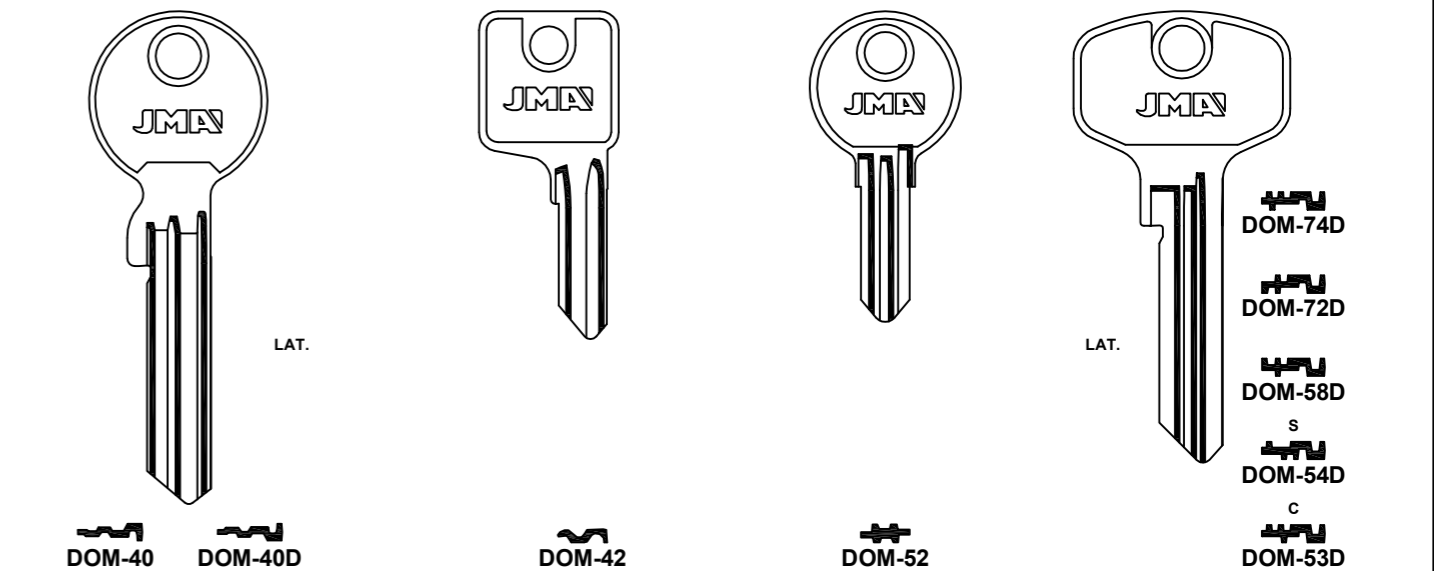

Concerning the marks and commercial denominations see legal warning.
Concerniente a las marcas y denominaciones comerciales ver aviso legal.
Marka eta izendapen komertzialiei dagokienez, ikus lege-oharra.
Concernant les marques et dénominations commerciales voir la note dans l'index.

JMA Opening the future

JMA Opening the future

Beziehen auf die marke und handelsname sehen sie die notiz im Impressum.
Relativamente às marcas e denominações comerciais, ver aviso legal.
Jeśli chodzi o znaki i nazwy handlowe, patrz Informacje prawne.

FOR: DOM®

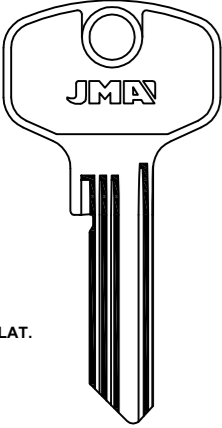

JMA
DOM-73D

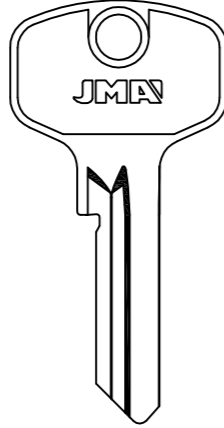

JMA
DOM-71D



DOM-65

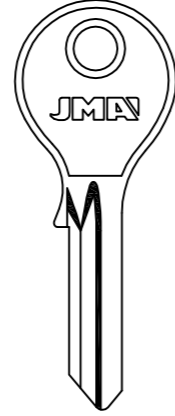

JMA
DOM-67D



DOM-61

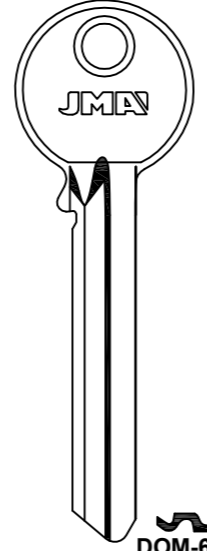

JMA
DOM-60D



DOM-59



DOM-57



DOM-55



DOM-57D



DOM-55D



DOM-62D



DOM-64D



DOM-66D

LAT.

FOR: STUV®

FOR: DOUBLE CIRCLE® FOR: DURALOCK® FOR: EAG® FOR: EAGLE® FOR: ECM®



JMA
DC-4D

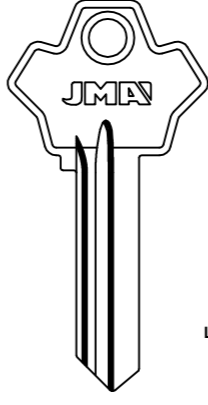

JMA
DUR-1D

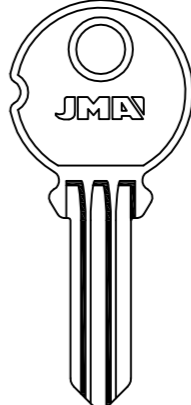

JMA
EG-2



EG-1

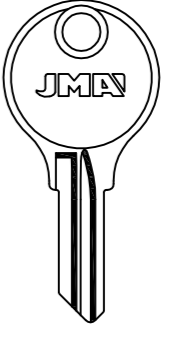

JMA
EAG-2D

EZ...
PZ...
1-240



EC-1



EC-1D

LAT.

FOR: DOM® FOR: DOMINION LOCK® FOR: DOMUS®

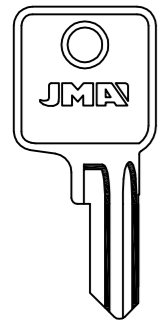

JMA



JMA

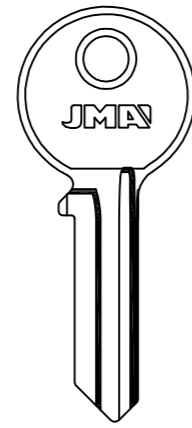

JMA

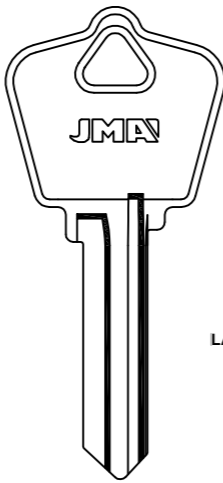

JMA



DOI-1



DOI-4



DO-2I

CL...1-250
GP...1-250
C...1001-1200
C...1301-1500



DOM-68



DOM-77D

LAT.

FOR: GEWIRU® FOR: PETERBORO®

FOR: EIKO® FOR: ELZETT®

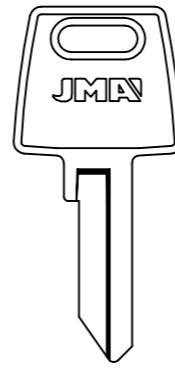

JMA
EI-1D

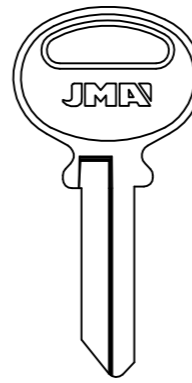

JMA
EI-2D

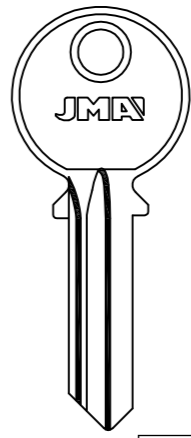

JMA
ELZ-1D



ELZ-2



ELZ-3D



ELZ-4



ELZ-4D



ELZ-5D



ELZ-6D

FOR: CINA® FOR: TIEFENTHAL® -TUTIS®

FOR: DOMUS® FOR: DOUBLE CIRCLE®

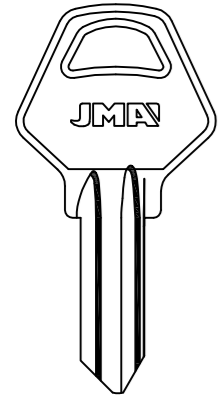

JMA
DO-5

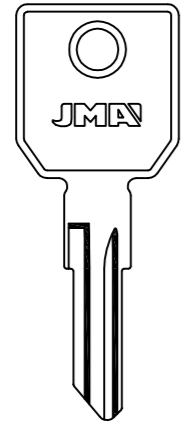

JMA
DO-5D



DO-7

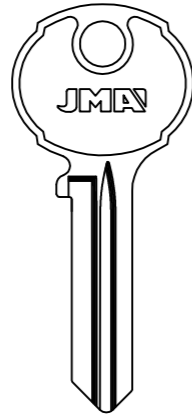

JMA
DC-1D

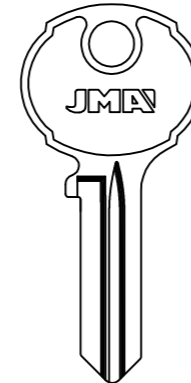

JMA
DC-2D

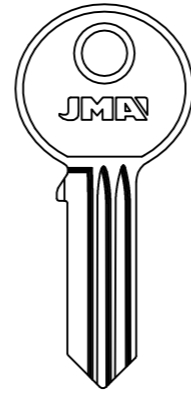

JMA
DC-3

FOR: TRI CIRCLE®

FOR: ELZETT® FOR: EMKA®

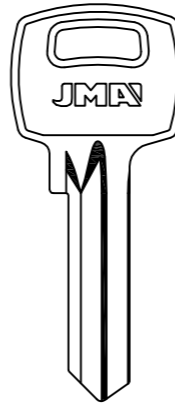

JMA
ELZ-8D

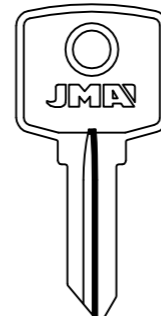

JMA
ELZ-14D



ELZ-9

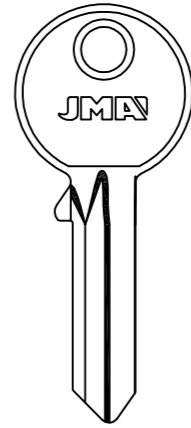

JMA
ELZ-11D



ELZ-12



ELZ-12D

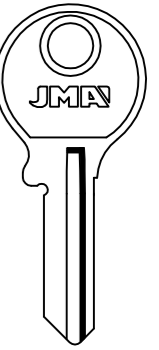

JMA
EMK-1

Concerning the marks and commercial denominations see legal warning.
 Concerniente a las marcas y denominaciones comerciales ver aviso legal.
 Marka eta izendapen komertzialiei dagokienez, ikus lege-oharra.
 Concernant les marques et dénominations commerciales voir la note dans l'index.

JMA® Opening the future

JMA® Opening the future

Beziehen auf die Marke und Handelsname sehen Sie die Notiz im Impressum.
 Relativamente às marcas e denominações comerciais, ver aviso legal.
 Jeśli chodzi o znaki i nazwy handlowe, patrz Informacje prawne.

FOR: EP PINSON®

FOR: ERA®

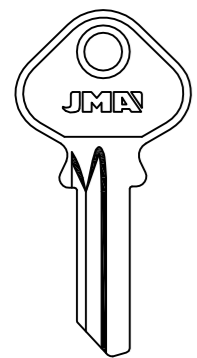

EP-1D

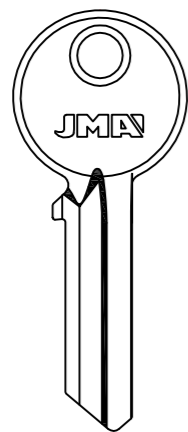

ER-1D

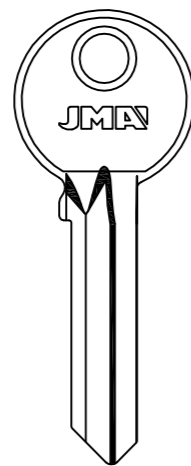

ER-2D

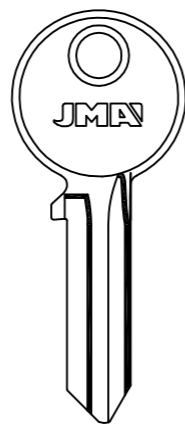

ER-3



ER-4D

LAT.

FOR: ESA®

FOR: ESLA®

FOR: ESP®

FOR: ESS®

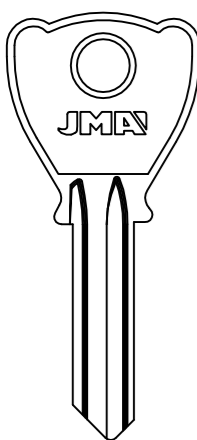

ES-1I ES-1D

FOR: NUMIDA®

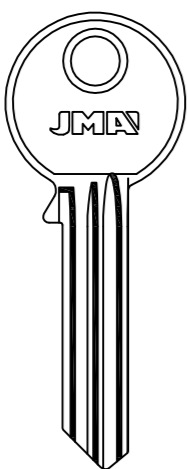

ESL-1 ESL-1D

FOR: CISA®

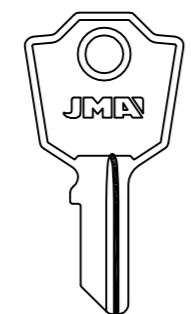

FOR: FKS®-ELEDIS®

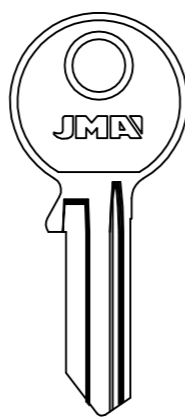

ESS-1 ESS-2

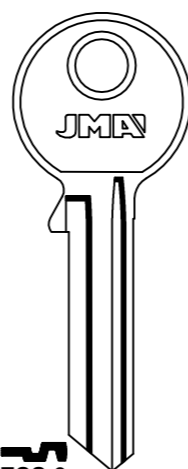

ESS-3 ESS-4

FOR: ESS®

FOR: ETAS®

FOR: EUREKA®

FOR: EURO BOX®

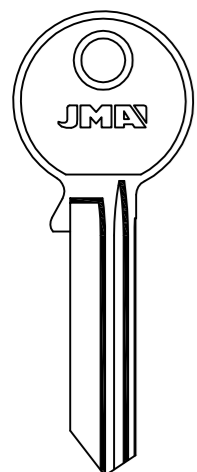

ESS-9 ESS-9D

FOR: BAB®

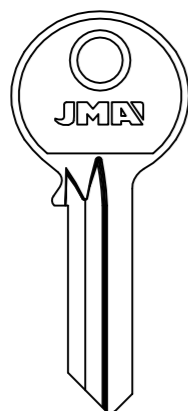

FOR: YANEDIS®

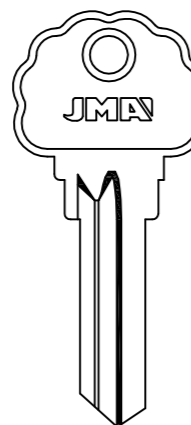

EUR-1D

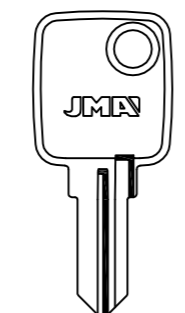

FOR: WT®

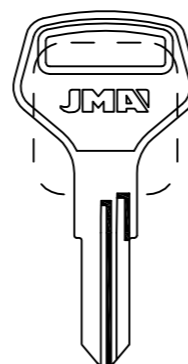

FOR: BRABANTIA®-MARS®-WEDO®

FOR: EURO LOCKS®

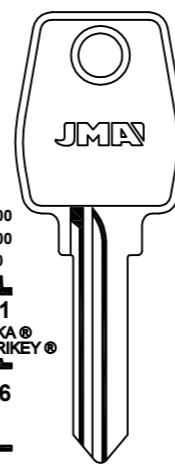

47001-48000
45000-47000
1201-1400
EU-1
FOR: EMKA®
FOR: SECURIKEY®
EU-6



EU-9 EU-10D

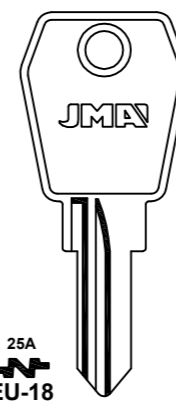

25A
EU-18



EU-13D EU-14D

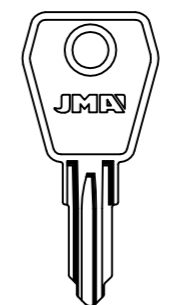

EU-3

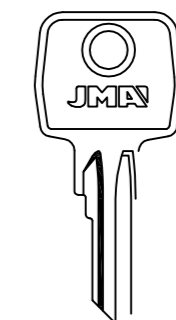

...A
458-5124



EU-4

...E
405-4324



EU-4D

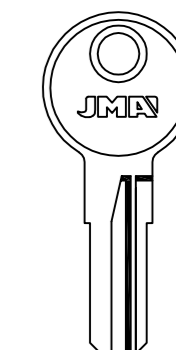

EU-7



EU-7D



EU-11

FOR: FASMA®-L.&F.®-MERONI®

FOR: EUROLOCKS®

FOR: EURO-PROFIL®

FOR: EVERGOOD®

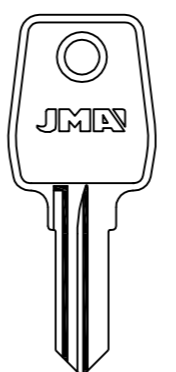

KB
1-500
EU-17



FOR: L&F®

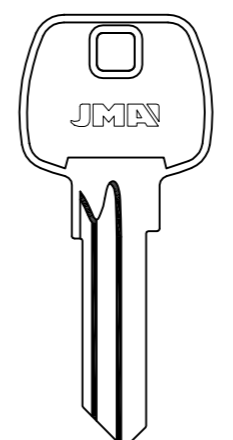

FOR: GERDA®

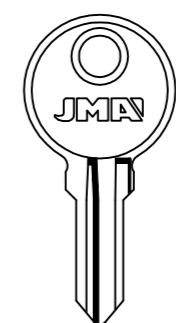

FOR: ARREGUI®

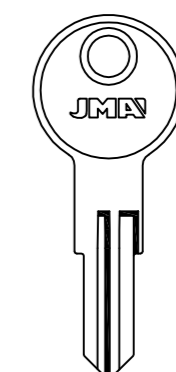

EVE-2



EVE-2D

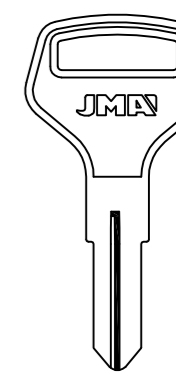

EVE-3D

FOR: EVERGOOD®

FOR: EVA®

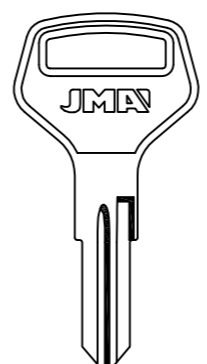

EVE-4

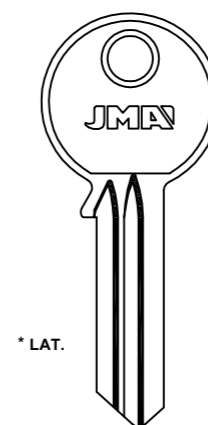

* LAT.



FOR: ELCA®



EV-1



EV-2



EV-3D



EV-13D



EV-15D



EV-25D

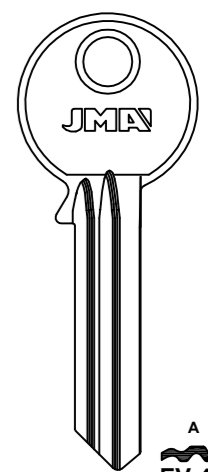

EV-4D



EV-10

Concerning the marks and commercial denominations see legal warning.
Concerniente a las marcas y denominaciones comerciales ver aviso legal.
Marka eta izendapen komertzialiei dagokienez, ikus lege-oharra.
Concernant les marques et dénominations commerciales voir la note dans l'index.

JMA® Opening the future

JMA® Opening the future

Beziehen auf die Marke und Handelsname sehen sie die Notiz im Impressum.
Relativamente às marcas e denominações comerciais, ver aviso legal.
Jeśli chodzi o znaki i nazwy handlowe, patrz Informacje prawne.

FOR: EVVA®

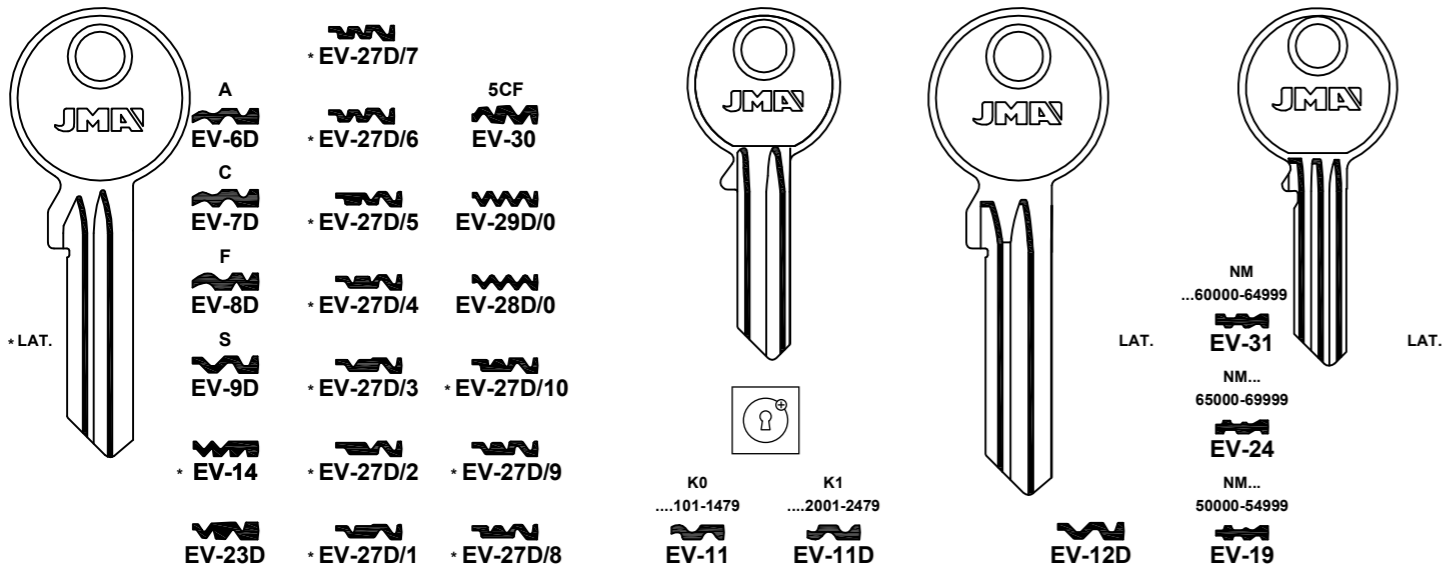

FOR: ELCA®-TRYBA®-GE GE®-EVVA TSC®-WORTH®

FOR: FAB®

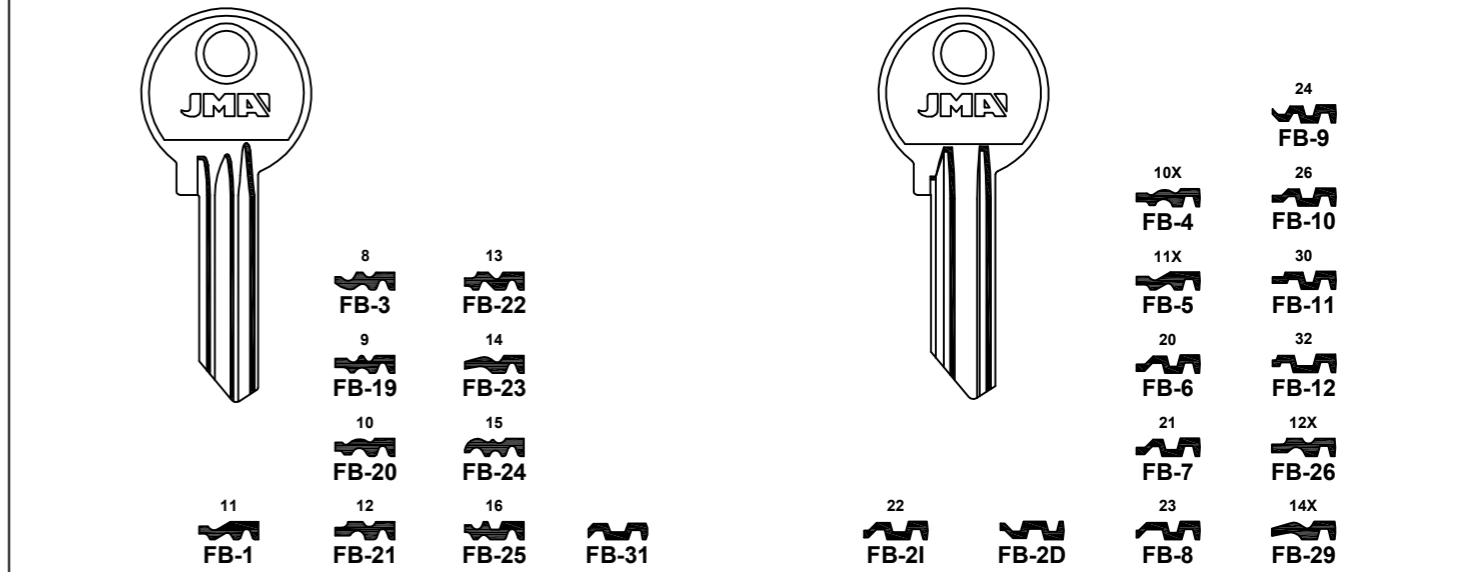

FOR: EVVA®

FOR: EXCEL®

FOR: EXPRES®

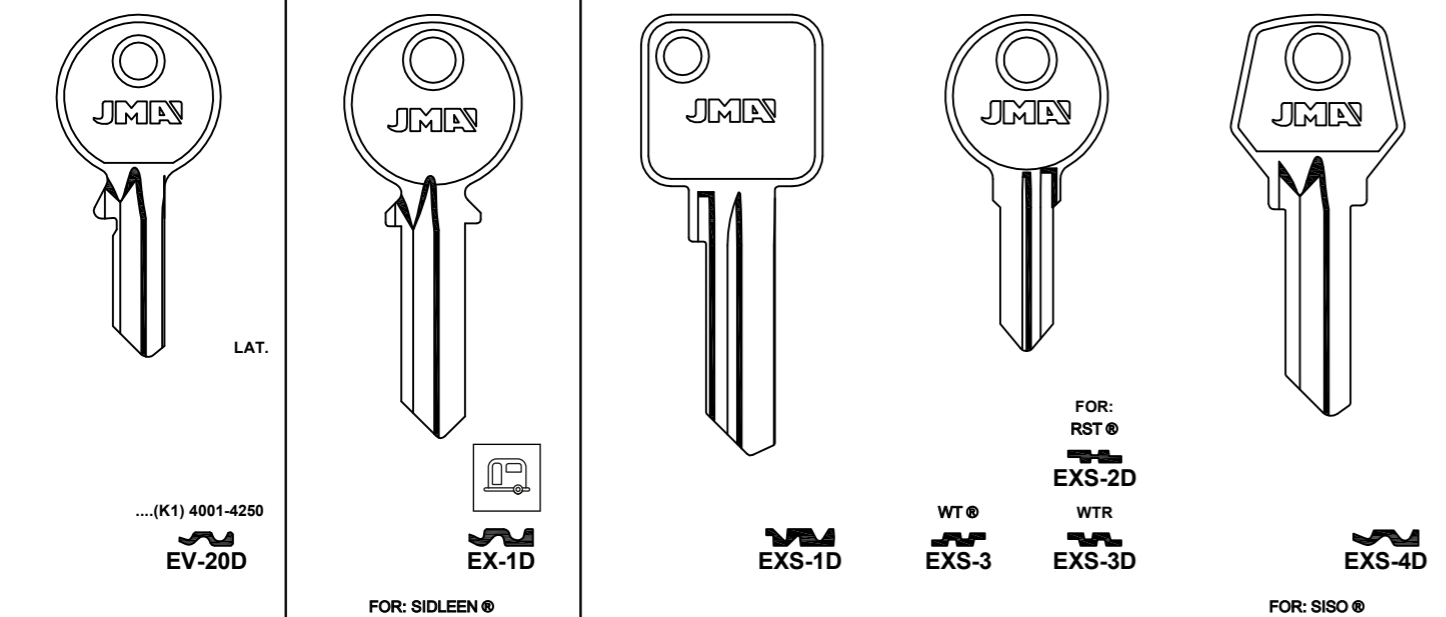

FOR: SIDLEEN®

FOR: SISO®

FOR: FAB®

FOR: FAC®

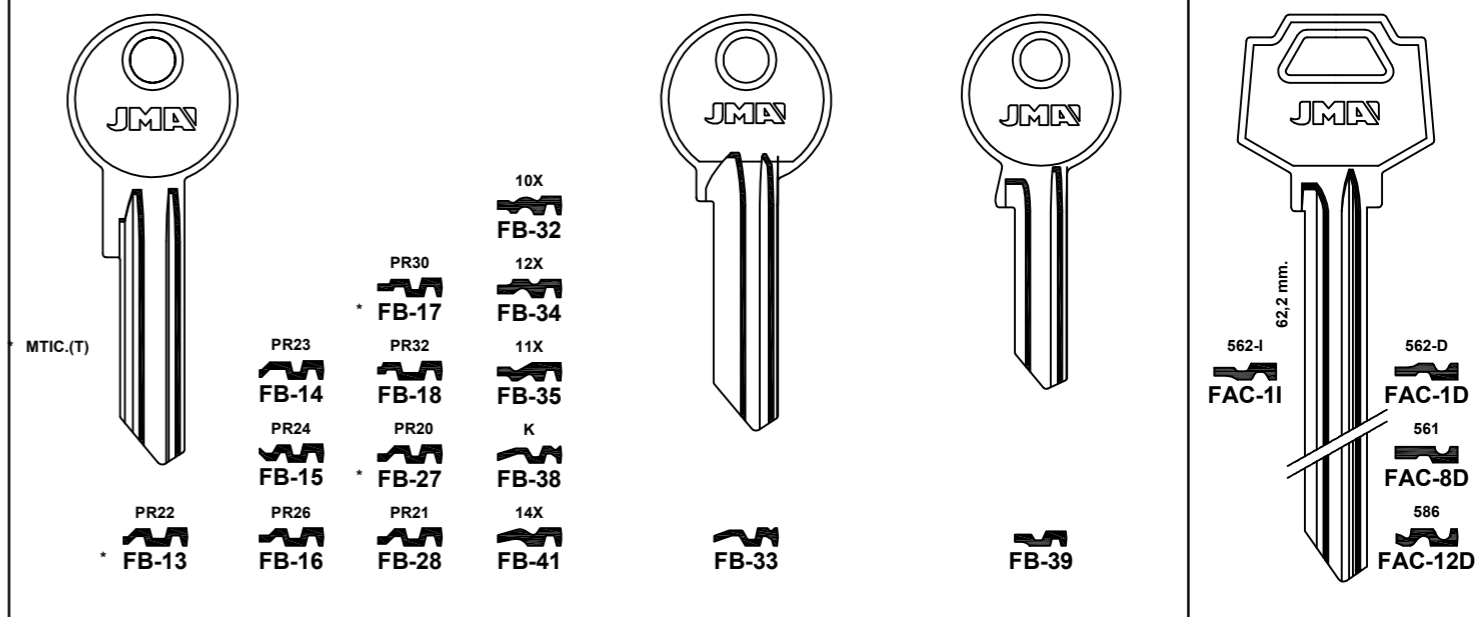

FOR: EXPRES®

FOR: EZCURRA®

FOR: FAC®

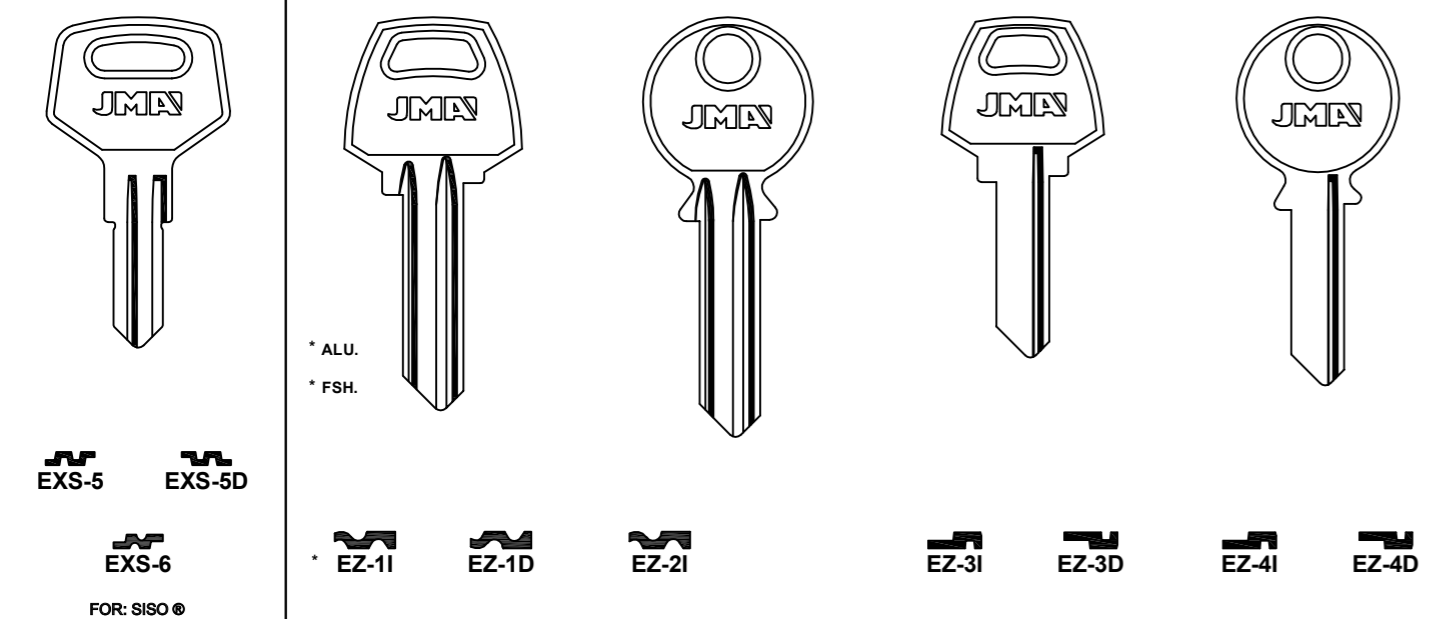

FOR: SISO®

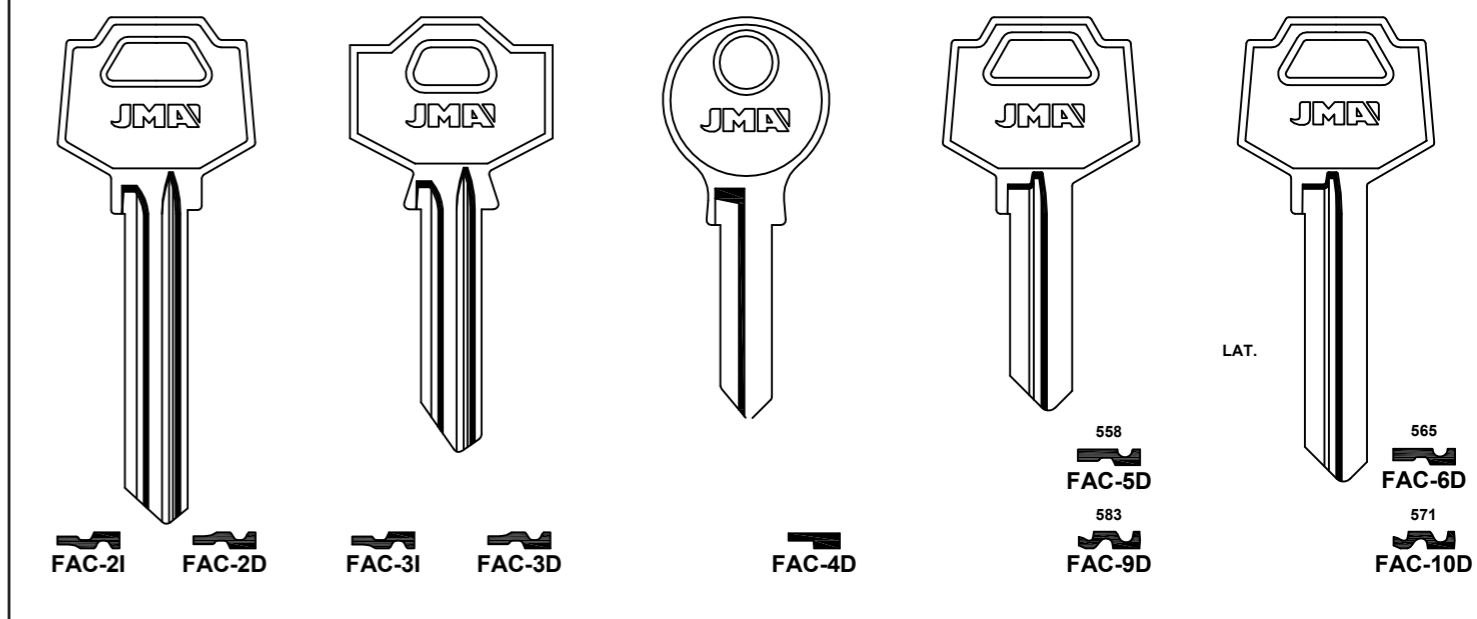

Concerning the marks and commercial denominations see legal warning.
 Concerniente a las marcas y denominaciones comerciales ver aviso legal.
 Marka eta izendapen komertzialiei dagokienez, ikus lege-oharra.
 Concernant les marques et denominations commerciales voir la note dans l'index.

JMA® Opening the future

JMA® Opening the future

Beziehen auf die marke und handelsname sehen sie die notiz im Impressum.
 Relativamente às marcas e denominações comerciais, ver aviso legal.
 Jeśli chodzi o znaki i nazwy handlowe, patrz Informacje prawne.

K01 / 45

FOR: F.F.®



FF-7D

FF-8D

FF-9D

FF-10GD

FOR: FIC®

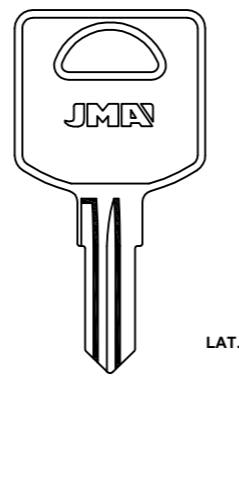

LAT.

FCS-1D

FOR: FORT®

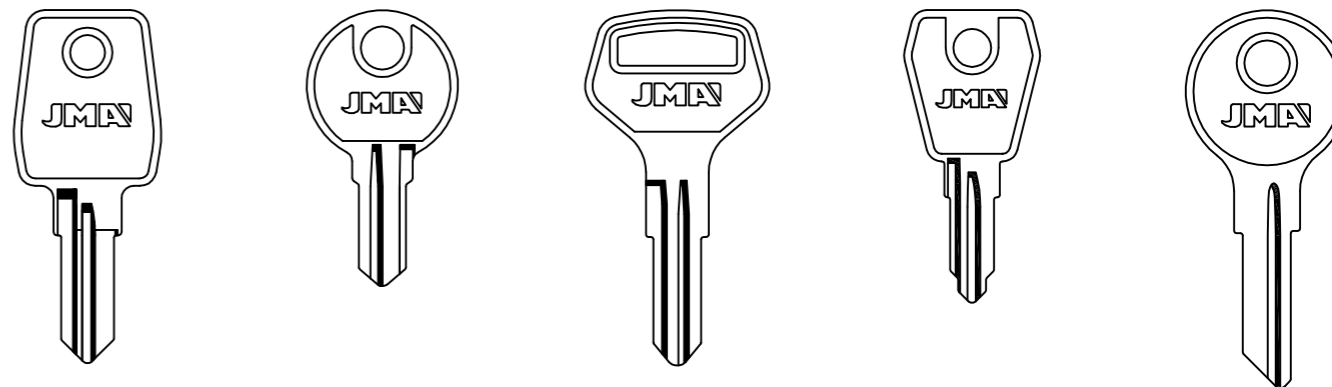

FR-1D

FR-2

FR-4

601-700
FR-7D

501-600
FR-8

FG
FR-9D

FR-11D

FOR: DAD®-LOWE&FLETCHER®

FOR: ARREGUI®

FOR: ABUS®-SECURITAL®

FOR: FICHET®

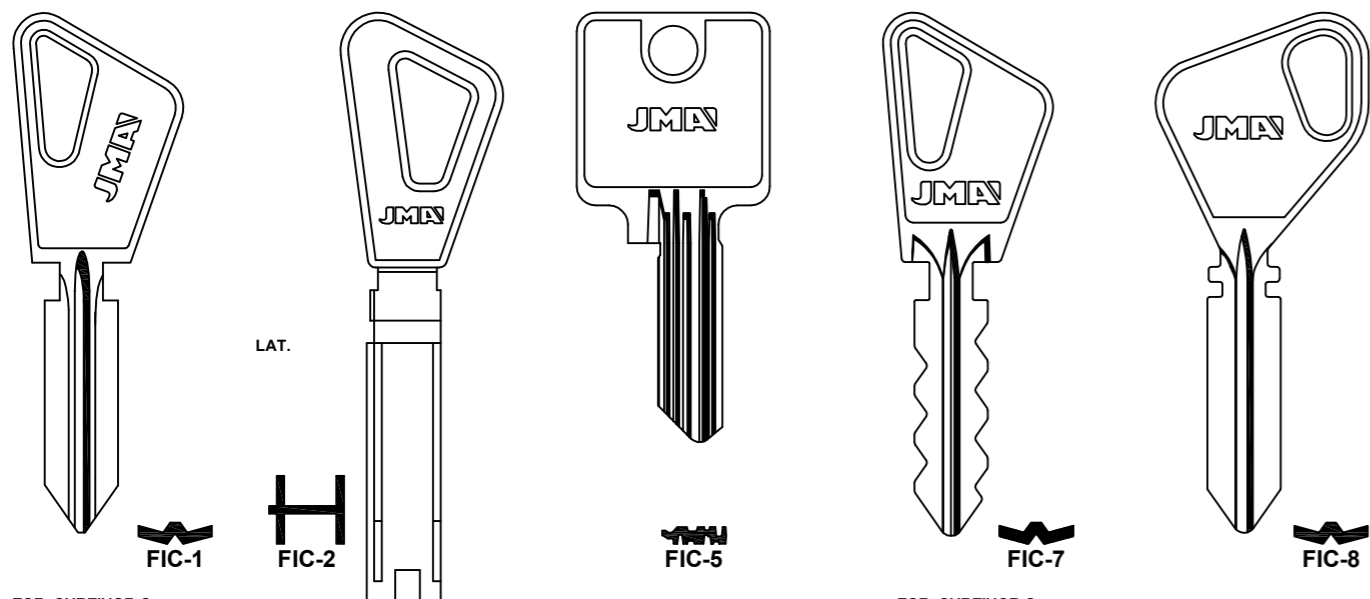

LAT.

FIC-1

FIC-2

FIC-5

FIC-7

FIC-8

FOR: SURFINOR®

FOR: SURFINOR®

FOR: FORTE®

FOR: FORTIS®

FOR: FTH®

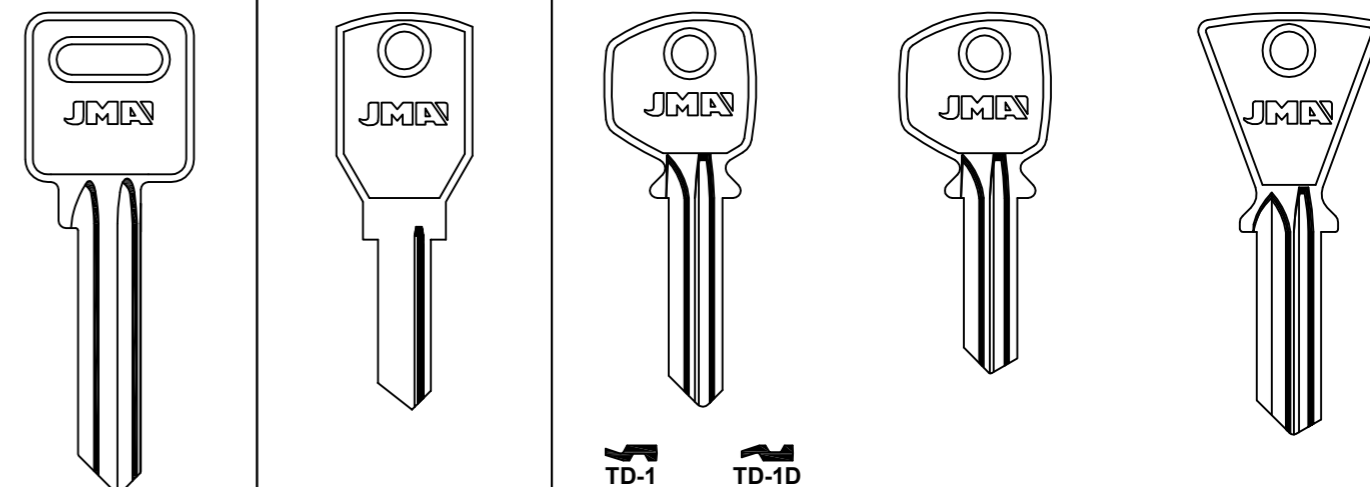

FTE-1

FTE-1D

FORTIS-2I

TD-1

TD-1D

TD-8

TD-8D

TD-2

TD-3

FOR: FICHET®

FOR: FIST®

FOR: FLORA®

FOR: FONTAINE®

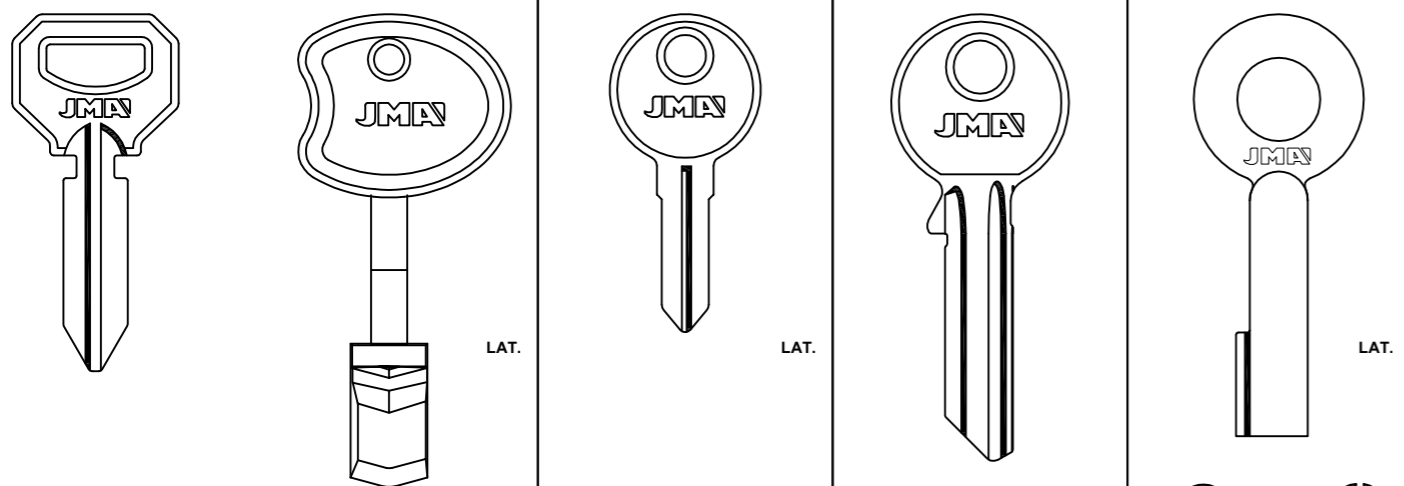

LAT.

LAT.

LAT.

FIC-9

FIC-18

FIS-1D

FLO-1

FLO-1D

FON-2E

FON-5E

FOR: TECNOR®

FOR: FLOHR®-NB®-NORDWEST®-SUKI®

FOR: PROGRES®

FOR: FTH®

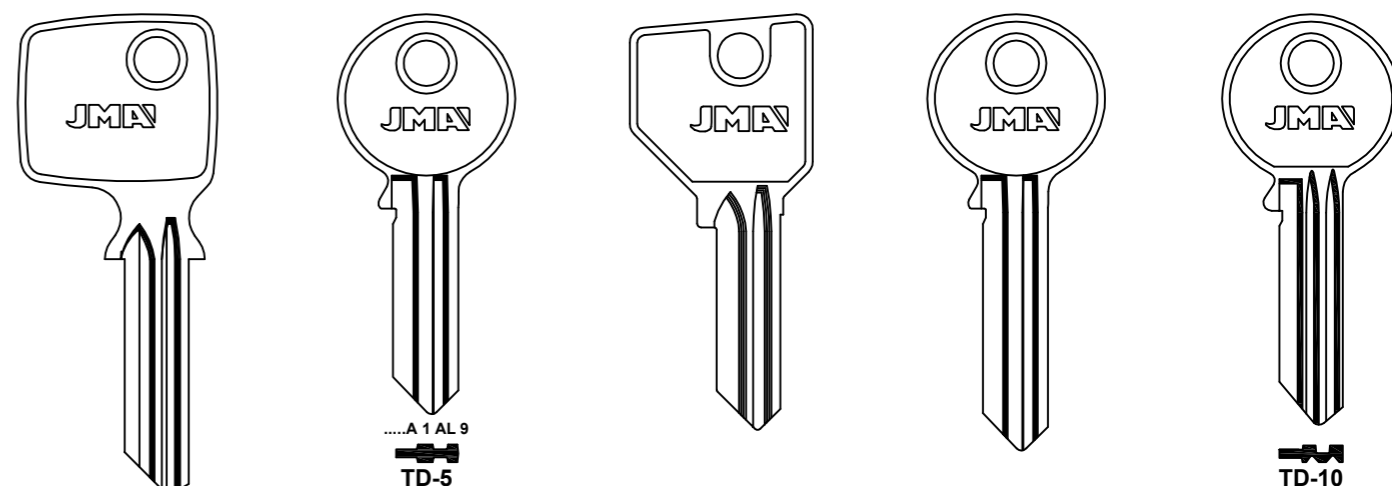

.....A 1 AL 9
TD-5

TD-4

TD-22

TD-6

.....A 1 AL 9
TD-9

TD-10

TD-21

FOR: CF®-CB®-IFAM®-JL®-NICO®-PROBAT®
FOR: CIBC®-CITY®-SUF®

Concerning the marks and commercial denominations see legal warning.
Concerniente a las marcas y denominaciones comerciales ver aviso legal.
Marka eta izendapen komertzialiei dagokienez, ikus lege-oharra.
Concernant les marques et denominations commerciales voir la note dans l'index.

JMA® Opening the future

JMA® Opening the future

Beziehen auf die marke und handelsname sehen sie die notiz im Impressum.
Relativamente às marcas e denominações comerciais, ver aviso legal.
Jeśli chodzi o znaki i nazwy handlowe, patrz Informacje prawne.

K01 / 49

FOR: FTH®

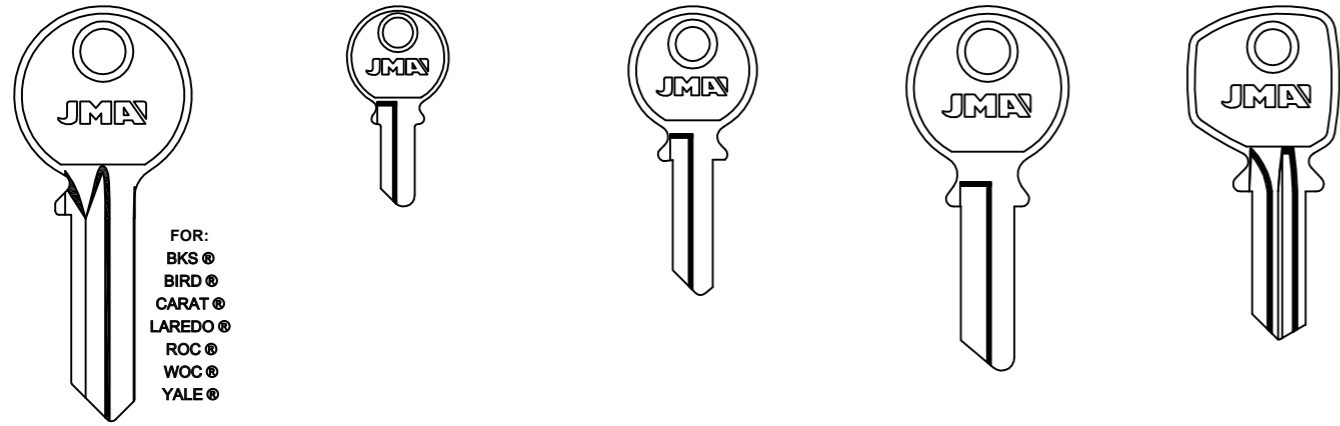

FOR:
BKS®
BIRD®
CARAT®
LAREDO®
ROC®
WOC®
YALE®

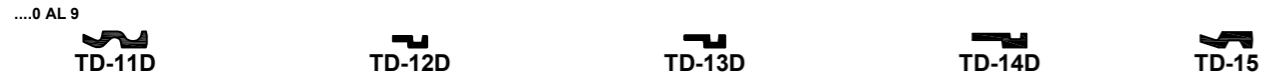

FOR: GAMET®

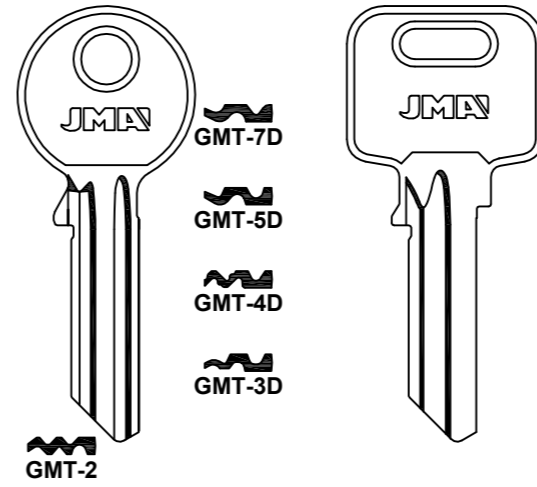

GMT-7D
GMT-5D
GMT-4D
GMT-3D



FOR: EXPRES®

FOR: GATO®

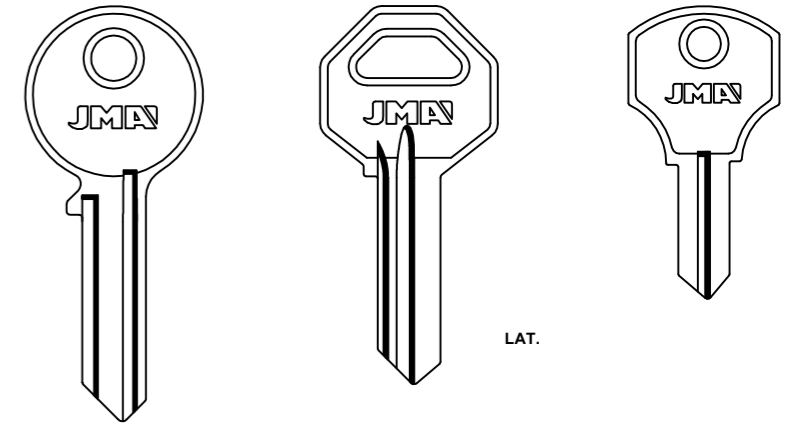

LAT. LAT.



FOR: FTH®

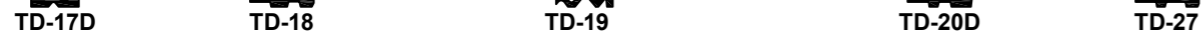
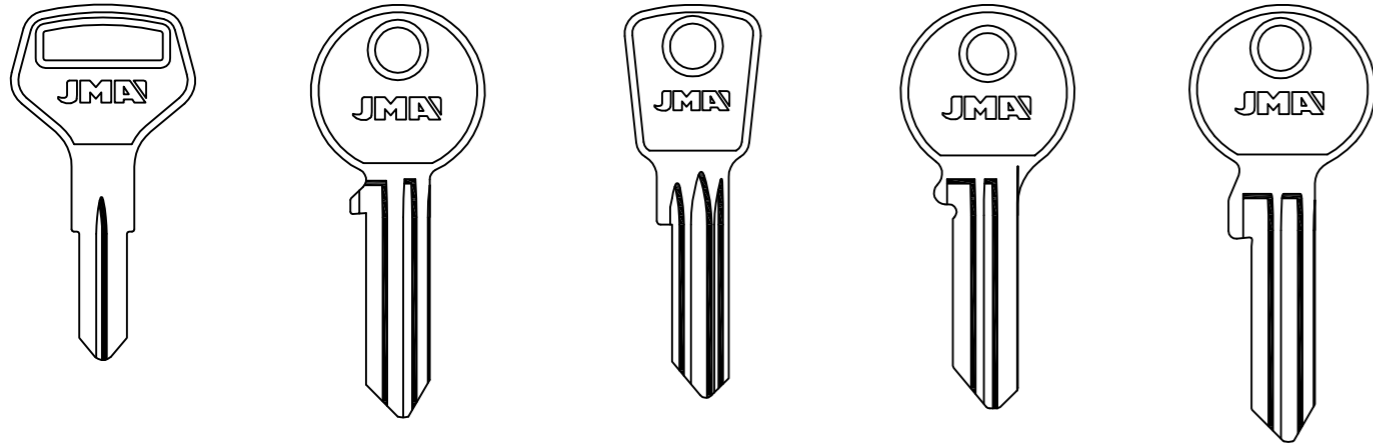

FOR: FEDERAL®

FOR: HERACLES®

FOR: GBZ®

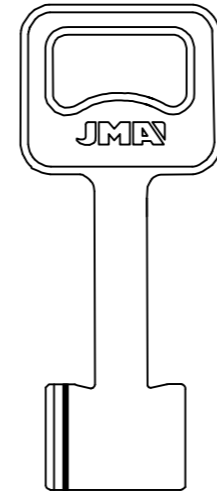

LAT.



FOR: GE-GE®

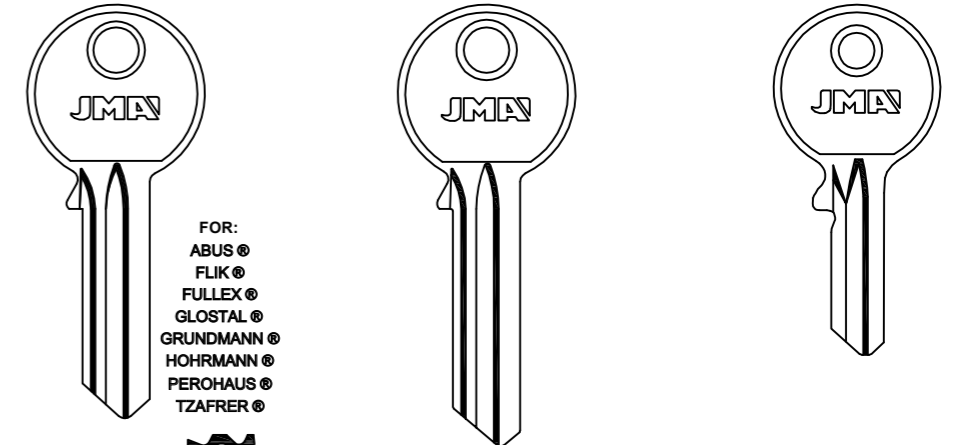

FOR:
ABUS®
FLIK®
FULLEX®
GLOSTAL®
GRUNDMANN®
HOHRMANN®
PEROHAUS®
TZAFRER®

GE-1D

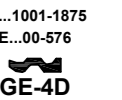
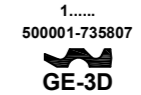

FOR: ALFA® -FINSTRAL®

FOR: LABOFA® -PEROHAUS®

FOR: FTH®

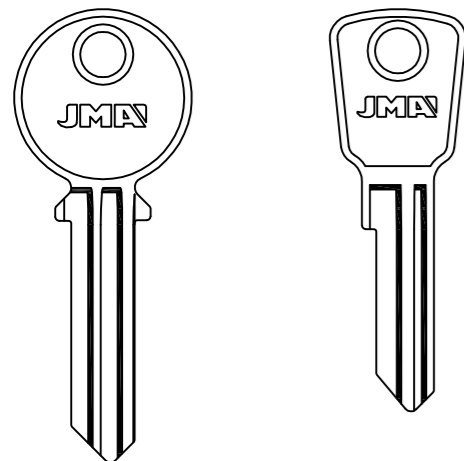

FOR: FEDERAL®

FOR: FULTON HITCH®

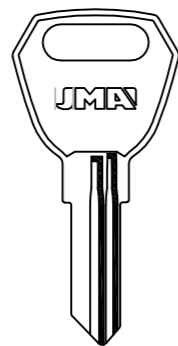

LAT.



FOR: GABON®

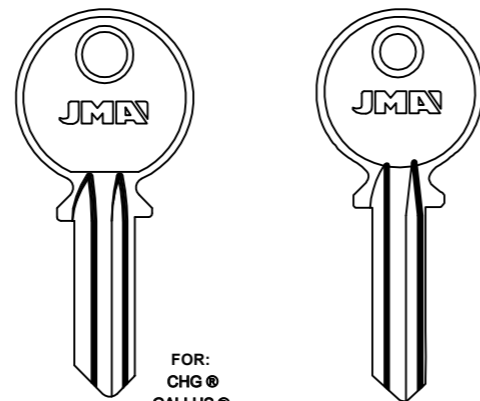

FOR:
CHG®
GALLUS®
MAXIGARD®
PICARDIE®
SOS®
WINNER®



FOR: CHG® -GALLUS® -MAXIGARD®
FOR: PICARDIE® -SOS® -WINNER®

FOR: GE-GE®

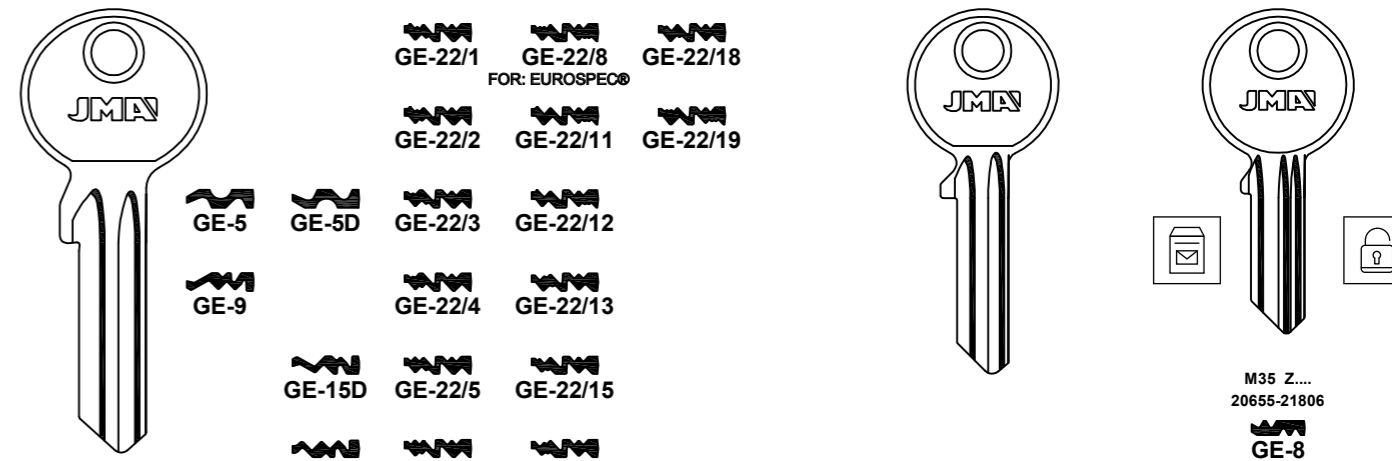

GE-22/1 GE-22/8 GE-22/18
FOR: EUROSPEC®
GE-22/2 GE-22/11 GE-22/19

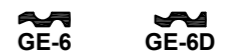
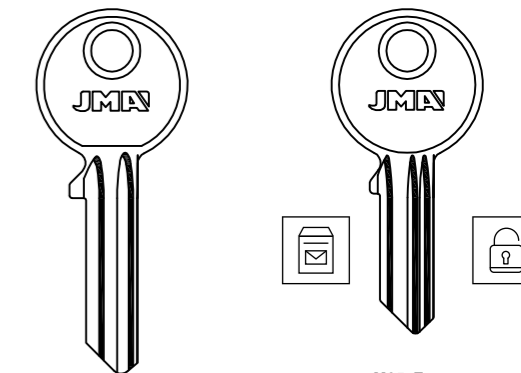

FOR: PEROHAUS®

M35 Z....
20655-21806
GE-8
M25 Z....
9135-10286
GE-7

Concerning the marks and commercial denominations see legal warning.
Concerniente a las marcas y denominaciones comerciales ver aviso legal.
Marka eta izendapen komertzialiei dagokienez, ikus lege-oharra.
Concernant les marques et denominations commerciales voir la note dans l'index.

FOR: GE GE®

FOR: GEBA®

FOR: GERA®

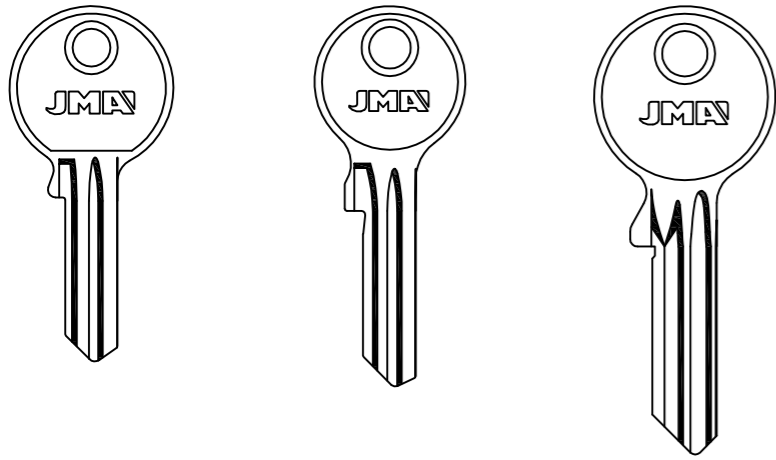

GE-10D GE-11 GE-21 GE-21D

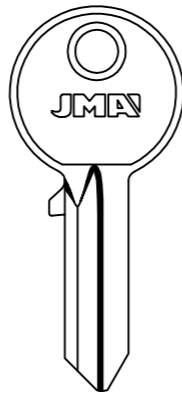

GEB-1D

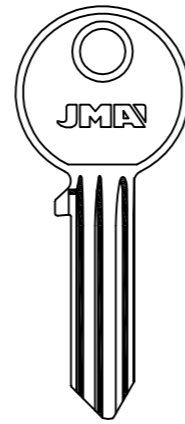

GEA-1

FOR: GERDA®



GDA-5T GDA-6D GDA-30I GDA-7D GDA-8D GDA-5B

FOR: EUROPROFIL®

FOR: EUROPROFIL®

FOR: EUROPROFIL®

FOR: GERA®

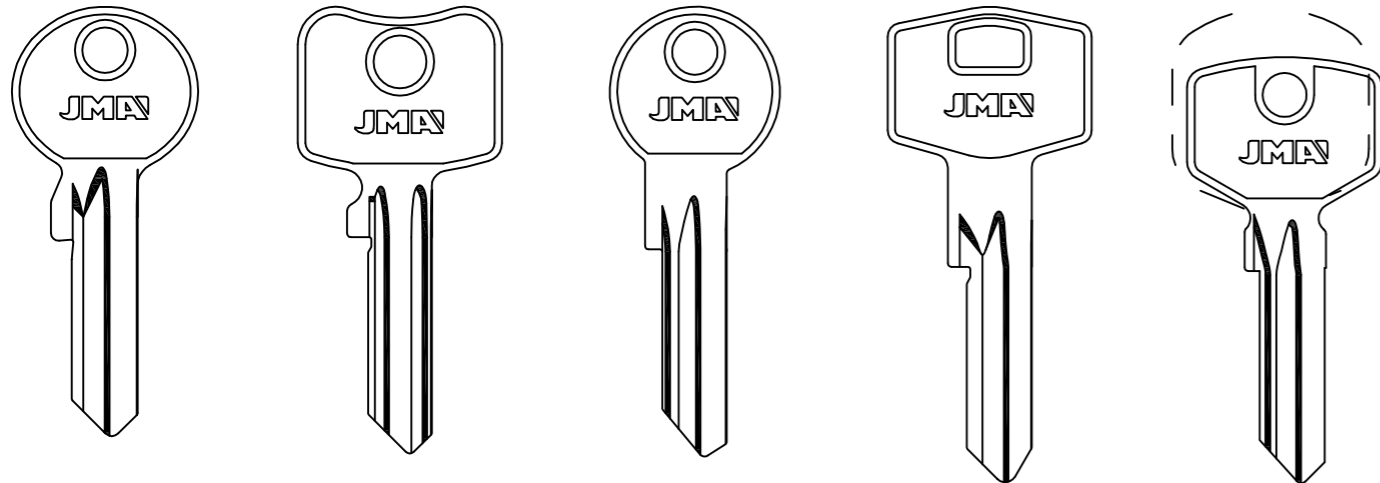

GEA-2D GEA-3 GEA-4D GEA-5D GEA-6D

PZ6900

FOR: ROTO®-BUVA®

FOR: GIBBONS®

FOR: GIUSSANI®

FOR: GLAZIEV®

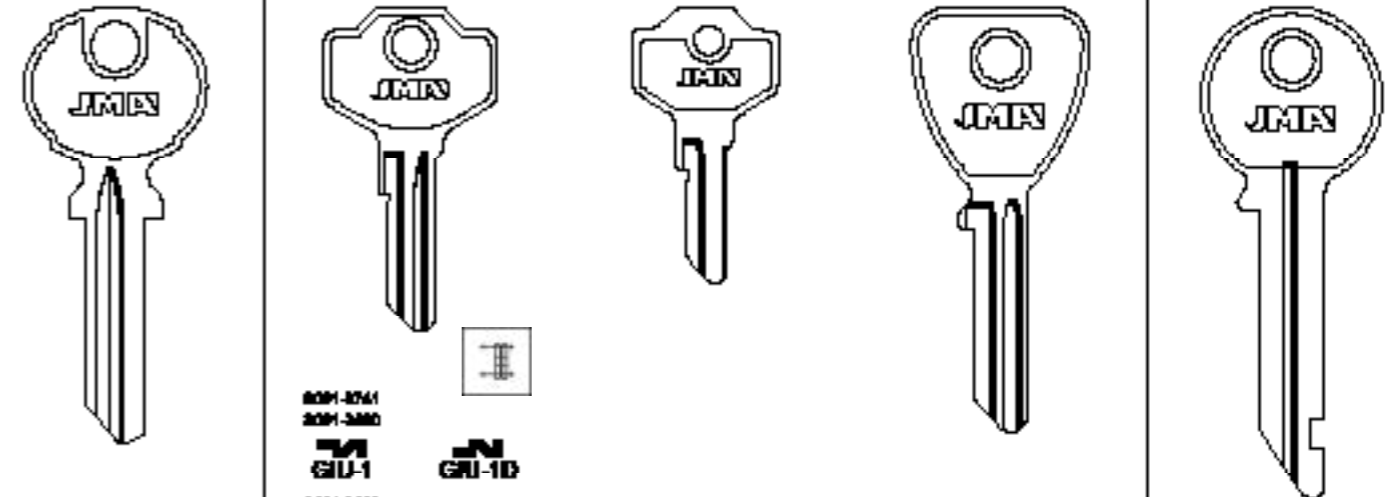

GB-1D GIU-1 GIU-2 GIU-3D GIU-4 GLA-1D

FOR: WILSON®

FOR: SIMON®-EPM®

FOR: OAL®-LINE®

FOR: GERA®

FOR: GERDA®

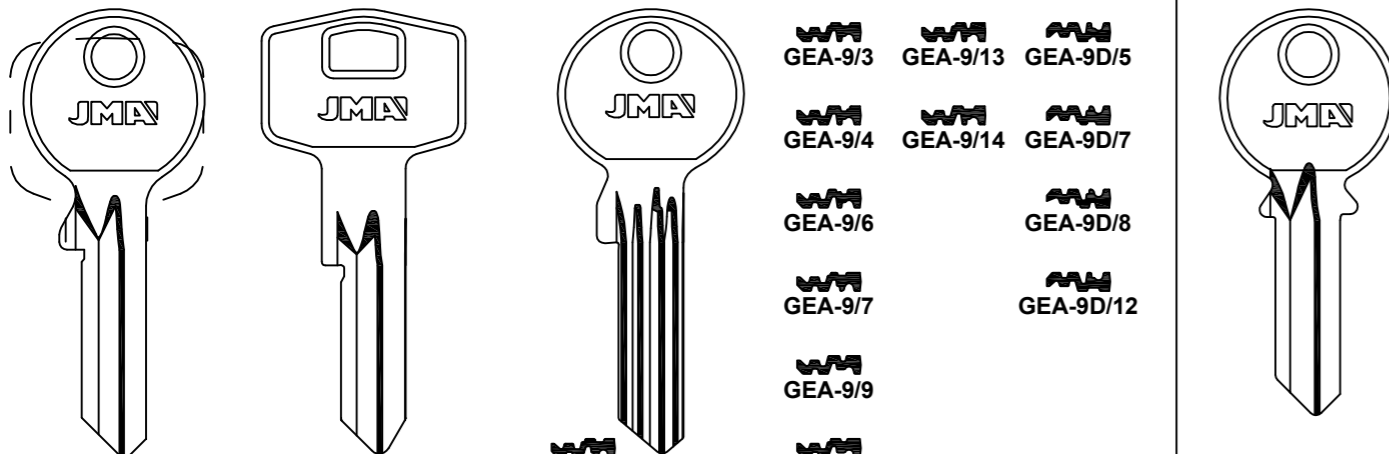

GEA-7D GEA-8D GEA-9/1 GEA-9/2 GEA-9/3 GEA-9/4 GEA-9/6 GEA-9/7 GEA-9/9 GEA-9/10 GEA-9/13 GEA-9/14 GEA-9D/5 GEA-9D/7 GEA-9D/8 GEA-9D/12 GDA-3D

FOR: GLAZIEV®

FOR: GLOBE®

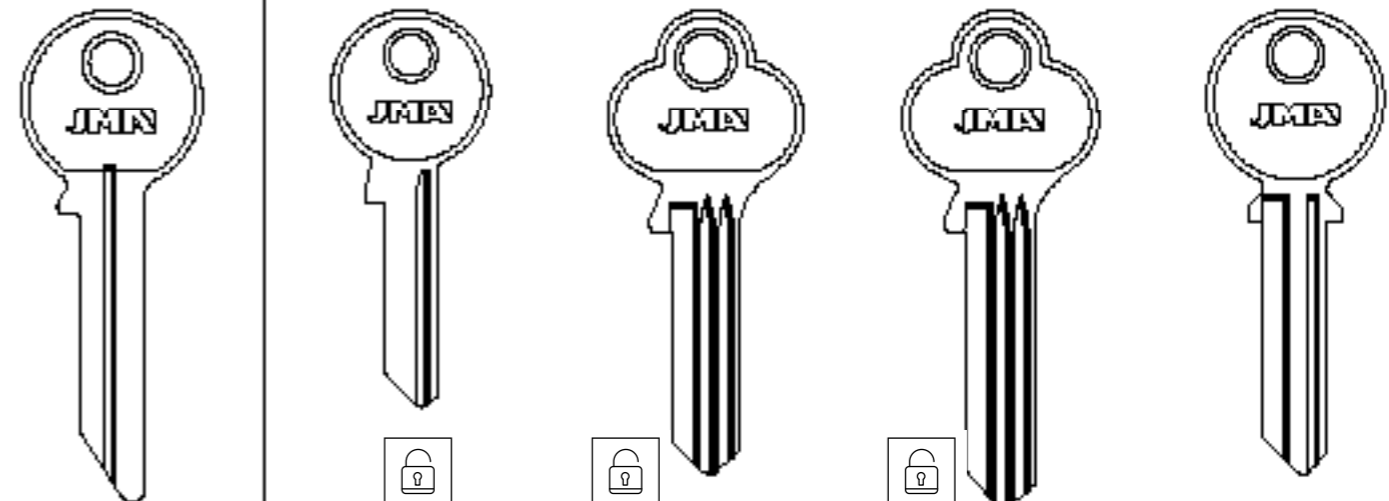

GLA-2D GLO-1I GLO-1D GLO-2 GLO-2D GLO-3 GLO-3D GLO-4I GLO-4D

FOR: LAM®

Concerning the marks and commercial denominations see legal warning.
Concerniente a las marcas y denominaciones comerciales ver aviso legal.
Marka eta izendapen komertzialiei dagokienez, ikus lege-oharra.
Concernant les marques et denominations commerciales voir la note dans l'index.

JMA® Opening the future

JMA® Opening the future

Beziehen auf die Marke und Handelsname sehen Sie die Notiz im Impressum.
Relativamente às marcas e denominações comerciais, ver aviso legal.
Jeśli chodzi o znaki i nazwy handlowe, patrz Informacje prawne.

K01 / 53

FOR: GLOBE®

GLO-5I GLO-6 GLO-6D GLO-7 GLO-7D GLO-8 GLO-8D GLO-9D

FOR: MIAN® -FORCE® FOR: GOLD DOOR®

FOR: GLOBE®

GLO-10 GLO-11 GLO-12D GLO-22 GLO-22D GLO-23 GLO-23D

FOR: GOLD DOOR® FOR: ANLO® -LUCO®

FOR: GODREJ®

GOD-3 GOD-4

FOR: SHERLOCK® FOR: SHERLOCK®

FOR: GMB®

GB-1D GB-2D

FOR: GR®

GRG-1

FOR: GTV®

GTV-2 GTV-1D GTV-2D GTV-3D GTV-4D GTV-5D

FOR: TIEFENTHAL® FOR: JOWIL® -TIEFENTHAL®

FOR: GTV®

GTV-11 LAT. GTV-12

FOR: TIEFENTHAL®

FOR: GUARD®

GUA-1 GUA-2 GUA-1D GUA-2D

FOR: FAB®

FOR: GUARD®

GUA-3 GUA-4 GUA-5 GUA-5D

FOR: GUERVILLE R.®

FOR: DEBEAURAIN® FT® MONDIAL® SE® WINNER®

GR-11 GR-12 GR-1D

FOR: PERRIER®

FOR: GUERVILLE R.®

GR-41 GR-4D GR-51 GR-5D

FOR: GUERVILLE R.®

GR-6 GR-6D GR-7 GR-7D

FOR: GUSHENG®

GUS-1

FOR: MONDIAL®

FOR: HÄFELE®

HAF-1 HAF-1D

HAF-4

Concerning the marks and commercial denominations see legal warning.
 Concerniente a las marcas y denominaciones comerciales ver aviso legal.
 Marka eta izendapen komertzialiei dagokienez, ikus lege-oharra.
 Concernant les marques et dénominations commerciales voir la note dans l'index.



Beziehen auf die marke und handelsname sehen sie die notiz im Impressum.
 Relativamente às marcas e denominações comerciais, ver aviso legal.
 Jeśli chodzi o znaki i nazwy handlowe, patrz Informacje prawne.

FOR: HeFELE®			FOR: HAGA®	FOR: HAHN&KOLB®
HAF-2	HAF-2D	TA 100-999 HAF-3D	HAG-1D	HKO-1D
FOR: WSS®-WORTH®				
FOR: HALLE®	FOR: HARKOV®		FOR: HARLOC®	
HAL-1	HAK-1D	HAK-2D	HAK-3	HAK-4
FOR: HARKOV®		FOR: HARLOC®		
HAK-5		HAR-11		
FOR: DNS®-EAGLE®-LORI®				
FOR: HAYWORTH®	FOR: HEKNA®		FOR: HELIX®	FOR: HENDERSON®
HAW-1D1001-1425 HEK-1	HEK-2	HEL-1	R 008-254 HEN-1
LAT. HAW-2D	HEK-3	HEK-5	FOR: REGENT®	
HAW-3D	FOR: METALCASTELLI®-RAUCO®-REGENT®			
HAW-4D	HEK-4 HEK-4D			
FOR: METALCASTELLI®-RAUCO®-REGENT®				

FOR: HENDERSON®	FOR: HERME®	FOR: HFM®	FOR: HOBES®		
HEN-2	HRM-1	HF-1D	HOB-1	HOB-2D	
FOR: HOK®	FOR: HORSE®		FOR: HTEC®	FOR: HTV®	
HOK-2D	HOR-1	HOR-2	HTE-1D	07 HT-1	
FOR: MEGA®	FOR: HORSE®		FOR: VAUGHN®		
HOR-2D					
FOR: HUDSON®		FOR: HUGO®	FOR: HUNIT®	FOR: HUWIL®	
HUD-2D	... 01-175 HUD-3	HGO-1	HUN-1D	W 3000-4000 A 3001-4000 HUW-1	
FOR: HUDSON®		FOR: HUGO®		FOR: STRAFOR®-STEELCASE®-WORTH®	
HUD-3D		FOR: FTH®		HUW-1D	

Concerning the marks and commercial denominations see legal warning.
 Concerniente a las marcas y denominaciones comerciales ver aviso legal.
 Marka eta izendapen komertzialiei dagokienez, ikus lege-oharra.
 Concernant les marques et dénominations commerciales voir la note dans l'index.

JMA® Opening the future

JMA® Opening the future

Beziehen auf die marke und handelsname sehen sie die notiz im Impressum.
 Relativamente às marcas e denominações comerciais, ver aviso legal.
 Jeśli chodzi o znaki i nazwy handlowe, patrz Informacje prawne.

FOR: HUWIL®

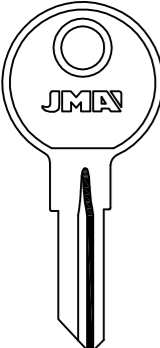

HUW-2

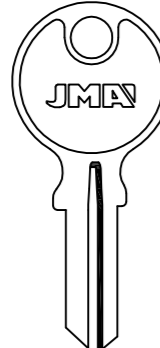

HUW-N

N
0005-1878
N
2001-2204

FOR: TECNO® - WÜRTH®

FOR: IBEAR®

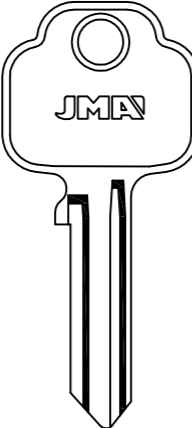

IB-1



IB-2

FOR: ICA®

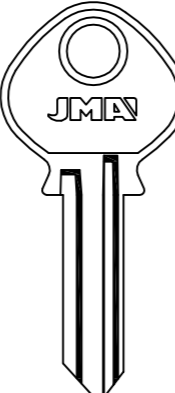

ICA-1

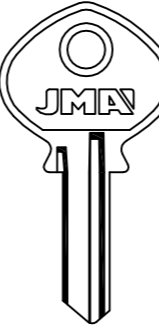

ICA-4IP

FOR: ICA®

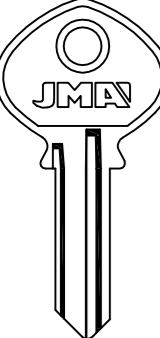

ICA-5IP

FOR: ICSA®



ICS-1D

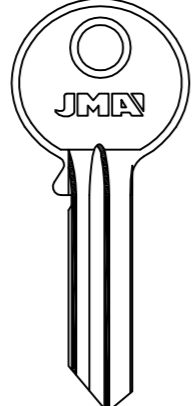

ICS-2D

FOR: ORLANDO® - REMO® - ZANI®

FOR: IFAM®



IF-11

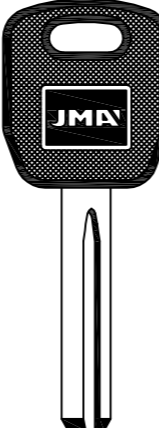

IF-3.P

ALP.

FOR: JOMA®

FOR: IFAM®

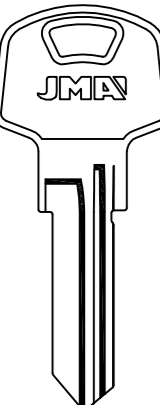

IF-5

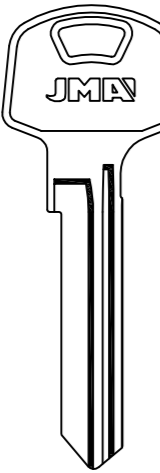

IF-7

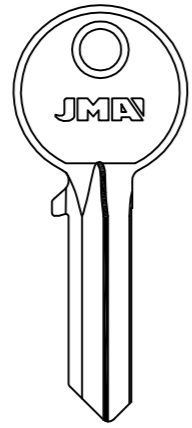

IF-10D

F5S



IF-15



IF-120



IF-D20

FOR: TEM®

FOR: ABUS® - JOMA® - TEM® - TESLA®

FOR: IFAM®

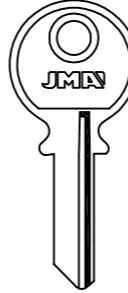

IF-125

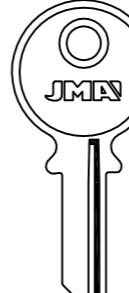

IF-D25



IF-130



IF-D30

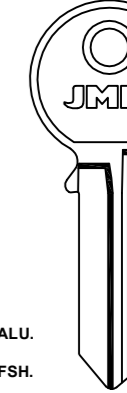

IF-140



IF-35



IF-140L



IF-150



IF-45/55

IF-151

ALU.*

*** ALU.**

*** ALU.**

*** FSH.**

FOR: BATU® - FADE® - JOMA®

FOR: GUARD® - RIPA® - TEM®

FOR: JOMA®

FOR: RIPA®

FOR: RIPA®

FOR: IFAM®

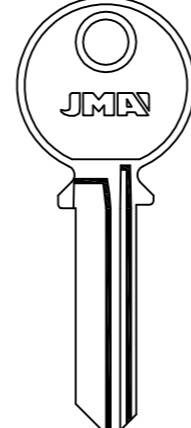

IF-160/70

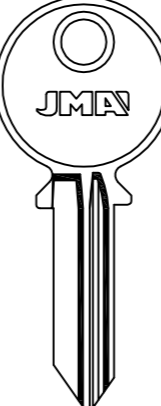

IF-60/70

FOR: IGS®



IGS-1

FOR: IFAM®



ZE-1



ZE-2



ZE-6

SN4

SN3

SN2

N2

FOR: BRUMME® - OTIS®

FOR: IKS®



ZE-1D



ZE-2D



ZE-6D

SN1

N1

M

FOR: BRUMME® - OTIS®

FOR: IKS®



ZE-9D

1 AL 9 AL 0

A-B-C-D-E-F-G-H-I-L



ZE-5I



ZE-5D







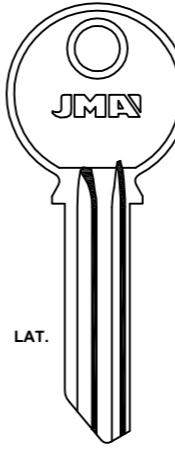



















































ZE-7D

FOR: IKS®



ZE-8

LAT.

Concerning the marks and commercial denominations see legal warning.
 Concerniente a las marcas y denominaciones comerciales ver aviso legal.
 Marka eta izendapen komertzialiei dagokienez, ikus lege-oharra.
 Concernant les marques et dénominations commerciales voir la note dans l'index.

JMA® Opening the future

JMA® Opening the future

Beziehen auf die Marke und Handelsname sehen sie die Notiz im Impressum.
 Relativamente às marcas e denominações comerciais, ver aviso legal.
 Jeśli chodzi o znaki i nazwy handlowe, patrz Informacje prawne.

FOR: IKON®

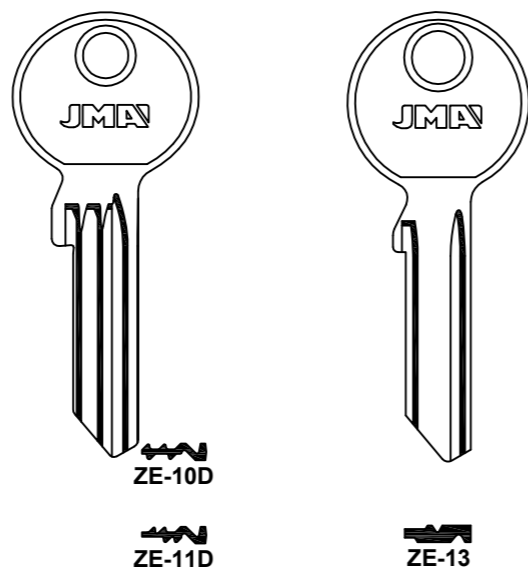
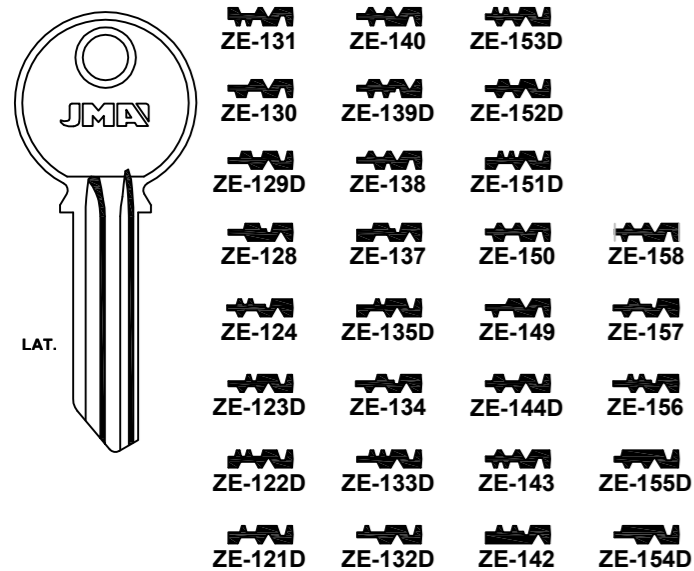

FOR: IKON®

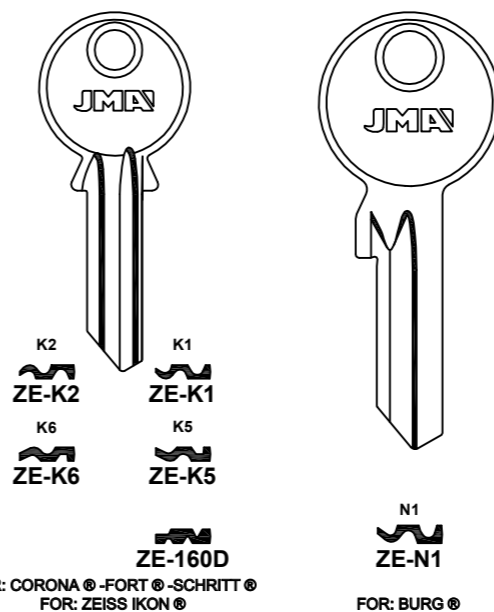

FOR: ILARGI®

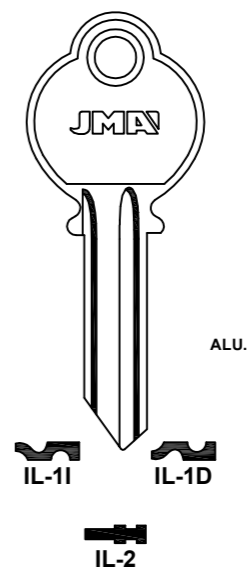

FOR: ILCO®

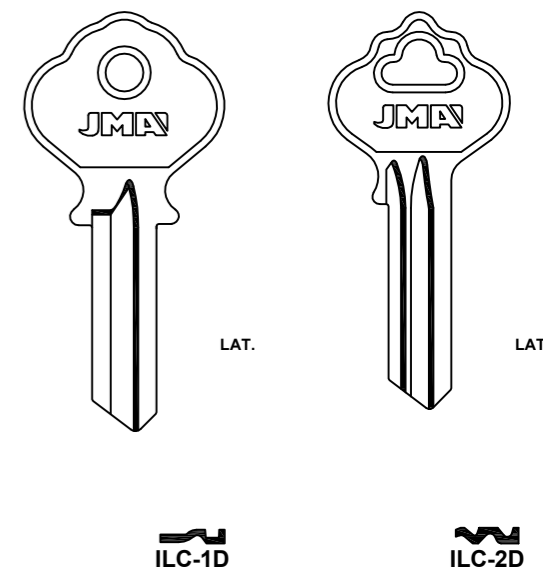

FOR: IKON®

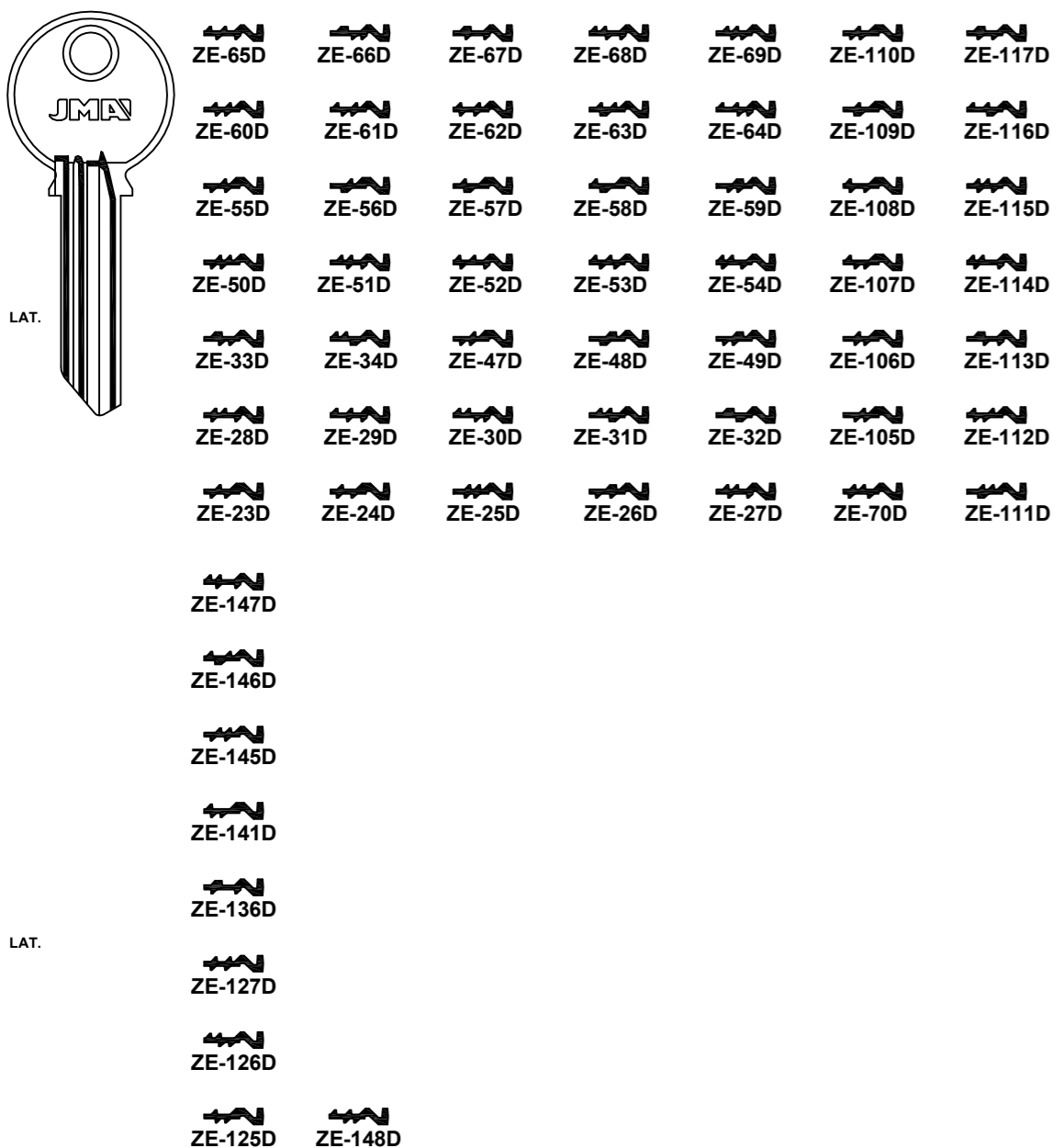

FOR: IKON®

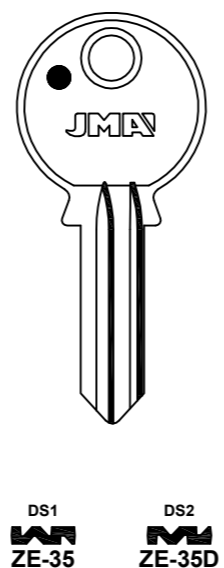

FOR: IKON®

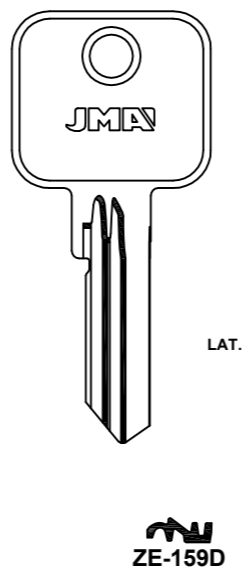

PERFIL Z SERIE 400

FOR: ILCO®

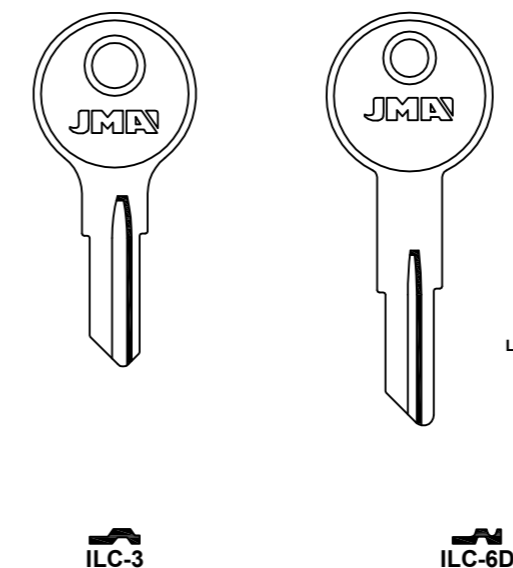

FOR: ILLINOIS®

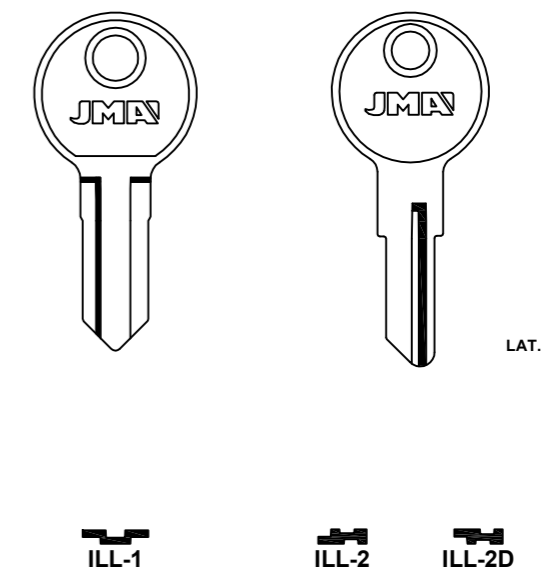

FOR: ILS®

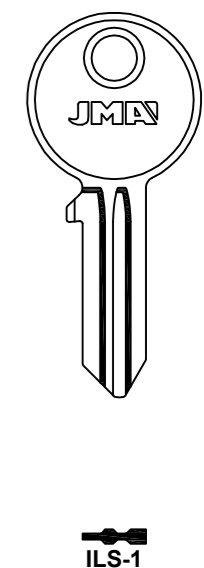

FOR: IMB®

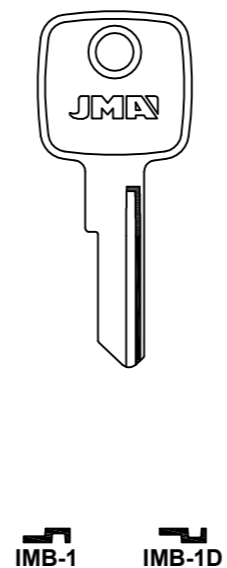

FOR: INGERSOLL®

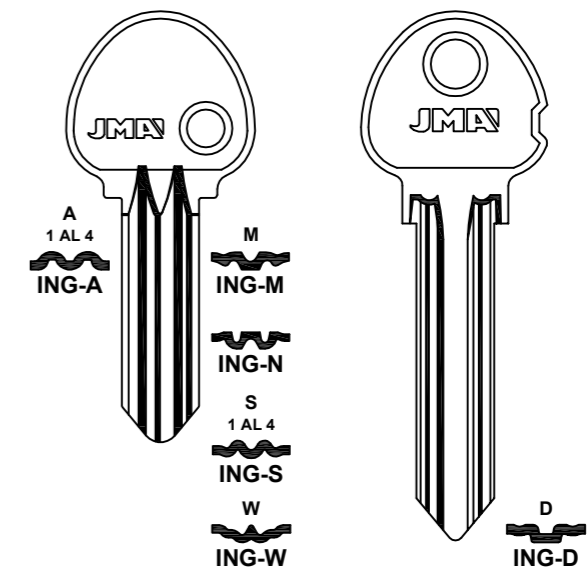

FOR: INT®

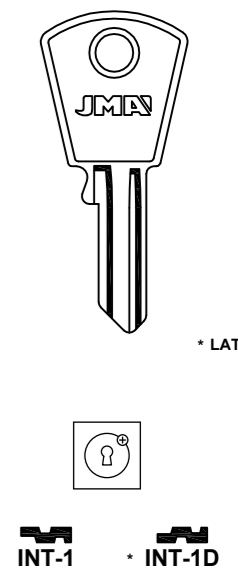

Concerning the marks and commercial denominations see legal warning.
 Concerniente a las marcas y denominaciones comerciales ver aviso legal.
 Marka eta izendapen komertzialiei dagokienez, ikus lege-oharra.
 Concernant les marques et denominations commerciales voir la note dans l'index.

JMA Opening the future

JMA Opening the future

Beziehen auf die Marke und Handelsname sehen sie die Notiz im Impressum.
 Relativamente às marcas e denominações comerciais, ver aviso legal.
 Jeśli chodzi o znaki i nazwy handlowe, patrz Informacje prawne.

FOR: ISEO®

ALU. • ALU. • WColor

IS-4 IS-5D
1-2000
 Y.....1-2000
 0 AL 8 IS-7D
 IS-8 IS-8D
 IS-18D
 F5
 IS-3D

1 AL 5 F5
 IS-11 IS-1D IS-21 IS-2D IS-31 IS-3D IS-19D IS-3D

FOR: TESA®

FOR: ISEO®

IS-21D F3 IS-15 IS-16D F6 IS-17D

VBE.....000001-014970
 A/Z A/Z A/Z.....1-48568

FOR: ISEO SILVER®

FOR: IVANA®

IV-1 IV-2D IV-3D

FOR: ISUZU®

LAT. ISU-5

FOR: ITO®

ITO-1D

FOR: JARDI®

JAR-11 JAR-1D JAR-21 JAR-2D JAR-3 JAR-6 JAR-6D

FOR: JARDI®

JAR-4D JAR-5I JAR-5D

FOR: JINLONG®

JIN-1D

FOR: JIP®

JIP-11 JIP-1D

FOR: JIS®

ALU. FSH. JIS-1D

FOR: JIS®

ALU. ALP. JIS-21 JIS-31 JIS-3D JIS-4.P

FOR: SEMEL®

FOR: JOMA®

JOM-1D

FOR: JOVI®

JO-1

FOR: JOWIL®

JWL-1D JWL-3D JWL-4D JWL-9 JWL-9D JWL-2D JWL-5 JWL-6 JWL-7D

FOR: ESZ® FHUR® GTV® JÜNGST® MERCUR® OSKO® PANTHER® TIEFENTHAL® TRITON® VOKO® WEPA®

FOR: GTV®

FOR: JOWIL®	FOR: JPM®			
 LAT. 				

FOR: KAZAN®



KAZ-4 KAZ-5 KAZ-5D KAZ-6 KAZ-7

FOR: KENWORTH®

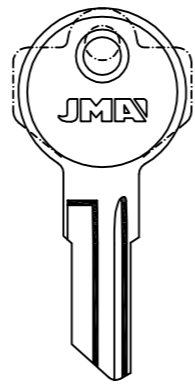

C....
250-499
1701-1950
KEN-1 KEN-1D

FOR: BASCO®-BRIGGS&STRATTON®-YALE®

FOR: KREMENCHUG®

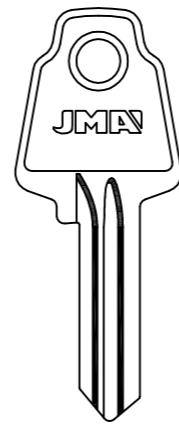

KRE-1D

FOR: KWIKSET®

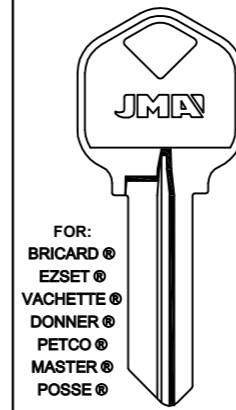

FOR:
BRICARD®
EZSET®
VACHETTE®
DONNER®
PETCO®
MASTER®
POSSE®

1 AL 7
KWI-1

FOR: BRICARD®-EZSET®-VACHETTE®

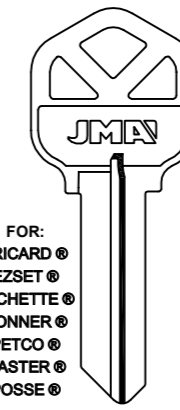

FOR:
BRICARD®
EZSET®
VACHETTE®
DONNER®
PETCO®
MASTER®
POSSE®

1 AL 7
KWI-1K

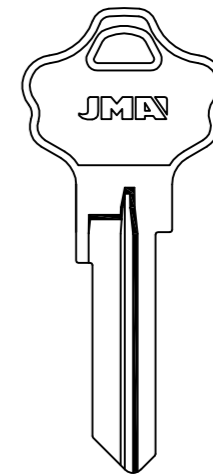

KWI-2D

FOR: TITAN®

LAT.

FOR: KYNNARPS®

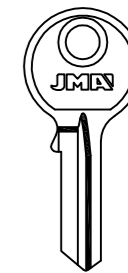

KNA-1D

FOR: KJV®

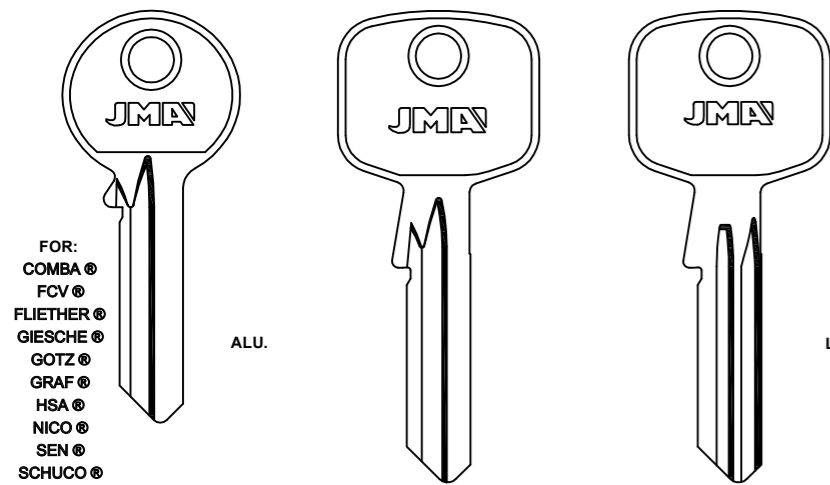

FOR:
COMBA®
FCV®
FLIETHER®
GIESCHE®
GOTZ®
GRAF®
HSA®
NICO®
SEN®
SCHUCO®

ALU.

LAT.

KJV-1 KJV-2 KJV-3

FOR: COMBA®-FCV®-FLIETHER®-GIESCHE®
FOR: GOTZ®-GRAF®-HSA®-NICO®-SCHUCO®-SEN®

FOR: KICHINEV®

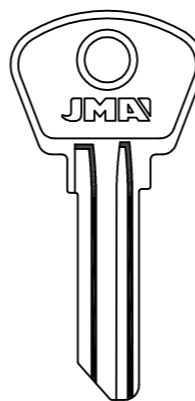

KIC-1

- KJV-O
- KJV-N
- KJV-M
- KJV-L
- KJV-F
- KJV-E
- KJV-D
- KJV-C

FOR: LAFONTE®

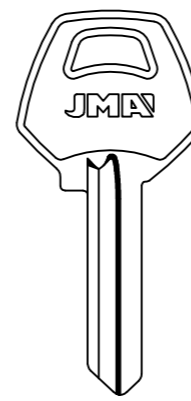

LAF-1D

FOR: LAPERCHE®

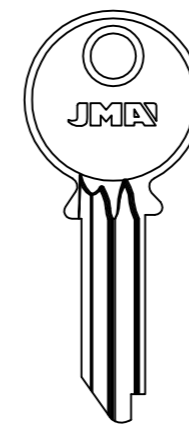

DM
LAP-1

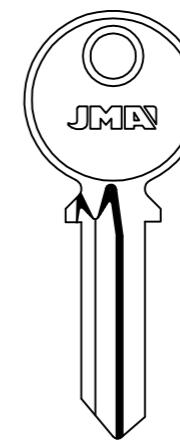

LAP-2D

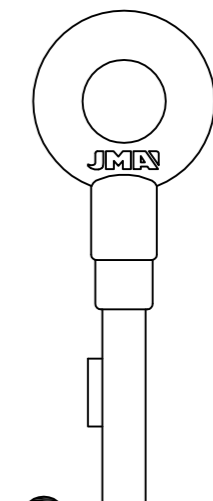

LAP-2E

LAT.

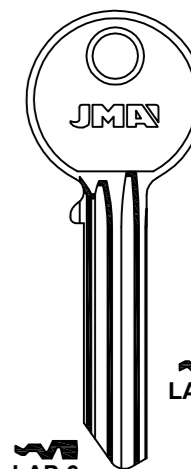

LAP-3D

LAX
LAP-7D

LAP-6

LAP
LAP-3D

FOR: GEMM®-RONIS®

FOR: KIFERM®

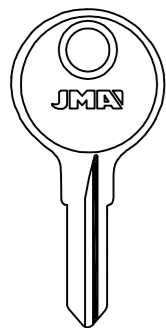

KIF-1 KIF-1D KIF-2D

FOR: KIROVMACH®

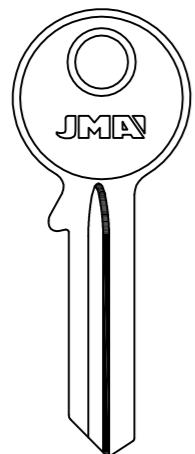

KIR-1D

FOR: KP®

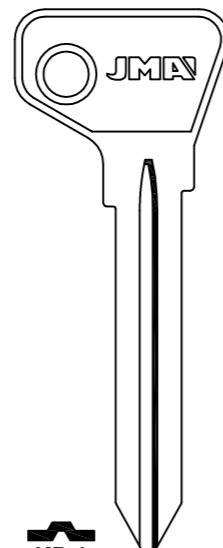

KP-1

FOR: KRAMATORSK®

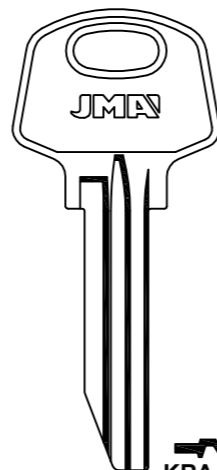

KRA-1D KRA-2

FOR: LAPERCHE®

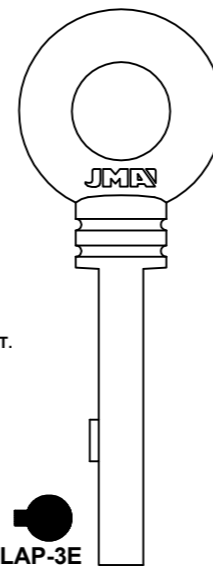

LAT.

LAP-3E

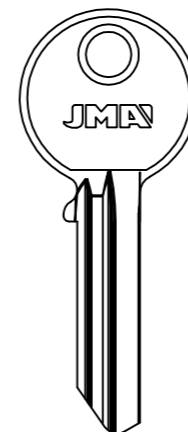

LAP-5D

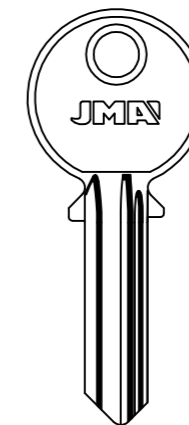

LAP-9 LAP-9D

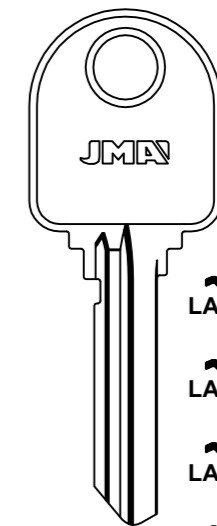

LAP-28D
LAT
LAP-29D
LAV
LAP-30D
LAR
LAP-34D

FOR: GEMM®-RONIS®

FOR: GEMM®-RONIS®

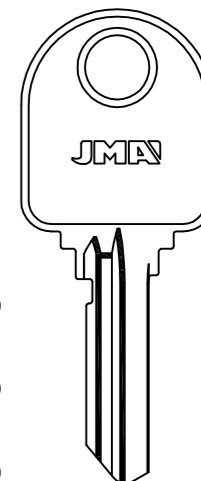

LAP-42D
X
LAP-43D
T
LAP-44D
V
LAP-45D
R
LAP-46D

FOR: GEMM®-RONIS®

Concerning the marks and commercial denominations see legal warning.
Concerniente a las marcas y denominaciones comerciales ver aviso legal.
Marka eta izendapen komertzialiei dagokienez, ikus lege-oharra.
Concernant les marques et dénominations commerciales voir la note dans l'index.

FOR: LAPERCHE®

- ADA
LAP-53
- BEA
LAP-57
- ADD
LAP-71
- BDC
LAP-88
- AEB
LAP-93
- BFB
LAP-98

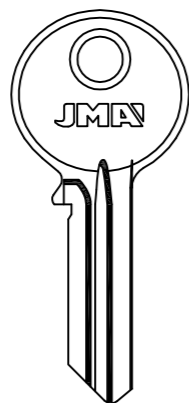
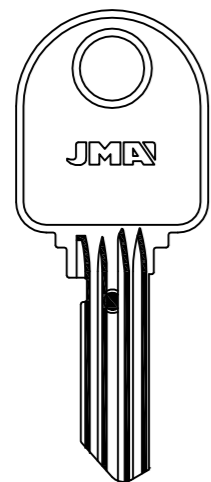

LAP-96D

FOR: VACHETTE®

FOR: LAPORTE®

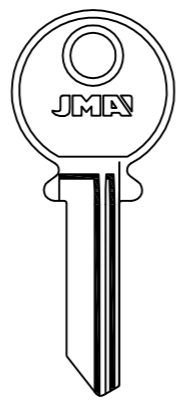

LPO-1

FOR: LAPORTE®

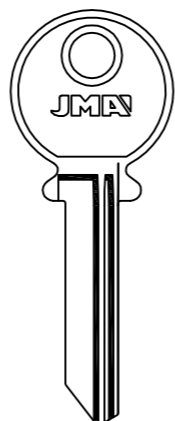

LPO-2

FOR: LAPORTE®

FOR: LAS®

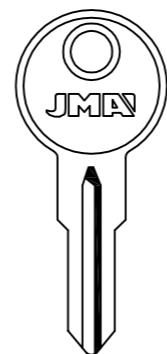

AX
001-224
LAS-AX/L

FOR: ATAL® - HEFELE® - KIFERM® - RENZ®

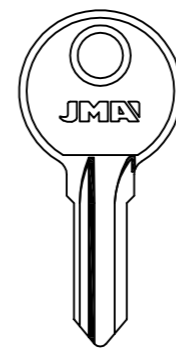

R
001-224
LAS-R

FOR: LAS®

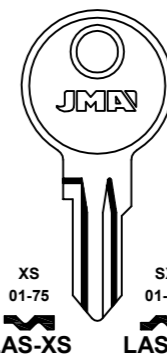

XS
01-75
LAS-XS

FOR: LAS®

FOR: LASBOLAGET®

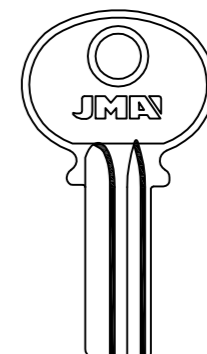

LASB-1

FOR: LASBOLAGET®



LASB-2

FOR: LASBOLAGET®

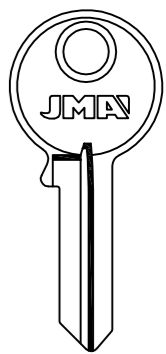

LASB-3D

FOR: LASBOLAGET®

FOR: LEGALLAIS®

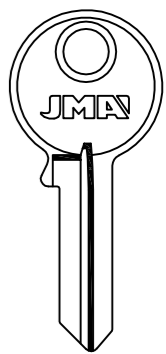

LEA-1D

FOR: LEGALLAIS®

FOR: LARK®

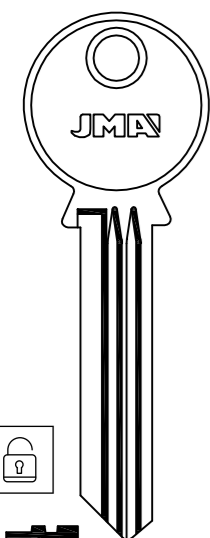

LAR-11

FOR: LARK®

FOR: LAS®

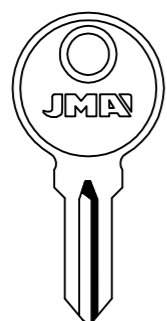

AX
001-224
LAS-AX

FOR: ATAL® - HEFELE® - KIFERM® - RENZ®

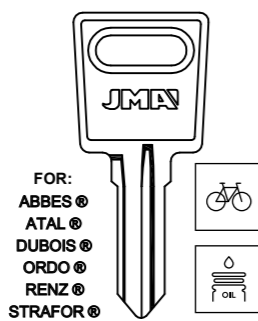

FM
LAS-2

FOR: LAS®

FOR: LAS®

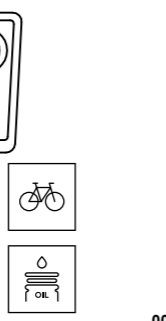

FH
001-400
501-550
LAS-3

H
LAS-5

U
LAS-U

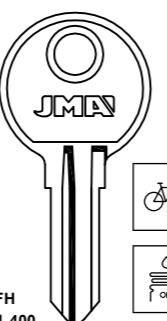

E
LAS-5D

X
LAS-X

FOR: KIFERM®

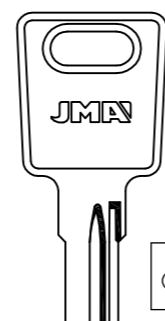

TA
LAS-6

RM
0001-2000
KT
3001-4000
LAS-KT

FOR: RONIS® - EURO LOCKS®
FOR: ATAL® - KIFERM® - MARCADET®



AT
LAS-6D

TK
4001-5000
LAS-TK

FOR: LAS®

FOR: LEGGE®



1 AL 7
LEG-1D

FOR: LEGGE®

FOR: LINCE®

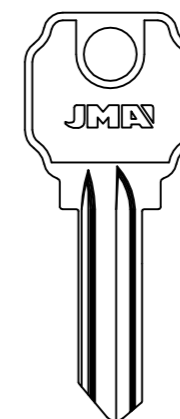

A
LIN-11

FOR: LINCE®

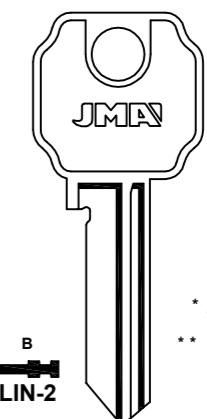

A
LIN-1D

FOR: LINCE®

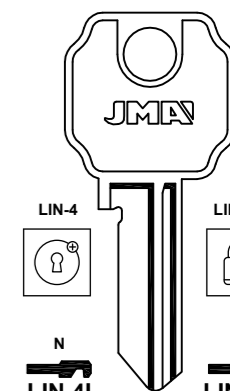

LIN-4

N
LIN-4I

LIN-14I

FOR: LINCE®

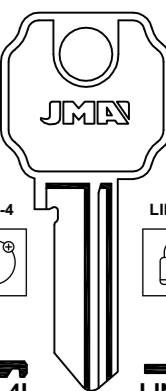

LIN-14

N
LIN-4D

LIN-14D

FOR: LINCE®

FOR: LAS®

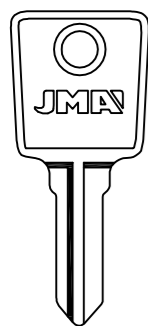

LAS-7

FOR: ABBES® - ORDO®

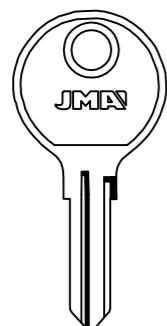

LS
LAS-8

L
LAS-9

* LAT.

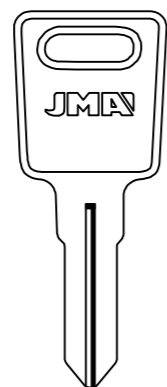

PR
LAS-10

FOR: MARCADET®

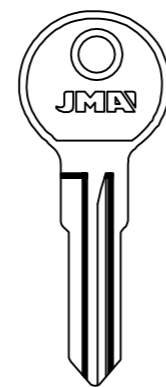

LAS-11

FOR: LAS®

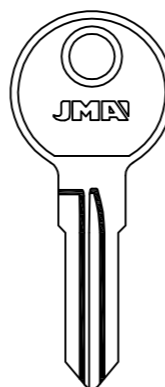

A...1-650
LAS-11D

FOR: ATAL® - KIFERM® - RENZ®

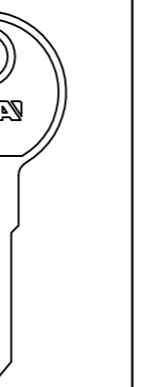

LAS-12D

FOR: LAS®

FOR: LINCE®

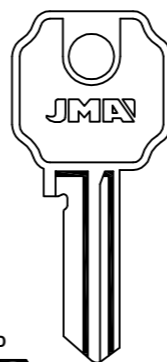

D
LIN-5I

T
LIN-12I

D1
LIN-18

FOR: LINCE®

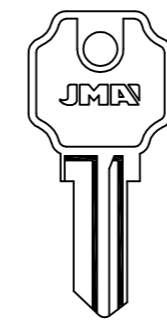

D
LIN-5D

T
LIN-12D

D1
LIN-18D

FOR: LINCE®

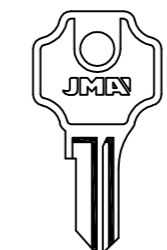

E
LIN-6I

FOR: LINCE®

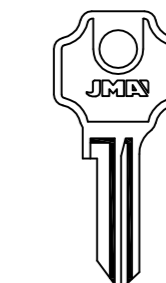

E
LIN-6D

FOR: LINCE®

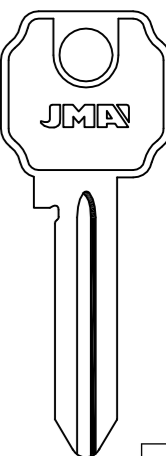

K
LIN-9

FOR: LINCE®

Concerning the marks and commercial denominations see legal warning.
Concerniente a las marcas y denominaciones comerciales ver aviso legal.
Marka eta izendapen komertzialiei dagokienez, ikus lege-oharra.
Concernant les marques et dénominations commerciales voir la note dans l'index.

JMA Opening the future

JMA Opening the future

Beziehen auf die Marke und Handelsname sehen Sie die Notiz im Impressum.
Relativamente às marcas e denominações comerciais, ver aviso legal.
Jeśli chodzi o znaki i nazwy handlowe, patrz Informacje prawne.

JMA Opening the future K01 / 69

FOR: LINCE®

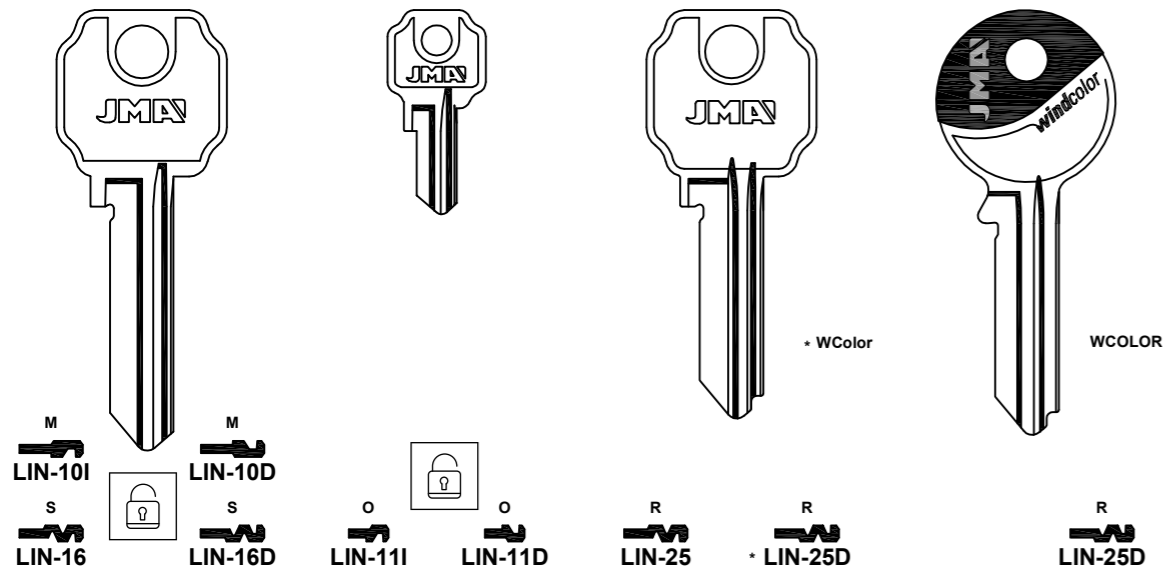

FOR: LIPS®

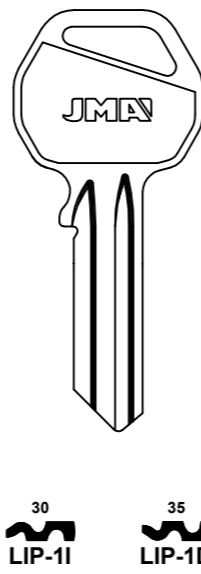

FOR: LOB®

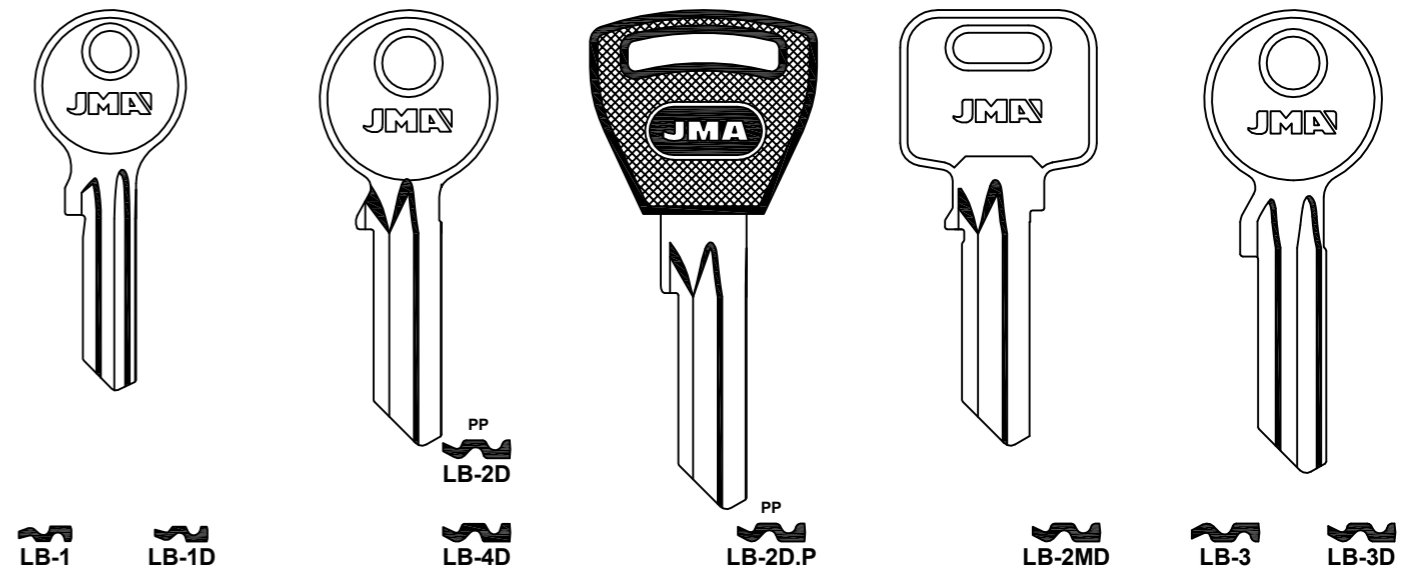

FOR: EXPRES®-PCO® FOR: BRICARD®-EXPRES®-REDY®-YETI® FOR: BRICARD®-EXPRES®-REDY®-YETI®

FOR: LIPS®

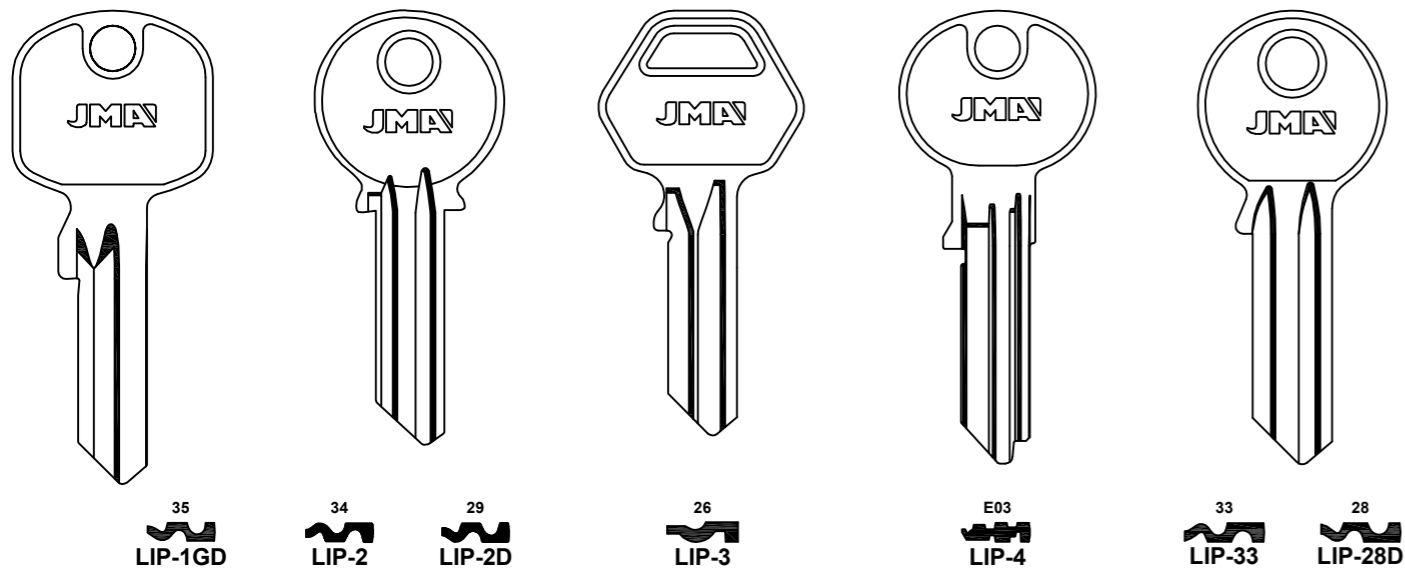

FOR: LOB®

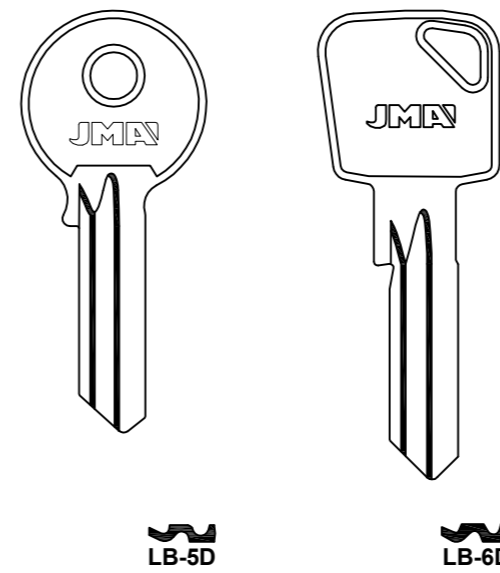

FOR: LOCK®

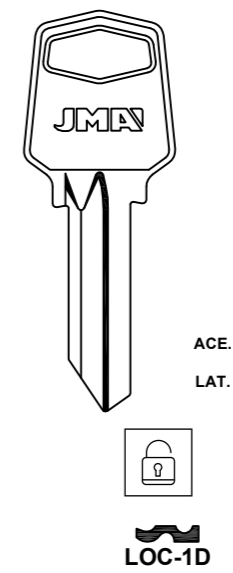

FOR: LOCKWOOD®

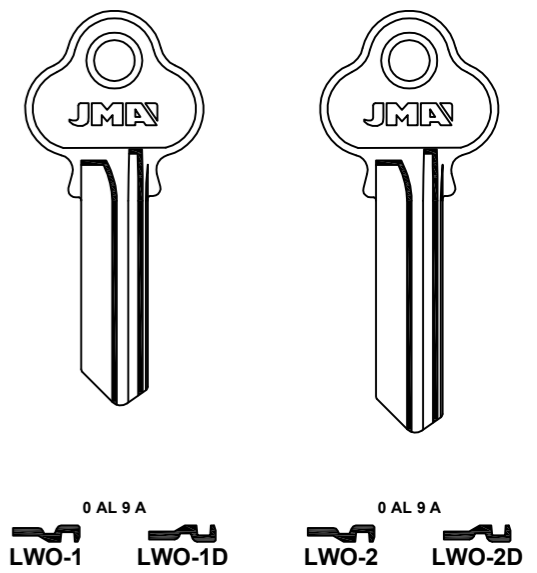

FOR: GAINSBOROUGH®

FOR: LITTO®

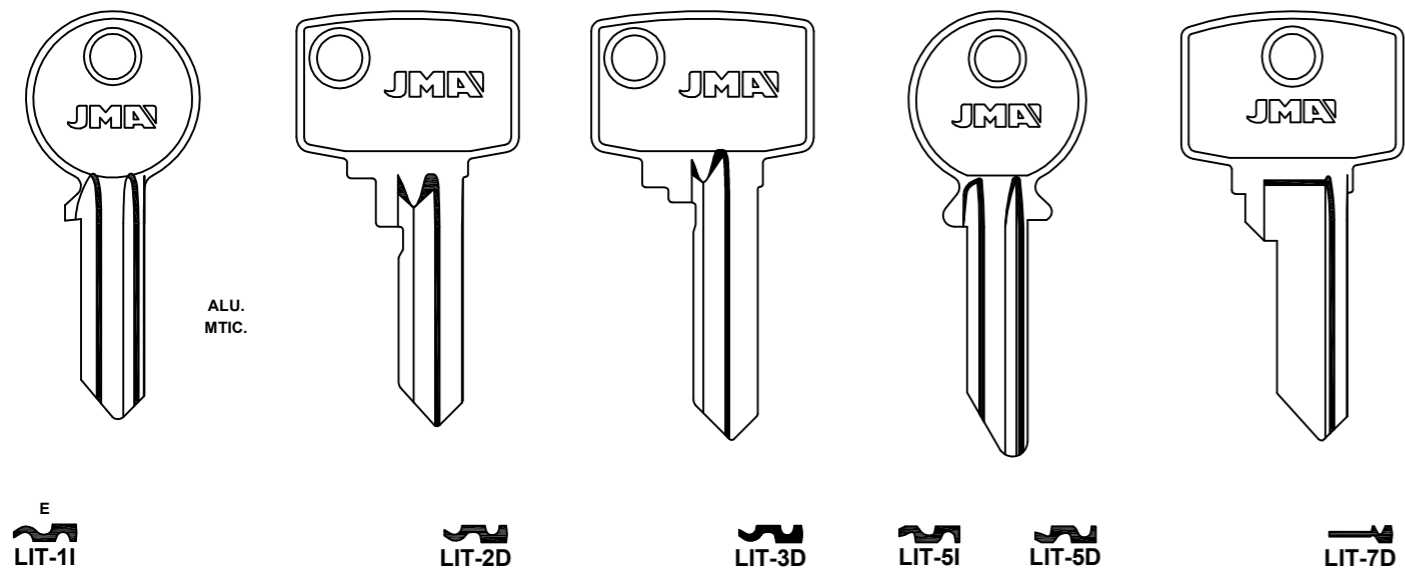

FOR: ANKERSLOT®

FOR: BKS®

FOR: LOCKWOOD®

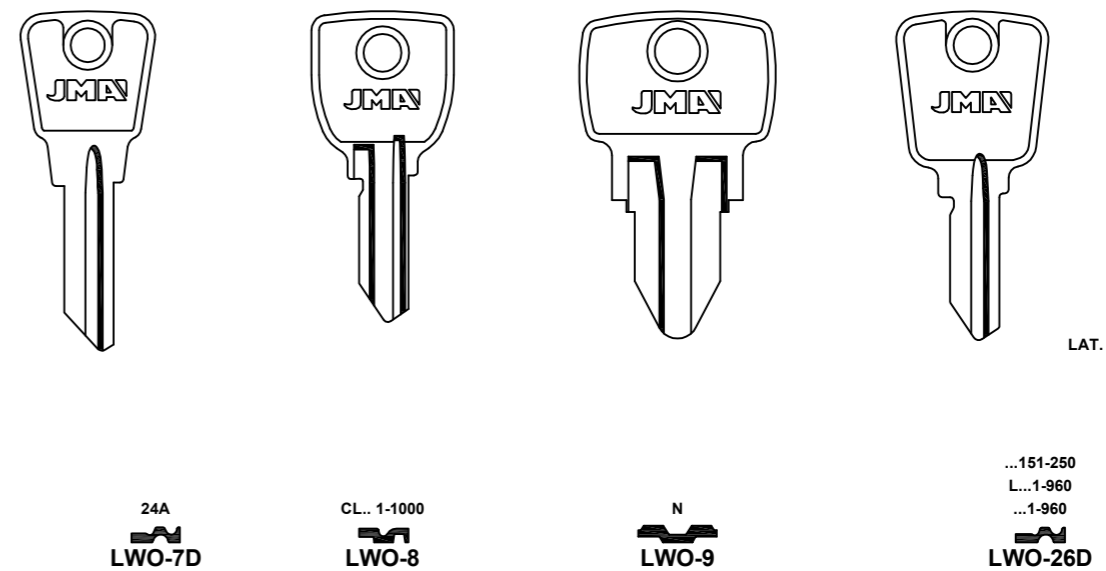

FOR: LEN®-LOK®

FOR: LEN®-LOK®

FOR: LOGO®

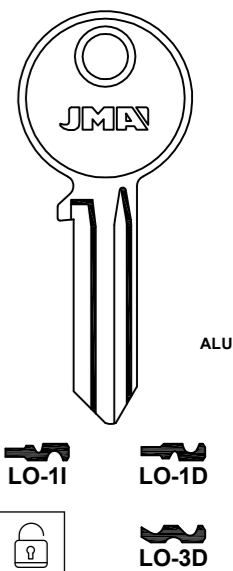

FOR: CISA®

Concerning the marks and commercial denominations see legal warning.
 Concerniente a las marcas y denominaciones comerciales ver aviso legal.
 Marka eta izendapen komertzialiei dagokienez, ikus lege-oharra.
 Concernant les marques et dénominations commerciales voir la note dans l'index.

JMA Opening the future

JMA Opening the future

Beziehen auf die Marke und Handelsname sehen Sie die Notiz im Impressum.
 Relativamente às marcas e denominações comerciais, ver aviso legal.
 Jeśli chodzi o znaki i nazwy handlowe, patrz Informacje prawne.

K01 / 71

FOR: LOGO ®

FOR: LOWE & FLETCHER ®

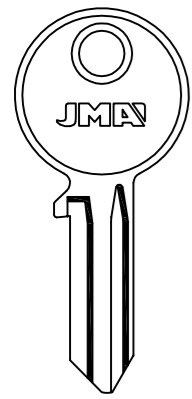

LO-21 LO-2D



FOR: CISA ®

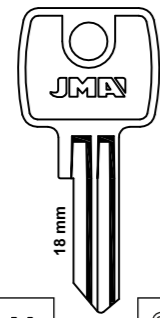

90...1-200
...1-400
91...201-275
GH...1-4000
SS...1-400
91...276-350



LF-11 LF-1D

FOR: CEM ® -EURO LOCKS ® -UNION ®

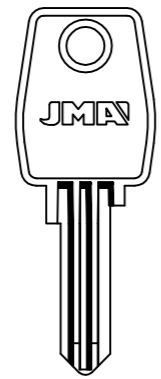

95001-97000
97001-99000



LF-2



LF-12 LF-12D

FOR: DOBLE SAFE ® -EURO LOCKS ®

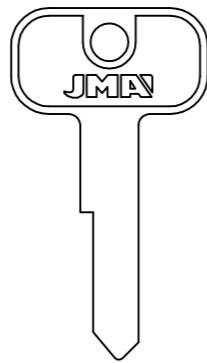

RL-RM
801-952



LF-3

FOR: STREBOR ®

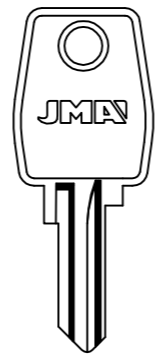

LF-41

FOR: EURO LOCKS ®

FOR: LOWE & FLETCHER ®

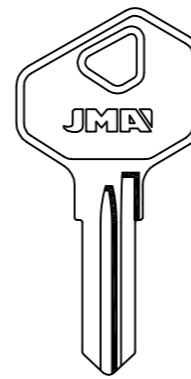

19...1-420
...17001-19000
...7001-9000



LF-20

FOR: B&D ® -BRIGGS & STRATTON ®

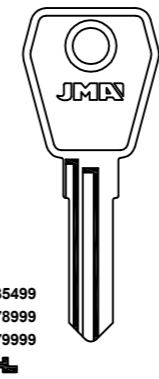

...35000-35499
...78000-78999
...79000-79999



LF-21



LF-33D

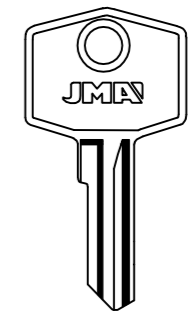

LF-23

FOR: ULTRA ®

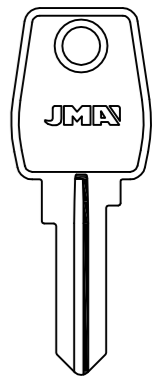

LF-24

FOR: DOBLE SAFE ® -EURO LOCKS ®

FOR: LOWE & FLETCHER ®

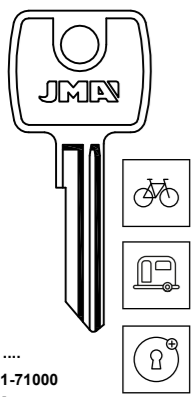

70001-71000
M...
70001-71000

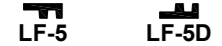

LF-5 LF-5D

FOR: TELFORD ®

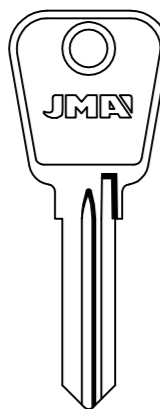

66001-67200 81001-87000



LF-7 LF-7D

FOR: FORD EUROPA ®

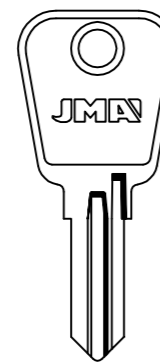

93...201-400
...93901-94000



LF-8 LF-8D

FOR: EURO LOCKS ® -MIBRA ® -UTZ ®

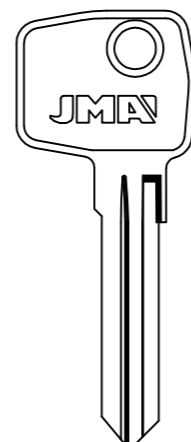

93...201-400
...93901-94000



LF-13 LF-13D

FOR: MIBRA ® -UTZ ®

FOR: LOWE & FLETCHER ®

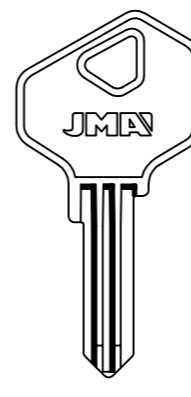

V..1-88



LF-25

14001-14088



LF-40

FOR: EURO LOCKS ®

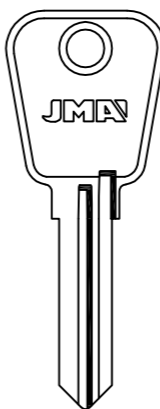

LF-26

FOR: EURO LOCKS ®

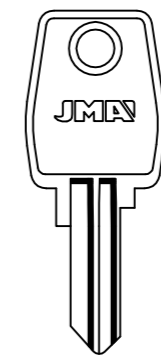

LF-27

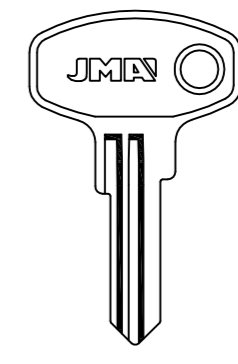

LF-28

FOR: EURO LOCKS ®

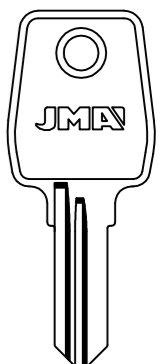

93...401-900
...90901-90975



LF-29D

FOR: EURO LOCKS ®

FOR: LOWE & FLETCHER ®

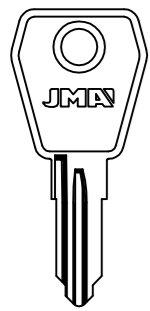

LF-14D

FOR: EURO LOCKS ®

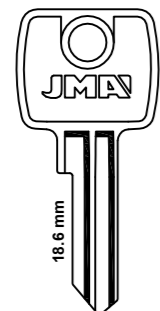

LF-15

FFE

001-100



LF-17

FOR: CEM ® -EURO LOCKS ® -ULTRA ® -UNION ®



60... 001-200
60... 001-200
90... 001-200
...1-400
GHM...1-155
M...1-400
RV...1-400
RVM...1-400
SP...1-400
99...1-400



LF-15D

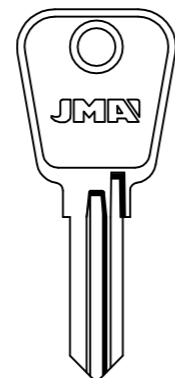

LF-16

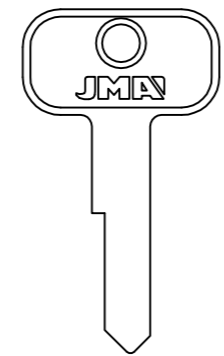

LF-18D

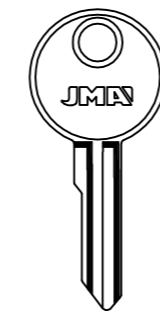

LF-19

FOR: LOWE & FLETCHER ®

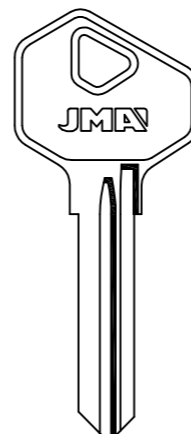

09...1-900
29...1-478



LF-30

FOR: EURO LOCKS ®

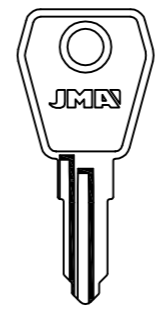

LF-31

FOR: EURO LOCKS ®

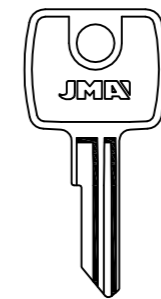

LF-34

FOR: EURO LOCKS ®

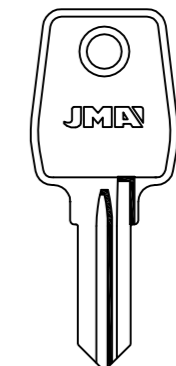

R...201-600
...9001-9494



LF-35

FOR: EURO LOCKS ®

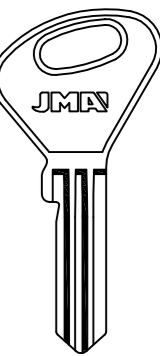

LF-36

FOR: EURO LOCKS ®

Concerning the marks and commercial denominations see legal warning.
Concarniente a las marcas y denominaciones comerciales ver aviso legal.
Marka eta izendapen komertzialiei dagokienez, ikus lege-oharra.
Concernant les marques et denominations commerciales voir la note dans l'index.

FOR: LOWE & FLETCHER®

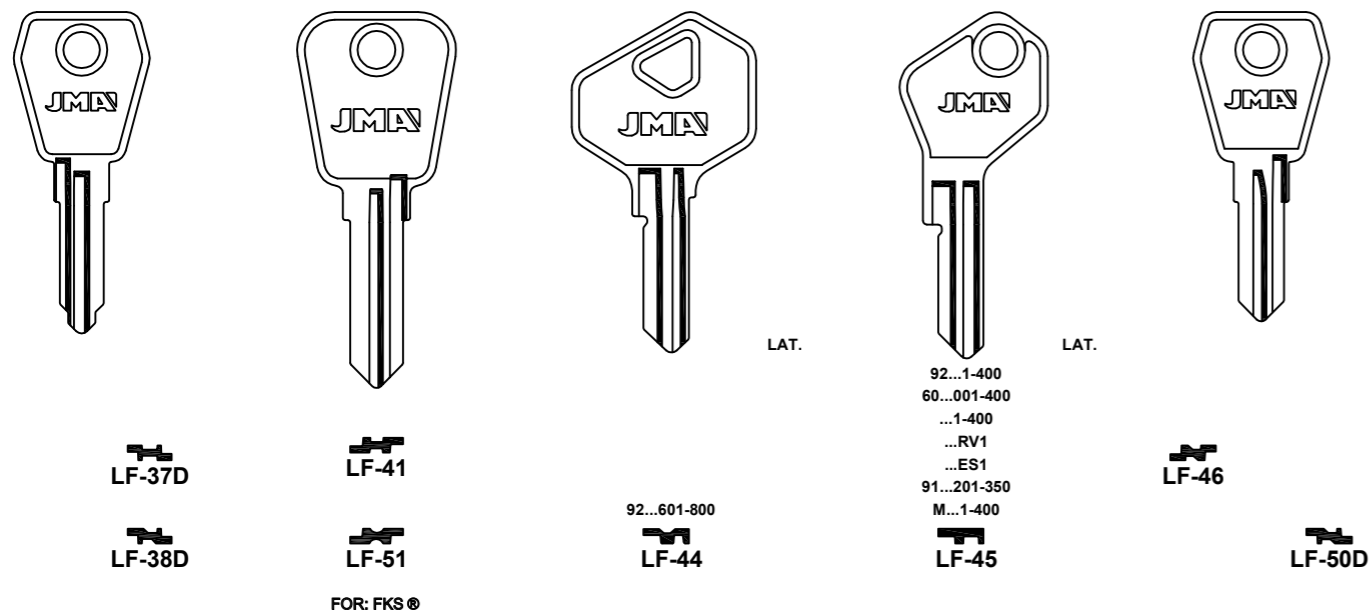

FOR: MASTER®

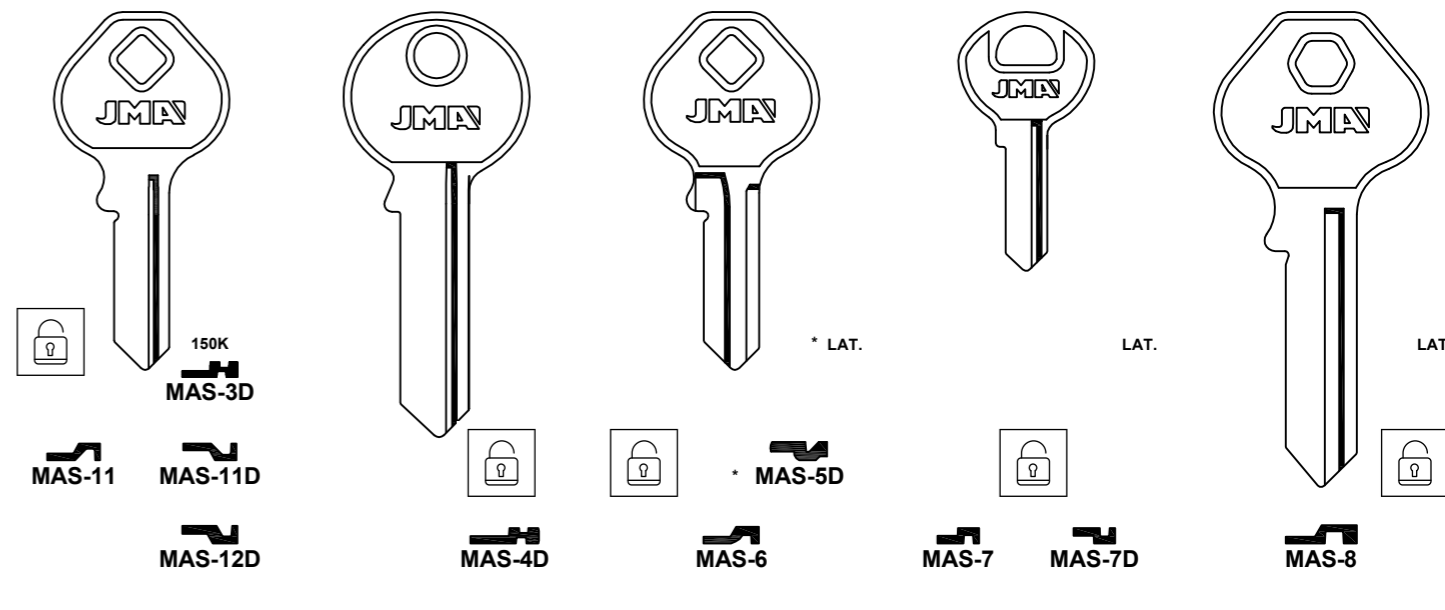

FOR: LUCKY®

FOR: LUMA®

FOR: MARIANI®

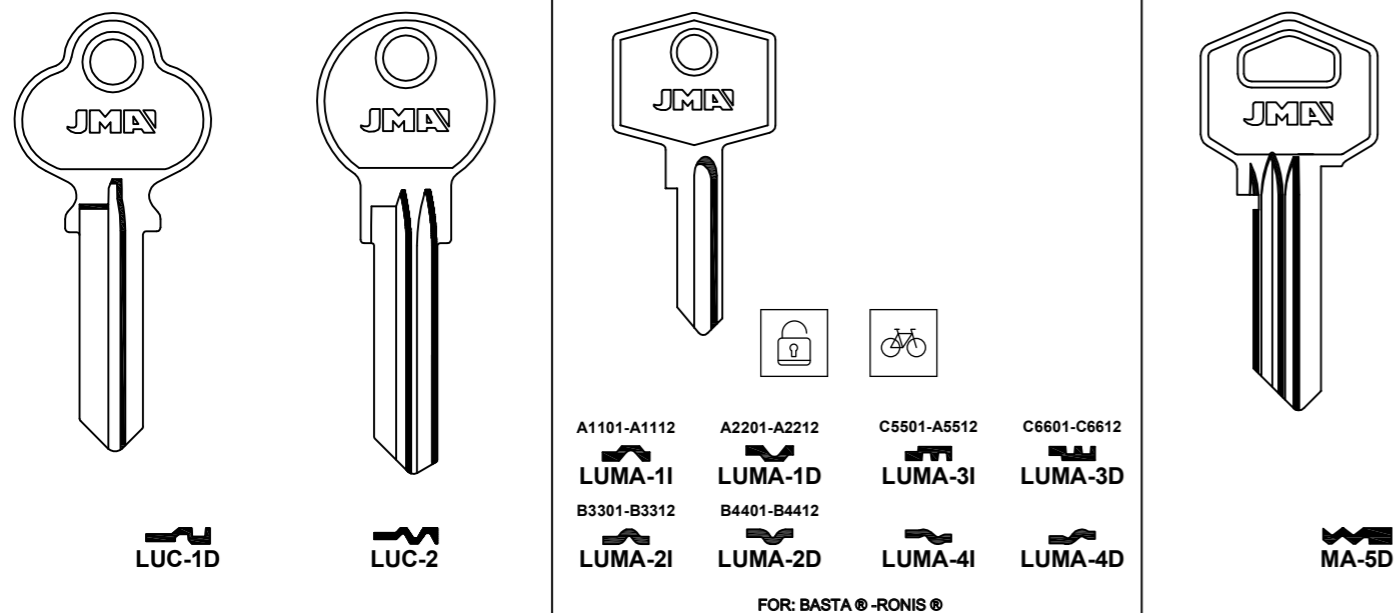

FOR: MASTER®

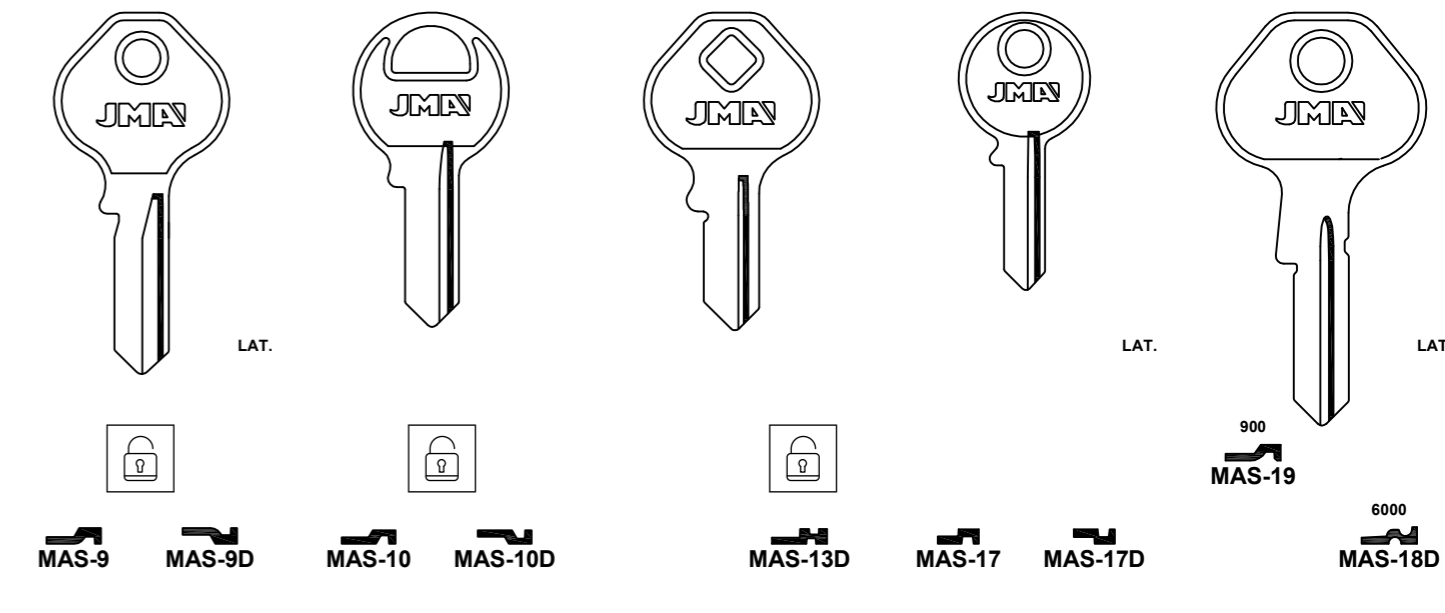

FOR: MARQUES®

FOR: MASTER®

FOR: MASTER®

FOR: MAUER®

FOR: MAXUS®

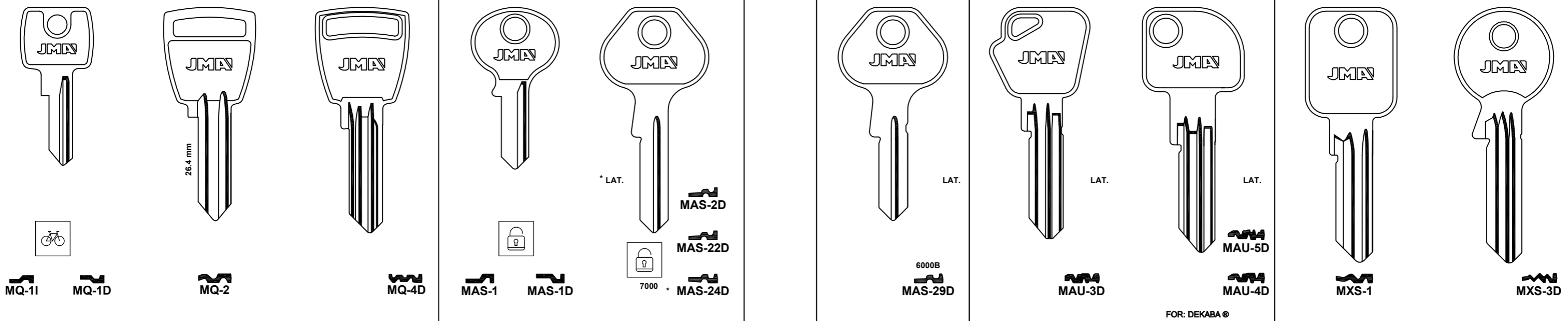

Concerning the marks and commercial denominations see legal warning.
 Concerniente a las marcas y denominaciones comerciales ver aviso legal.
 Marka eta izendapen komertzialiei dagokienez, ikus lege-oharra.
 Concernant les marques et denominations commerciales voir la note dans l'index.

JMA® Opening the future

JMA® Opening the future

Beziehen auf die marke und handelsname sehen sie die notiz im Impressum.
 Relativamente às marcas e denominações comerciais, ver aviso legal.
 Jeśli chodzi o znaki i nazwy handlowe, patrz Informacje prawne.

FOR: MCL®

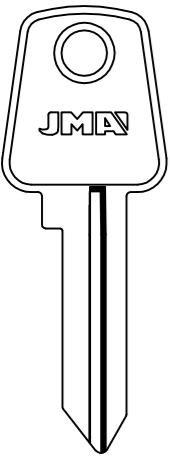

MCL-1D

FOR: MCM®

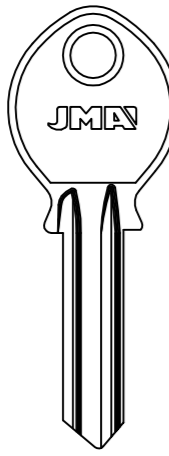

MCM-1

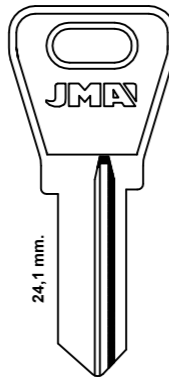

24,1 mm.
MCM-2I



MCM-2D

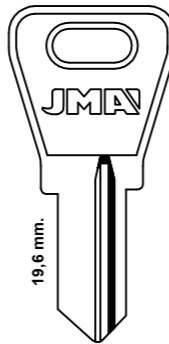

19,6 mm.
MCM-3I



MCM-3D

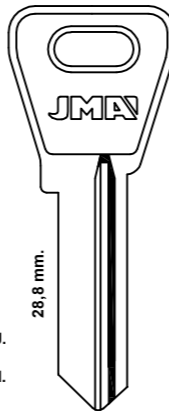

28,8 mm.
* ALU.
* FSH.
MCM-4I



MCM-4D



MCM-4EC

FOR: ESAFE®-K+K®

FOR: MCM®

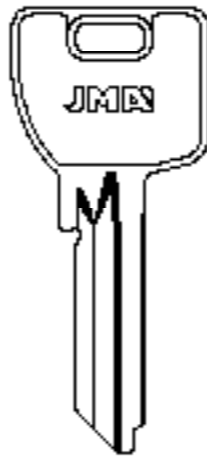

MCM-30D

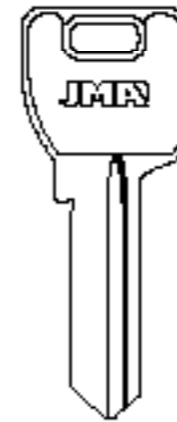

MCM-31

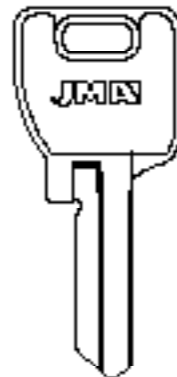

MCM-31D



MCM-32D

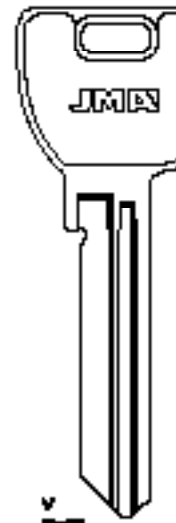

MCM-33



MCM-35

FOR: MCM®

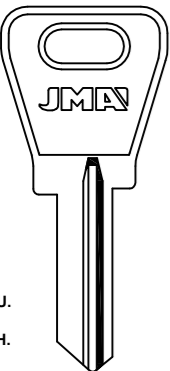

* ALU.
* FSH.
MCM-5I



MCM-5D

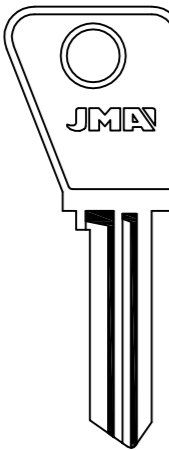

MCM-6

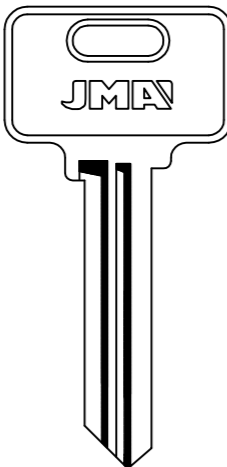

MCM-7

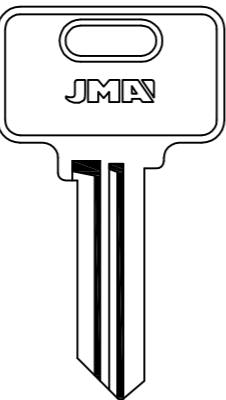

MCM-8

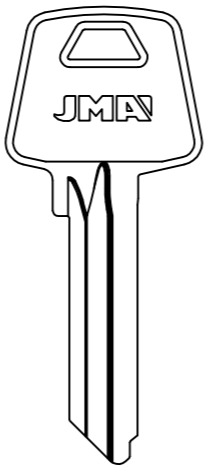

MCM-12D

FOR: COFER®

FOR: ME-FA®

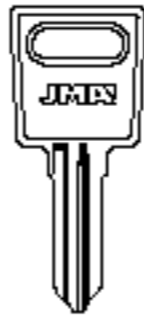

ME-FA-1

FOR: MECO®

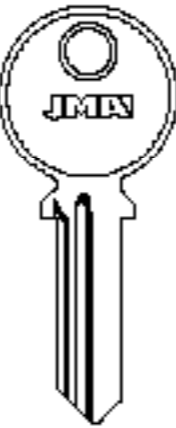

MECO-5D

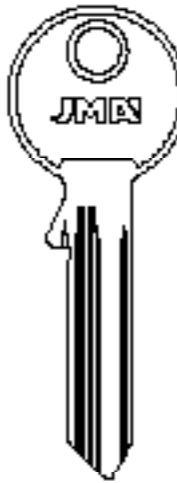

MECO-6

FOR: MEDOS®

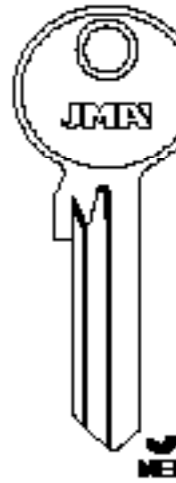

MEDOS-2D



MEDOS-1D

FOR: MELSMETALL®



MEL-1



MEL-4



MEL-4D

FOR: MCM®

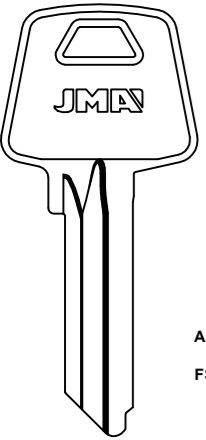

MCM-13D

ALU.
FSH.

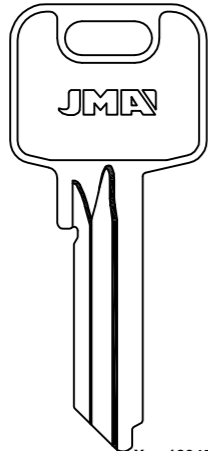

X.....1234567890
E.....11241-79868
E-1
MCM-18D



MCM-24B



MCM-24C



MCM-24D



MCM-24E



MCM-24F



MCM-26

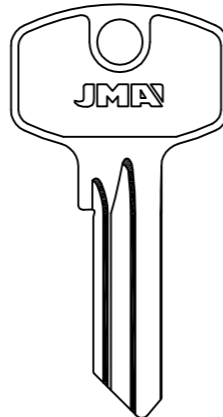

MCM-29D

FOR: HEGEL®

FOR: MELSMETALL®



MEL-2I



MEL-3

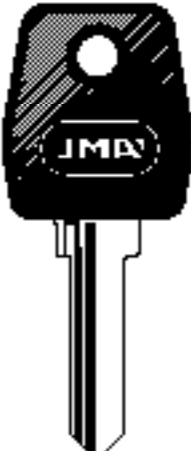

MEL-SP

FOR: MERONI®

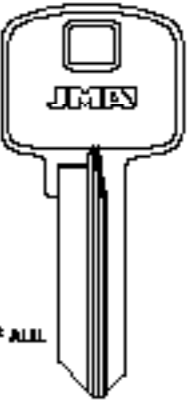

* ALL
Y
O A L B
M
O A L B
* **MER-1D**



MER-2I



MER-3I

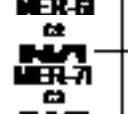

MER-4I



MER-5I



MER-6I

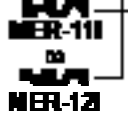

MER-7I

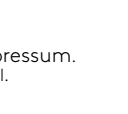

MER-8I



MER-9I



MER-10I

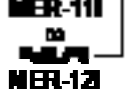

MER-11I

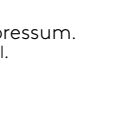

MER-12I



MER-13I



MER-14I

Concerning the marks and commercial denominations see legal warning.
 Concerniente a las marcas y denominaciones comerciales ver aviso legal.
 Marka eta izendapen komertzialiei dagokienez, ikus lege-oharra.
 Concernant les marques et dénominations commerciales voir la note dans l'index.

JMA® Opening the future

JMA® Opening the future

Beziehen auf die Marke und Handelsname sehen Sie die Notiz im Impressum.
 Relativamente às marcas e denominações comerciais, ver aviso legal.
 Jeśli chodzi o znaki i nazwy handlowe, patrz Informacje prawne.

FOR: MERONI ®

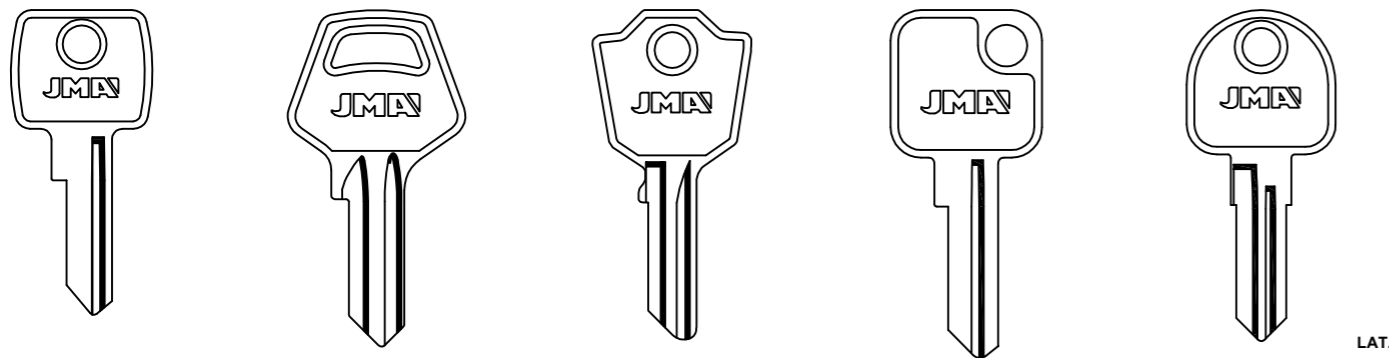

LAT.

MER-15 1001-1500
MER-16 MER-16D
MER-17 G...3001-3480
MER-18 G...0-480
MER-19D ...3001-3480

FOR: LAMA ®

FOR: LAMA ®

FOR: PREMI ® -APRI ®

FOR: MILA ®

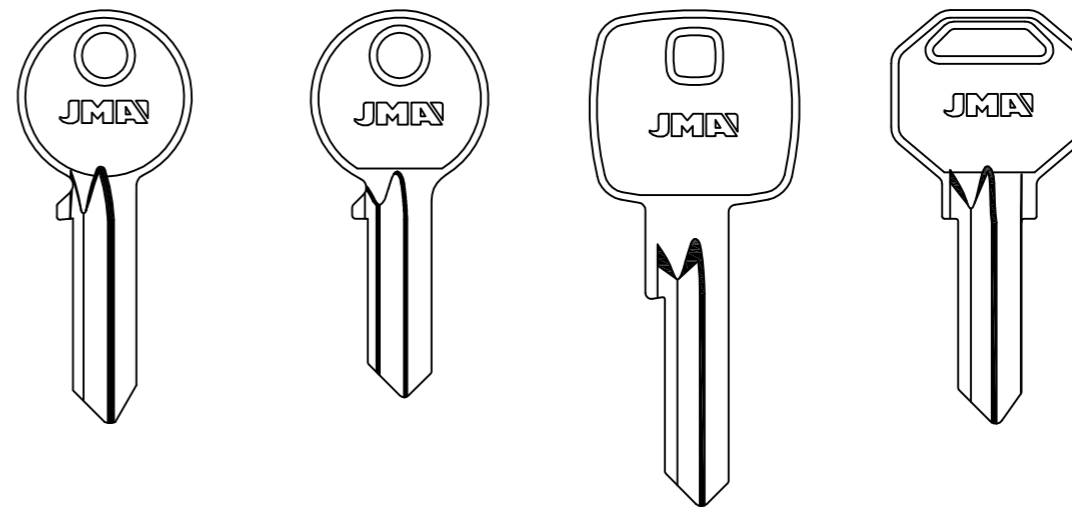

MI-2D MI-3D MI-4D MI-5D

FOR: TRINITY ®

FOR: MILES ®

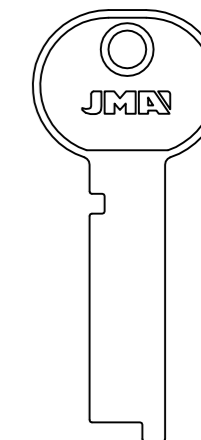

MIL-1

FOR: MI

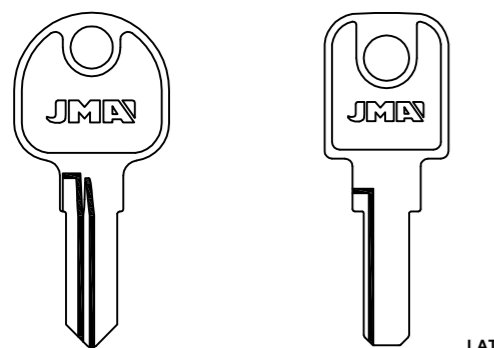

LAT.

CC
MER-20D
CD
MER-21D

MER-22D

FOR: METAL ®

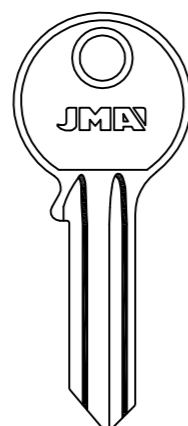

MTL-1 MTL-1D

FOR: METALUX ®

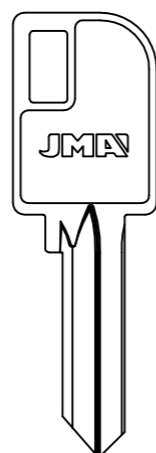

MET-2D

FOR: CAS ® -CISMA ®

FOR: METEOR ®

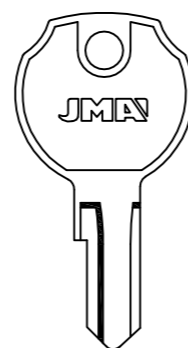

B...1-600
G...1-600
MTO-1

FOR: MILES ®

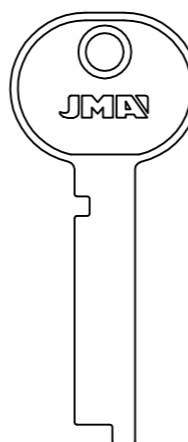

MIL-2

FOR: MING-TAY ®

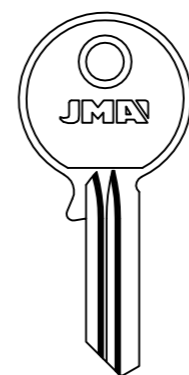

MIN-1D

FOR: MISCELLANEOUS ®

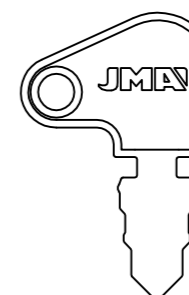

MIS-1

FOR: MIWA ®

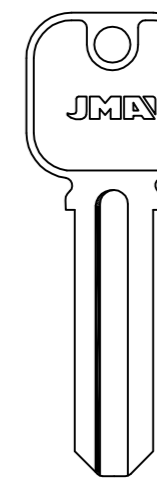

MIW-1

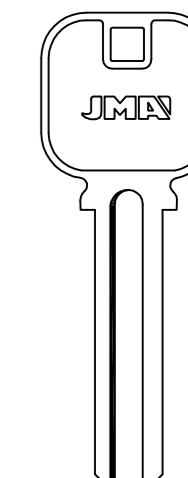

MIW-2

FOR: METIZ ®

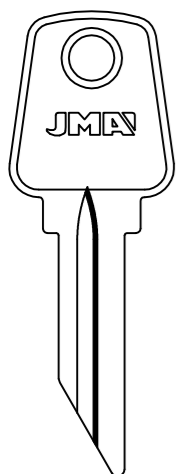

MEZ-1D

FOR: MG (MONTI) ®

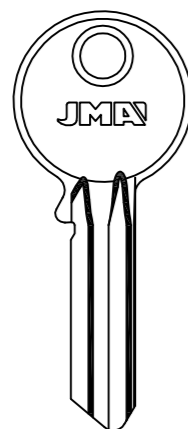

MGA-1 MGA-1D

FOR: MICHEL-SEAT ®

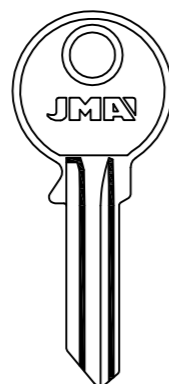

MCH-1 MCH-1D

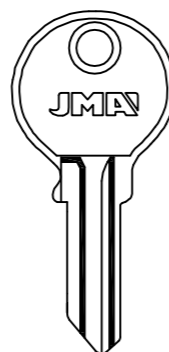

MCH-2 MCH-2D

FOR: OMR ® -POTENT ®

FOR: AM ® -POTENT ®

FOR: MILA ®

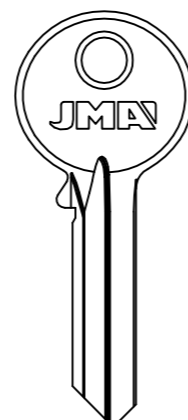

MI-1D

FOR: MIWA ®

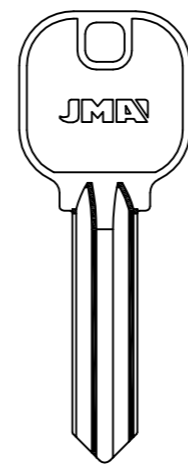

1-2-3-4
1-2-3-4-5
MIW-3

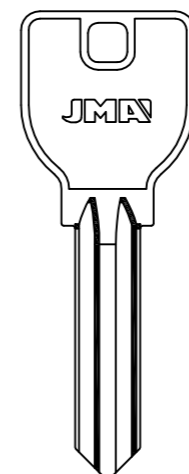

1-2-3-4
1-2-3-4-5
MIW-4

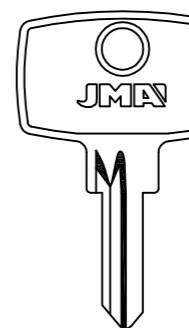

L...1-101
L...1-222
MLM-1D

FOR: MLM ®

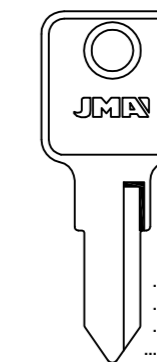

....4001-4100
....5000-5100
....7001-7499
....18001-18100
MLM-2 MLM-5D
MLM-5 MLM-9

FOR: DOM ® -LEHMANN ® -ORDO ® -STUV ®

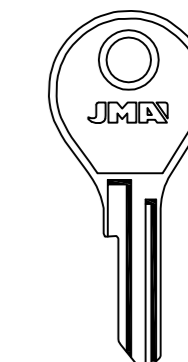

MLM-3

Concerning the marks and commercial denominations see legal warning.
Concerniente a las marcas y denominaciones comerciales ver aviso legal.
Marka eta izendapen komertzialiei dagokienez, ikus lege-oharra.
Concernant les marques et denominations commerciales voir la note dans l'index.

JMA Opening the future

JMA Opening the future

Beziehen auf die Marke und Handelsname sehen Sie die Notiz im Impressum.
Relativamente às marcas e denominações comerciais, ver aviso legal.
Jeśli chodzi o znaki i nazwy handlowe, patrz Informacje prawne.

K01 / 79

FOR: MLM® MLM-6 MLM-7	FOR: MOBELLA® MBL-1 MBL-1D	FOR: MOGILEV® MOG-1D	FOR: MON® MON-11 MON-1D MON-21 MON-2D	
-------------------------------------	--	-----------------------------	---	--

FOR: MSV® MSV-1 MSV-2	FOR: MULT.LOCK® MU-6 MU-6D	FOR: NATIONAL CABINET® NTC-6 NTC-10D	FOR: NEMEF® NEF-4 NEF-3
-------------------------------------	--	--	---------------------------------------

FOR: MONOBLOC® MNO-1D FOR: FO®	FOR: MOSRENTGUEN® MR-1 MR-2 MR-3		
--	---	--	--

FOR: NOVA® NO-1 FOR: ABUS® -TOP®	FOR: NOXXA® NOX-1	FOR: OCARIZ® OCA-1D OCA-2D	FOR: OCTAVO M.® 8M-1D	FOR: OFITA® OF-1
--	--------------------------	--	------------------------------	-------------------------

FOR: MOTTURA® MT-AG MT-CG MT-EG MT-GG LAT. MT-AG.P MT-CG.P MT-EG.P MT-DG.P LAT. MT-GG.P		FOR: M.P. PLODARI® MP-11 MP-1D	FOR: MSM® MSM-2D
--	--	--	-------------------------

FOR: OFITA® OF-2	FOR: OJMAR® OJ-1D OJ-21 OJ-31 OJ-3D OJ-71 OJ-4D			
-------------------------	---	--	--	--

Concerning the marks and commercial denominations see legal warning.
 Concerniente a las marcas y denominaciones comerciales ver aviso legal.
 Marka eta izendapen komertzialiei dagokienez, ikus lege-oharra.
 Concernant les marques et dénominations commerciales voir la note dans l'index.

FOR: OJMAR®

OJ-5I OJ-6I OJ-6D OJ-J OJ-K OJ-L OJ-M OJ-9D

FOR: HERO® -KEMEN® -RS®

FOR: OJMAR®

OJ-10 OJ-11 OJ-12 OJ-13 OJ-14 OJ-15 OJ-16 OJ-17 OJ-18.P OJ-19

FOR: BURG® -HRG® -ISKU® -KEMEN® -MOFLEX® -SISO® -STUMPF METALL® FOR: BURG®

FOR: OJMAR® FOR: OLIVA® FOR: OLIVETTI® FOR: OMA® FOR: OMEC®

OJ-21D OL-5D OLIV-1 OA-1 OMC-1D

FOR: FERMABLOCK® -PB® -PREFER® FOR: C.A.R.S.®

FOR: OMEC® FOR: OMIV® FOR: O.M.R.®

OMC-2D OMC-5D OMC-6D OMI-1 OMI-1D OM-1

FOR: CIB® -STV® FOR: MICHEL SEAT®

FOR: ORDO® FOR: ORION-NOVOX® FOR: ORO® FOR: ORSHA® FOR: PADO®

OR-1I ON-1I ON-1D ORO-1D ORK-1D PAD-1D

FOR: DECAYEUX®

FOR: PADO® FOR: PAPAIZ®

PAD-2D PAD-3 PAD-3D PAP-1 PAP-2 PAP-3

Concerning the marks and commercial denominations see legal warning.
 Concerniente a las marcas y denominaciones comerciales ver aviso legal.
 Marka eta izendapen komertzialiei dagokienez, ikus lege-oharra.
 Concernant les marques et dénominations commerciales voir la note dans l'index.

FOR: PAPAIZ®

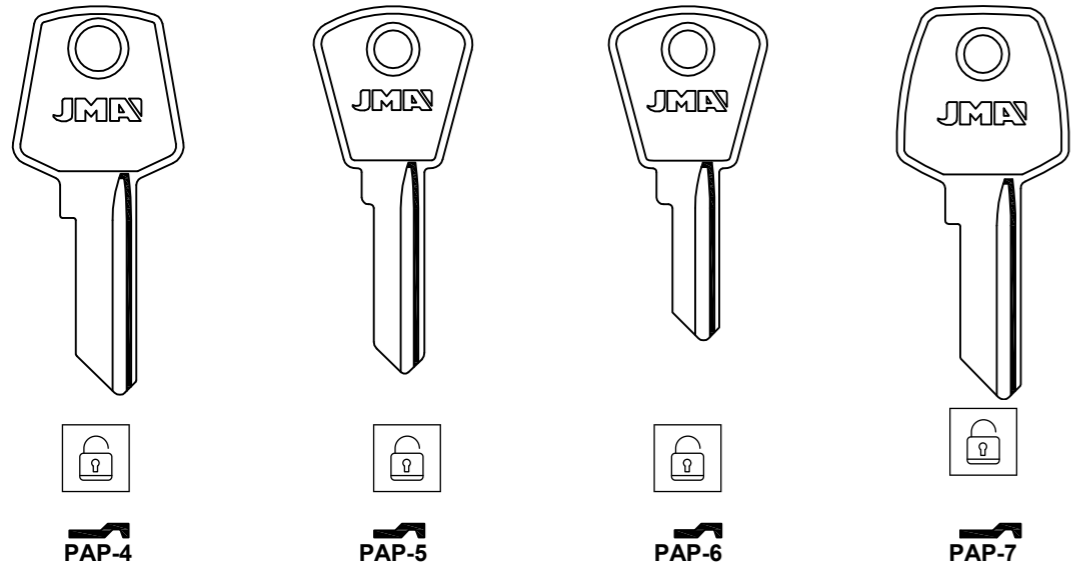

FOR: P.C.®

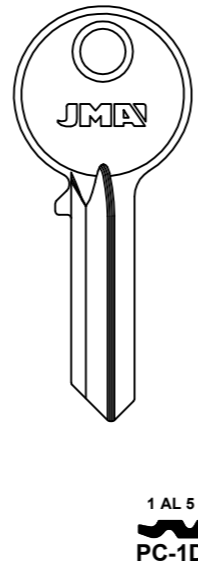

FOR: ETNA® - FEB® - FPB® - FRAL® - SANTOS®

FOR: PFAFFENHAIN®

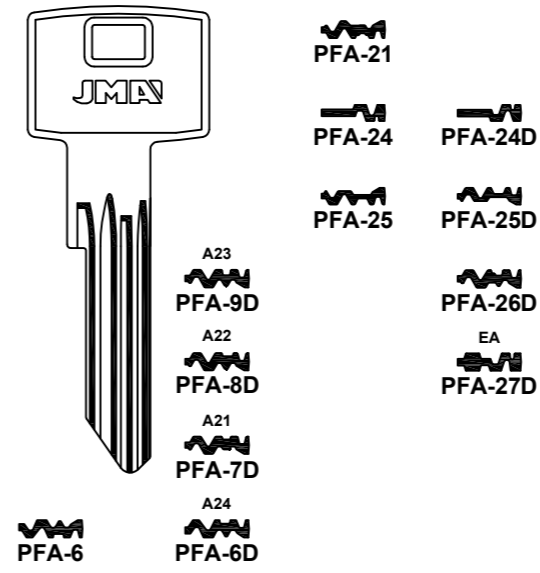

FOR: PHILLIPS®

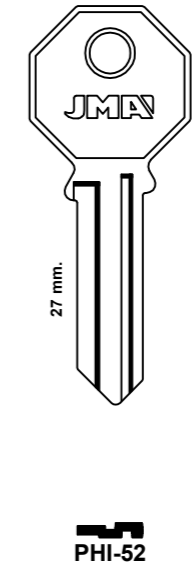

FOR: PHOENIX®

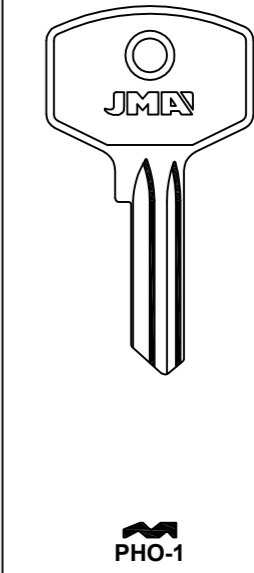

FOR: POLLUX®

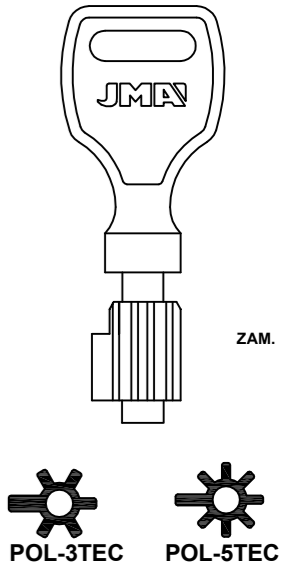

FOR: P.C.®

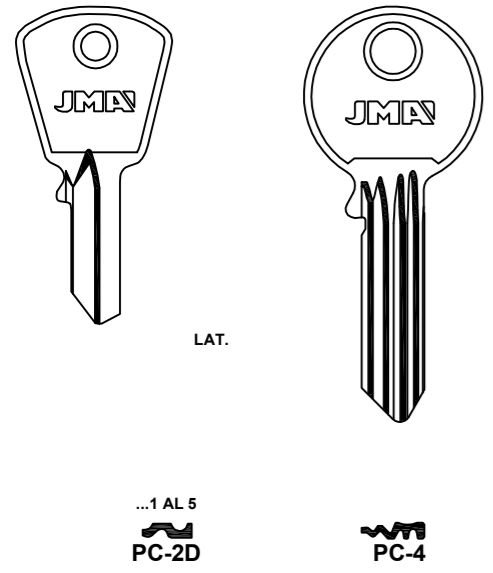

FOR: PENZMASH®

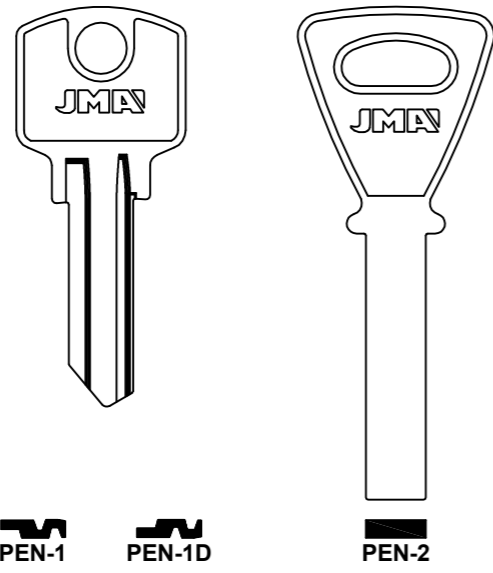

FOR: PETROZAVODSK®

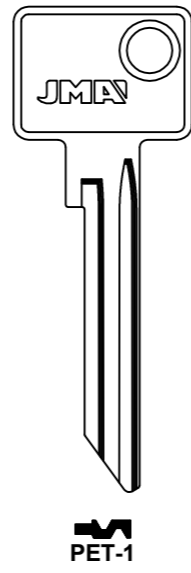

FOR: POLLUX®

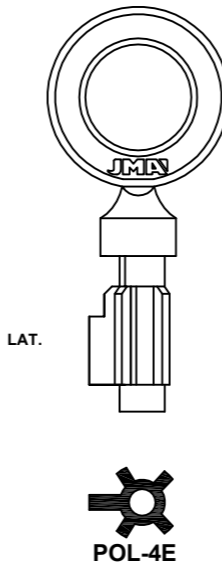

FOR: PREFER®

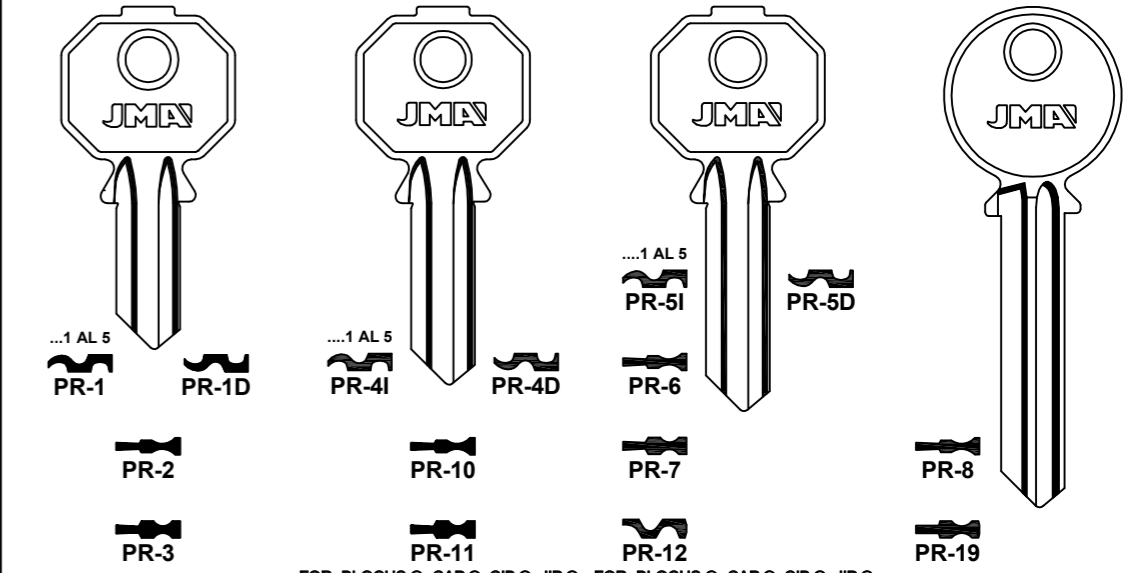

FOR: PFAFFENHAIN®

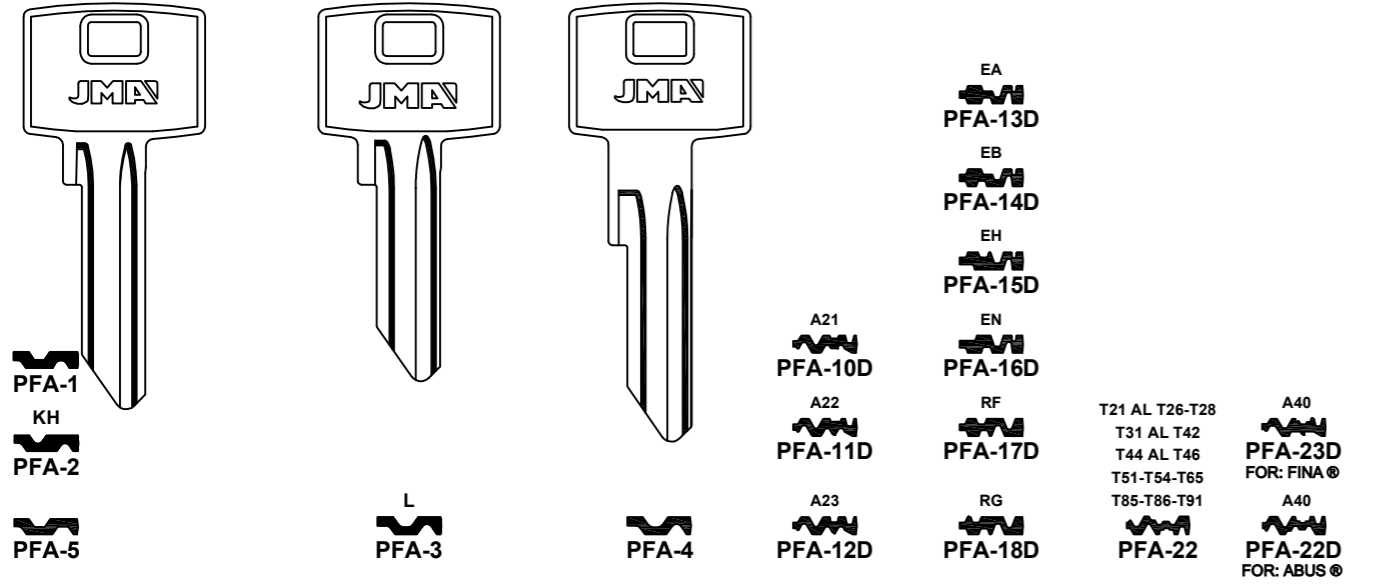

FOR: PREFER®

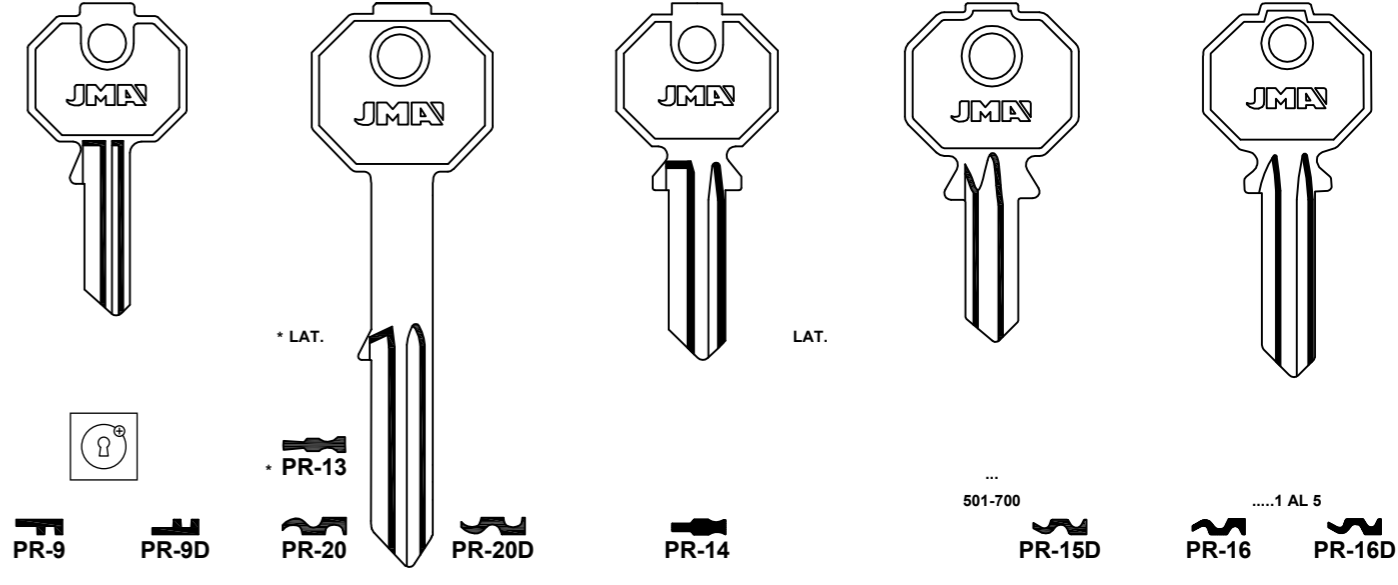

Concerning the marks and commercial denominations see legal warning.
 Concerniente a las marcas y denominaciones comerciales ver aviso legal.
 Marka eta izendapen komertzialiei dagokienez, ikus lege-oharra.
 Concernant les marques et denominations commerciales voir la note dans l'index.



Beziehen auf die marke und handelsname sehen sie die notiz im Impressum.
 Relativamente às marcas e denominações comerciais, ver aviso legal.
 Jeśli chodzi o znaki i nazwy handlowe, patrz Informacje prawne.

FOR: PREFER®		FOR: REGAL®		FOR: RENZ®	
.....1 AL 5 PR-17D	LAT. PR-18	REG-1D	RE-1	RE-1D	RE-2 RE-2D RE-4D
FOR: IMBAC®		FOR: ARFE®		32...001-200	
FOR: RENZ®		FOR: REX®		FOR: RGM®	
RE-3D	RE-5 RE-5D	RE-6	RE-6D	REX-1D	RGM-1I RGM-1D
FOR: EURO LOCKS®		FOR: REX®		FOR: RGM®	
FOR: RGM®		FOR: RIAZIAN®		FOR: RICOUARD®	
RGM-2	RAZ-1D	RIO-1D	RIG-1D	RIG-1D	26-M
FOR: RGM®		FOR: RIAZIAN®		FOR: RICOUARD®	

FOR: RIPA®		FOR: RITA®		FOR: RODES®		FOR: RONIS®	
RI-1I RI-2I RI-3I	RI-1D RI-2D RI-3D	RIT-1D	ROD-1 ROD-1D	RO-1I RO-1D	RO-6I RO-6D	..4AB-ZZ S...331-348 RO-2I	..3AB-ZZ1 AL 4 RO-2D AA-JZ A3..JA.3. S...213-246 RO-4I RO-4D AB-ZZ ..6 S...349-366 RO-6I RO-6D
FOR: ABUS® -FADE®		FOR: RODES®		FOR: RONIS®		FOR: CITROEN® -PEUGEOT® -RENAULT® -TALBOT® FOR: ABSA® -FROSER® -PJ® -SADV®	
FOR: RIPA®		FOR: RITA®		FOR: RODES®		FOR: RONIS®	
C4..AA-ZY D4..AA-HR RO-5I	C3..AA-ZY D3..AA-HR J...1-544 RO-5D	...151-700 E...1-1000 T...107-400 Y...101-600 RO-7I	...11 1-700 A...A1-700 C...101-600 D...1-1000 T...1-380 TA...1-224 GV...1-300 ...F1-500 1F..1-21 RO-7D	...151-700 E...1-1000 T...107-400 Y...101-600 RO-30I RO-30D	...151-700 E...1-1000 T...107-400 Y...101-600 RO-8I RO-8D F...1-500 RO-30I RO-30D	...151-700 E...1-1000 T...107-400 Y...101-600 RO-9I RO-9D	FOR: ARMOR® EMHART® FORINDEX® KARDEX® MLM® NEMEF® RONEO® SANEL STRAFOR® SCHAFFER® YAC® T...1-380 TA...1-224 GV...1-300 ...F1-500 1F..1-21 RO-8I RO-8D F...1-500 RO-30I RO-30D FOR: ANTAR® GIMN® JIP® LAPERCHE® PM® SESA® ...0 AL 8 RO-9I RO-9D
FOR: CITROEN® -PEUGEOT® FOR: ABSA®		FOR: ALFA ROMEO® -RENAULT®		FOR: RONIS®		FOR: RONIS®	
FOR: RIPA®		FOR: RITA®		FOR: RODES®		FOR: RONIS®	
RO-10I RO-10D	RO-22I	RO-23D	FM RO-18I FOR: LIONA LIOX® -LAPERCHE® FL RO-19I RO-19D FOR: LAPERCHE® FK RO-20I RO-20D FOR: FONTAINE® -LAPERCHE® ET RO-21I RO-21D RO-22I	RO-10D ANTAR® BLOCUS® BAB® DEBEAURAIN® DELTA® DERLOCHE® DESPREZ® DC® EMGE® EQUIBATIR® FONTAINE® FORINDEX® GOLLOT® GUIDOTTI® JIP® LAPERCHE® LIONA-LIOX® MAFOR® MONDIAL® MOREAUX® NUMIDIA® PM® SESA® STREMLER® STUV® VEGA®	...11 1-700 A...A1-700 C...101-600 D...1-1000 T...1-380 TA...1-224 GV...1-300 ...F1-500 1F..1-21 RO-11I RO-11D FOR: PEUGEOT® -RENAULT® FOR: ABSA® -SADV® -SIMPLEX®	...11 1-700 A...A1-700 C...101-600 D...1-1000 T...1-380 TA...1-224 GV...1-300 ...F1-500 1F..1-21 RO-12I RO-12D M...601-983 TAV RO-16I RO-16D FOR: BURG® -STRAFOR®	
FOR: RIPA®		FOR: RITA®		FOR: RODES®		FOR: RONIS®	











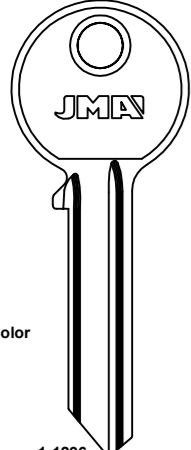

Concerning the marks and commercial denominations see legal warning.
 Concerniente a las marcas y denominaciones comerciales ver aviso legal.
 Marka eta izendapen komertzialiei dagokienez, ikus lege-oharra.
 Concernant les marques et dénominations commerciales voir la note dans l'index.

JMA Opening the future

JMA Opening the future

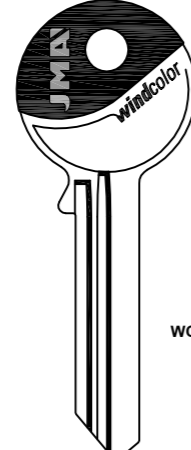
Beziehen auf die marke und handelsname sehen sie die notiz im Impressum.
 Relativamente às marcas e denominações comerciais, ver aviso legal.
 Ješli chodzí o znaki i nazwy handlowe, patrz Informacje prawne.

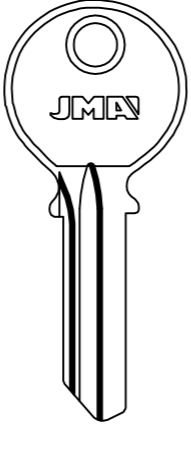
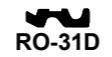
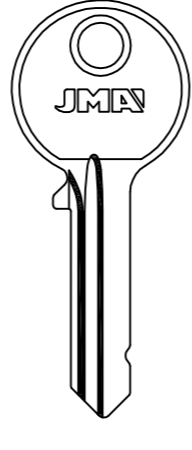
FOR: RONIS®











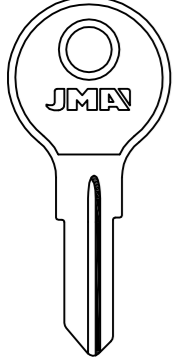
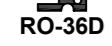
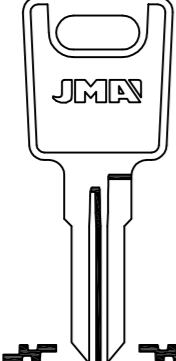
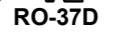

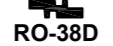
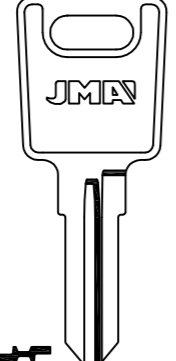



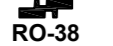

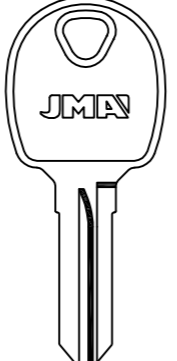



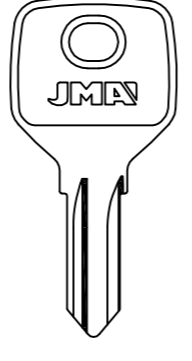





• WColor

.....1-1296
.....0 AL 9 AL 0
.....1 AL 9

FOR: ANTA® - LAPERCH® - SESA® FOR: FTH®

FOR: RONIS®











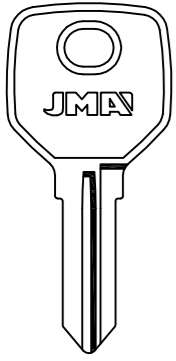

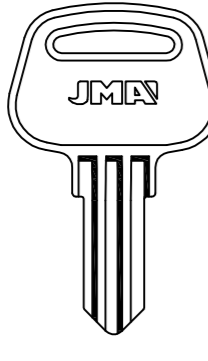

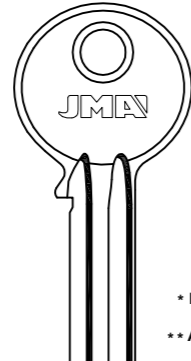









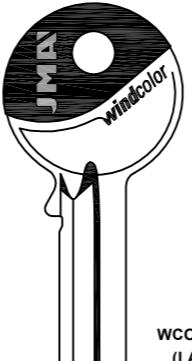











FOR: JD®

FOR: RONIS®

FOR: ROYAL®

FOR: RUKO®











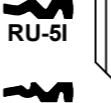



* LAT.
** ALU.
*** WColor

.....1 AL 8
.....1 AL 9
.....1 AL 9 AL 0 A-B
.....0 AL 9 A AL M
S.....1 AL 9

.....1 AL 8
.....1 AL 9
.....1 AL 9 AL 0 A-B
.....0 AL 9 A AL M
S.....1 AL 9

FOR: STUV® - FOR: WSS® FOR: DIFA®

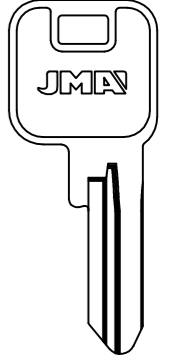
FOR: RUKO®

SKB
RU-11D

RU-12D

RU-14D

RU-15

RU-5I

RU-6I

RU-9I

RU-5D

RU-9D

RU-K

RU-L

RU-M

RU-7D











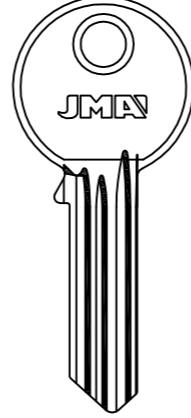

RU-13D

.....
1 AL 9 A AL C
RU-8D

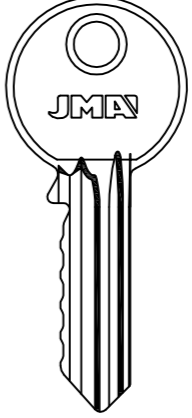
FOR: ASSA®

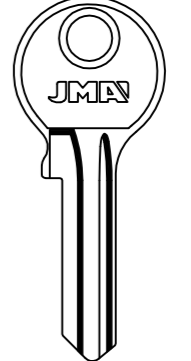
FOR: RUKO®

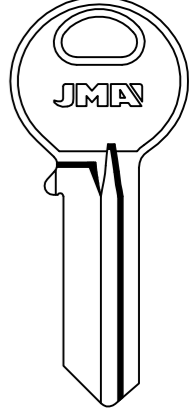
FOR: RUSSIA®









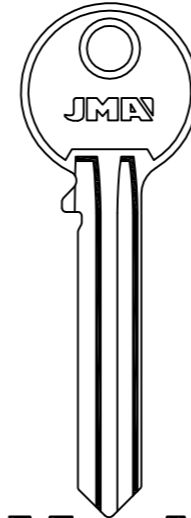

FOR: RUSSIA®

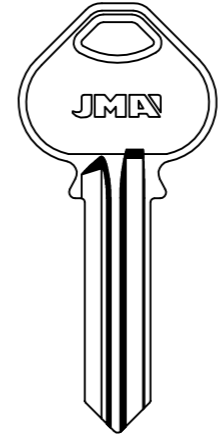
FOR: RUSSIA®

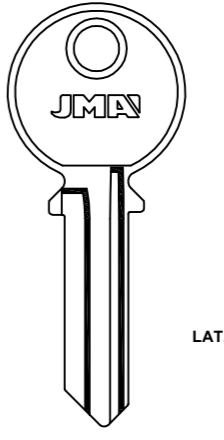
FOR: RUSSWIN®

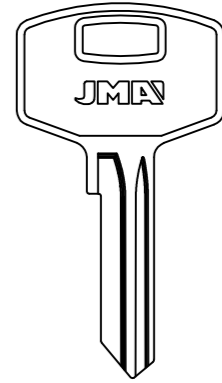
FOR: SABT®

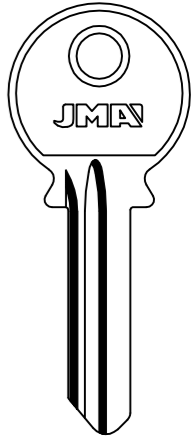
FOR: SAM®

LAT.

FOR: RUSSIA®

Concerning the marks and commercial denominations see legal warning.
Concerniente a las marcas y denominaciones comerciales ver aviso legal.
Marka eta izendapen komertzialiei dagokienez, ikus lege-oharra.
Concernant les marques et dénominations commerciales voir la note dans l'index.

JMA® Opening the future

JMA® Opening the future

Beziehen auf die Marke und Handelsname sehen sie die Notiz im Impressum.
Relativamente às marcas e denominações comerciais, ver aviso legal.
Jeśli chodzi o znaki i nazwy handlowe, patrz Informacje prawne.

FOR: SAM®

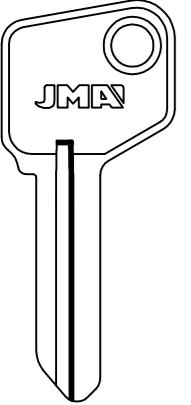

SAM-2D

FOR: SAMSONITE®

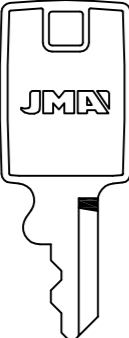

SA-1

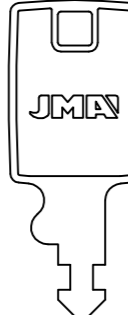

SA-1D

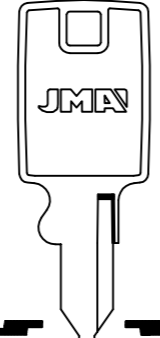

SA-3I

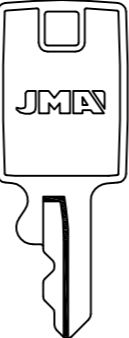

SA-3D

SE 041
SE 052
SE 083
SE 124
SE 165
SE 186

SA-4



SA-5D

FOR: SCHLAGE®

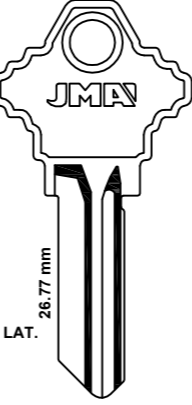

LAT. 26.77 mm

SLG-3
CE
SLG-13
E
SLG-11
EF
SLG-15
F
SLG-12
FG
SLG-21
G
SLG-22

H
SLG-23

J
SLG-24

K
SLG-25

L
SLG-14

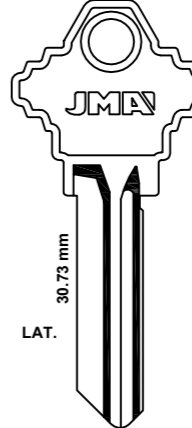

LAT. 30.73 mm

SLG-4
CE
SLG-8
E
SLG-5
EF
SLG-10
F
SLG-9
FG
SLG-19
G
SLG-18

H
SLG-16

J
SLG-17

K
SLG-20

L
SLG-6
ACE.

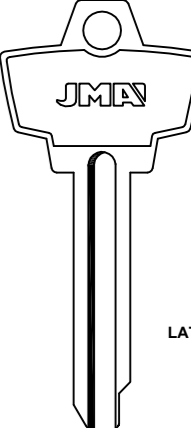

LAT.

A
SLG-7

FOR: SARGENT®

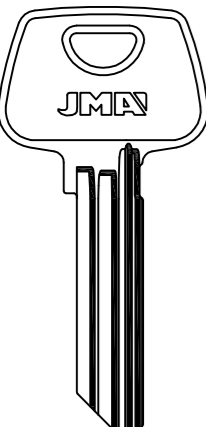

SAR-1

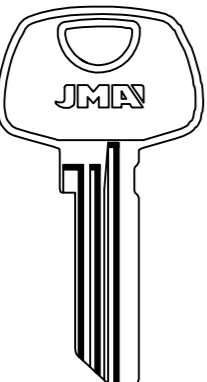

SAR-1D

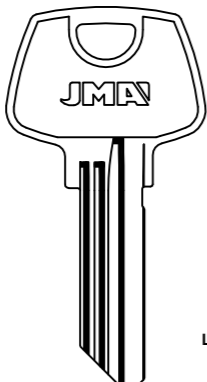

SAR-2D

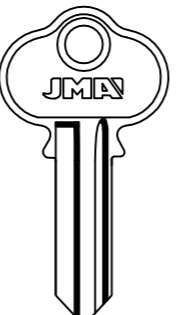

SAR-3D

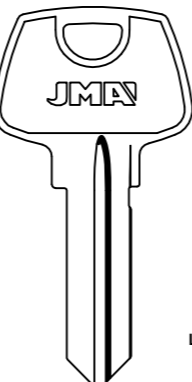

SAR-4

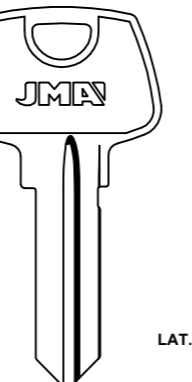

SAR-4D

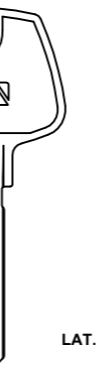

SAR-5D

LN
RN
S
1 AL 9

FOR: BRICARD® -SHOWA®

FOR: SCHLECHTENDAHL®

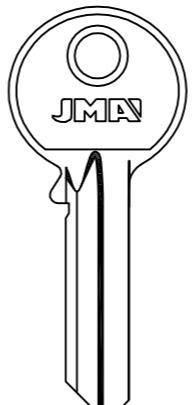

SCH-1D

FOR: SCHUCO®

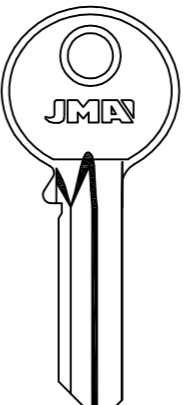

SCC-1D

FOR: SELECT®

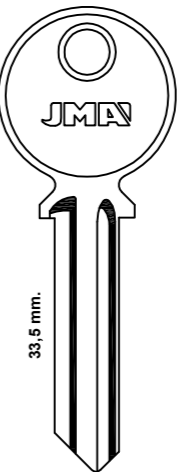

SEL-1I

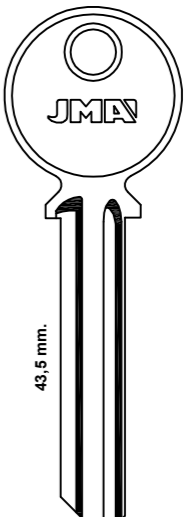

SEL-1D

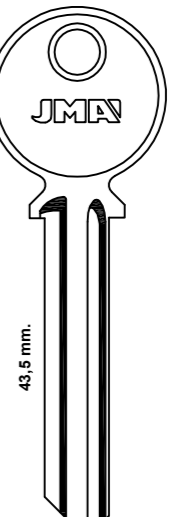

SEL-2I

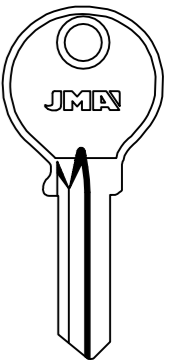

SEL-2D

SEL-3D

33.5 mm.
43.5 mm.

FOR: CASI® -HUTRA® -NORDWEST®

FOR: SARGENT®

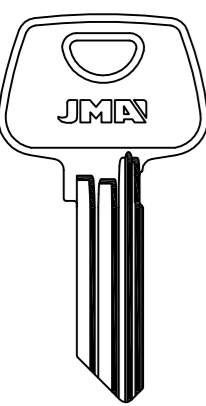

SAR-6

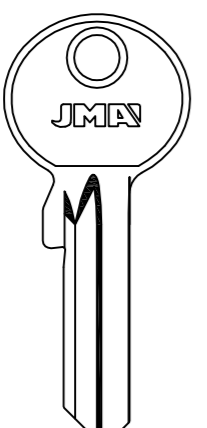

SAR-6D

FOR: SATURN®

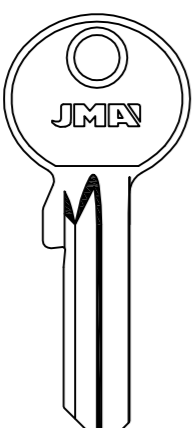

SAT-1D

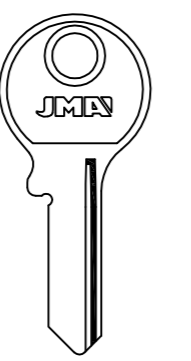

SAT-2

FOR: SCHÄRER®

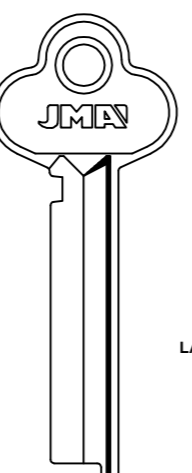

SHR-1

FOR: SCHLAGE®

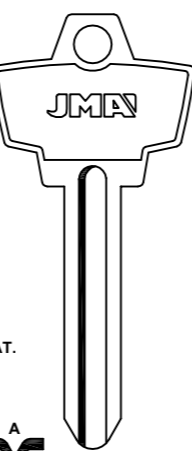

SLG-1

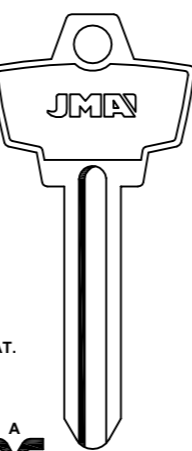

SLG-2

LN
RN
S
1 AL 9

FOR: GERA® -VERA®

FOR: EPO®

FOR: SELECT®

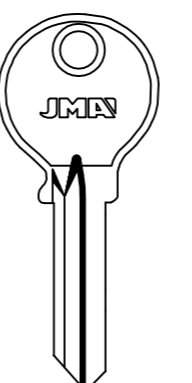

SEL-4D

FOR: SELIVANOVSK®

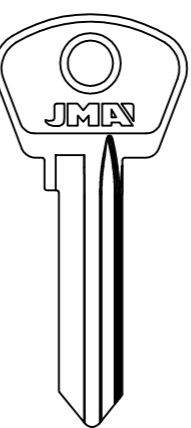

SL-1

FOR: SENTRY SAFE®

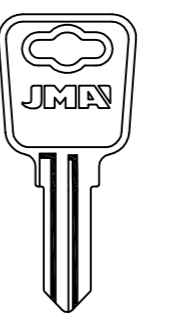

SEN-1D

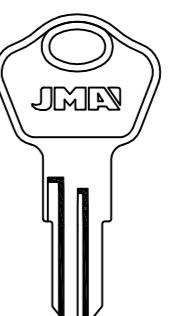

SEN-2D

FOR: SERRETA®

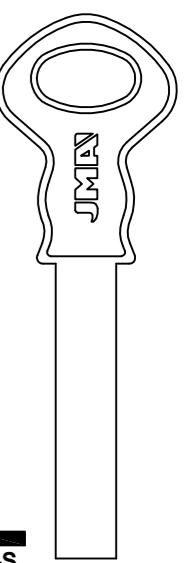

7-S

Concerning the marks and commercial denominations see legal warning.
 Concerniente a las marcas y denominaciones comerciales ver aviso legal.
 Marka eta izendapen komertzialiei dagokienez, ikus lege-oharra.
 Concernant les marques et dénominations commerciales voir la note dans l'index.

JMA® Opening the future

JMA® Opening the future

Beziehen auf die Marke und Handelsname sehen Sie die Notiz im Impressum.
 Relativamente às marcas e denominações comerciais, ver aviso legal.
 Jeśli chodzi o znaki i nazwy handlowe, patrz Informacje prawne.

FOR: SHANGAI® SHA-1 FOR: CINA®	FOR: SHAW® SH-11 FOR: HTV®-VAUGHN®-YALE®	FOR: SHAW WALKER® SWL-1 FOR: STORWALL®	FOR: SHILUTE® SHI-1, SHI-1D, SHI-2D, SHI-3D FOR: SHILUTE®	FOR: SIDESE® SID-1, SID-2 57.60, 57 ZAM. FOR: SIDESE®
--	--	--	---	---

FOR: SIMECA® SM-1, SM-2, SM-3, SM-3D, SM-4, SM-4D FOR: GUTLER®-KATE®-ORBA® FOR: SIAM®-SIMATIC®			FOR: SIS® SIS-1, SIS-2, SIS-6, SIS-6D, SIS-7D FOR: FEL® FOR: UTZ®-ZENITH®	
---	--	--	--	--

FOR: SIS® SIS-3, SIS-4D, SIS-5D, SIS-8, SIS-8D, SIS-9, SIS-9D FOR: LÁSBOLAGET®				
--	--	--	--	--

FOR: SISO® SSO-1, SSO-2 FOR: EVERGOOD®-JOMA®	FOR: SJL® SJL-1	FOR: SOFER® SOF-1, SOF-2 FOR: SIL®	FOR: SOFI SONAFI® MQ-2, SOFI-1, SOFI-1D, SOFI-2I, SOFI-2D FOR: SOBINCO® FOR: MARC®
--	------------------------	--	---

FOR: SOFI SONAFI® SOFI-3I, SOFI-4, SOFI-4D, SOFI-5, SOFI-6 FOR: SOBINCO® FOR: SOBINCO®			FOR: SOLER® SOL-1 90 mm	FOR: SOPRANO® SOP-1D
---	--	--	-----------------------------------	-----------------------------

FOR: SOS® SOS-1D, SOS-2D, SOS-3, SOS-4D, SOS-5 FOR: SOS®				
--	--	--	--	--

Concerning the marks and commercial denominations see legal warning.
 Concerniente a las marcas y denominaciones comerciales ver aviso legal.
 Marka eta izendapen komertzialiei dagokienez, ikus lege-oharra.
 Concernant les marques et dénominations commerciales voir la note dans l'index.



Beziehen auf die marke und handelsname sehen sie die notiz im Impressum.
 Relativamente às marcas e denominações comerciais, ver aviso legal.
 Jeśli chodzi o znaki i nazwy handlowe, patrz Informacje prawne.

FOR: SQUIRE & S.®

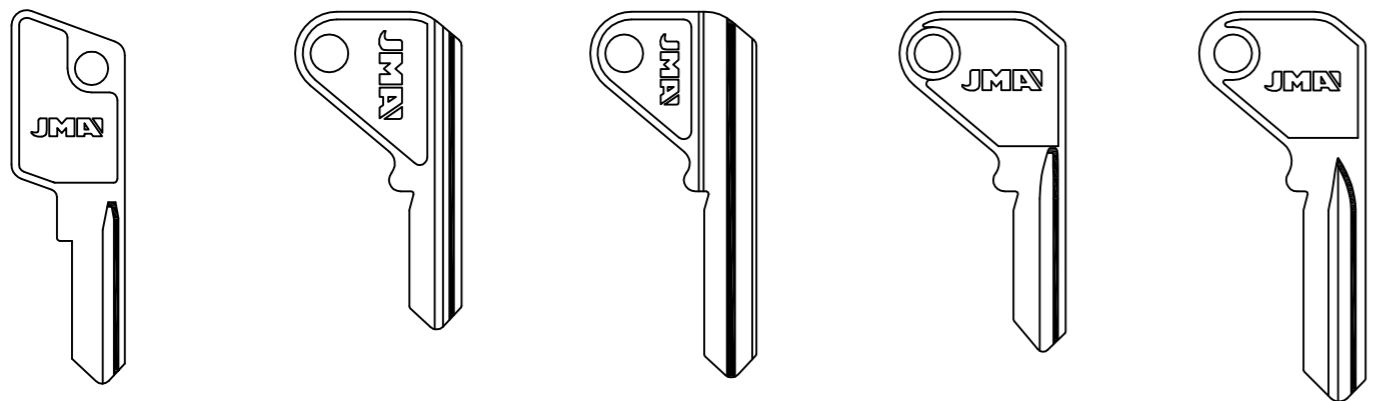

SQ-1 SQ-2 SQ-3D SQ-4 SQ-5D

FOR: SQUIRE & S.®

FOR: STA-LOCK®



SQ-6 SQ-7 SQ-8D

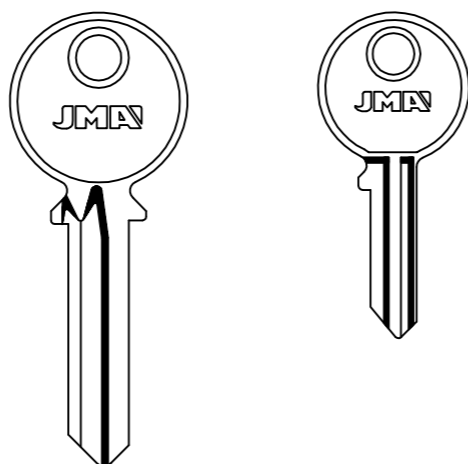

STL-1D STL-2I
FOR: SECURE® FOR: SECURE®

FOR: STAR®

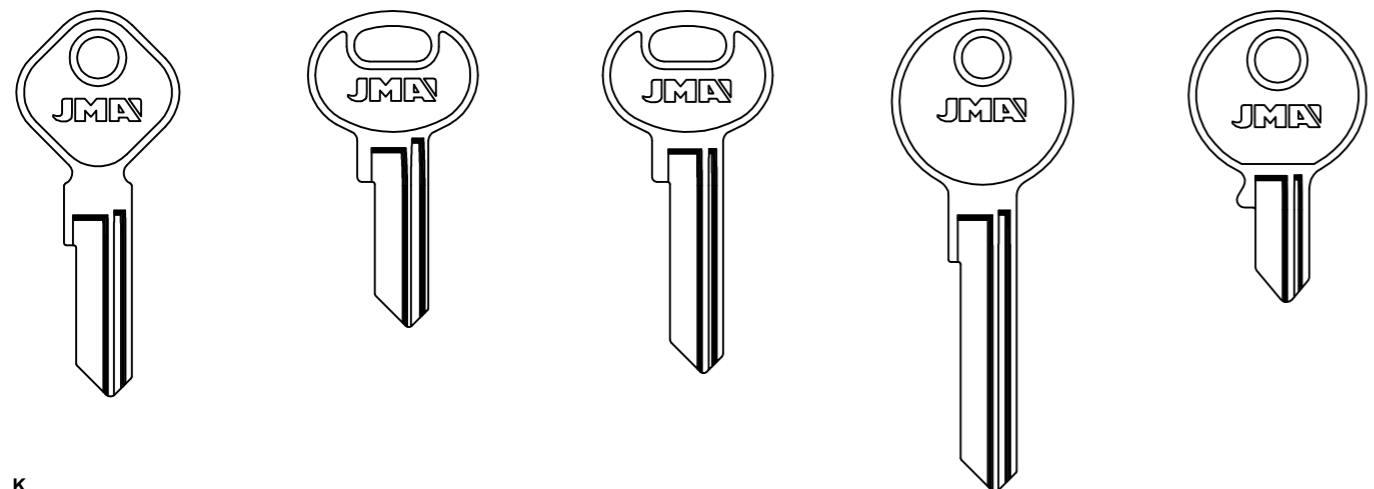

K... 1-1600
STA-1 STA-1D STA-2 STA-2D STA-3 STA-3D STA-4 STA-4D STA-5 STA-5D

FOR: STARLET®

FOR: STEKLOMASH®

FOR: STEM®

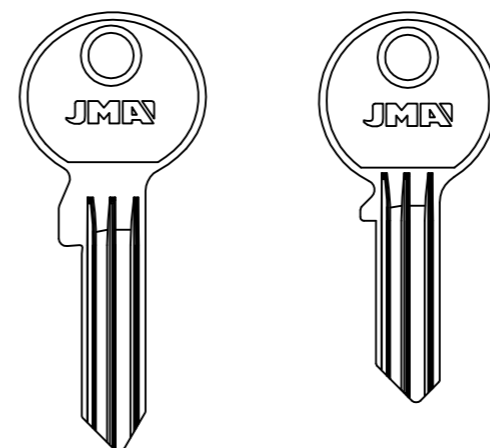

ST-1I ST-2

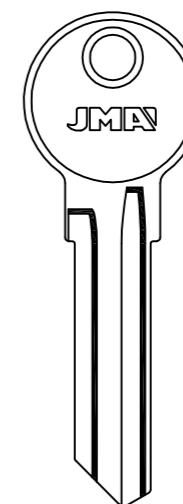

STK-1

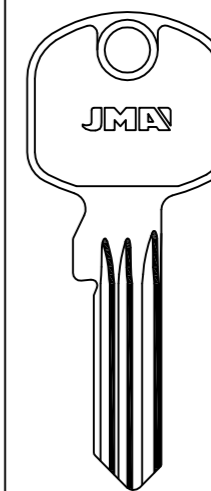

STE-1

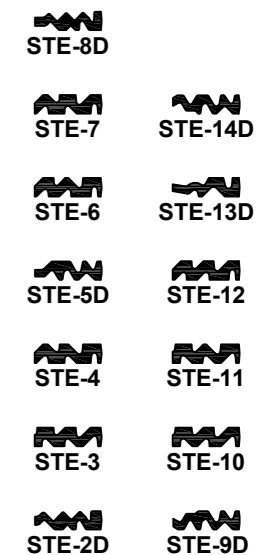

FOR: GE GE®

FOR: STERLING®

FOR: STREBOR®

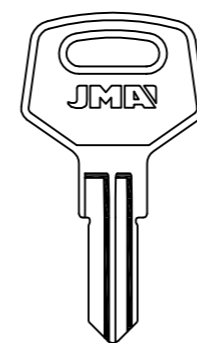

STG-1

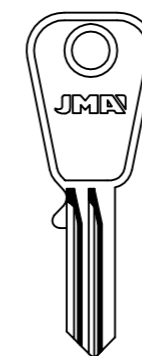

STR-1

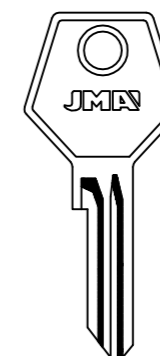

TS...300-369
STR-2
FOR: INNOCENTI®-TAYLOR®

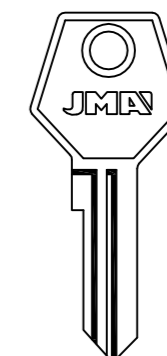

S..1-70
STR-4

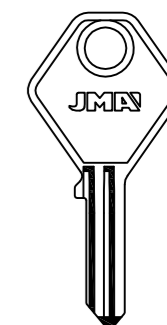

STR-5

FOR: STS®

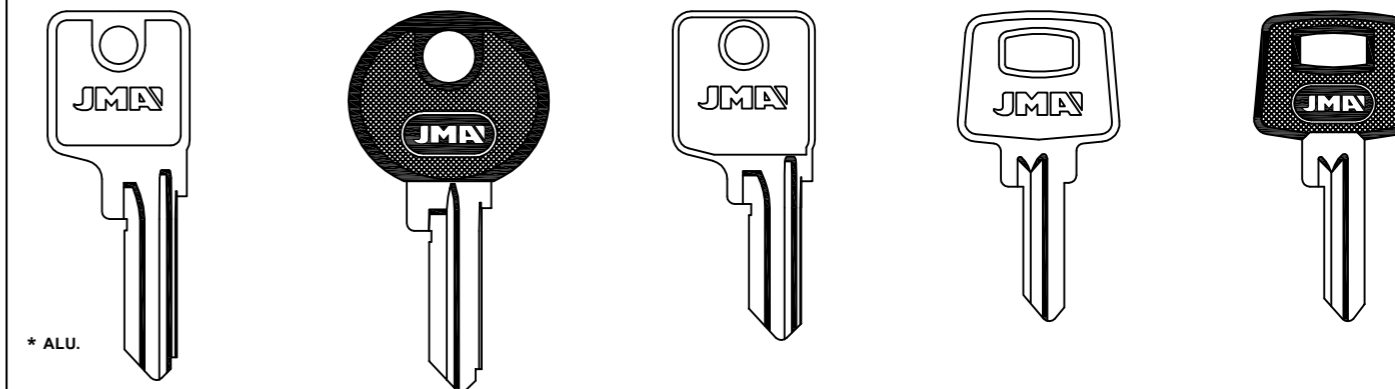

* ALU.
STS-1I * STS-1D

STS-28 STS-1D.P STS-3I STS-3D STS-4D STS-4D.P

FOR: SEMEL®

FOR: BTV®

FOR: BTV®

Concerning the marks and commercial denominations see legal warning.
Concerniente a las marcas y denominaciones comerciales ver aviso legal.
Marka eta izendapen komertzialiei dagokienez, ikus lege-oharra.
Concernant les marques et denominations commerciales voir la note dans l'index.

JMA® Opening the future

JMA® Opening the future

Beziehen auf die Marke und Handelsname sehen sie die Notiz im Impressum.
Relativamente às marcas e denominações comerciais, ver aviso legal.
Jeśli chodzi o znaki i nazwy handlowe, patrz Informacje prawne.

FOR: STS®

FOR: STUBLINA®

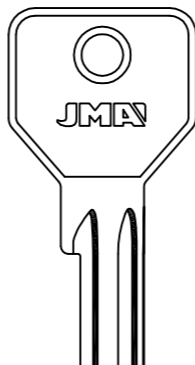
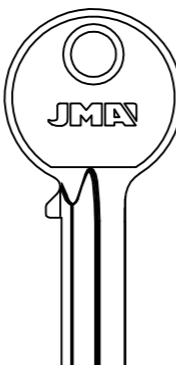
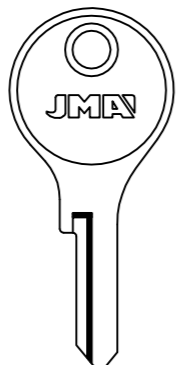
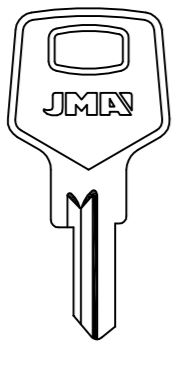
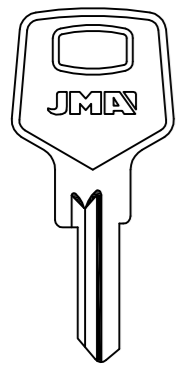

STS-6D

FOR: BTV®



STS-7D

FOR: BTV®



STS-12D

FOR: DAD®



STS-21D



STB-2



STB-2D

FOR: TALLINN®

FOR: TAYLOR®

FOR: TECHNO®

FOR: TECON®

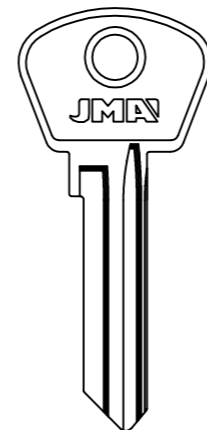

TAL-2

FOR: MR®

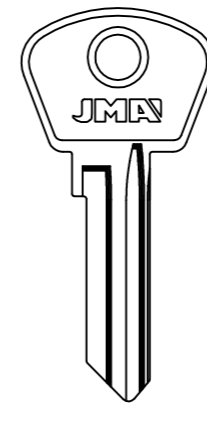

TAL-3

FOR: IFOS®

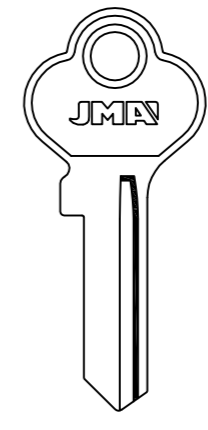

TAY-1

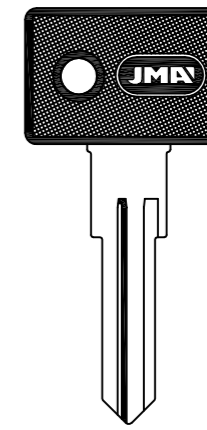

TCH-1.P

FOR: ET.POWER®

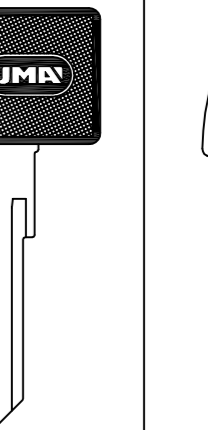

TCH-1D.P

FOR: STARRY LOCK®-STHALEX®

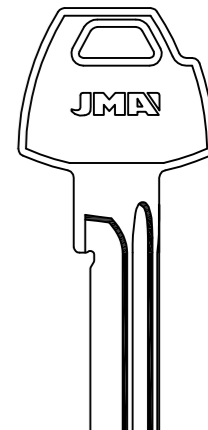

TC5

TC-2

FOR: STUMPF®

FOR: STUV®

FOR: SUREX®

FOR: TEICOCIL®

FOR: TEKA®

FOR: TEM®

FOR: TESA®

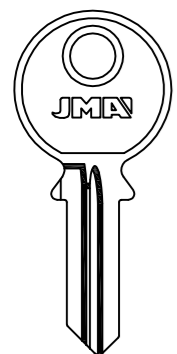

STF-1

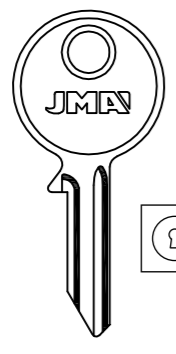

1F...201-278
1F...Z201-278
1F...X201-278

STUV-11

9F
STUV-3



2F...
201-278

STUV-1D

FOR: DOM®-MLM®

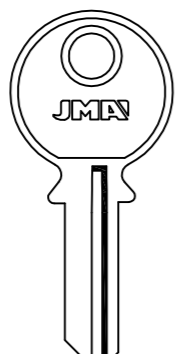

STUV-2

FOR: SUREX®

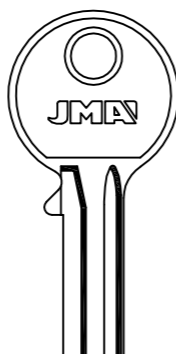

SR-1

FOR: ATLAS®

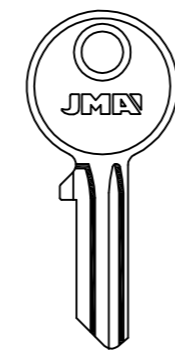

SR-2

FOR: ATLAS®

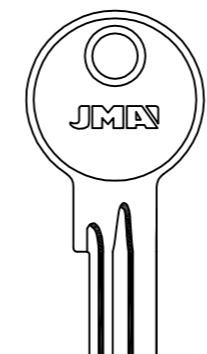

TEI-1D

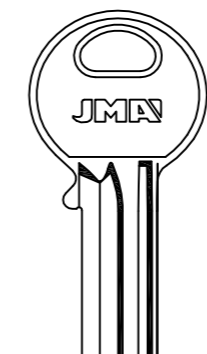

20104
TK-2I

FOR: ASSA®-ERMEX®-LM®



20004
TK-2D

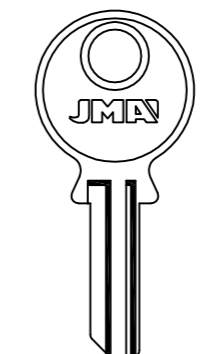

TEM-I35

FOR: CORSA®

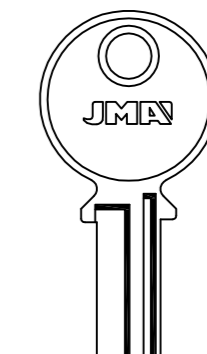

TEM-D35

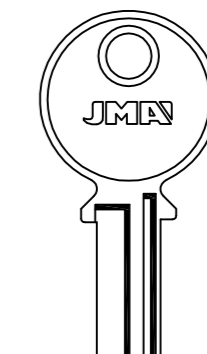

TEM-I55

FOR: CORSA®

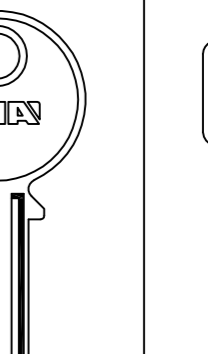

TEM-D55

FOR: CORSA®

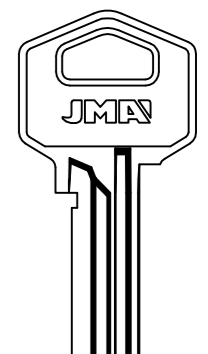

T

TE-1I

FOR: TESA®

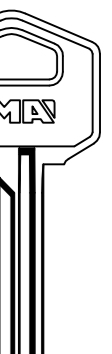

TE-1D

FOR: TESA®

FOR: SUREX®

FOR: TAITO®

FOR: TALLINN®

FOR: TESA®

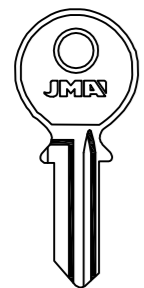

SR-3

FOR: ATLAS®-EUROP®-MATTEY®

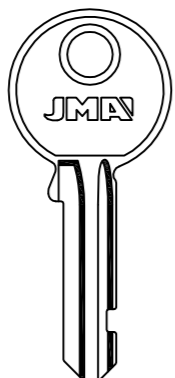

SR-4

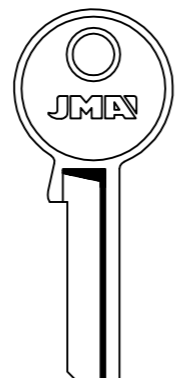

TAI-1

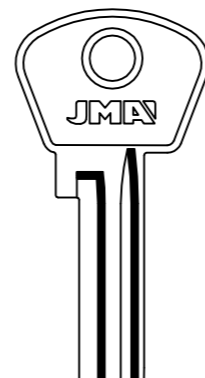

TAL-1



TAL-1D

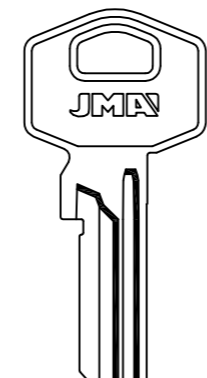

TE-3

FOR: MR®

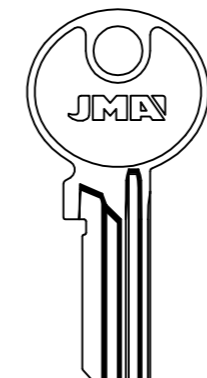

TE-4

FOR: IFOS®

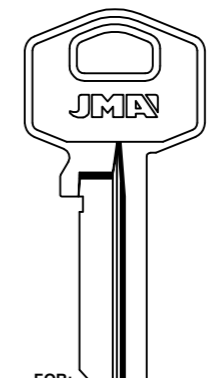

FOR: DONNER®

ESCO®

FORTRESS®

GAINSBOROUGH®

HARLOC®

KAWE®

MASTERCRAFT®

TAYMOR®

K

.....

0 AL 9

.....

AZ 1 AL 9

TE-7D

* FSH.

* ALU.

* LAT.

* MTIC.

* WColor

TE-8I

T.....

0 AL 9

TE-8DKT1

TE-8D

TE-8D

TE-8D

TE-8D

TE-8D

TE-8D

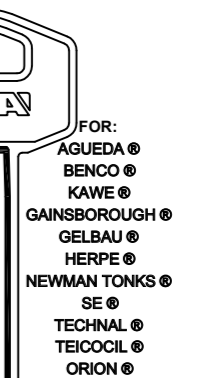

FOR: AGUEDA®

BENCO®

KAWE®

GAINSBOROUGH®

GELBAU®

HERPE®

NEWMAN TONKS®

SE®

TECHNAL®

TEICOCIL®

ORION®

VENLOCK®



JMA

wincolor

WColor

T.....

0 AL 9

TE-8I

TE-8I

TE-8I

TE-8I

TE-8I

TE-8I

TE-8I

TE-8I

TE-8I

TE-8I

TE-8I

TE-8I

TE-8I

Concerning the marks and commercial denominations see legal warning.
Concerniente a las marcas y denominaciones comerciales ver aviso legal.
Marka eta izendapen komertzialiei dagokienez, ikus lege-oharra.
Concernant les marques et denominations commerciales voir la note dans l'index.

JMA® Opening the future

JMA® Opening the future

Beziehen auf die marke und handelsname sehen sie die notiz im Impressum.
Relativamente às marcas e denominações comerciais, ver aviso legal.
Jeśli chodzi o znaki i nazwy handlowe, patrz Informacje prawne.

K01 / 97

FOR: TESA®

FOR: BURGHOWT®
CC®
DJC®
ESAFE®
IFOS®
INSTALL®
LUXOR®
METALCHIMEX®
METALUX®
SES®
SOS®

TE-9D

TE-10I TE-11D TE-23 TE-28

FOR: TH®

TH-1

H.R.S.-TRUMPH

FOR: TITAN®

TIT-2 TIT-10 TIT-19D TIT-2GD TIT-2D

TIT-3 TIT-4 TIT-5

FOR: FTH® -VACHETTE®

FOR: TICINO®

TI-1 TI-1D

FOR: BERTOLOTTI®

FOR: TIFON®

TIF-1D TIF-2D TIF-15/20 TIF-25D

FOR: TITAN®

ALU.

TIT-8D TIT-8GI TIT-8GD TIT-9 TIT-9D

TECH 5+
FOR: TECHPRO® - VBH®

FOR: LAMA®

...251-300
TIT-11D

TIT-12D TIT-13

FOR: PICARDIE®

FOR: TIFON®

TIF-30D TIF-40D TIF-50/60

FOR: TIGRIS®

TIG-1D

FOR: TITAN®

TIT-1D

FOR: HILLMANN® -PAYKAN®

FOR: TITAN®

TIT-15 TIT-16D TIT-15D TIT-17 TIT-25 TIT-24

FOR: PICARDIE®

FOR: T-KEY®

TKY-1

FOR: TOK WINKHAUS®

TOK-2 TOK-2D

FOR: TRELOCK®

Concerning the marks and commercial denominations see legal warning.
 Concerniente a las marcas y denominaciones comerciales ver aviso legal.
 Marka eta izendapen komertzialiei dagokienez, ikus lege-oharra.
 Concernant les marques et dénominations commerciales voir la note dans l'index.

JMA® Opening the future

JMA® Opening the future

Beziehen auf die Marke und Handelsname sehen Sie die Notiz im Impressum.
 Relativamente às marcas e denominações comerciais, ver aviso legal.
 Jeśli chodzi o znaki i nazwy handlowe, patrz Informacje prawne.

FOR: TRELOCK®

FOR: HAMPTON®

FOR: TRI STAR®

FOR: TRI-CIRCLE®

FOR: TRIMARK®

FOR: TRI-CIRCLE®

FOR: MARK®

FOR: ELEPHANT®

FOR: TRIO-VING®

FOR: TRIO®

FOR: TRI-CIRCLE®

FOR: TRIO-VING®

FOR: JOLI SAFE®

Concerning the marks and commercial denominations see legal warning.
 Concerniente a las marcas y denominaciones comerciales ver aviso legal.
 Marka eta izendapen komertzialiei dagokienez, ikus lege-oharra.
 Concernant les marques et dénominations commerciales voir la note dans l'index.



Beziehen auf die marke und handelsname sehen sie die notiz im Impressum.
 Relativamente às marcas e denominações comerciais, ver aviso legal.
 Jeśli chodzi o znaki i nazwy handlowe, patrz Informacje prawne.



FOR: UNION®

503
UN-28I
574
UN-29I
575
UN-30I
576
UN-31I
577
UN-32I
578
UN-33I
579
UN-34I

581
UN-35I
582
UN-36I
583
UN-37I
584
UN-38I
585
UN-39I
586
UN-40I
587
UN-41I
588
UN-42I
589
UN-43I

914
UN-29D
915
UN-30D
916
UN-31D
917
UN-32D
918
UN-33D
919
UN-34D

901
UN-35D
902
UN-36D
903
UN-37D
904
UN-38D
905
UN-39D
906
UN-40D
907
UN-41D
908
UN-42D
909
UN-43D

UN-8I

UN-8D

UN-9I

UN-9D

FOR: UNION®

UN-10I

UN-10D

UN-45D

UN-46D

UN-47

UN-FK

UN-FS

KB502
.....
1 AL 6
UN-11

KB682

TBS...1-50
NKL...1-150
NND...1-150
TBS...1-500
TBS...201-350

FK...
01-99
876-955

FS...
01-99
876-955

FOR: ONIUM®

FOR: JAGUAR®-VAUXHALL®
FOR: WBH®

UNIVERSAL

TX-3D

TX-12

TX-13D

U-1I

U-1D

U-2I

U-2D

G05
TX-16

FOR: EURO SPEC®

FOR: FLOK®

FOR: EURO SPEC®

FOR: TECNO®

UNIVERSAL

U-3I

U-3D

U-4I

U-4D

U-4AI

U-4AD

U-4GD

U-4JI

U-4JD

ALU.

UNIVERSAL

U-4TI

U-4TD

U-5I

U-5D

U-5AI

U-5AD

U-5BI

U-5BD

ALU.
FSH.

WCOLOR

FOR: ESAFE®-SIL®

FOR: ESAFE®-SIL®

UNIVERSAL

U-5CI

U-5CD

U-5DI

U-5DD

U-5EI

U-5ED

U-5FI

U-5FD

U-5GD

Concerning the marks and commercial denominations see legal warning.
 Concerniente a las marcas y denominaciones comerciales ver aviso legal.
 Marka eta izendapen komertzialiei dagokienez, ikus lege-oharra.
 Concernant les marques et denominations commerciales voir la note dans l'index.

JMA Opening the future

JMA Opening the future

Beziehen auf die marke und handelsname sehen sie die notiz im Impressum.
 Relativamente às marcas e denominações comerciais, ver aviso legal.
 Jeśli chodzi o znaki i nazwy handlowe, patrz Informacje prawne.

UNIVERSAL

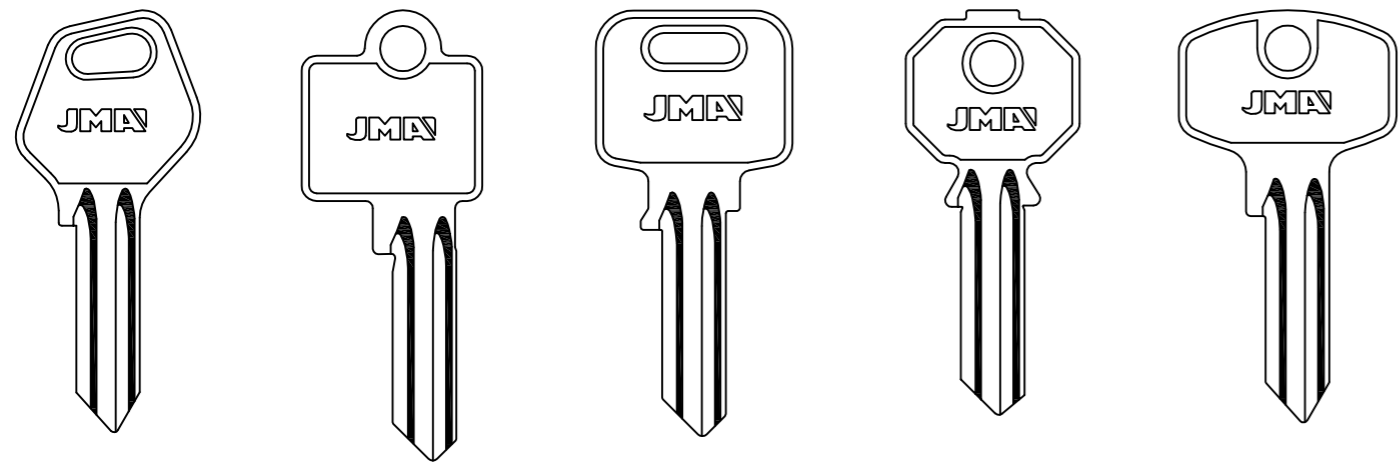

U-5JI U-5JD U-5KI U-5KD U-5MI U-5MD U-5PI U-5PD U-5QI U-5QD

UNIVERSAL

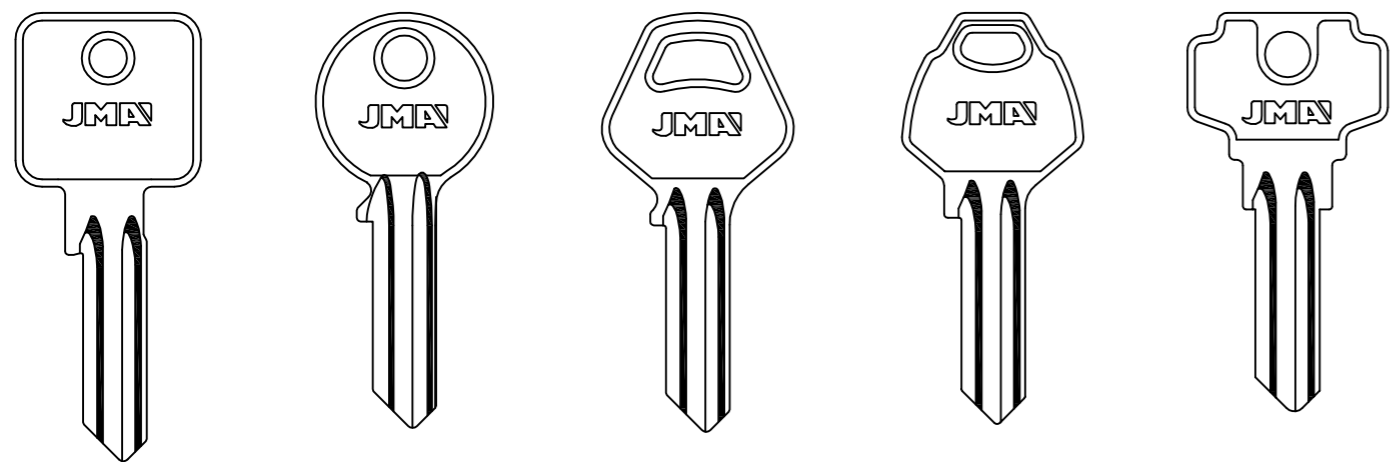

U-5SI U-5SD U-5SP U-5DSP U-5TI U-5TD U-5VI U-5VD U-5XI U-5XD

UNIVERSAL

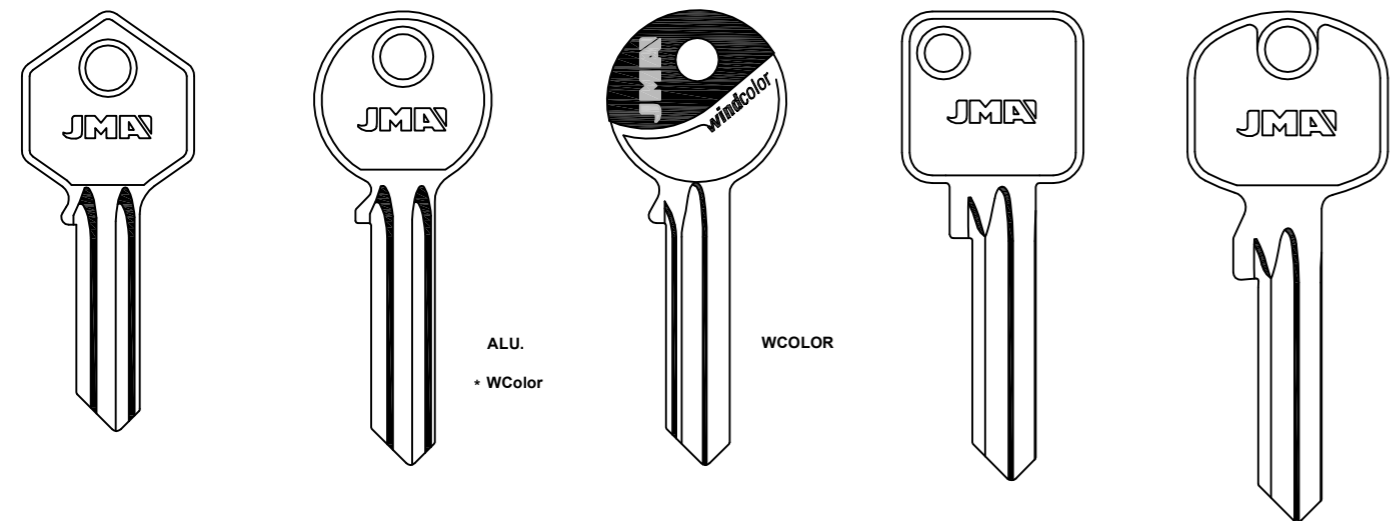

U-5YI U-5YD U-6I U-6D U-6BD U-6GD

UNIVERSAL

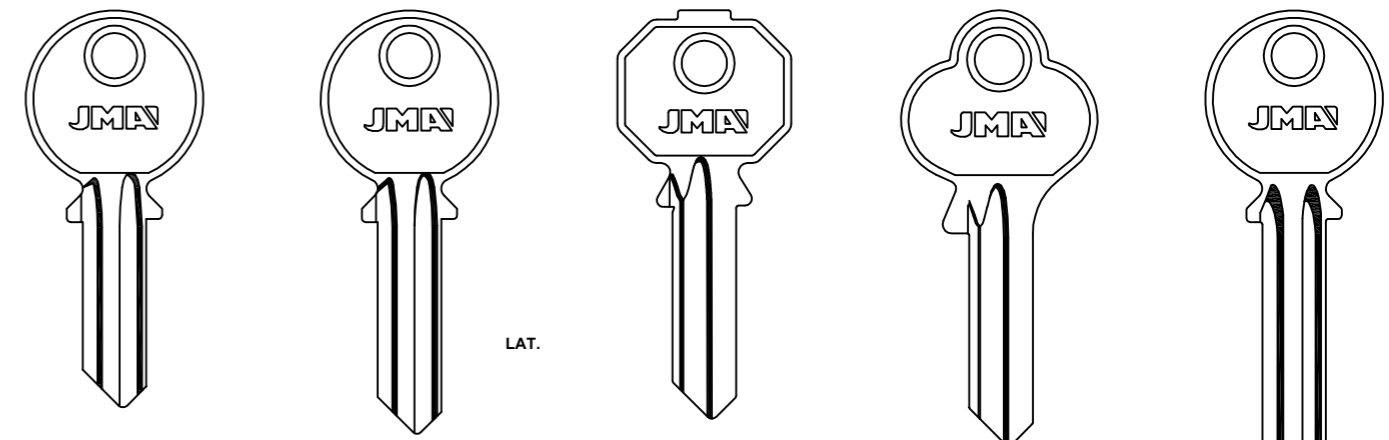

U-7 U-7D U-8 U-8D U-8PD U-8TD U-9 U-9D

UNIVERSAL

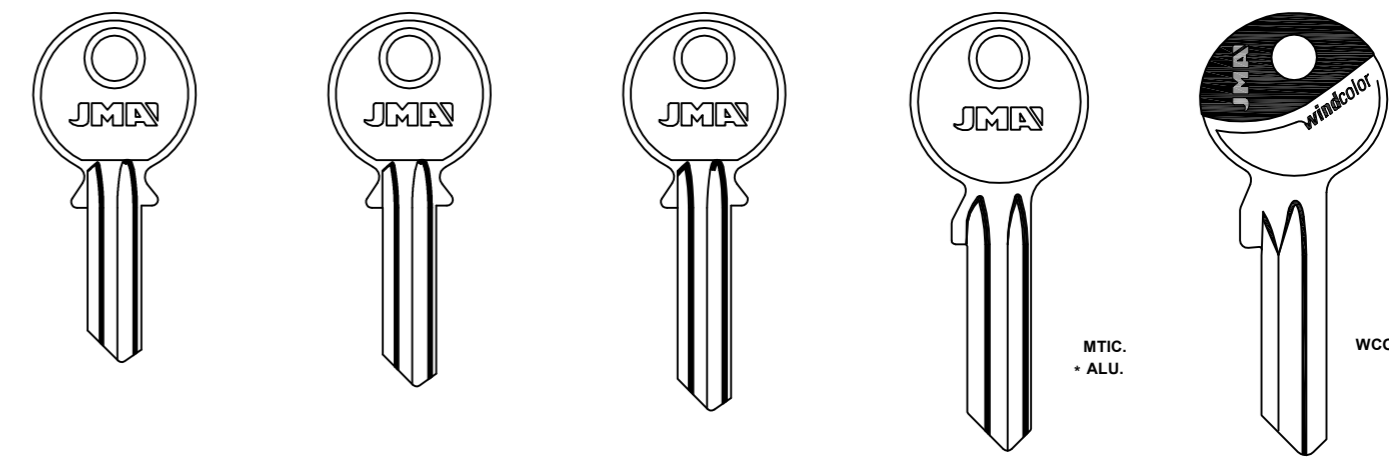

U-10I U-10D U-13I U-13D U-14I U-14D U-15 U-15D U-15D

FOR: GIESSE TVO-3D

TVO-2D

UNIVERSAL

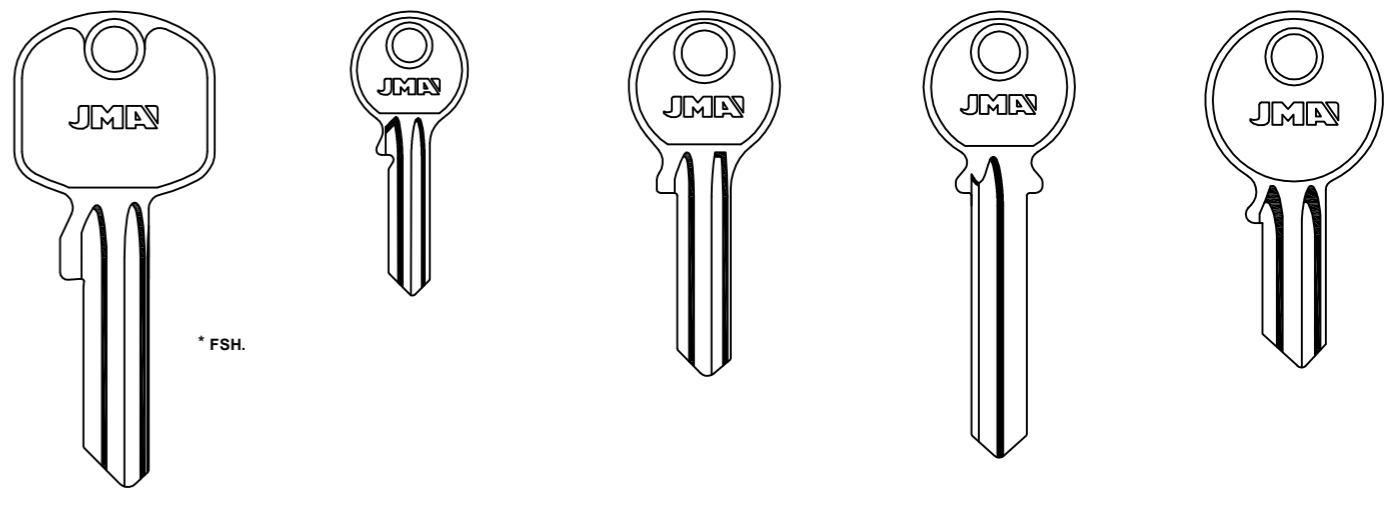

U-15GI U-15GD U-16 U-16D U-17 U-17D U-18D U-19 U-19D

TVO-4D

FOR: CISA LOGO

Concerning the marks and commercial denominations see legal warning.
 Concerniente a las marcas y denominaciones comerciales ver aviso legal.
 Marka eta izendapen komertzialiei dagokienez, ikus lege-oharra.
 Concernant les marques et denominations commerciales voir la note dans l'index.

JMA Opening the future

JMA Opening the future

Beziehen auf die marke und handelsname sehen sie die notiz im Impressum.
 Relativamente às marcas e denominações comerciais, ver aviso legal.
 Jeśli chodzi o znaki i nazwy handlowe, patrz Informacje prawne.

FOR: VACHETTE®

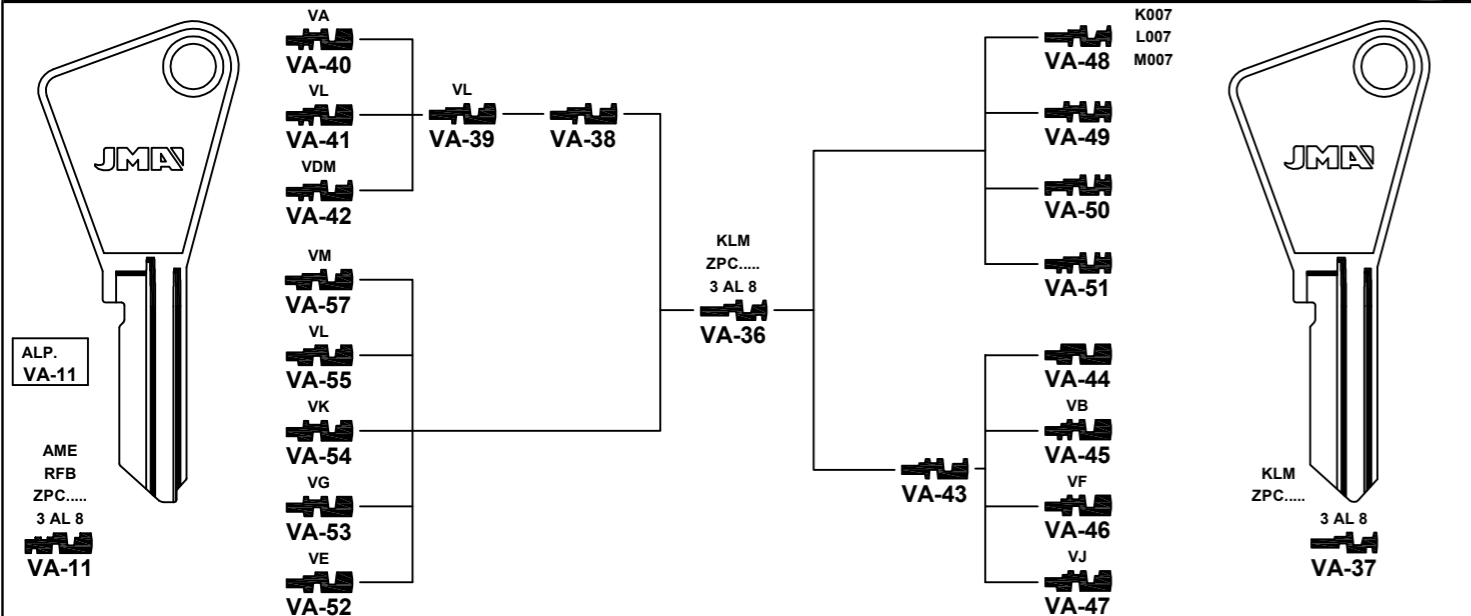

FOR: VACHETTE®

VARIOS

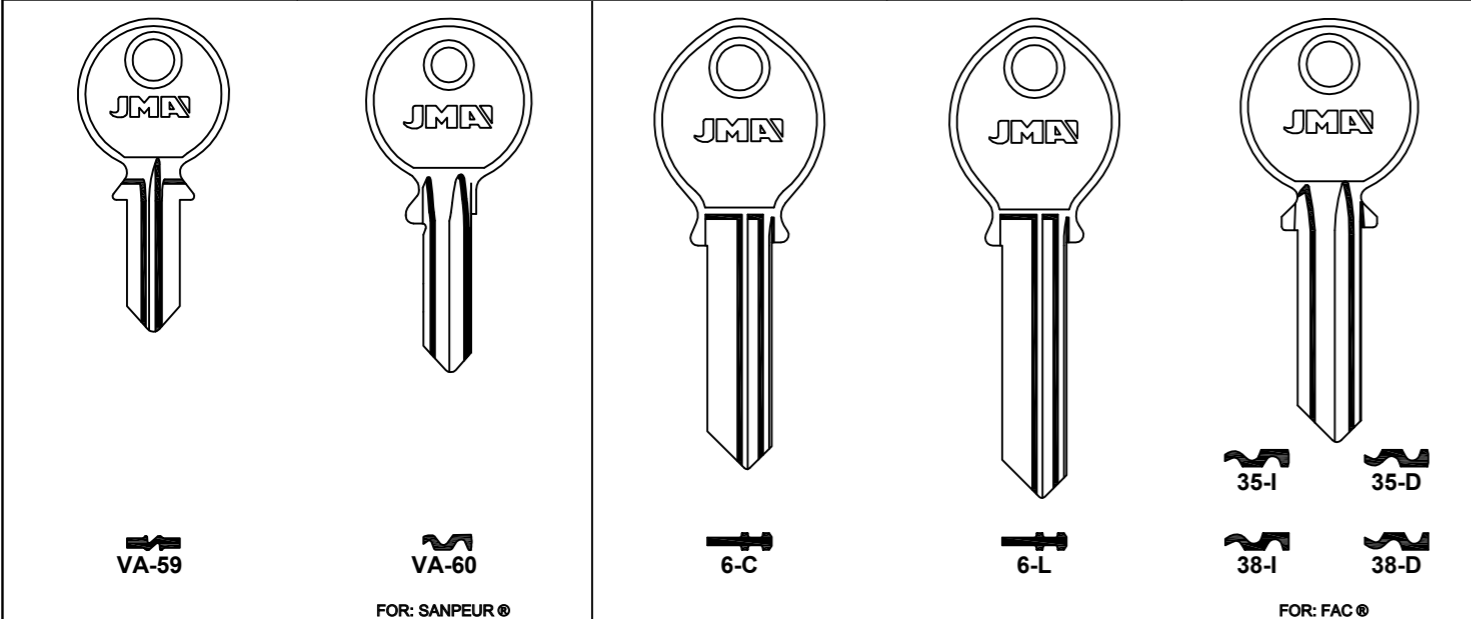

VARIOS

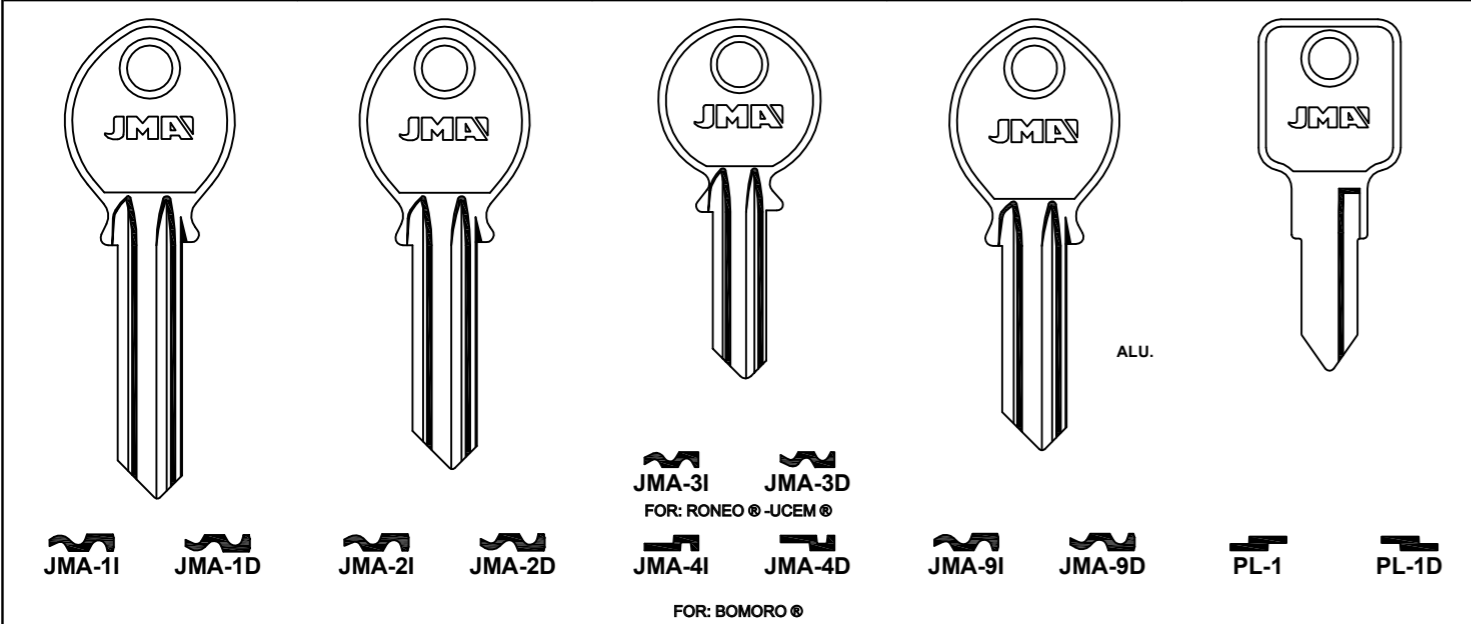

FOR: VBH®

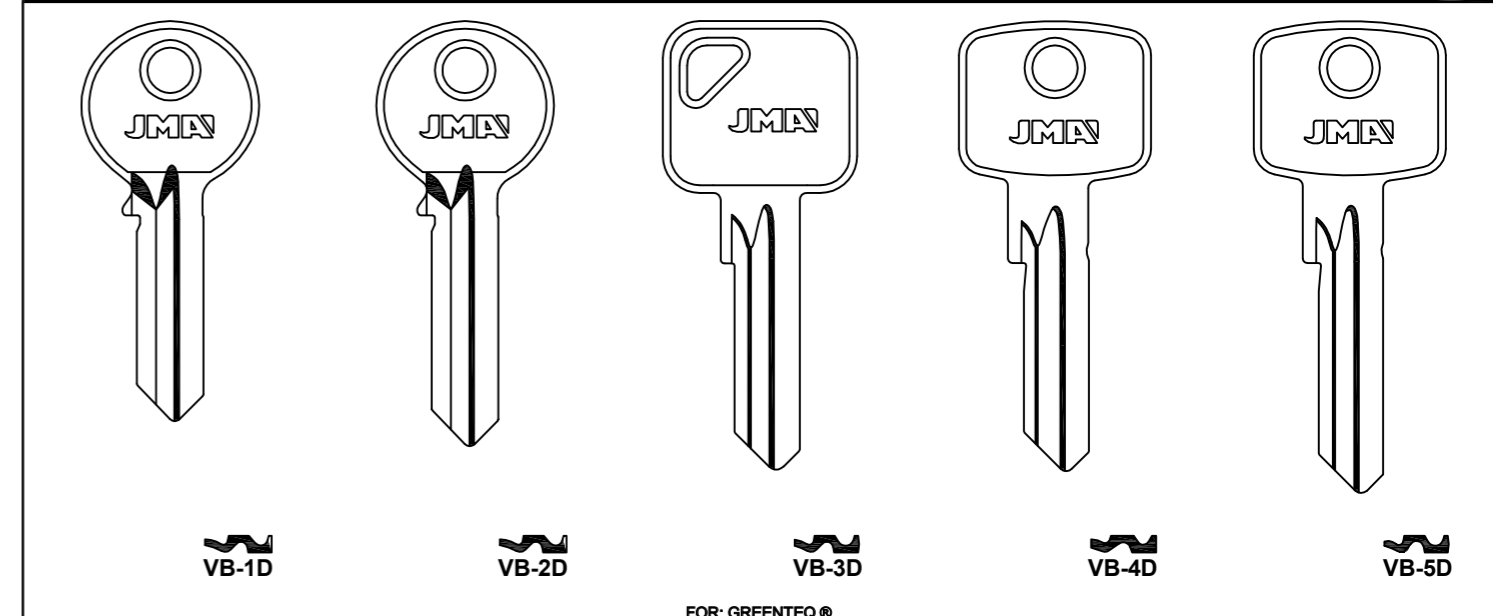

FOR: VEGA®

FOR: VENDI®

FOR: VGF VILLATORE®

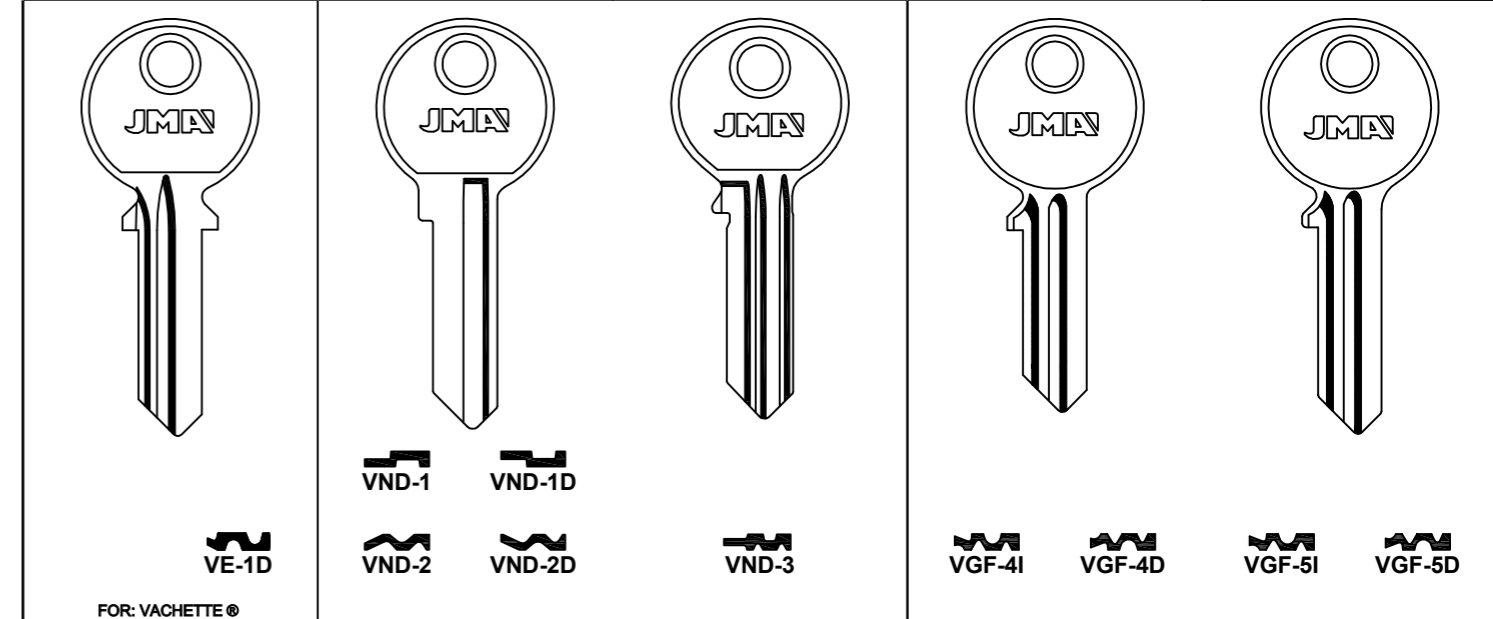

FOR: VING®

FOR: VIRO®

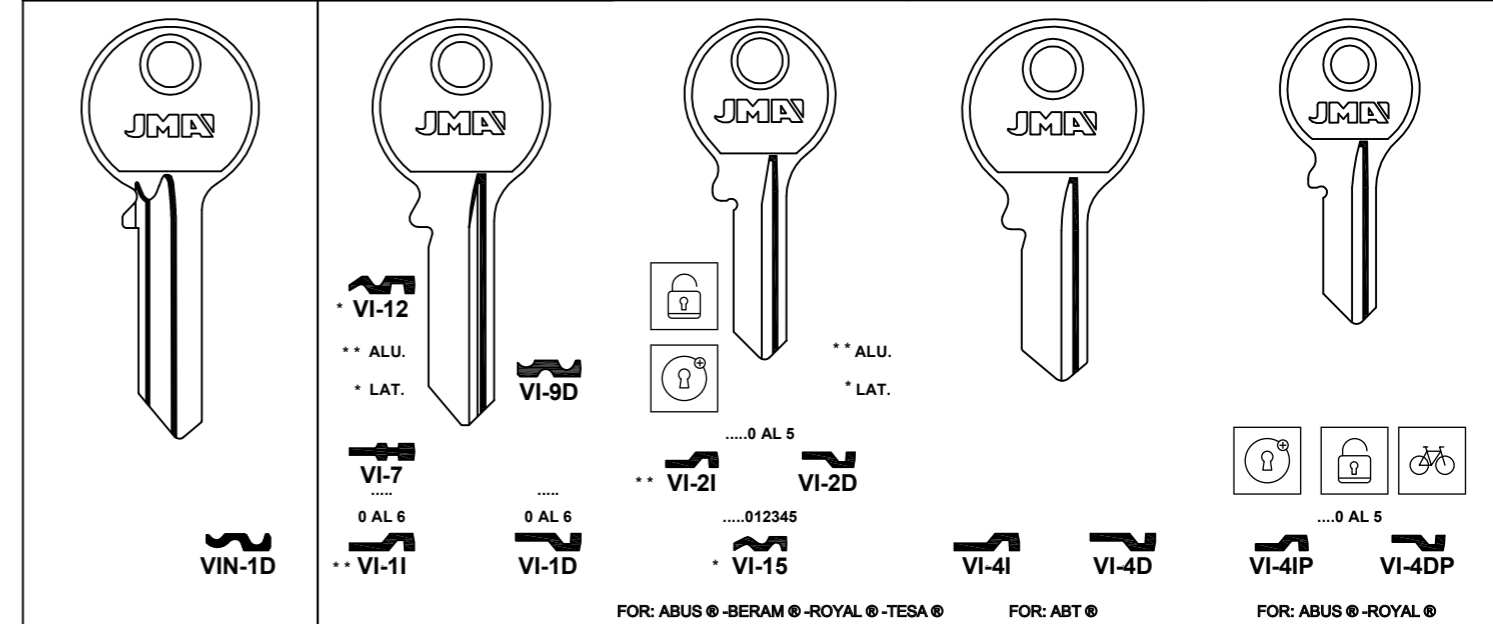

Concerning the marks and commercial denominations see legal warning.
 Concerniente a las marcas y denominaciones comerciales ver aviso legal.
 Marka eta izendapen komertzialiei dagokienez, ikus lege-oharra.
 Concernant les marques et dénominations commerciales voir la note dans l'index.

JMA® Opening the future

JMA® Opening the future

Beziehen auf die marke und handelsname sehen sie die notiz im Impressum.
 Relativamente às marcas e denominações comerciais, ver aviso legal.
 Jeśli chodzi o znaki i nazwy handlowe, patrz Informacje prawne.

FOR: VIRO®

LAT.

0 AL 7

SPECIAL

TS

FOR: ABT® FOR: ABUS®-BURG®

FOR: VIRO® **FOR: VOLGOGRAD®** **FOR: VOLKOVYSK®** **FOR: WALLY®**

LAT.

LAT.

FOR: FAI®

FOR: WALLY® **FOR: WALRUS®**

LAT.

ALU.

FOR: MOREAUX®

FOR: WEBER® **FOR: WEBSTER®** **FOR: WEISER®**

LAT.

FOR: WECO® FOR: KAWE® FOR: FALCON®-FICHET® FOR: IDEAL SECURITY®

FOR: WEISER® **FOR: WELKA®**

LAT.

FOR: FALCON® FOR: FALCON®

FOR: WESLOCK® **FOR: WEST LOCK®** **FOR: WHITCO®** **FOR: WILKA®**

LAT.

ALU.

FOR: JORE®-WIGRO®

Concerning the marks and commercial denominations see legal warning.
 Concerniente a las marcas y denominaciones comerciales ver aviso legal.
 Marka eta izendapen komertzialiei dagokienez, ikus lege-oharra.
 Concernant les marques et dénominations commerciales voir la note dans l'index.

JMA® Opening the future

JMA® Opening the future

Beziehen auf die marke und handelsname sehen sie die notiz im Impressum.
 Relativamente às marcas e denominações comerciais, ver aviso legal.
 Jeśli chodzi o znaki i nazwy handlowe, patrz Informacje prawne.

K01 / 115

FOR: WILKA®

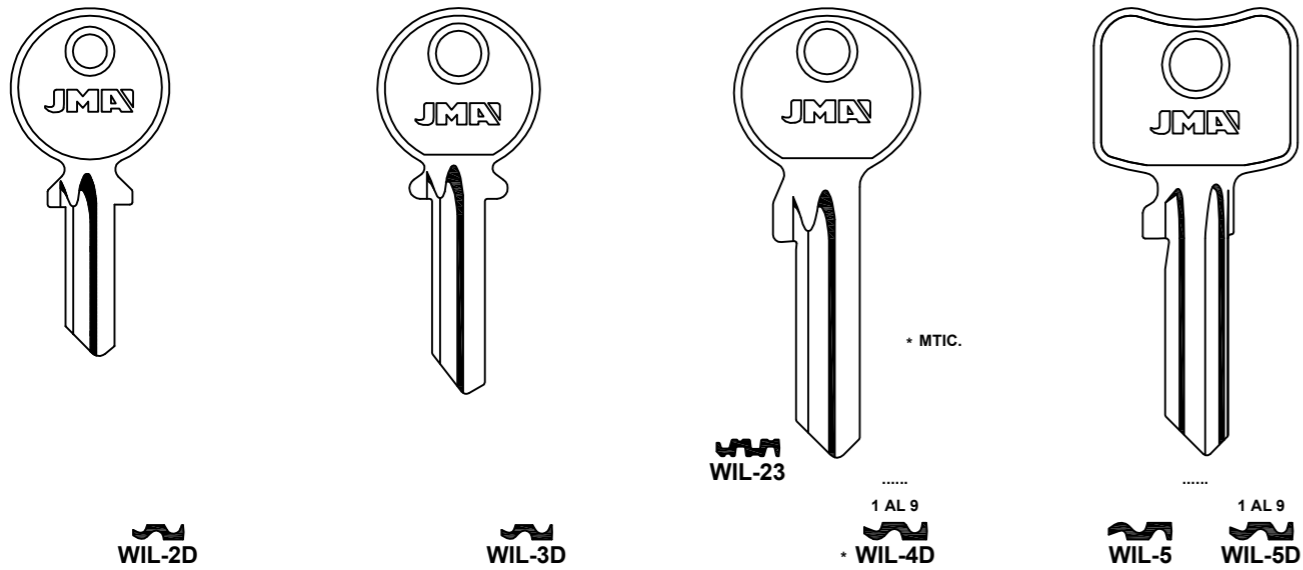

WIL-2D

WIL-3D

WIL-23

1 AL 9
WIL-4D

WIL-5

1 AL 9
WIL-5D

FOR: CFP®-GBS®

FOR: JORE®-WIGRO®

FOR: WILKA®

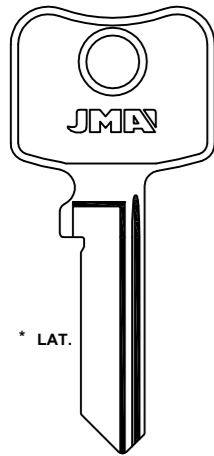

* LAT.



FOR: WILKA®

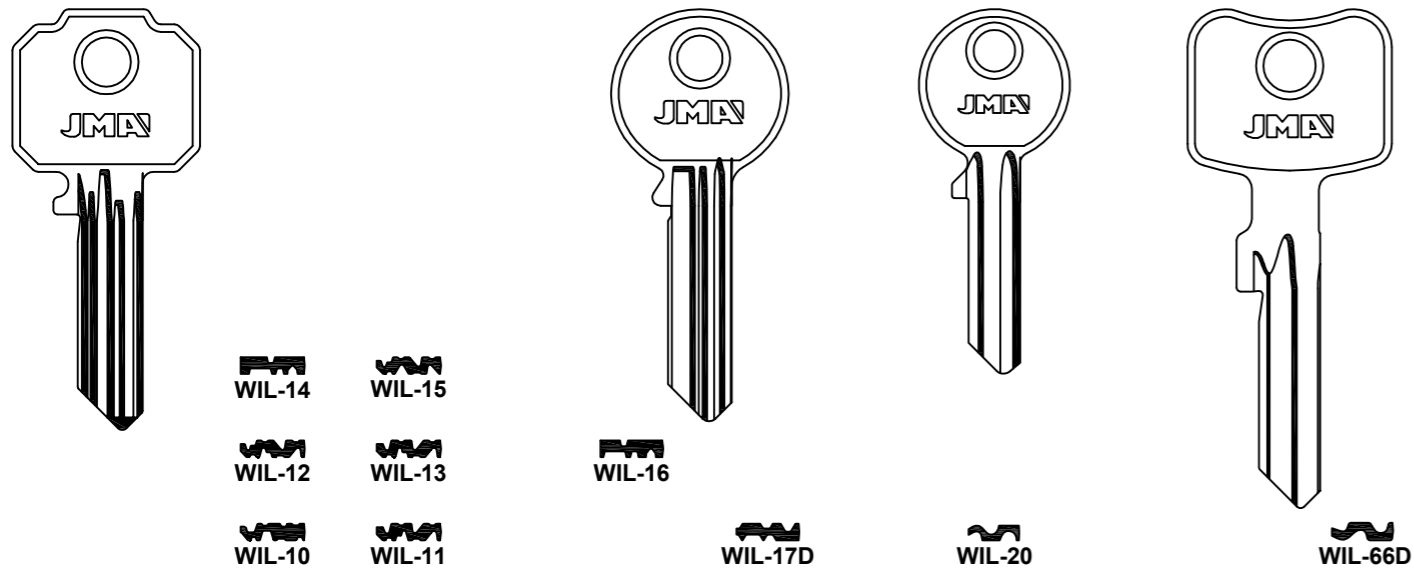

WIL-14

WIL-15

WIL-16

WIL-17D

WIL-20

WIL-66D

FOR: BIFFAR®-BEFA®

FOR: WINKHAUS®

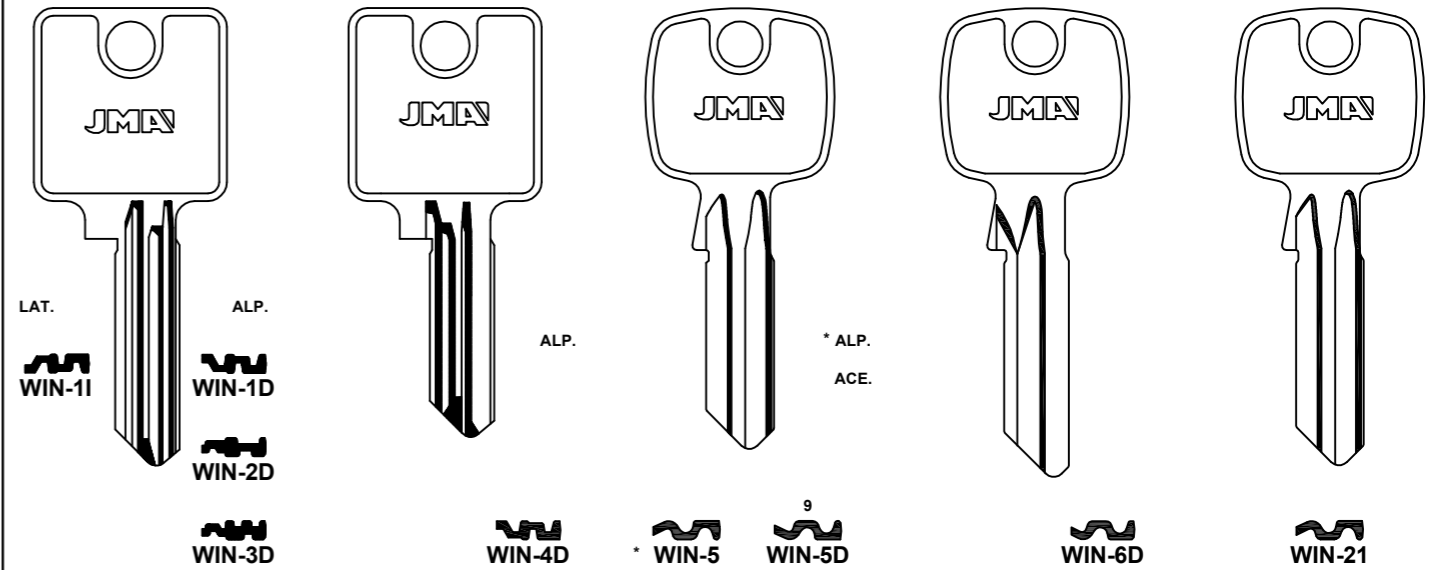

LAT.

WIN-11

ALP.

WIN-1D

WIN-2D

WIN-3D

ALP.

WIN-4D

* ALP.

ACE.

WIN-5

9
WIN-5D

WIN-6D

WIN-21

FOR: AZBE®

FOR: AZBE®

FOR: WINKHAUS®

FOR: WINLOCK®

FOR: WIREROPE®

FOR: WMS®

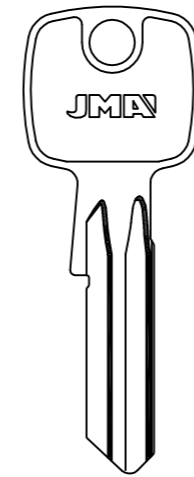

WIN-22

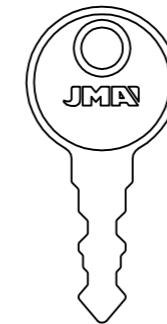

WNC-1

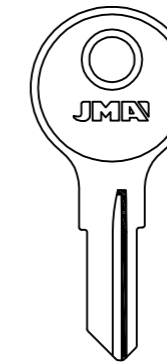

WIR-1

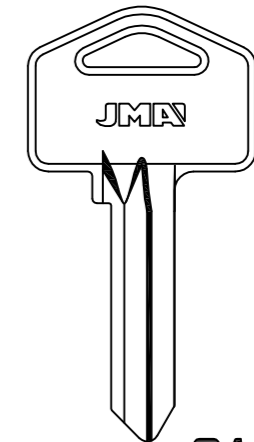

WM-1D

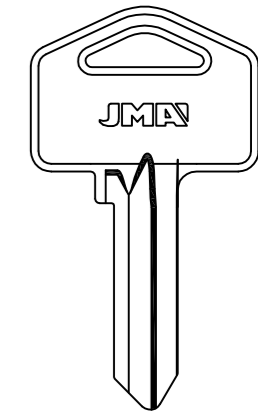

WM-2D

WM-3D

FOR: WMS®

FOR: WT®

FOR: YALE®

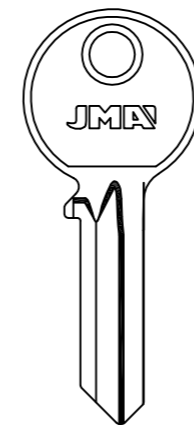

WM-4D

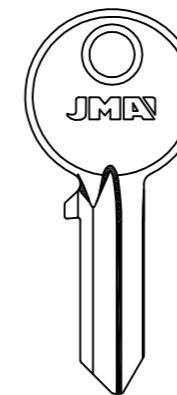

WM-5D

FOR: I.R.®-TITUS®

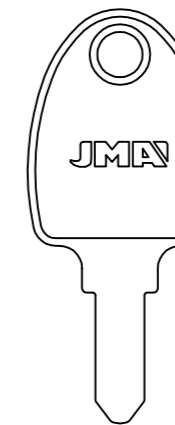

WT-1

LAT.

ALU.

ALU.

YA-1I

YA-1D

.....0 AL 9

YA-32D

FOR: WALE®

YA-2I

YA-2D

.....0 AL 9

YA-2I

YA-2D

Concerning the marks and commercial denominations see legal warning.
 Concerniente a las marcas y denominaciones comerciales ver aviso legal.
 Marka eta izendapen komertzialiei dagokienez, ikus lege-oharra.
 Concernant les marques et dénominations commerciales voir la note dans l'index.

FOR: YALE®

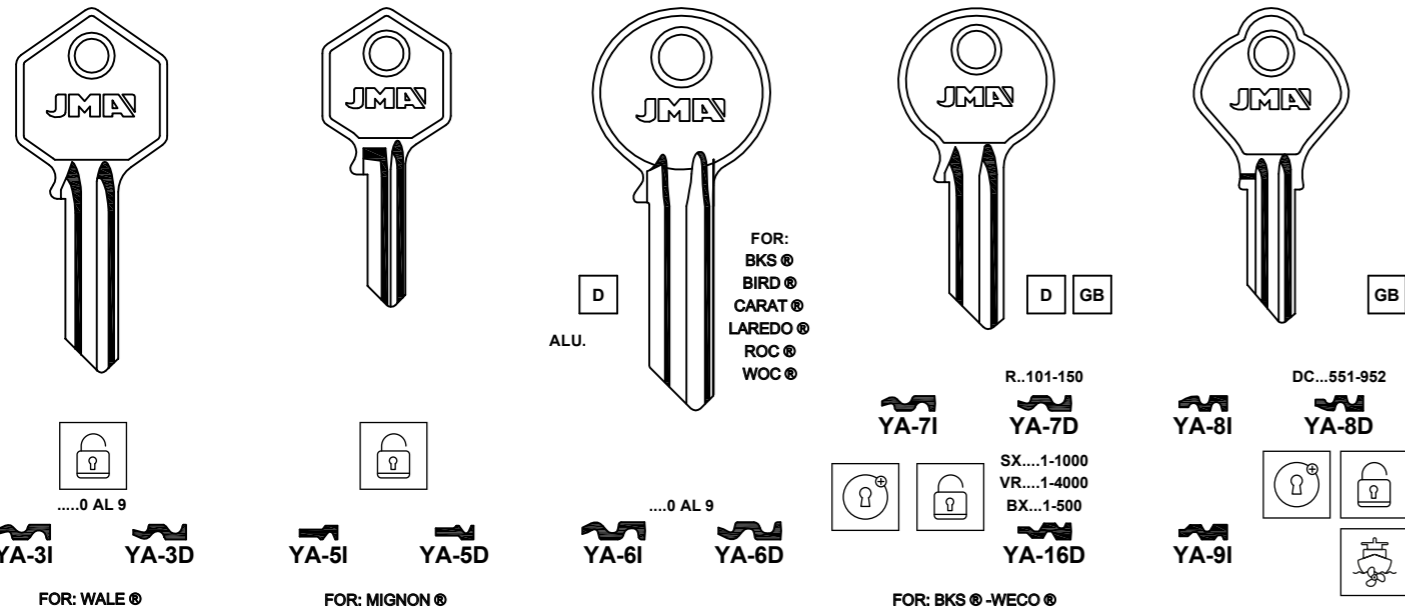

FOR: YALE®

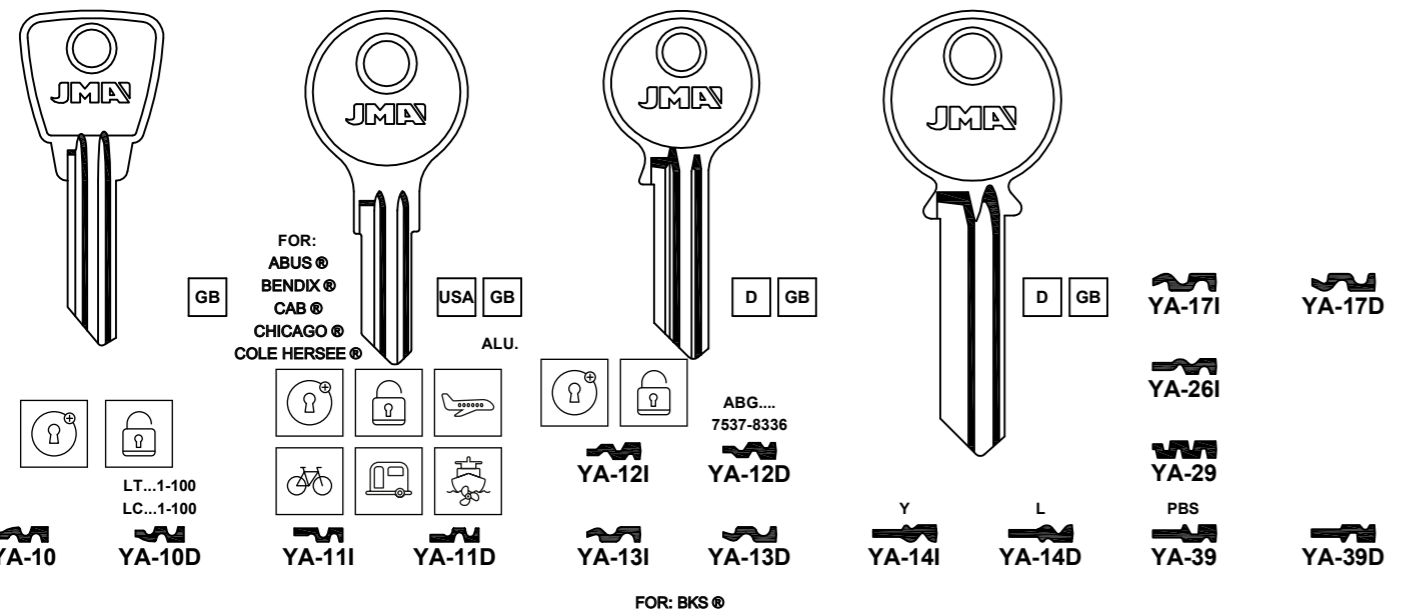

FOR: YALE®

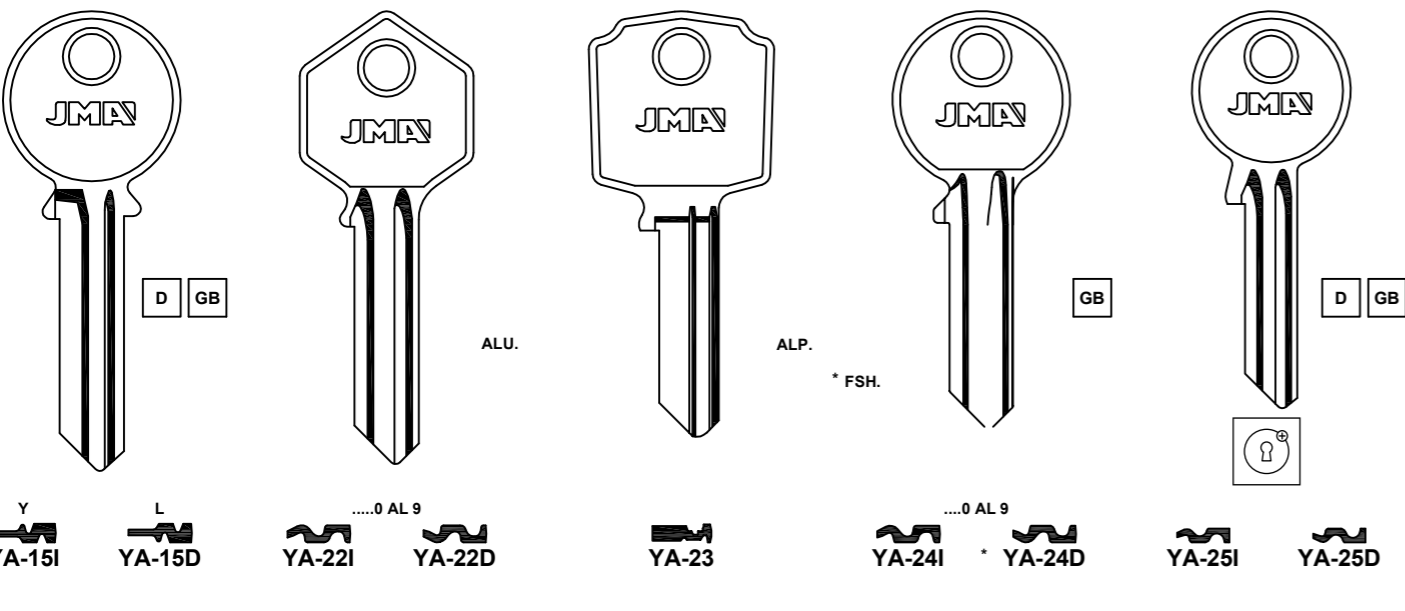

FOR: YALE®

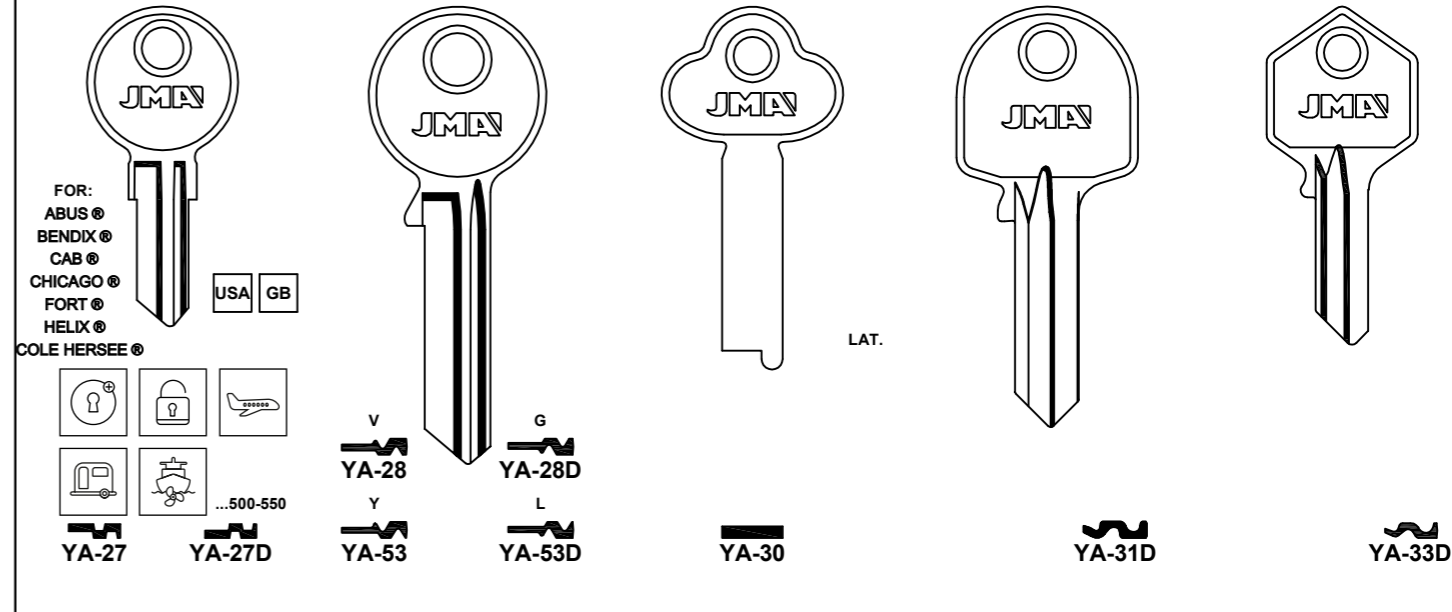

FOR: YALE®

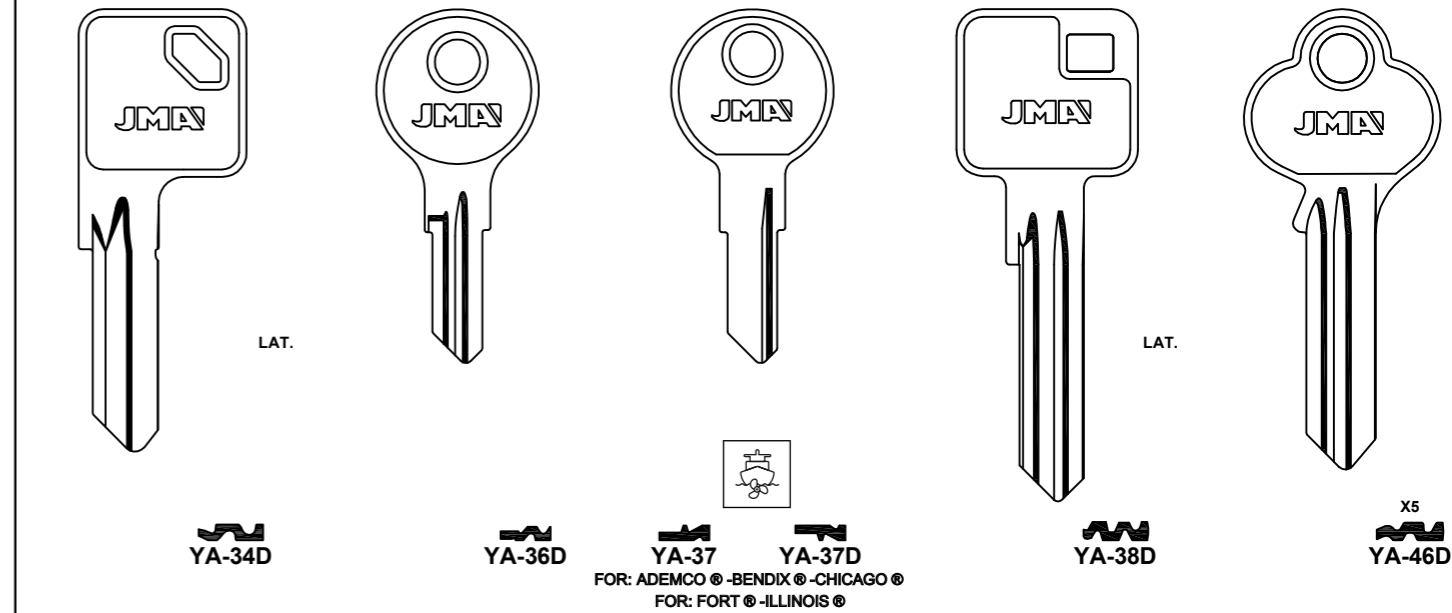

FOR: YALE®

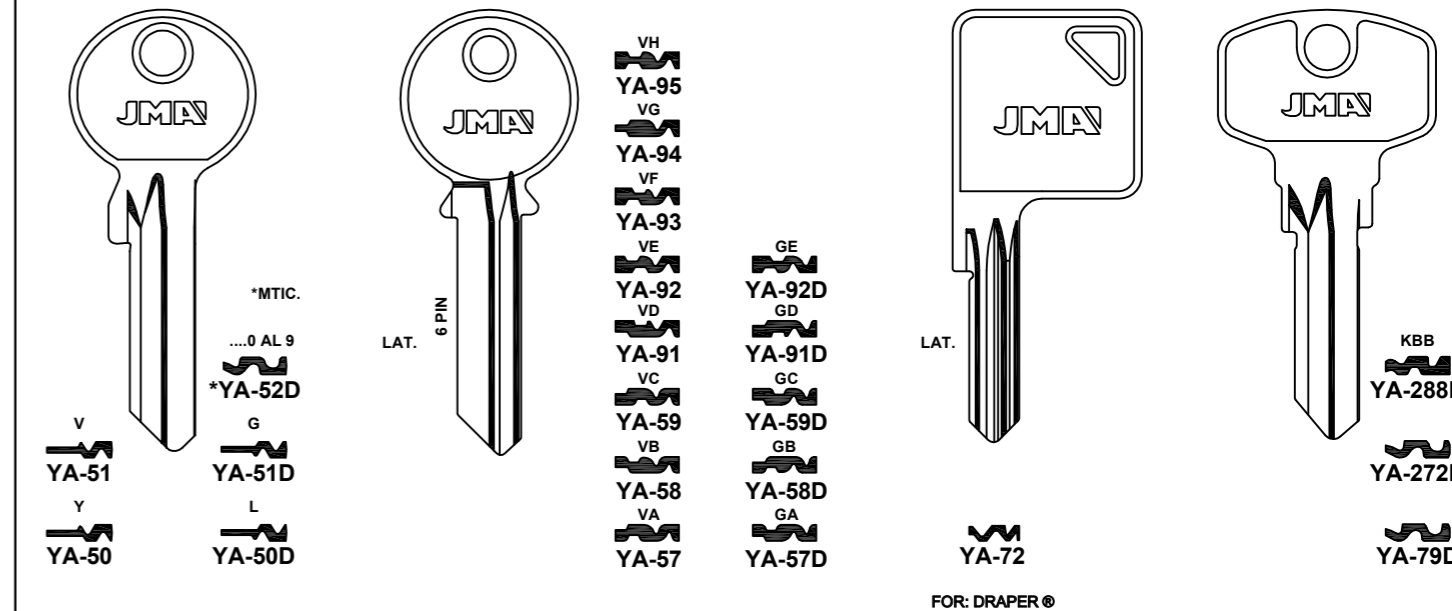

Concerning the marks and commercial denominations see legal warning.
 Concerniente a las marcas y denominaciones comerciales ver aviso legal.
 Marka eta izendapen komertzialiei dagokienez, ikus lege-oharra.
 Concernant les marques et dénominations commerciales voir la note dans l'index.

JMA Opening the future

JMA Opening the future

Beziehen auf die marke und handelsname sehen sie die notiz im Impressum.
 Relativamente às marcas e denominações comerciais, ver aviso legal.
 Ješli chodzí o znaki i nazwy handlowe, patrz Informacje prawne.

FOR: YALE®

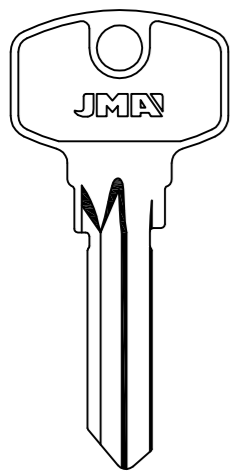

YA-85D

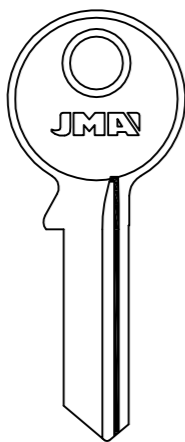

YA-88

FOR: ASSA ABLOY®

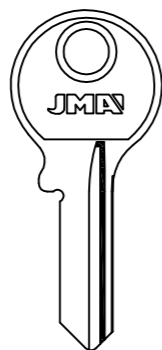

YA-89

FOR: ASSA ABLOY®

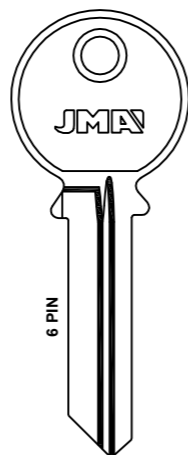

- LG YA-103D
- LF YA-102D
- LE YA-101D
- LD YA-100D
- LC YA-99D
- LB YA-98D
- LA YA-97D



LAT.

6 PIN

FOR: YALE®

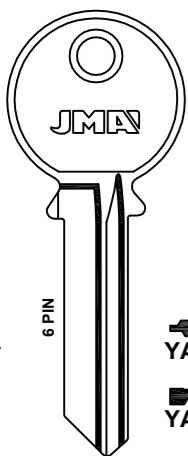

- YG YA-113
- YF YA-112
- YE YA-111
- YB YA-108

LAT.

6 PIN

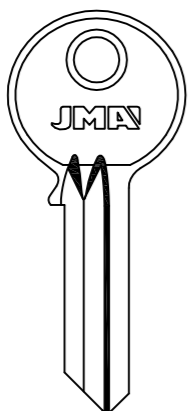

YA-142D

FOR: BKS®

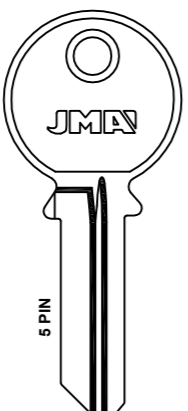

YA-186D

LAT.

5 PIN

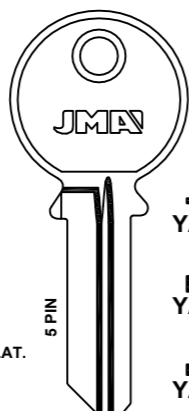

- LG YA-212D
- LE YA-210D
- LD YA-209D
- LC YA-208D
- LA YA-206D

LAT.

5 PIN

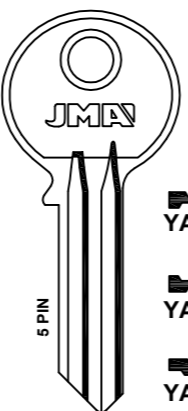

- VF YA-221
- VE YA-220
- VD YA-219
- VB YA-217
- VA YA-216

LAT.

5 PIN

FOR: BKS®

FOR: YALE®

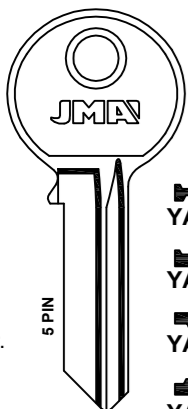

- YH YA-232
- YE YA-229
- YD YA-228
- YC YA-227
- YB YA-226
- YA YA-225

LAT.

5 PIN

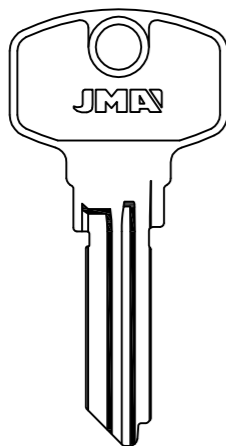

YA-273D

KTM

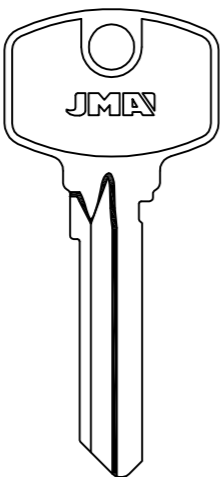

YA-287D

KBA

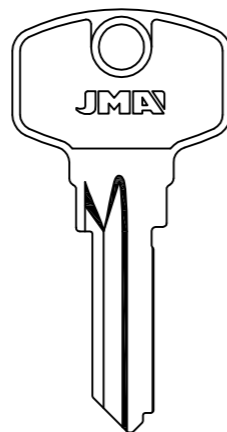

YA-300D

YL5-30D

FOR: YETI®

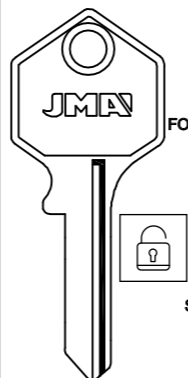

YET-1

YET-14

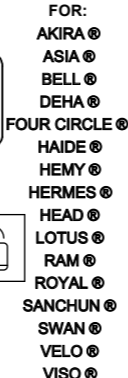

YET-1D

YET-14D

- FOR: AKIRA® ASIA® BELL® DEHA®
- FOUR CIRCLE® HAIDE® HEMY® HERMES® HEAD® LOTUS® RAM® ROYAL® SANCHUN® SWAN® VELO® VISO® WINFIELD® SEZAN®

FOR: BKS®

FOR: YETI®

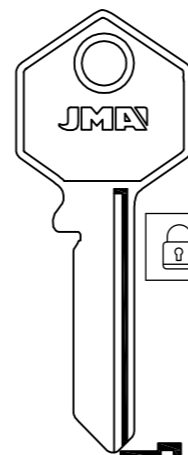

YET-2

YET-16

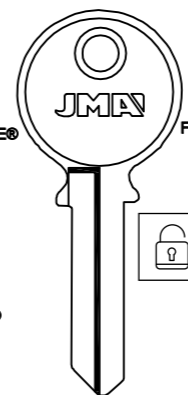

- FOR: AKIRA® ASIA® BELL® DEHA®
- FOUR CIRCLE® HAIDE® HEMY® HERMES® HEAD® LOTUS® RAM® ROYAL® SANCHUN® SWAN® VELO® VISO® WINFIELD® SEZAN®

YET-2D

YET-15

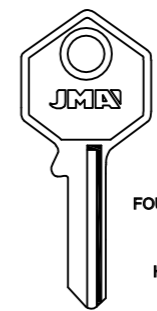

YET-4

YET-4D

- FOR: AKIRA® ASIA® BELL® DEHA®
- FOUR CIRCLE® HAIDE® HEMY® HERMES® HEAD® LOTUS® RAM® ROYAL® SANCHUN® SWAN® VELO® VISO® WINFIELD® SEZAN®

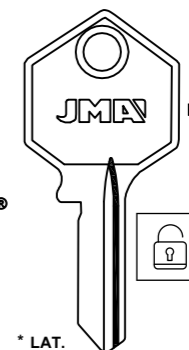

* LAT.

YET-5

YET-6

- FOR: AKIRA® ASIA® BELL® DEHA®
- FOUR CIRCLE® HAIDE® HEMY® HERMES® HEAD® LOTUS® RAM® ROYAL® SANCHUN® SWAN® VELO® VISO® WINFIELD® SEZAN®

YET-5D

YET-6D

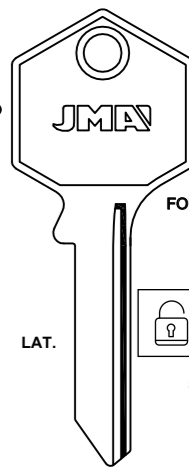

LAT.

YET-7

YET-7D

- FOR: AKIRA® ASIA® BELL® DEHA®
- FOUR CIRCLE® HAIDE® HEMY® HERMES® HEAD® LOTUS® RAM® ROYAL® SANCHUN® SWAN® VELO® VISO® WINFIELD® SEZAN®

FOR: YETI®

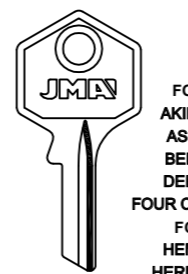

YET-8

YET-8D

- FOR: AKIRA® ASIA® BELL® DEHA®
- FOUR CIRCLE® HEMY® HERMES® HEAD® LOTUS® RAM® ROYAL® SANCHUN® SWAN® VELO® VISO® WINFIELD® SEZAN®



YET-9

YET-13

- FOR: AKIRA® ASIA® BELL® DEHA®
- FOUR CIRCLE® HAIDE® HEMY® HERMES® HEAD® LOTUS® RAM® ROYAL® SANCHUN® SWAN® VELO® VISO® WINFIELD® SEZAN®

YET-9D

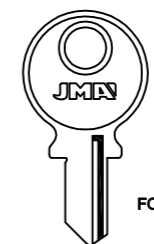

YET-10

YET-10D

- FOR: AKIRA® ASIA® BELL® DEHA®
- FOUR CIRCLE® HAIDE® HEMY® HERMES® HEAD® LOTUS® RAM® ROYAL® SANCHUN® SWAN® VELO® VISO® WINFIELD® SEZAN®

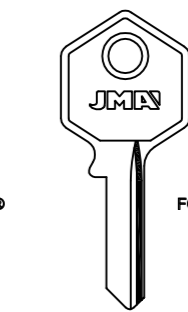

YET-11

YET-11D

- FOR: AKIRA® ASIA® BELL® DEHA®
- FOUR CIRCLE® HAIDE® HEMY® HERMES® HEAD® LOTUS® RAM® ROYAL® SANCHUN® SWAN® VELO® VISO® WINFIELD® SEZAN®

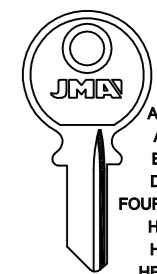

YET-12

- FOR: AKIRA® ASIA® BELL® DEHA®
- FOUR CIRCLE® HAIDE® HEMY® HERMES® HEAD® LOTUS® RAM® ROYAL® SANCHUN® SWAN® VELO® VISO® WINFIELD® SEZAN®

FOR: YETI®

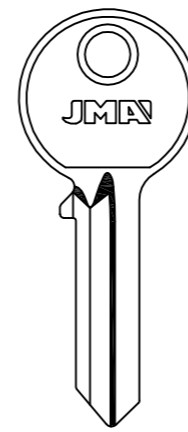

YET-17D

FOR: LOB® -EXPRES® -YARDENI® -YARD®

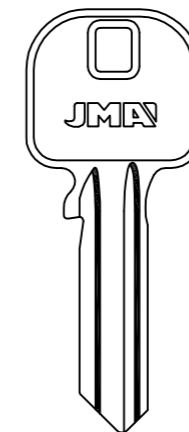

YET-18

YET-18D

FOR: LOB®

FOR: YUN HUAN®

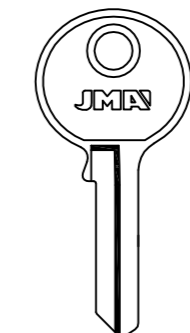

YUH-1D

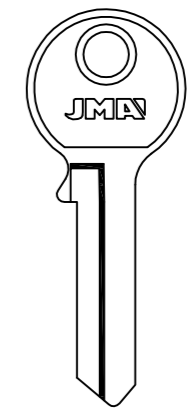



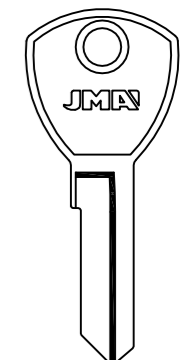





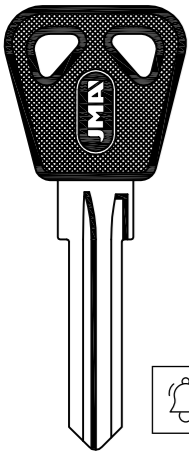
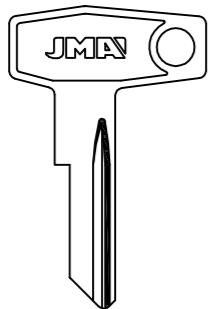
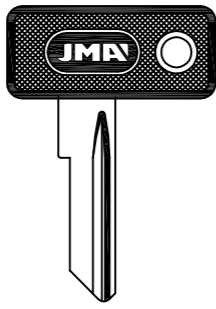
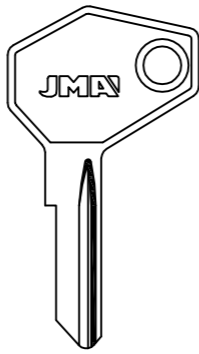
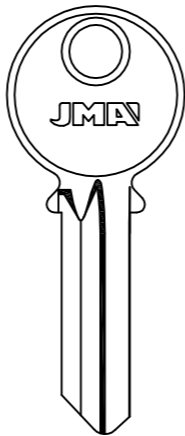

YUH-2D



YUH-3D

Concerning the marks and commercial denominations see legal warning.
 Concerniente a las marcas y denominaciones comerciales ver aviso legal.
 Marka eta izendapen komertzialiei dagokienez, ikus lege-oharra.
 Concernant les marques et denominations commerciales voir la note dans l'index.



FOR: YWS®	FOR: ZADI®			FOR: ZENI®
				
				
1-16255001-6278 E...1-7101-16255001-6278 E...1-7101-16255001-6278 E...1-710	
				
FOR: ABUS®	FOR: BRETER®	FOR: BRETER®	FOR: BRETER®	



DIMPLE KEYS

Llaves de puntos
Puntuen giltzak

Clés à points
Bohrmuldenschlüssel

Chaves de pontos
Klucze nawiercane

Concerning the marks and commercial denominations see legal warning.
Concerniente a las marcas y denominaciones comerciales ver aviso legal.
Marka eta izendapen komertzialiei dagokienez, ikus lege-oharra.
Concernant les marques et dénominations commerciales voir la note dans l'index.

FOR: ABC®

ALP. ALP.

FOR: BAGEM®

FOR: ABUS®

LAT. LAT. LAT. LAT. LAT. LAT.

EC 75

EXTRA CLASSE

FOR: CISA® -BRICARD®

FOR: AGB®

LAT. LAT. LAT. LAT. LAT. LAT.

FOR: SCUDO®

SCUDO 5000

SCUDO 5000

SCUDO 5000

SCUDO 5000

SCUDO 5000

FOR: AHRAM®

LAT. LAT.

FOR: ABUS®

LAT. LAT. LAT.

EC550

D20

EC-S

FOR: COLOMENCA® -FB®

FOR: SERRALLER® -TERCA®

FOR: AGA®

LAT. LAT.

FOR: COLLAIX®

FOR: AMIG®

LAT. LAT. LAT. LAT. LAT. LAT. LAT.

5000

2500

18080

10000E / 10580

MOD.10000

FOR: GMB®

FOR: AMIG®

LAT.

MOD.20000

FOR: APECS®

LAT. LAT. LAT. LAT. LAT.

FOR: APEX® -APEKS®

FOR: AMIG® -BYP® -C.V.C.®

FOR: FTH® -APEX® -APEKS®

FOR: APEX® -APEKS®

FOR: APEX® -APEKS®

FOR: AGA®

LAT. LAT. LAT. LAT. LAT. LAT. LAT. LAT. LAT. LAT.

FOR: CASAS®

Concerning the marks and commercial denominations see legal warning.
 Concerniente a las marcas y denominaciones comerciales ver aviso legal.
 Marka eta izendapen komertzialiei dagokienez, ikus lege-oharra.
 Concernant les marques et denominations commerciales voir la note dans l'index.



Beziehen auf die marke und handelsname sehen sie die notiz im Impressum.
 Relativamente às marcas e denominações comerciais, ver aviso legal.
 Jeśli chodzi o znaki i nazwy handlowe, patrz Informacje prawne.

FOR: ASHICO®

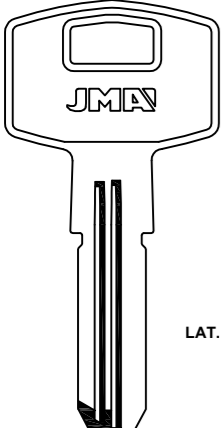

LAT.



ASH-2

FOR: AXA®

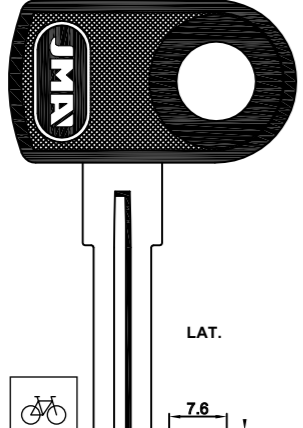

LAT.

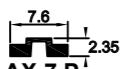

AX-7.P

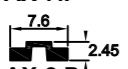

AX-2.P

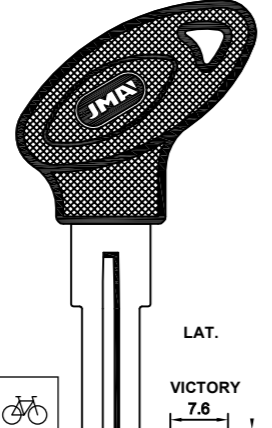

LAT.



AX-2.P1

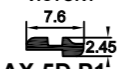

VICTORY



AX-5D.P1

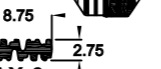

AX-6

FOR: BUFFO®

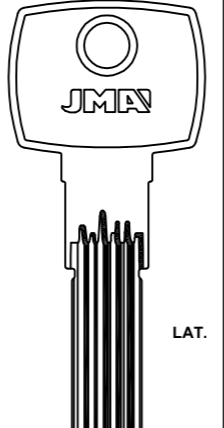

LAT.

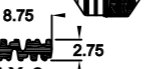

AX-6

FOR: AZBE®

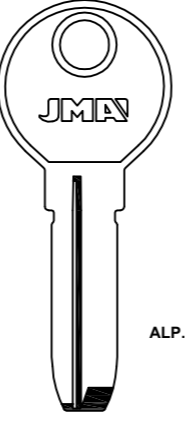

ALP.

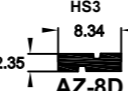

AZ-8D

FOR: BEY®

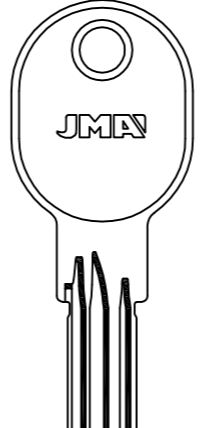

LAT.



BEY-1D

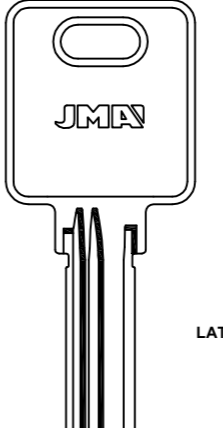

LAT.

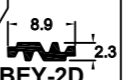

BEY-2D

FOR: WALE®

FOR: PHILLIPS® -YALTRES®

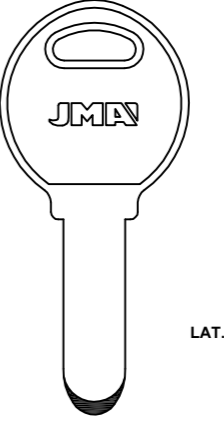

LAT.

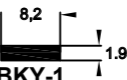

BKY-1

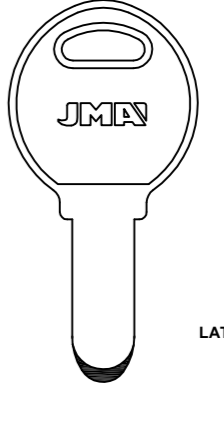

LAT.



BKY-2

FOR: BRICARD®

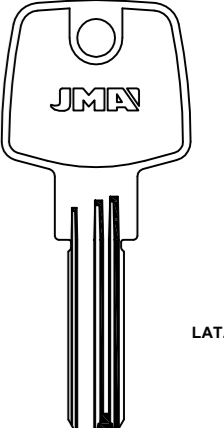

LAT.

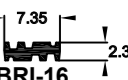

BRI-16

FOR: AZBE®

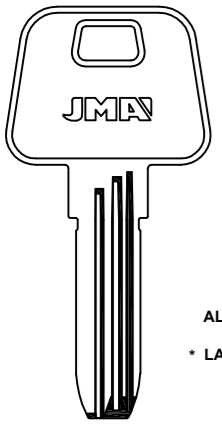

ALP.
* LAT.

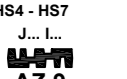

AZ-9

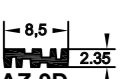

AZ-9D

FOR: CAVERS® -CENTURION® -ZAIN®

HSE - A14
AZ-40

HSE - A13
AZ-39

HS7
AZ-29

HS2
2... 3...
AZ-12

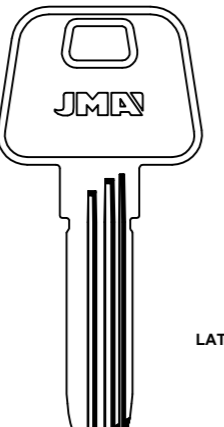

LAT.

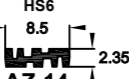

AZ-14

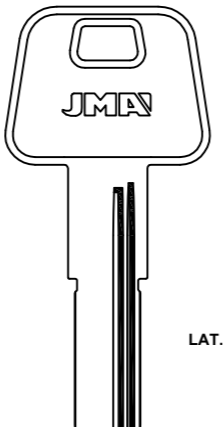

LAT.

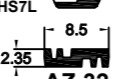

AZ-32

FOR: BAGEM®

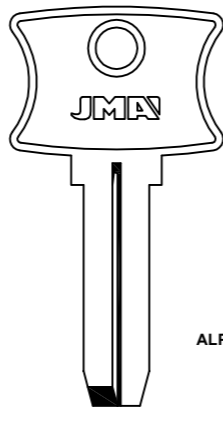

ALP.

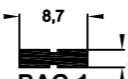

BAG-1

FOR: BRICARD®

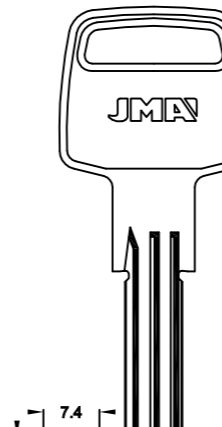

LAT.



BRI-25

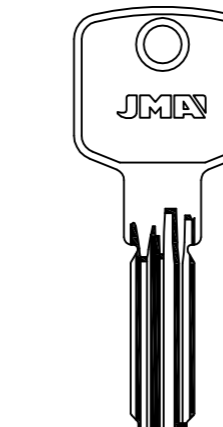

LAT.



BRI-27



BRI-26

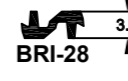

BRI-28

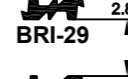

BRI-29

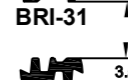

BRI-31

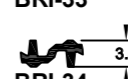

BRI-33



BRI-34

FOR: STANDERS®

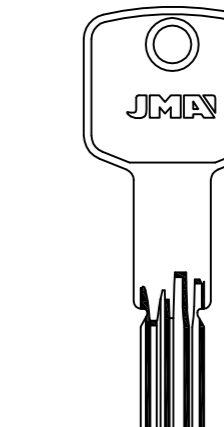

LAT.

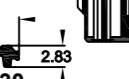

BRI-30

FOR: BRISANT®

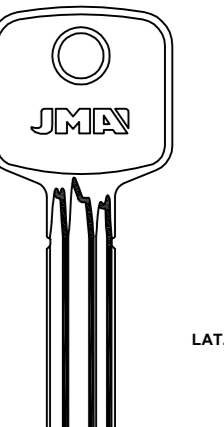

LAT.



BRN-1D

FOR: ULTION® -FEDERAL® -HUGO®

FOR: BAODEAN®

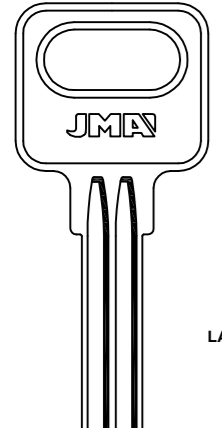

LAT.



BDA-1

FOR: BTV®

FOR: BASI®

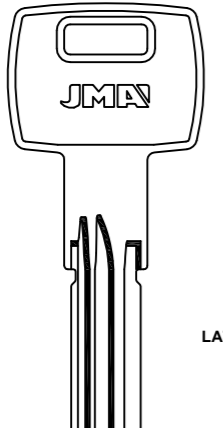

LAT.



BAI-8D

FOR: GEVY® -SATURN® -AMIG®
FOR: LEGALLAIS®

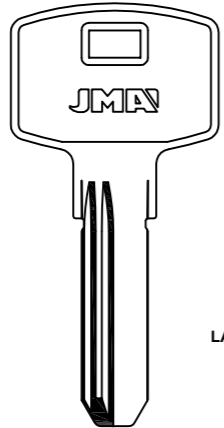

LAT.

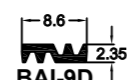

BAI-9D

FOR: TOVER®

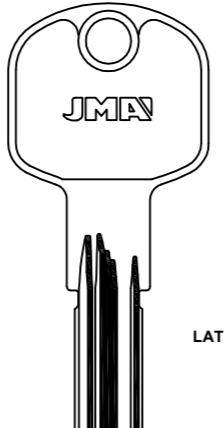

LAT.

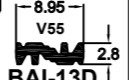

BAI-13D

FOR: BATON®

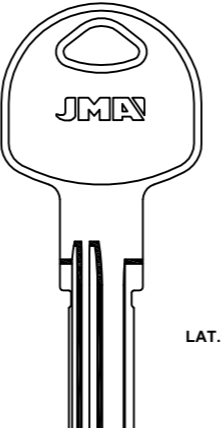

LAT.

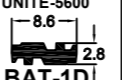

BAT-1D

FOR: BULAT®

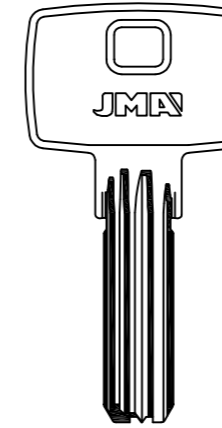

LAT.

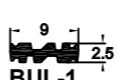

BUL-1

FOR: FTH® - THIRARD®

FOR: BURG®

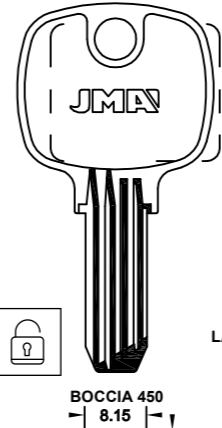

LAT.

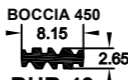

BUR-43

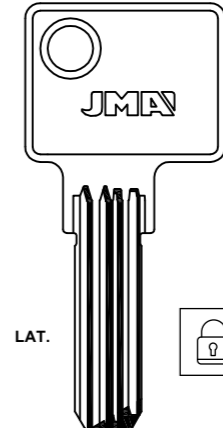

LAT.

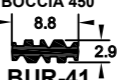

BUR-33

FOR: BURG WACHTER®

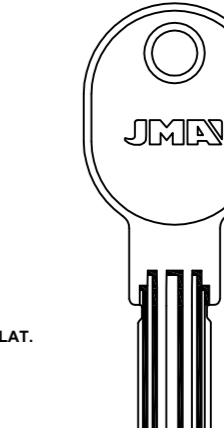

LAT.

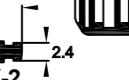

BUR-41

FOR: BURG WACHTER®

FOR: CAYS®

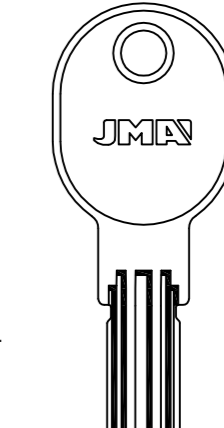

LAT.



CAY-2

FOR: ISEO®

FOR: CES®

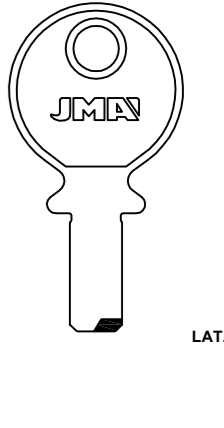

LAT.

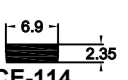

CE-114

Concerning the marks and commercial denominations see legal warning.
 Concerniente a las marcas y denominaciones comerciales ver aviso legal.
 Marka eta izendapen komertzialiei dagokienez, ikus lege-oharra.
 Concernant les marques et denominations commerciales voir la note dans l'index.

JMA® Opening the future

JMA® Opening the future

Beziehen auf die Marke und Handelsname sehen Sie die Notiz im Impressum.
 Relativamente às marcas e denominações comerciais, ver aviso legal.
 Jeśli chodzi o znaki i nazwy handlowe, patrz Informacje prawne.



FOR: CHUBB®

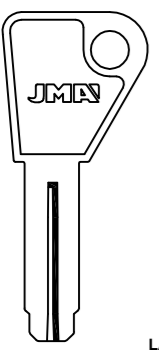

FOR: AVA® -CHUBB®

FOR: CISA®

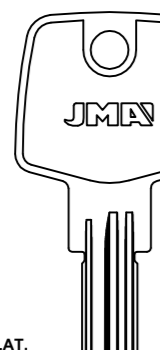

LAT.

7.35
2.35
CI-14

A/AZIZA/Z.....
000001-030198

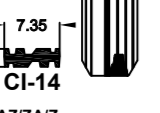

CI-17

FOR: ABUS® -ASTRAL® -BRICARD®

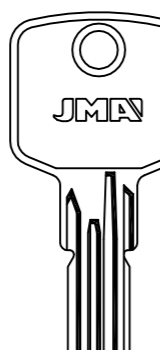

LAT.

8.2
2.85
CI-21



CI-25



CI-26



CI-30



CI-31



CI-32



CI-33



CI-35



CI-56



CI-59



CI-60



CI-67



CI-71



CI-72



CI-73



CI-81



8.2
2.85
CI-48

FOR: ABUS® -GERDA®

FOR: DEKABA®

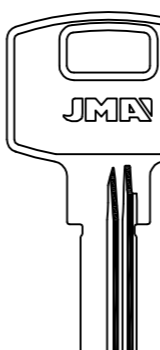

LAT.

7.2
2.5
DEK-4

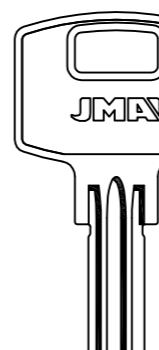

LAT.

DEK-11



LAT.

C42
8.6
2.5
DEK-16

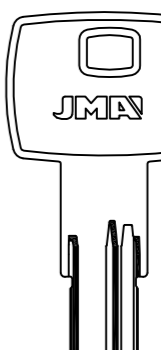

LAT.

8.65
2.3
DEK-17

FOR: MAUER®

FOR: MAUER® -AXA®

FOR: DELCA®

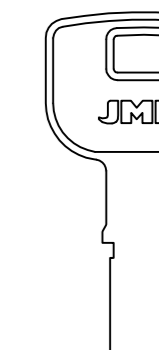

LAT.

DLC-2



9
2.4
DLC-1

FOR: GEVY®

FOR: CISA®

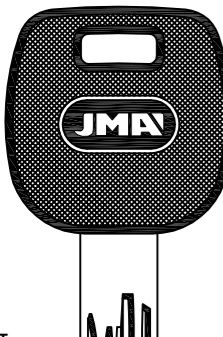

LAT.



CI-76.P

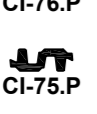

CI-75.P

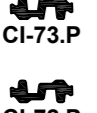

CI-73.P

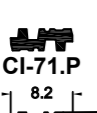

CI-72.P



CI-71.P



8.2
2.85
CI-48.P

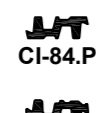

CI-84.P

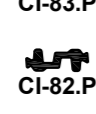

CI-83.P

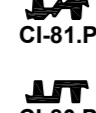

CI-82.P



CI-81.P



CI-80.P



CI-79.P



CI-78.P

FOR: ABUS®

FOR: CORBIN®



LAT.

9.4
2.9
COR-37



LAT.

9.4
2.9
COR-77

FOR: IFAM®



LAT.

8.2
2.85
CI-57

FOR: DELCA®

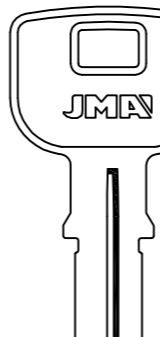

LAT.

9
2.45
DLC-3

FOR: GEVY®

FOR: DELTA®

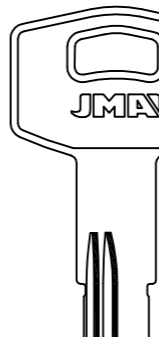

LAT.

8.6
2.3
DLT-1D

FOR: MOREAUX®

FOR: DIERRE®

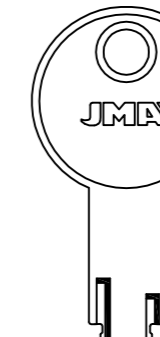

LAT.

6.8
2.57
DR-1

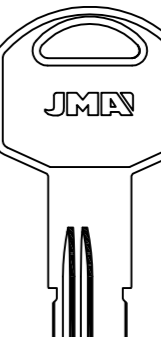

LAT.

9.7
AS6
2.8
DR-2D

FOR: CORBIN® -EMHART®

FOR: DOM®

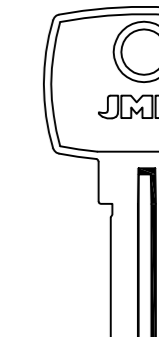

LAT.

ALP.
LAT.

8.82
2.2
DOM-17I

FOR: CORBIN® -EMHART®

FOR: CVL®

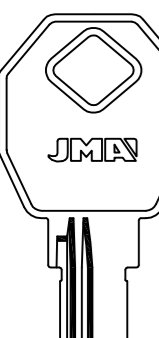

LAT.

.....IC
8-7-6-5-4-3
8.9
2.4
CVL-9D

FOR: DAF®

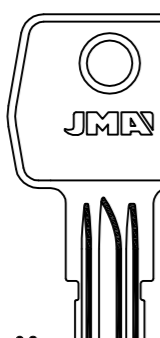

LAT.

9.2
2.8
DAF-2



LAT.

DAF-3D



DAF-4D

FOR: CARDO®

FOR: DASS®

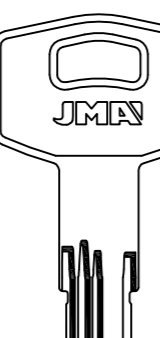

LAT.

8.7
H2.3
2.3
DAS-1D

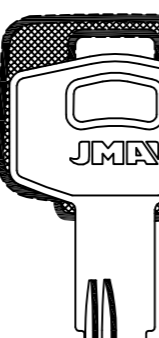

LAT.

ORIGINAL DASS

8.6
2.3
DLT-1D

FOR: DEKABA®

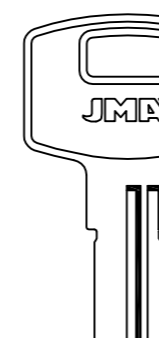

LAT.

8.4
2.45
DEK-3

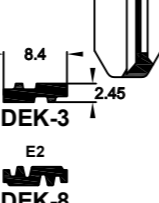

E2
DEK-8

FOR: MAUER® -M&D® -ROTO®

FOR: DOM®

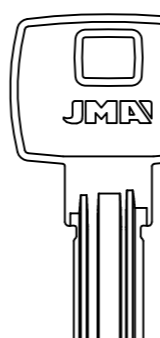

ALP.

8.9
2.1
DOM-22

FOR: ARCU®

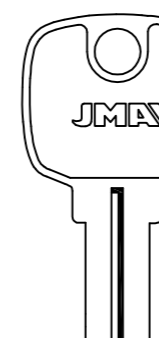

ALP.

8.4
2.4
DOM-30

FOR: MOREAUX®

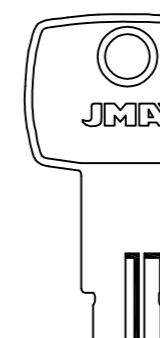

LAT.

8.9
IX 5
2.35
DOM-31

FOR: CORBIN® -EMHART®

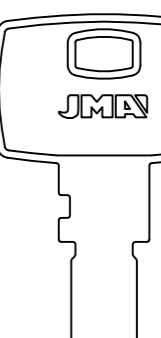

ALP.

8.5
2.3
DOM-32

FOR: CORBIN® -EMHART®

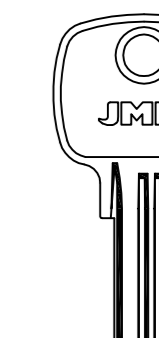

LAT.

7.1
2Y
2
DOM-33

Concerning the marks and commercial denominations see legal warning.
 Concerniente a las marcas y denominaciones comerciales ver aviso legal.
 Marka eta izendapen komertzialiei dagokienez, ikus lege-oharra.
 Concernant les marques et dénominations commerciales voir la note dans l'index.

JMA® Opening the future

JMA® Opening the future

Beziehen auf die Marke und Handelsname sehen Sie die Notiz im Impressum.
 Relativamente às marcas e denominações comerciais, ver aviso legal.
 Jeśli chodzi o znaki i nazwy handlowe, patrz Informacje prawne.



FOR: DOM®

ALP. LAT. LAT. ALP. ALP.

DOM-34: 7.35, 2.05
DOM-39: 7.1, 2.3
DOM-43: 7.1, 2.3
DOM-56D: 9.4, 2.3
DOM-63D: 9.4, 2.3
DOM-B1: 9, 2.5
DOM-B2: 9, 2.5
DOM-B6: 9, 4.1

FOR: CORBIN®-STS®

FOR: DOMUS® **FOR: ELZETT®** **FOR: EUROLOCKS®** **FOR: EZCURRA®**

LAT. LAT. LAT. LAT. ALP. LAT. ALP. LAT. LAT.

DO-3: 7, 2.2
DO-4: 7, 2.2
ELZ-10: 8.9, 2.8
ELZ-10D: 8.9, 2.8
ELZ-13: 9.4, 2.85
EU-12: 7.6, 2.9
EZ-DS10: 7.45, 2.3
EZ-DS10E: 7.45, 2.3
TD-25: 8.5, 2.35

FOR: HOBBY®-HYMER®

FOR: EZCURRA® **FOR: FAC®**

LAT. WColor (LAT.) ALP. LAT. LAT.

EZ-DS15: 7.45, 2.3
EZ-DS15R: 7.45, 2.3
FAC-19: 8.6, 2.3
FAC-23: 8.9, 2.35
FAC-24: 8.9, 2.35

FOR: FAC® **FOR: FAVOUR®** **FOR: FAYN®** **FOR: FCV®** **FOR: FERONERIA®**

LAT. LAT. LAT. LAT. LAT.

FAC-25: 8.6, 2.3
FAV-1D: 8.8, 2.35
FAV-2: 8.8, 2.35
FAY-1D: 8.35, 2.25
FV-3: 8.9, 2.75
FER-2D: 8.6, 2.4

FOR: TEICOCIL®

FOR: KFV®-VBH®

FOR: VF (VEROFER)®

FOR: F.F.® **FOR: FTH®**

LAT. ALP. ALP. LAT. LAT.

FF-13: 9.4, 2.7
TD-7: 8.6, 2.85
TD-16: 8.85, 2.95
TD-23: 7.9, 2.95
TD-30: 8.6, 2.35

FOR: FACCHINETTI®

FOR: CODEM®-TOVER®-YALTRES®-VACHETTE®

FOR: IFAM®-KARO®-THIRARD®

FOR: ATLANTIC®

FOR: THIRARD®

FOR: FTH® **FOR: GERDA®** **FOR: GEVY®**

LAT. LAT. LAT. LAT. LAT.

TD-26D: 8.7, 2.35
TD-29: 8.65, 2.8
GDA-1.P: 8.66, 2.8
GDA-4D: 8.7, 2.45
GEV-3D: 8.9, 2.8

FOR: SP®-THIRARD®

FOR: THIRARD®

FOR: MOTTURA®

Concerning the marks and commercial denominations see legal warning.
 Concerniente a las marcas y denominaciones comerciales ver aviso legal.
 Marka eta izendapen komertzialiei dagokienez, ikus lege-oharra.
 Concernant les marques et dénominations commerciales voir la note dans l'index.

JMA® Opening the future

JMA® Opening the future

Beziehen auf die Marke und Handelsname sehen Sie die Notiz im Impressum.
 Relativamente às marcas e denominações comerciais, ver aviso legal.
 Jeśli chodzi o znaki i nazwy handlowe, patrz Informacje prawne.



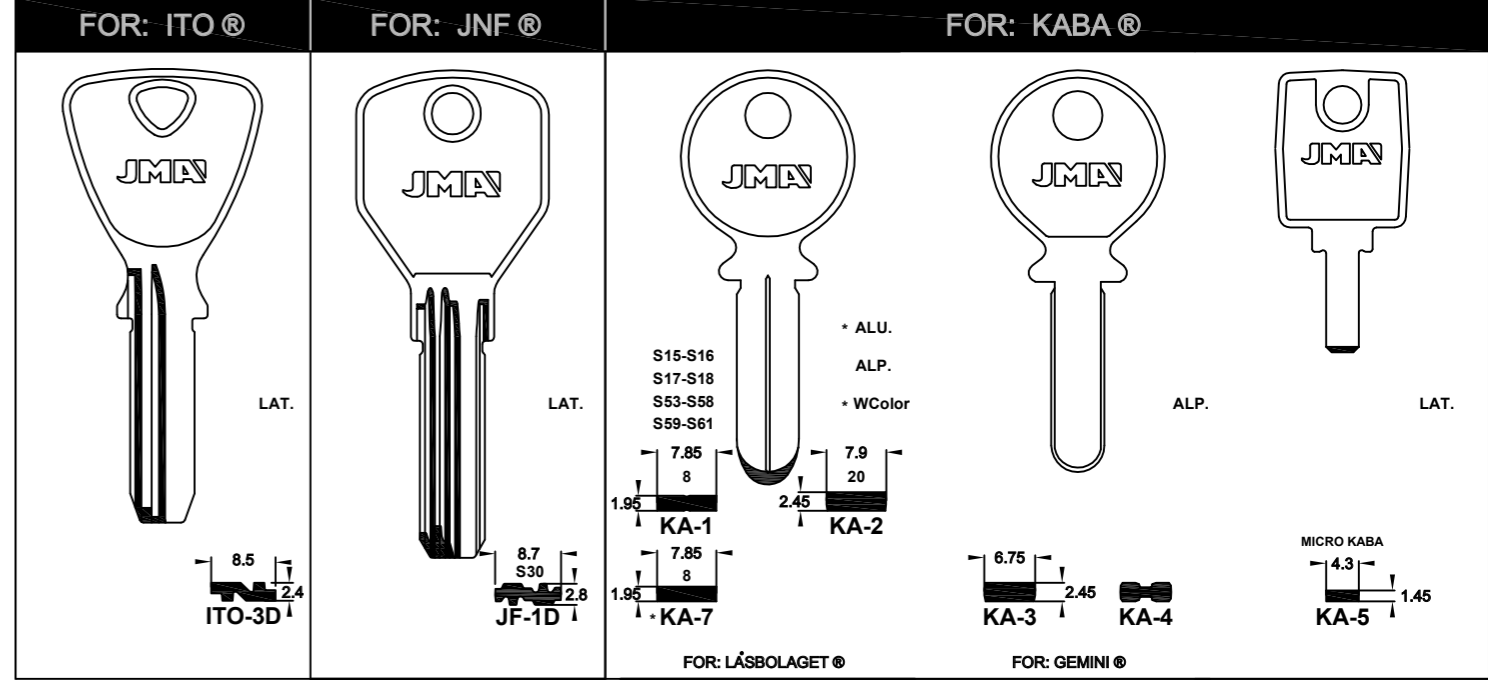
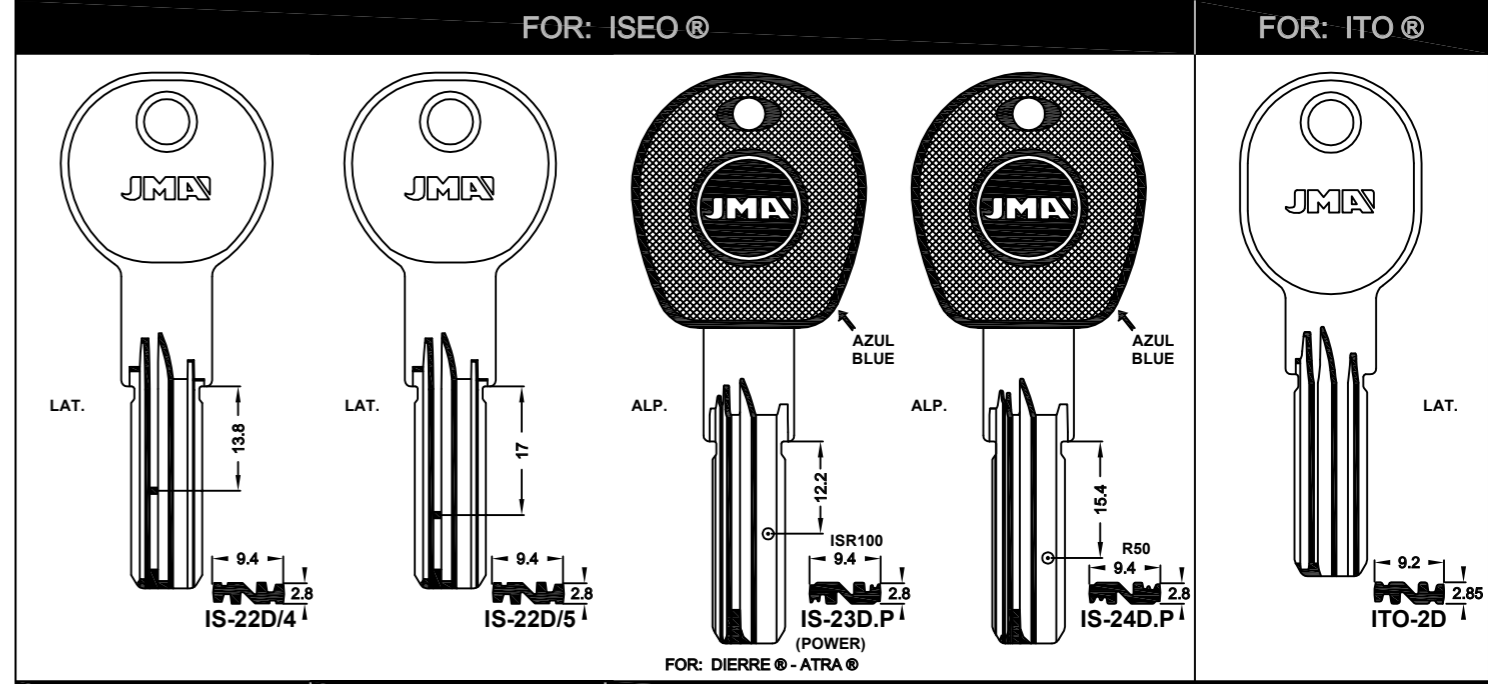
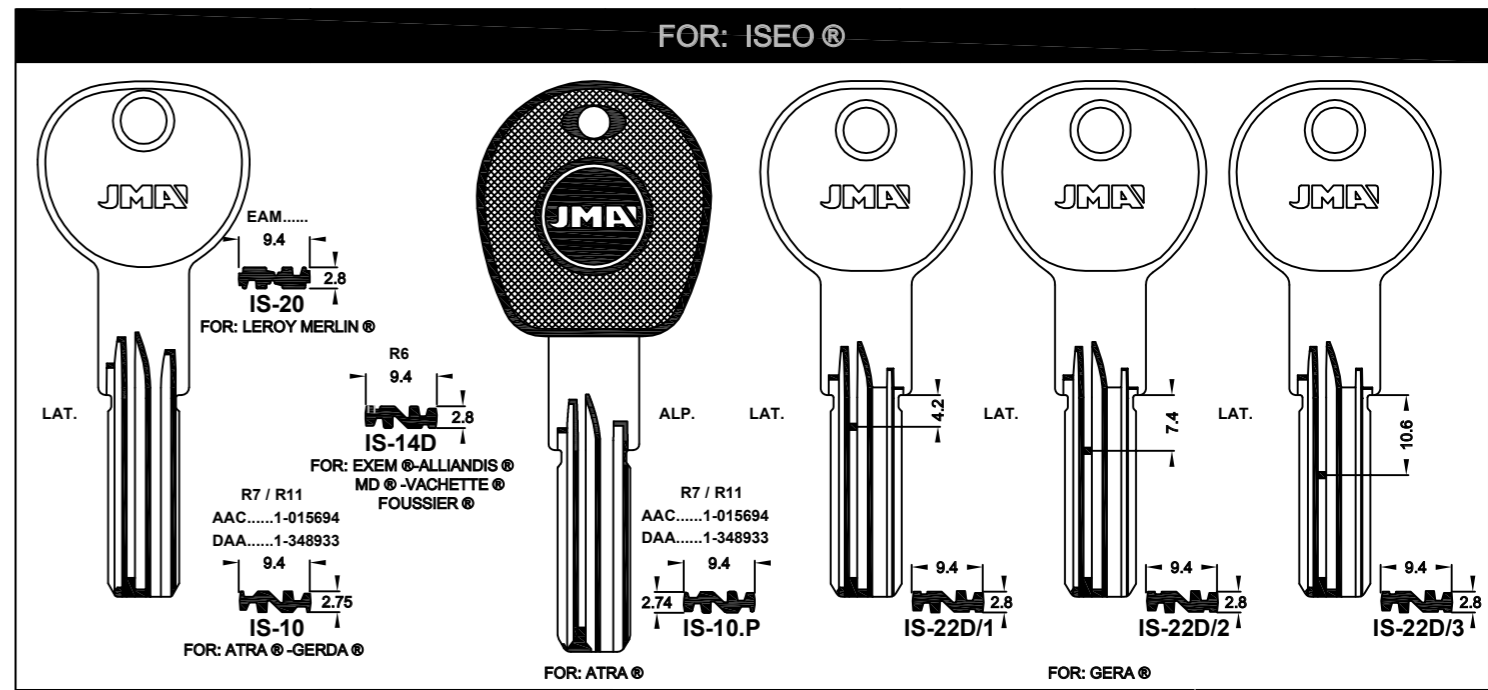
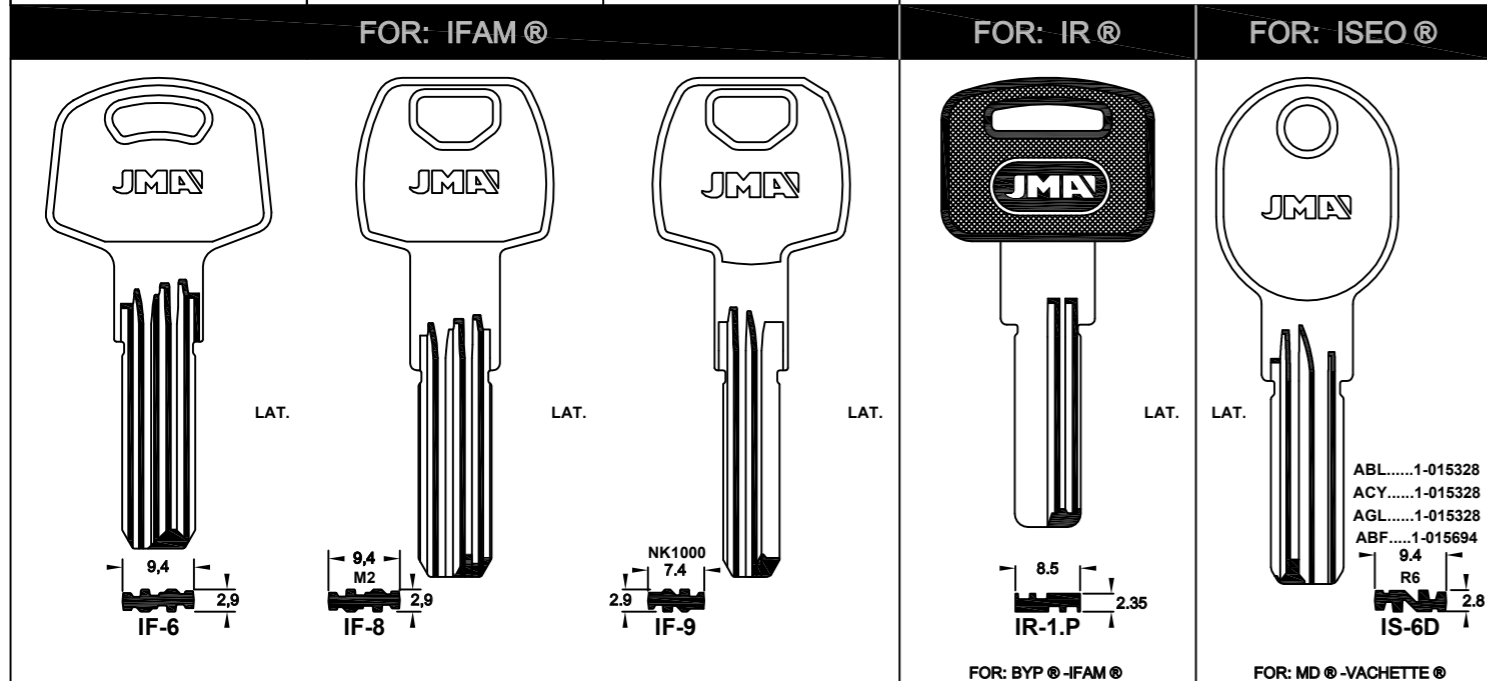
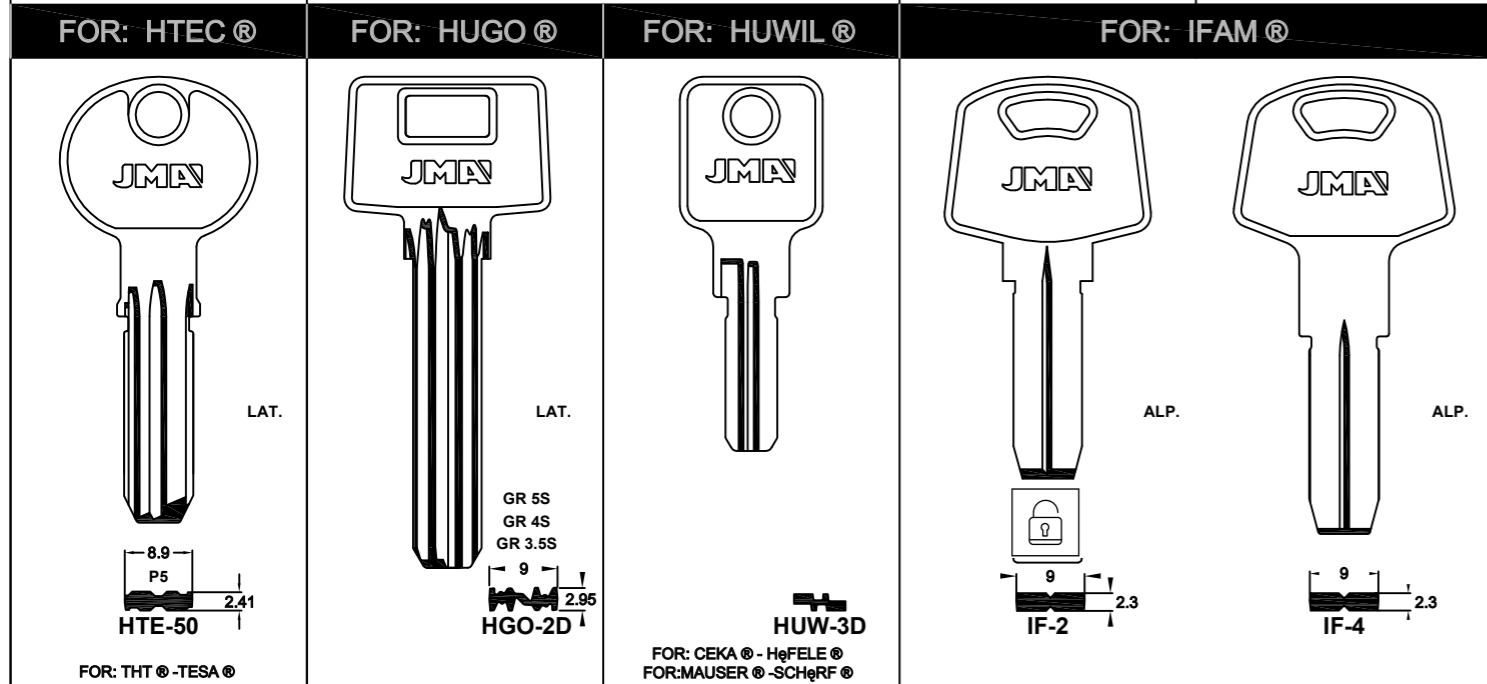
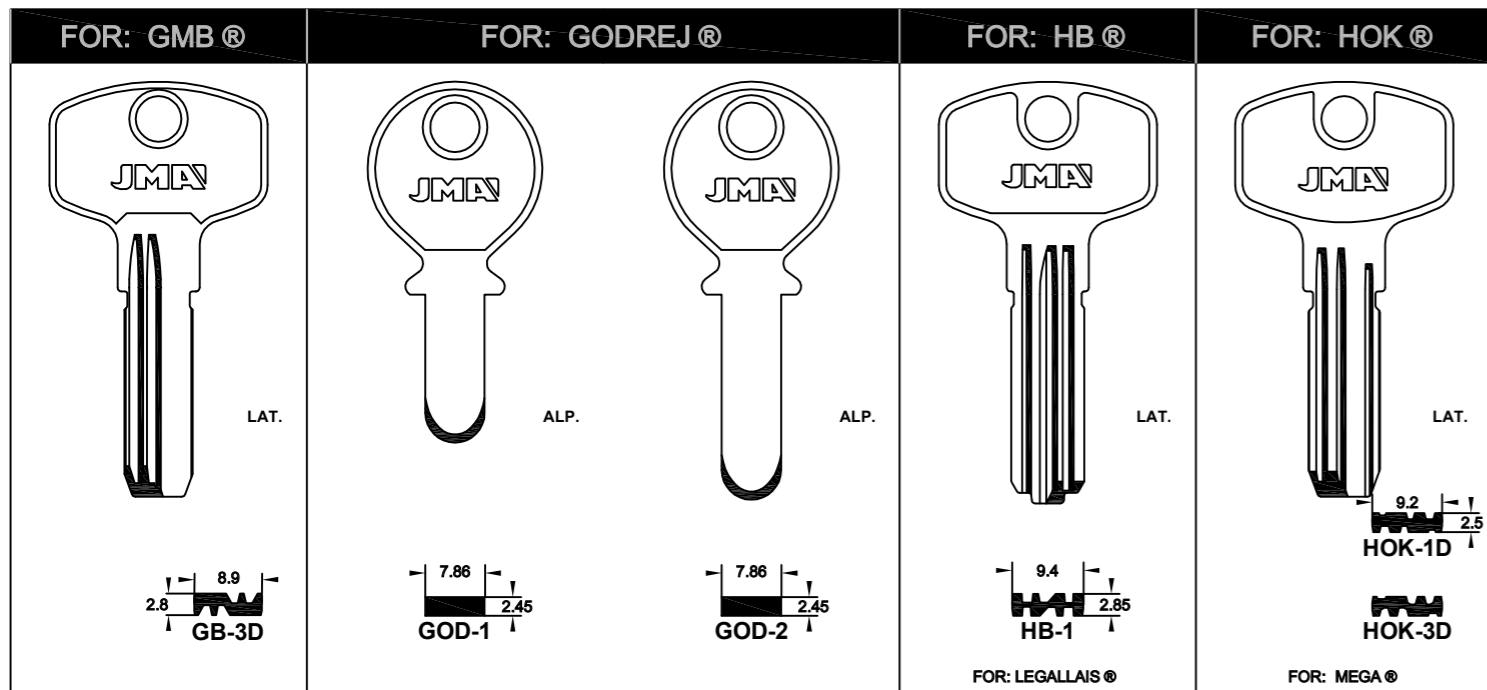

Concerning the marks and commercial denominations see legal warning.
 Concerniente a las marcas y denominaciones comerciales ver aviso legal.
 Marka eta izendapen komertzialiei dagokienez, ikus lege-oharra.
 Concernant les marques et dénominations commerciales voir la note dans l'index.

JMA Opening the future

JMA Opening the future

Beziehen auf die Marke und Handelsname sehen Sie die Notiz im Impressum.
 Relativamente às marcas e denominações comerciais, ver aviso legal.
 Jeśli chodzi o znaki i nazwy handlowe, patrz Informacje prawne.



FOR: KABA®

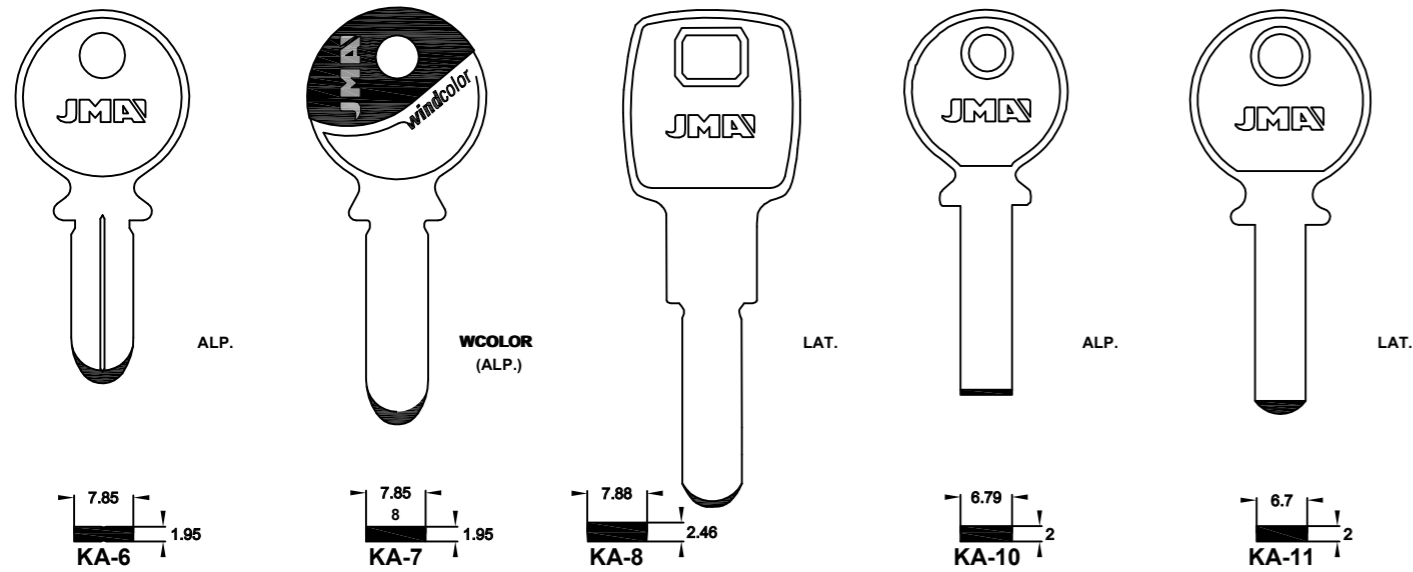

FOR: LASBOLAGET®

FOR: KALE®

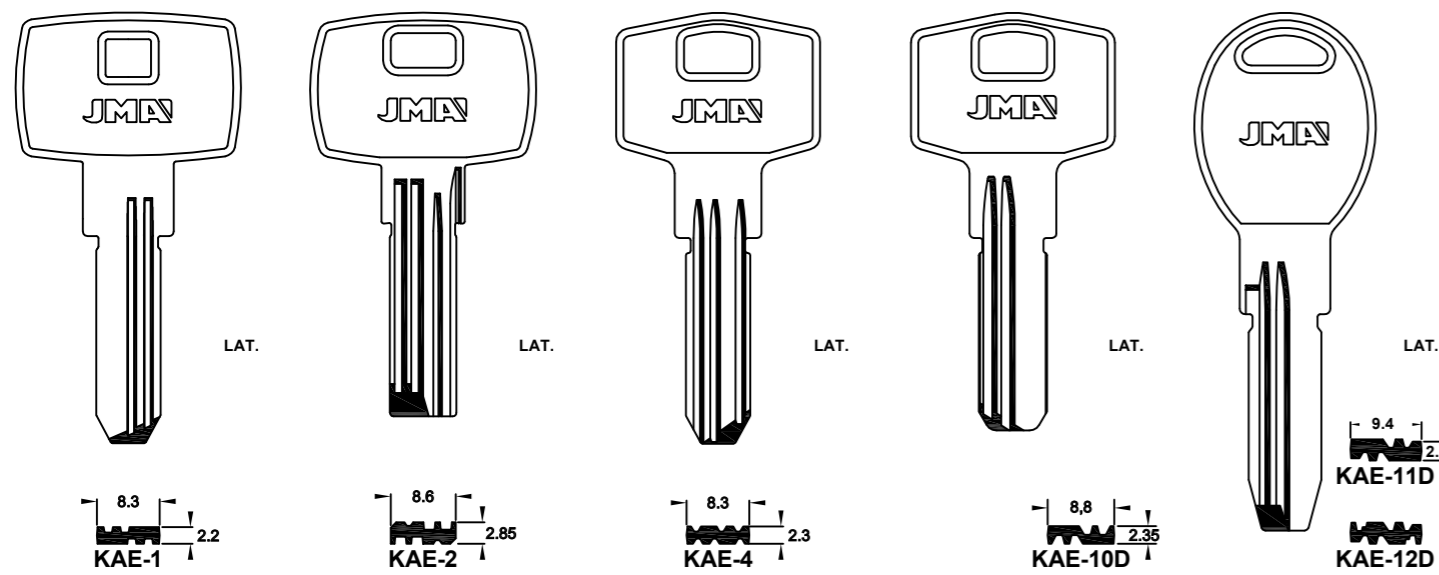

FOR: JIS®

FOR: FAC®-ROTO®

FOR: KALE®

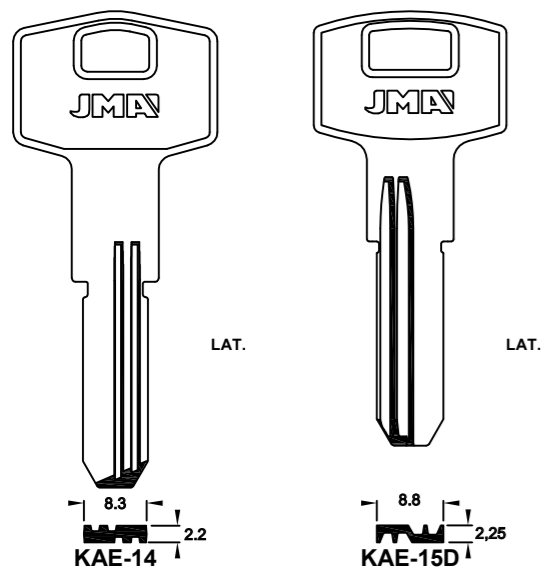

FOR: KESO®

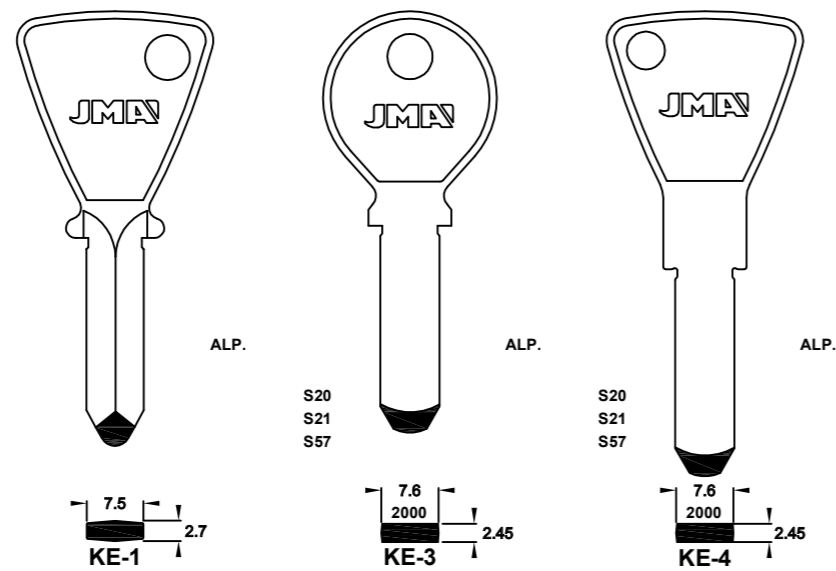

FOR: JPM®

FOR: KESO®

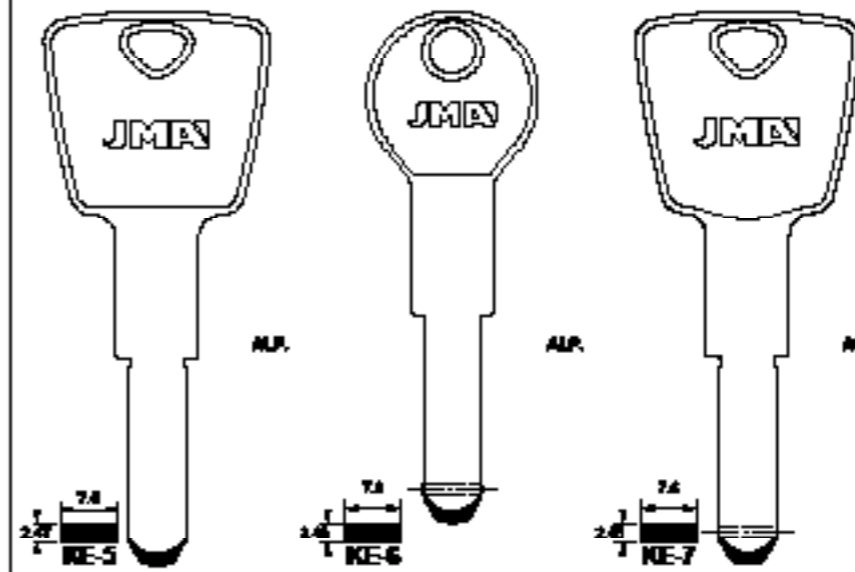

FOR: LAPERCHE®

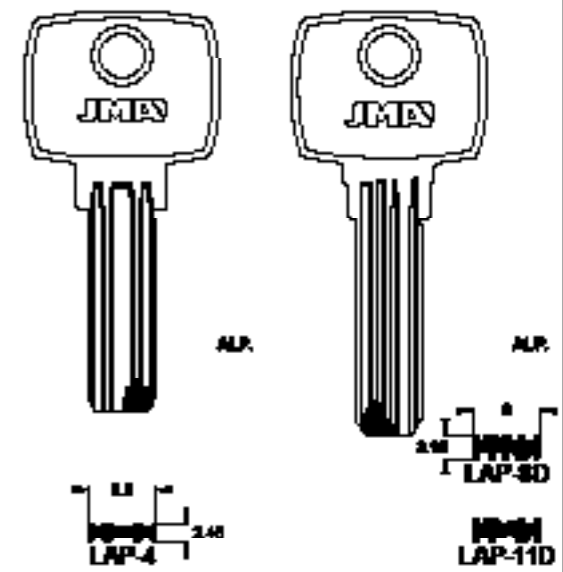

FOR: LAPERCHE®

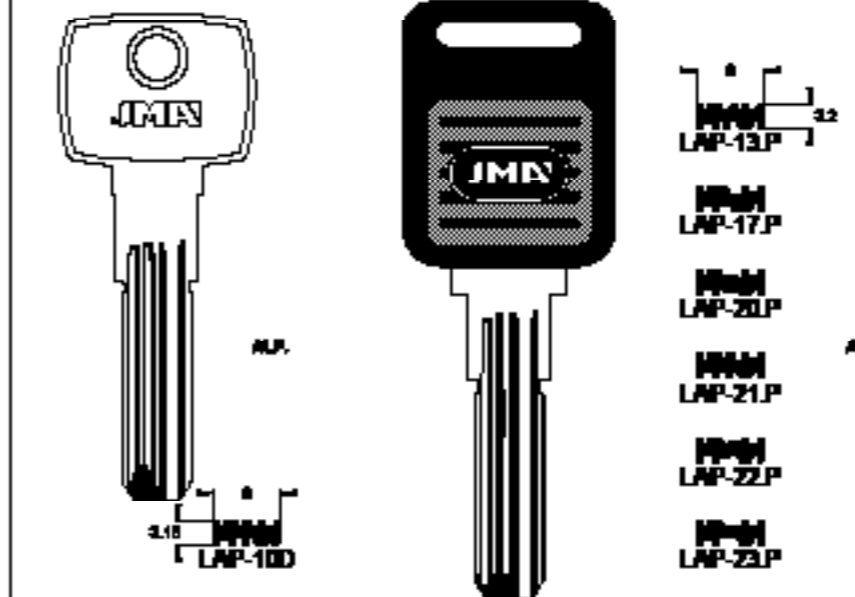

FOR: LINCE®

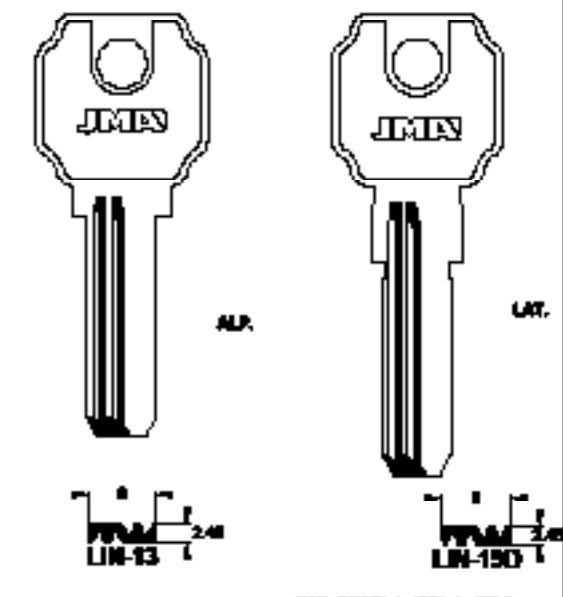

FOR: GRAN®-JMA®-SIB®

FOR: LINCE®

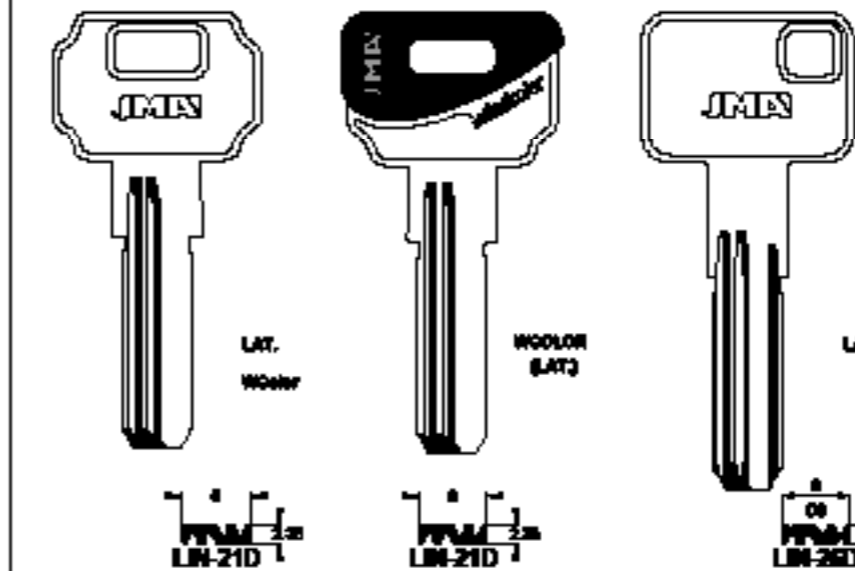

FOR: LT®

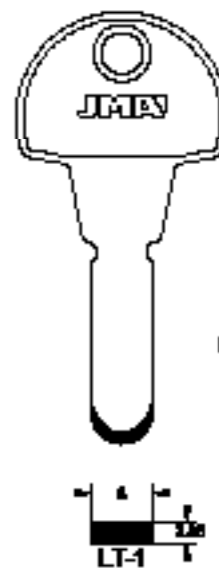

FOR: MAGNUM®

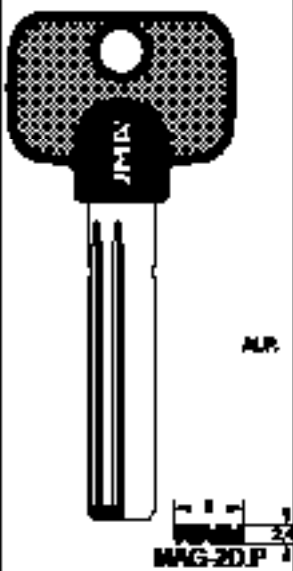

Concerning the marks and commercial denominations see legal warning.
 Concerniente a las marcas y denominaciones comerciales ver aviso legal.
 Marka eta izendapen komertzialiei dagokienez, ikus lege-oharra.
 Concernant les marques et dénominations commerciales voir la note dans l'index.



JMA Opening the future

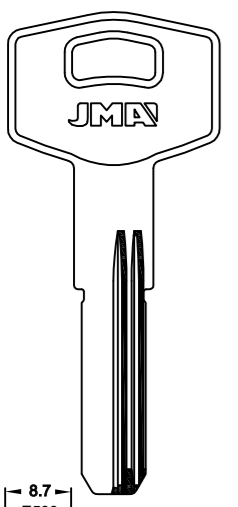
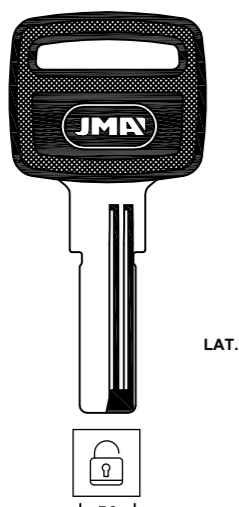
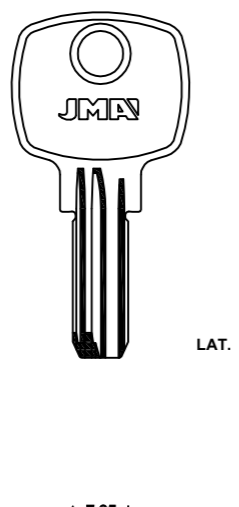
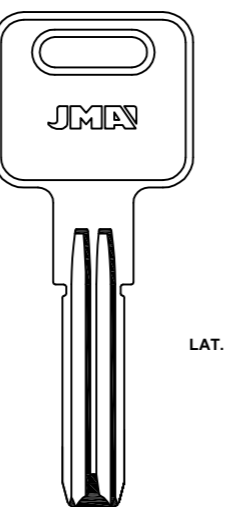

JMA Opening the future

Beziehen auf die Marke und Handelsname sehen Sie die Notiz im Impressum.
 Relativamente às marcas e denominações comerciais, ver aviso legal.
 Jeśli chodzi o znaki i nazwy handlowe, patrz Informacje prawne.

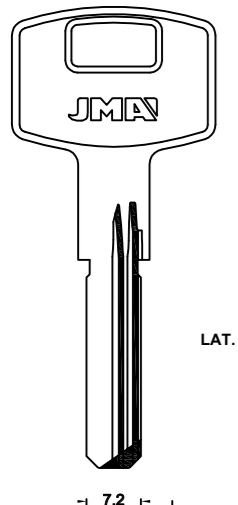
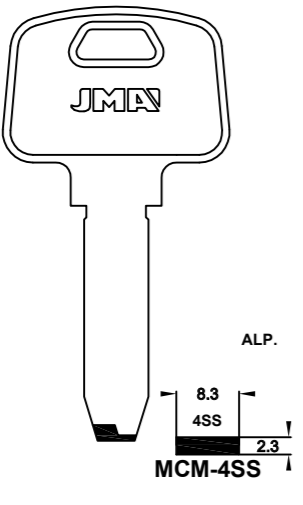
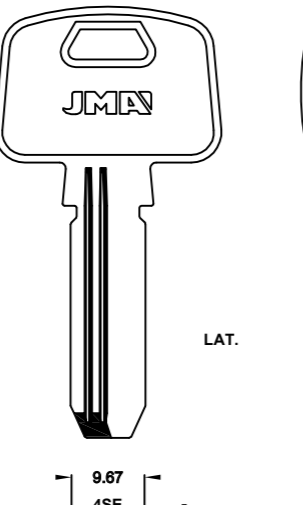

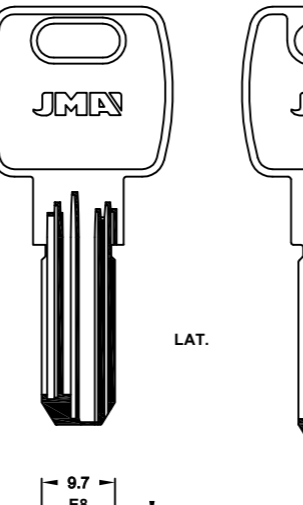
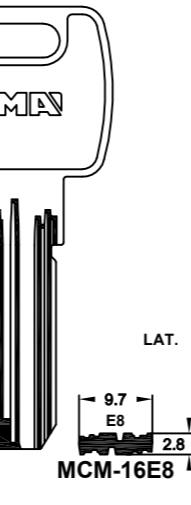

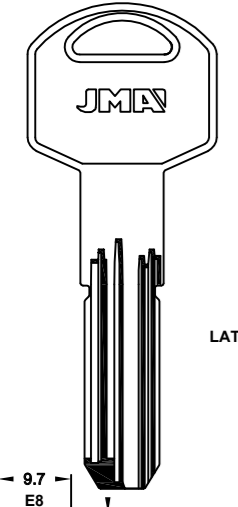
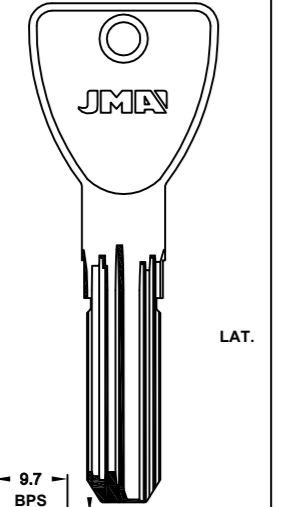
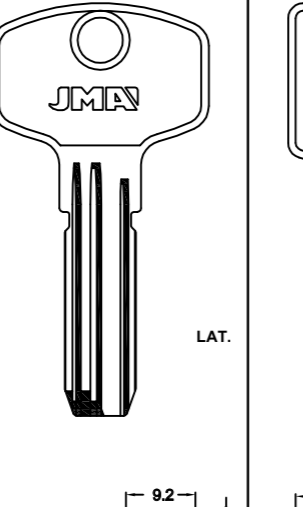

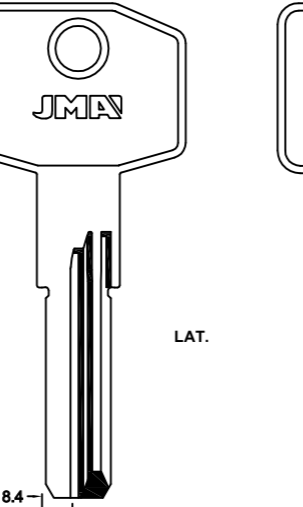

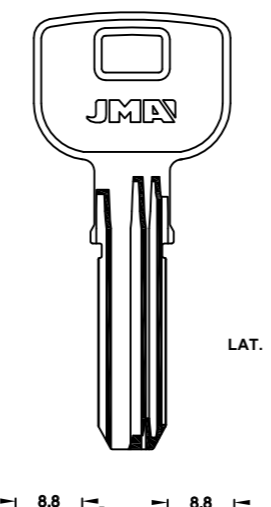
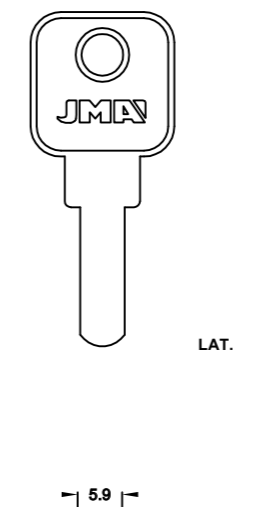
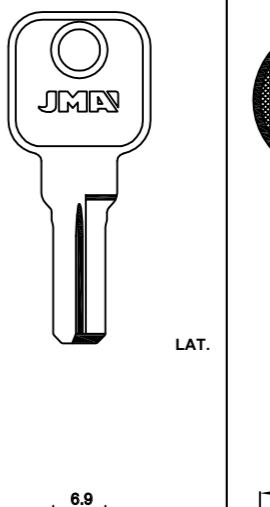
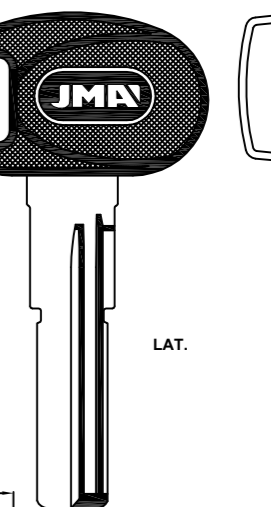

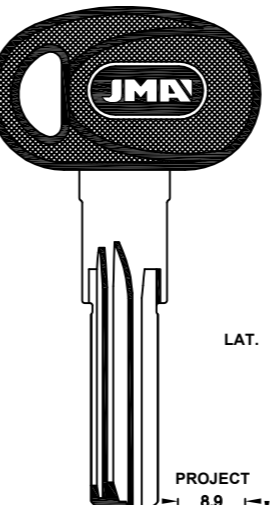
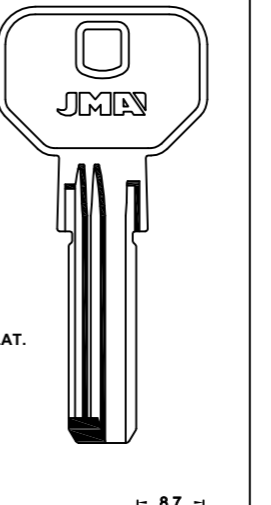
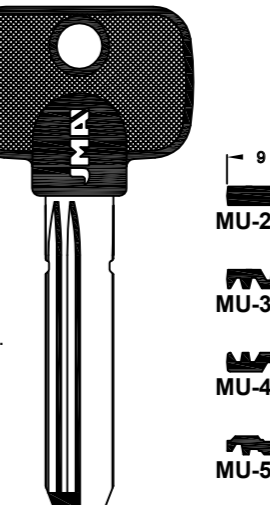
<p>FOR: MARQUES®</p>  <p>MQ-3</p> <p>790 E500 796</p> <p>FOR: AGC®-MARC®-RODES®</p>	<p>FOR: MASTER®</p>  <p>MAS-15.P</p>	<p>FOR: MASTER LOCK®</p>  <p>MASL-1</p>	<p>FOR: MAUER®</p>  <p>MAU-1</p>
---	---	--	--

<p>FOR: MAUER®</p>  <p>MAU-2</p>	<p>FOR: MCM®</p>  <p>MCM-4SS</p> <p>FOR: LOB®-YETI®</p>  <p>MCM-10</p> <p>FOR: ESAFE®-TROMER®</p>  <p>MCM-11S</p>  <p>MCM-15E8</p>  <p>MCM-21D</p> <p>FOR: DIERRE®-GERDA®</p>			
--	--	--	--	--

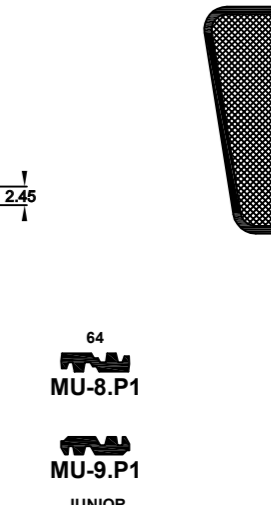
<p>FOR: MCM®</p>  <p>MCM-27</p> <p>FOR: GERDA®</p>	<p>FOR: MEGA®</p>  <p>MEG-1D</p> <p>FOR: HOK®</p>	<p>FOR: MGA (MONTI)®</p>  <p>MGA-2</p> <p>FOR: TROMER®</p>	<p>FOR: MCM®</p>  <p>MCM-45</p>	<p>FOR: MGA (MONTI)®</p>  <p>MGA-3</p>
---	---	--	---	---

<p>FOR: MHA®</p>  <p>MH-1</p> <p>FOR: TOP LOCK®</p>	<p>FOR: MLM®</p>  <p>MLM-4</p>	<p>FOR: MOTTURA®</p>  <p>MT-1.P</p>	<p>FOR: MOTTURA®</p>  <p>MT-2D</p> <p>600001-613040 900001-902780</p> <p>FOR: GEVY®-STV®</p>
--	---	--	---

<p>FOR: MOTTURA®</p>  <p>MU-2.P1</p>	<p>FOR: MSM®</p>  <p>MSM-1D</p>	<p>FOR: MUL.T.LOCK®</p>  <p>MU-3.P1</p>  <p>MU-4.P1</p>  <p>MU-5.P1</p>  <p>MU-7.P1</p>  <p>MU-8.P1</p>  <p>MU-9.P1</p>  <p>MU-10.P</p>  <p>MU-11.P1</p>  <p>MU-16.P</p> <p>FOR: GAMMA®</p>
---	--	---

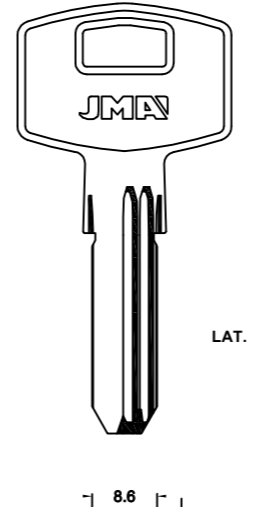
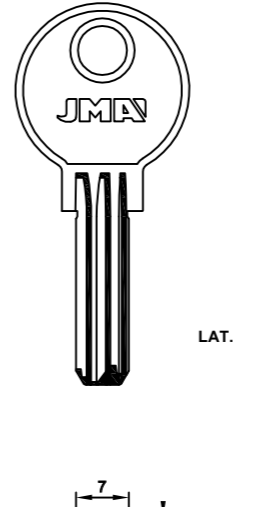
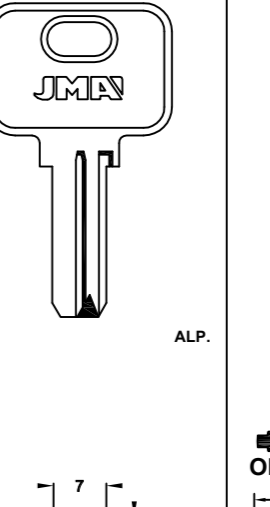
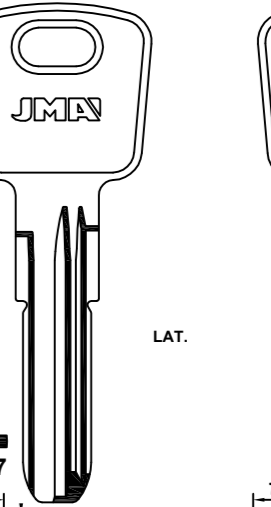
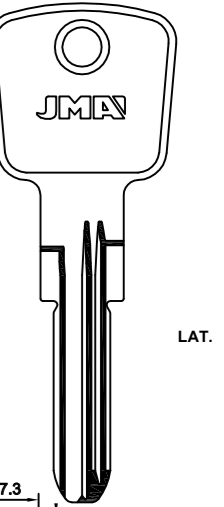
<p>FOR: NOORI®</p>  <p>NOR-1</p> <p>FOR: IBFM®</p>	<p>FOR: OJMAR®</p>  <p>OJ-20/4</p>	<p>FOR: OJMAR®</p>  <p>OJ-Q</p>	<p>FOR: OMEC®</p>  <p>OMC-3</p> <p>FOR: SANTOS®-CAIB®-IPAR®</p>	<p>FOR: OMEC®</p>  <p>OMC-4</p> <p>FOR: IMPAR®</p>
--	--	---	---	--

Concerning the marks and commercial denominations see legal warning.
 Concerniente a las marcas y denominaciones comerciales ver aviso legal.
 Marka eta izendapen komertzialiei dagokienez, ikus lege-oharra.
 Concernant les marques et dénominations commerciales voir la note dans l'index.

JMA® Opening the future

JMA® Opening the future

Beziehen auf die Marke und Handelsname sehen sie die Notiz im Impressum.
 Relativamente às marcas e denominações comerciais, ver aviso legal.
 Jeśli chodzi o znaki i nazwy handlowe, patrz Informacje prawne.



FOR: PICARD®	FOR: POTENT®				FOR: PREFER®
LAT.	LAT.	LAT.	LAT.	LAT.	LAT.
PCB: MEO®	PTN-1D	PTN-2D	PTN-3D	PTN-4D	PR-21

FOR: STS®				
ALP.	ALP.	ALP.	ALP.	LAT.
STS-B1	STS-T14	STS-T15	STS-TV3	STS-TV5
FOR: DRY®		FOR: POWDER®-TOM®-2E®		FOR: TOM®

FOR: ROSSETTI®	FOR: SEA®		FOR: SECUREMME®	
LAT.	ALP.	ALP.	LAT.	LAT.
ROSE-1	SEA-1	SEA-2	SEC-1	SEC-2
	FOR: EXCEL®-HALL®-MEMA®		FOR: YOL®	SEC-3

FOR: STS®	FOR: TARONI®	FOR: TECON®		FOR: TECSESA®
LAT.	LAT.	LAT.	LAT.	ALP.
STS-2E	TRD-1	TC-1	TC-3	TEC-2
FOR: TOM®				

FOR: SECURITAL®	FOR: SERRALLER®	FOR: SPIDER®		FOR: STANDERS®	FOR: STS®
ALP.	LAT.	LAT.	LAT.	LAT.	LAT.
SCR-1	SER-3D	SPI-1	SPI-1D	STN-1D	STS-35
FOR: NYR®		FOR: OSWEN®-OCENY®-LEON®		FOR: PTH®	FOR: STS STS-38

FOR: TESA®				
ALP.	ALP.	LAT.	WOLOR (LAT)	LAT.
TE-T10	TE-T11	TE-T12	TE-T12 PLUS	TE-T12
FOR: DOR®-SAL®-SER®-PAP®-FRI®		FOR: THOMAS LACLO®		FOR: THOMAS LACLO®

Concerning the marks and commercial denominations see legal warning.
 Concerniente a las marcas y denominaciones comerciales ver aviso legal.
 Marka eta izendapen komertzialiei dagokienez, ikus lege-oharra.
 Concernant les marques et dénominations commerciales voir la note dans l'index.



Beziehen auf die marke und handelsname sehen sie die notiz im Impressum.
 Relativamente às marcas e denominações comerciais, ver aviso legal.
 Jeśli chodzi o znaki i nazwy handlowe, patrz Informacje prawne.

FOR: TESA®

ALP. ALP.

TE-T80
TE-T80EH
TE-T80SC
TE-T82

FOR: ESAFE® - STS® - TOPLOCK® - YEMAR®

FOR: TITAN®

LAT. LAT. LAT. LAT.

TIT-6
TIT-21
TIT-22
TIT-23
TIT-27

FOR: CR® - DECAEUX® - IMPAR® FOR: UCER® FOR: HERACLES®

FOR: UCER®

ALP. ALP. LAT. LAT. ALP.

UCER-8D.P
UCER-13D
UCER-17D
UCER-20D
UCER-21

FOR: PH® FOR: REMOCON®

FOR: TITAN®

LAT.

TIT-26

FOR: BASI® - METALUX®

FOR: T-KEY®

LAT.

TKY-2
TKY-3

FOR: BAILING LOCK® - LOB®

FOR: TOVER®

ALP. ALP. * LAT. ALP.

TOV-2
TOV-4
TOV-5
TOV-8D

FOR: TROMER®

FOR: UCER®

LAT.

UCER-22D

UNIVERSAL

LAT. LAT. LAT. LAT.

TX-1
TX-2
TX-17
TX-22

FOR: ISEO® - GERDA®

FOR: URBIS®

LAT.

URB-3D
URB-4D

FOR: BANE SEKULIC®

FOR: TOVER®

LAT. LAT.

TOV-6
TOV-7

FOR: UCER®

ALP. LAT. WColor (LAT.)

UCER-51
UCER-5D
UCER-8D
UCER-8D'

FOR: PENT® FOR: DEBEAURAIN® - ESAFE® - ISEO® - ND® - YEMAR®

FOR: VACHETTE®

ALP. ALP. ALP. LAT. ALP.

VA-25
VA-26
VA-27
VA-28
VA-56
VA-58
VA-70
VA-91

FOR: RADIAL® FOR: RADIAL® FOR: RADIAL® NEW VER. 1998

Concerning the marks and commercial denominations see legal warning.
 Concerniente a las marcas y denominaciones comerciales ver aviso legal.
 Marka eta izendapen komertzialiei dagokienez, ikus lege-oharra.
 Concernant les marques et dénominations commerciales voir la note dans l'index.

JMA® Opening the future

JMA® Opening the future

Beziehen auf die Marke und Handelsname sehen Sie die Notiz im Impressum.
 Relativamente às marcas e denominações comerciais, ver aviso legal.
 Jeśli chodzi o znaki i nazwy handlowe, patrz Informacje prawne.

K02 / 141

140 / K02

<p>FOR: VIRO®</p> <p>LAT.</p> <p>8.75 2.9 VI-14</p> <p>FOR: EURO-PRO®</p>	<p>FOR: WANJIN®</p> <p>LAT.</p> <p>8.8 2.2 WAN-1D</p> <p>FOR: HOOPLY®</p>	<p>FOR: WILKA®</p> <p>LAT.</p> <p>2.55 9 WIL-22</p> <p>SERIE 3600</p>	<p>FOR: YALE®</p> <p>LAT.</p> <p>7.35 2.35 YA-65</p> <p>FOR: MASTER®</p>
---	---	---	--

FOR: YALE®

<p>LAT.</p> <p>9.37 2.85 YA-81</p>	<p>LAT.</p> <p>8.6 3 YA-280D</p>	<p>LAT.</p> <p>H 9 2.4 YA-281D</p>	<p>LAT.</p> <p>1000 8.8 2.8 YA-282</p>
--	--	--	--

FOR: YALE®

<p>LAT.</p> <p>9 2.8 YA-283D</p>	<p>LAT.</p> <p>2100 9 2.5 YA-286D</p>	<p>LAT.</p> <p>D PB 8.9 2.5 YA-301D</p>	<p>LAT.</p> <p>WG 8.3 2.8 YA-306</p>
--	---	---	--

<p>FOR: YARDENI®</p> <p>ALP.</p> <p>8.85 2.45 YAR-1</p>	<p>LAT.</p> <p>8.9 2.45 YAR-2</p>	<p>LAT.</p> <p>8.9 2.45 YAR-3</p> <p>YAR-4D</p>	<p>FOR: YETI®</p> <p>LAT.</p> <p>8.8 2.5 YET-19D</p> <p>FOR: LOB®</p>
---	---	---	---

Concerning the marks and commercial denominations see legal warning.
 Concerniente a las marcas y denominaciones comerciales ver aviso legal.
 Marka eta izendapen komertzialiei dagokienez, ikus lege-oharra.
 Concernant les marques et dénominations commerciales voir la note dans l'index.



Beziehen auf die marke und handelsname sehen sie die notiz im Impressum.
 Relativamente às marcas e denominações comerciais, ver aviso legal.
 Jeśli chodzi o znaki i nazwy handlowe, patrz Informacje prawne.



TUBULAR KEYS

Llaves tubulares
Hodi formako giltzak

Clés tubulaires
Stiftzylinderschlüssel

Chaves tubulares
Klucze rurkowe

FOR: ABSA®

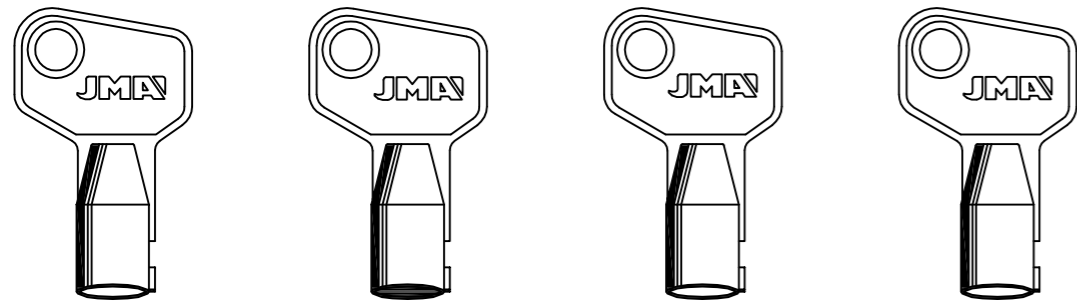

ZAM.

ZAM.

ZAM.

ZAM.

LAT.



AB-1T

FOR: KEYA®

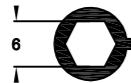

AB-2T

FOR: KEYA®-TOY®

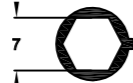

AB-3T

FOR: KEYA®

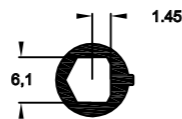

AB-4T

FOR: KEYA®



AGA-1T

FOR: AGA®

FOR: P&C I.®

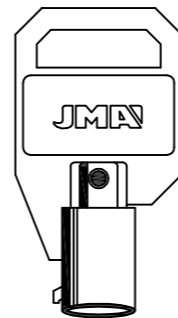

PCI-1T

FOR: P.C.®

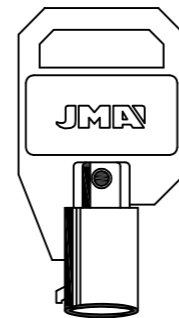

PC-1T

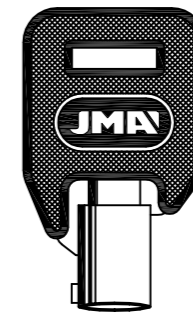

PC-3T.P

FOR: TSAG®

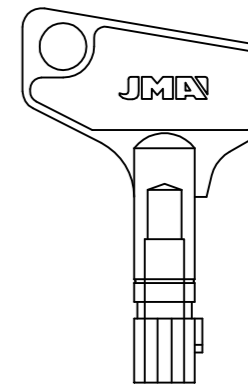

SAG-1T

FOR: AGA®

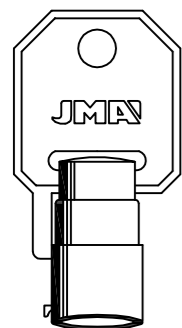

LAT.



AGA-2T

FOR: BARRIER®

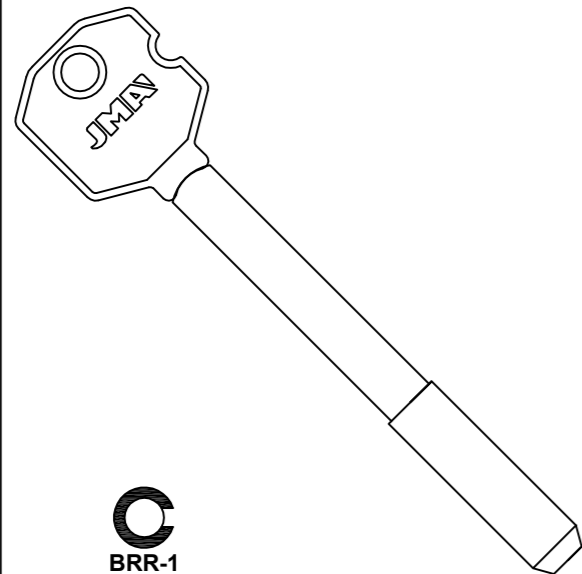

BRR-1

FOR: BILMA®

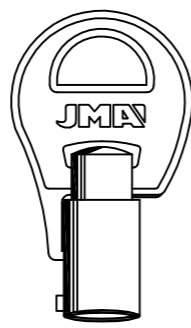

LAT.



BIL-1T

FOR: CHICAGO®

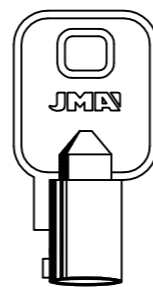

LAT.



CHI-1T

FOR: ACE®-ADEMCO®-AGA®-ALPHA®
FOR: EURO LOCKS®-FORT®-GELM®-L&F®

FOR: INCECA®

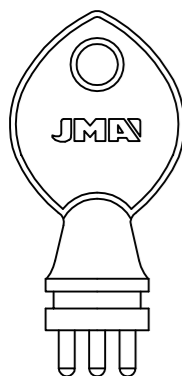

LAT.



INCE-1E

FOR: LYF®

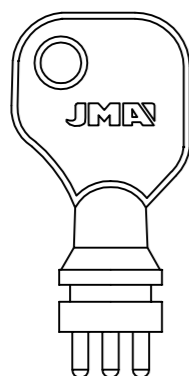

LAT.



INCE-2E

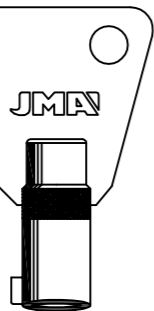

LAT.



LYF-2T

FOR: MERONI®

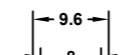
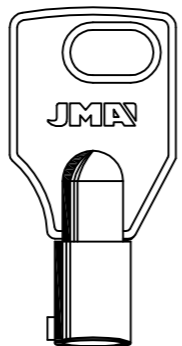

MER-1T

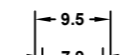
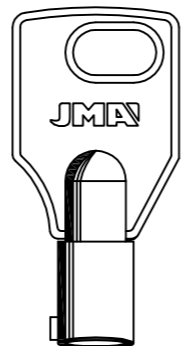

MER-3T

Concerning the marks and commercial denominations see legal warning.
Concerniente a las marcas y denominaciones comerciales ver aviso legal.
Marka eta izendapen komertzialiei dagokienez, ikus lege-oharra.
Concernant les marques et dénominations commerciales voir la note dans l'index.

JMA® Opening the future

JMA® Opening the future

Beziehen auf die Marke und Handelsname sehen Sie die Notiz im Impressum.
Relativamente às marcas e denominações comerciais, ver aviso legal.
Jeśli chodzi o znaki i nazwy handlowe, patrz Informacje prawne.





VEHICLE KEYS

Llaves de vehículos
Ibilgailuen giltzak

Clés de voitures
Fahrzeugschlüssel

Chaves de automóveis
Klucze do pojazdów

FOR: VARIOUS

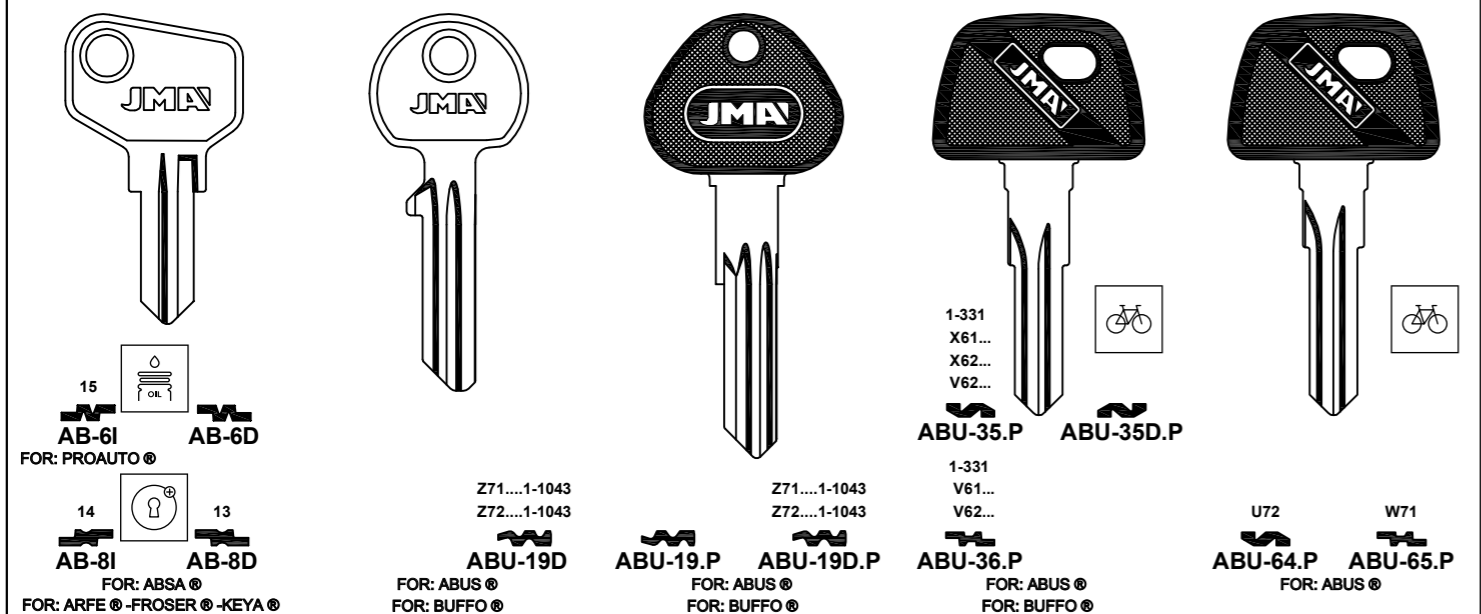

FOR: VARIOUS

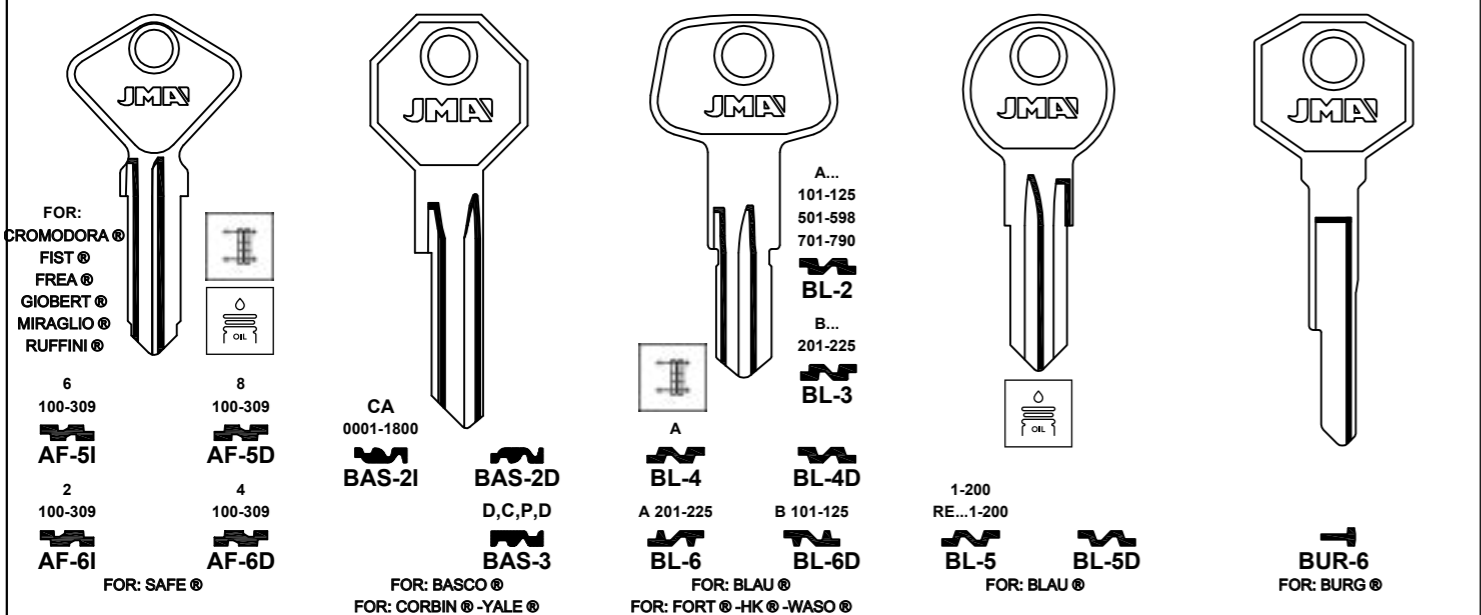

FOR: VARIOUS

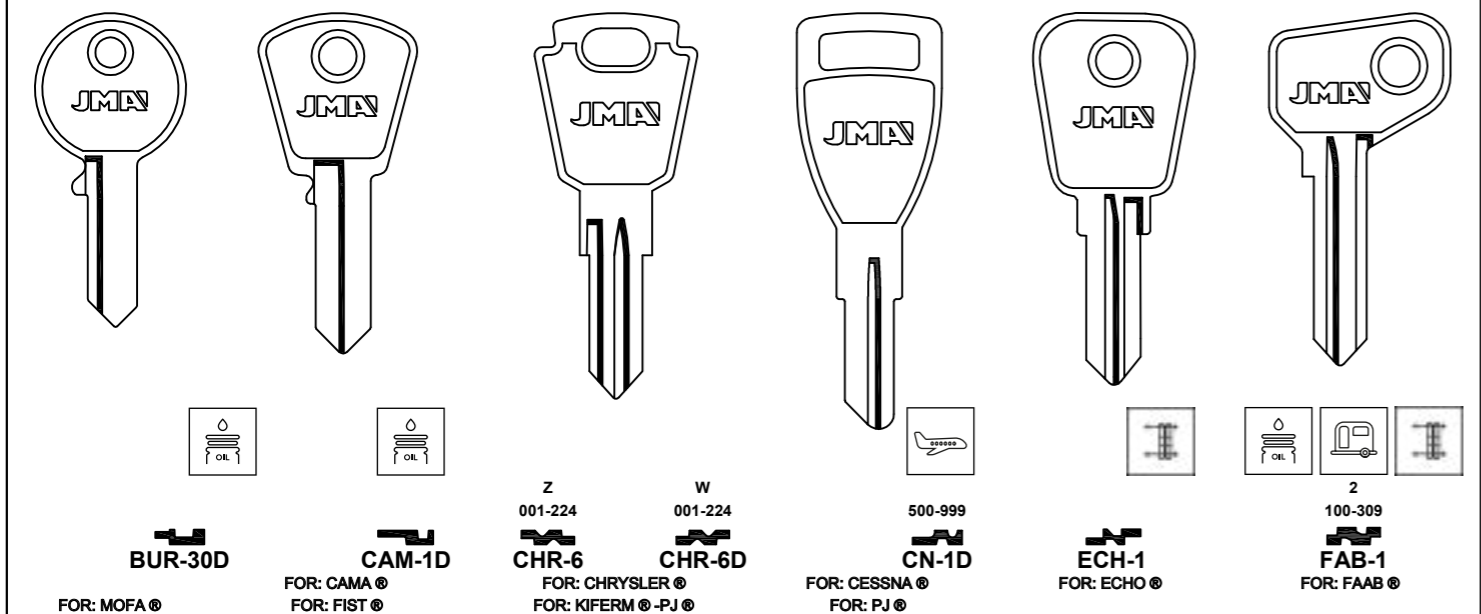

FOR: VARIOUS

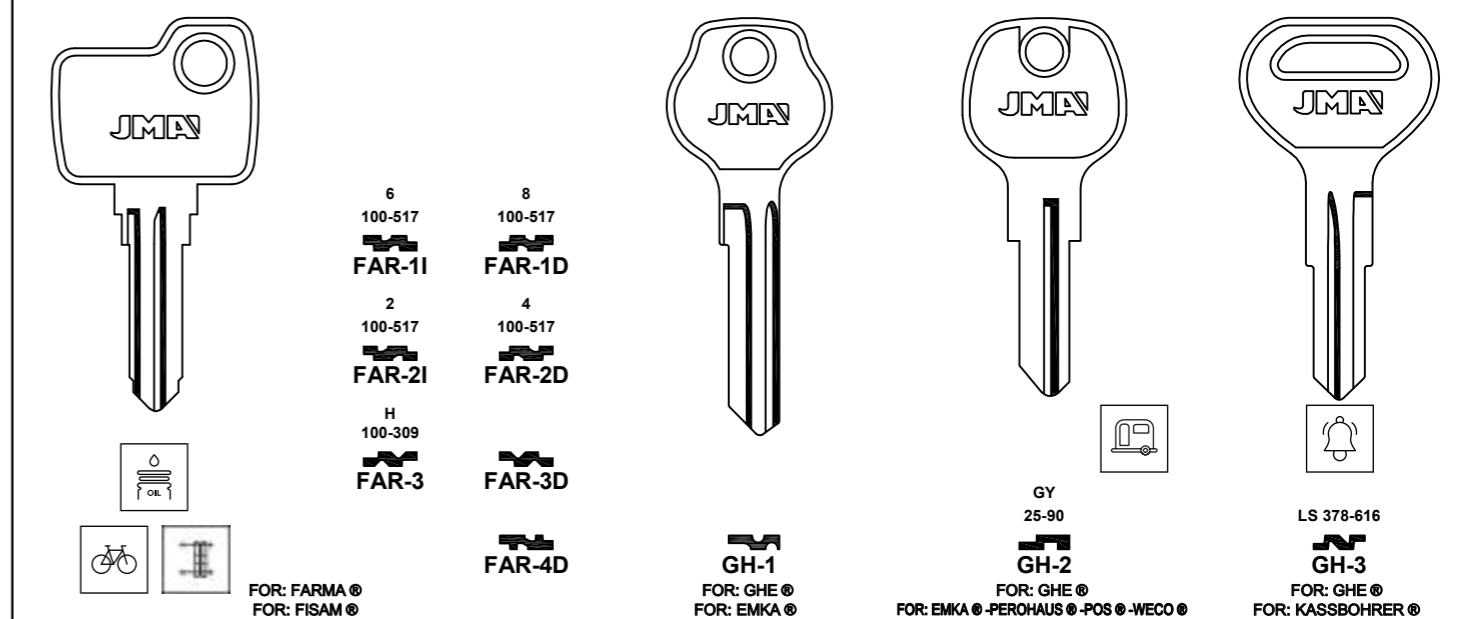

FOR: VARIOUS

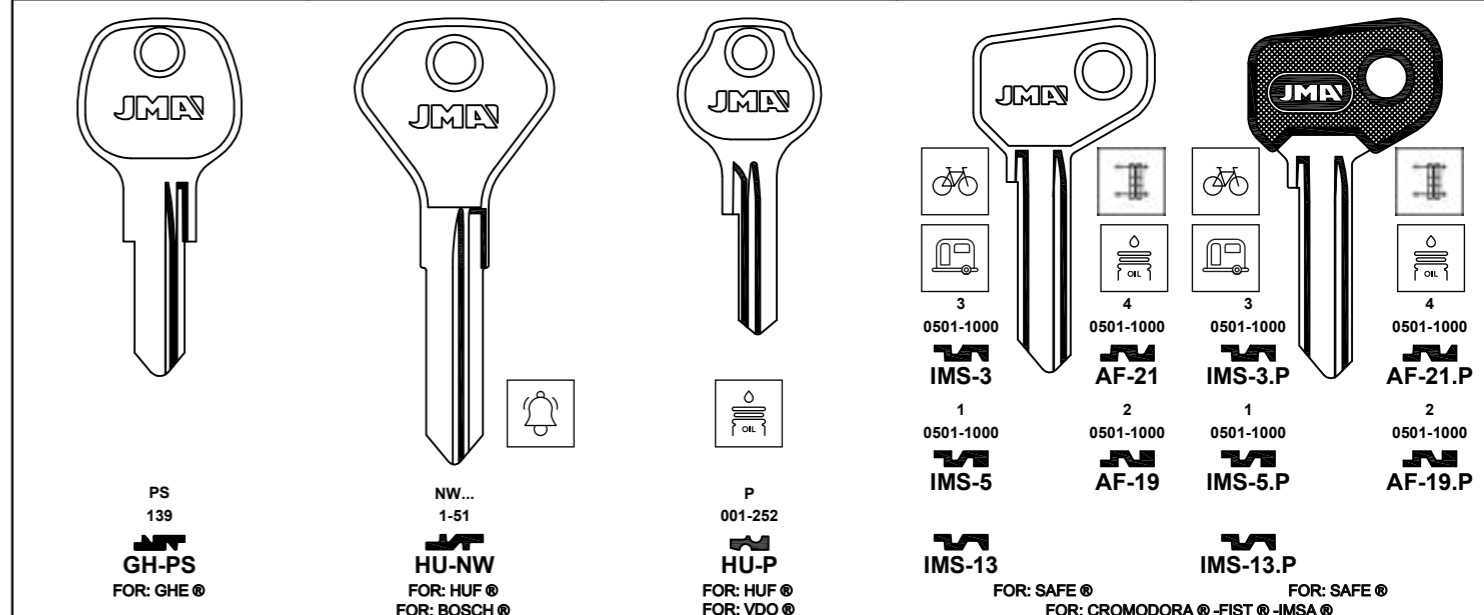

FOR: VARIOUS

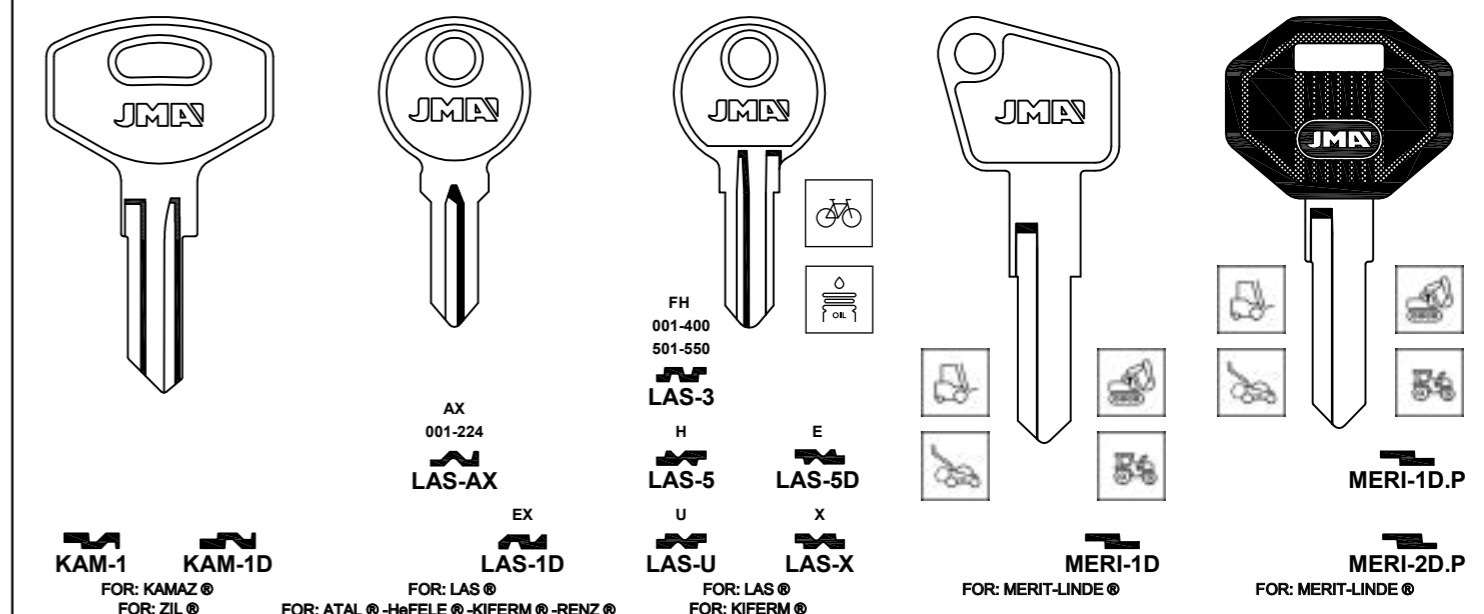

Concerning the marks and commercial denominations see legal warning.
 Concerniente a las marcas y denominaciones comerciales ver aviso legal.
 Marka eta izendapen komertzialiei dagokienez, ikus lege-oharra.
 Concernant les marques et denominations commerciales voir la note dans l'index.

FOR: VARIOUS

MERI-1.P1 FOR: MERIT-LINDE®

MOD-1D.P FOR: MONDIAL®

NE-1 FOR: NEIMAN®
FOR: CLAUSSOR®

NE-1D.P FOR: NEIMAN®
FOR: CLAUSSOR®

NE-2 FOR: NEIMAN®
FOR: CLAUSSOR®

FOR: AUDI®
HONDA®
MG®
ROVER®
BEDFORD®
FIAT IVECO®
VOLVO®

...2001-4949
GM®
...2001-3000

...2001-4949
GM®
...2001-3000

S,T,X,Y
Z,R
1-2-3-5-7

FOR: VARIOUS

NE-27 FOR: NEIMAN®

NE-30 FOR: NEIMAN®
FOR: BASTA®

NE-30.P FOR: NEIMAN®
FOR: BASTA®

NE-31 FOR: NEIMAN®
FOR: BASTA®

NE-31.P FOR: NEIMAN®
FOR: BASTA®

...
5001-6278

...
5001-6278

...1/9...A/Z
M-N-P-R-S

...1/9...A/Z
M-N-P-R-S

FOR: VARIOUS

NE-32 FOR: NEIMAN®
FOR: BASTA®

NE-32.P FOR: NEIMAN®
FOR: BASTA®

NE-44.P FOR: NEIMAN®
FOR: CLAUSSOR®

NE-48 FOR: NEIMAN®
FOR: CLAUSSOR®

NE-49 FOR: NEIMAN (RA)®

...A/Z
B-C-D-E
1/9...A/Z
1/9...A/Z
...A/Z
B-D-E-G-H-J
.1/9...A/Z
.1/9...A/Z
E-M-N-P-R

...A/Z
A/Z...A/Z
1 AL 7
...A/Z
0 AL 9

FOR: VARIOUS

NE-54.P FOR: NEIMAN (RA)®

NE-57 FOR: NEIMAN®

NE-63D FOR: NEIMAN®

OP-1 FOR: HUF®

M...
1-2-3-4-5

FOR: VARIOUS

OP-BB FOR: HUF®

OP-CC

OP-DD

PRE-21 FOR: PRESTA®
FOR: LAPORTE®

SI-1D FOR: SISPA®
FOR: AUTOBLOCK®

CC...501-1000
CC...1751-2000
CC...2501-3000

DD...501-1000
DD...1751-2000
DD...2501-3000

B...1-380
BB...501-1000
BB...1751-2000
BB...2501-3000

EE...501-1000
EE...1751-2000
EE...2501-3000

FF...501-1000
FF...1751-2000
FF...2501-3000

...7700-7749

C3..AA-ZY
D3..AA-HR
J...1-544

C4..AA-ZY
D4..AA-HR
RO-5I
RO-5D

...1100-1307

FOR: VARIOUS

SI-3 FOR: SISPA®
FOR: AUTOBLOCK®

SI-3D

SI-4 FOR: SISPA®
FOR: AUTOBLOCK®

SI-4D

SIM-1200 FOR: ABSA®

SIX-5.P FOR: SIMPLEX®
FOR: CITROEN®

STR-3 FOR: STREBOR®
FOR: UNION®

1...
SI-2D

...1100-1307

8

0111111
AL
628888

SF...101-199
SR...301-399
SS...201-299
SO...01-99

Concerning the marks and commercial denominations see legal warning.
Concerniente a las marcas y denominaciones comerciales ver aviso legal.
Marka eta izendapen komertzialiei dagokienez, ikus lege-oharra.
Concernant les marques et denominations commerciales voir la note dans l'index.

FOR: VARIOUS

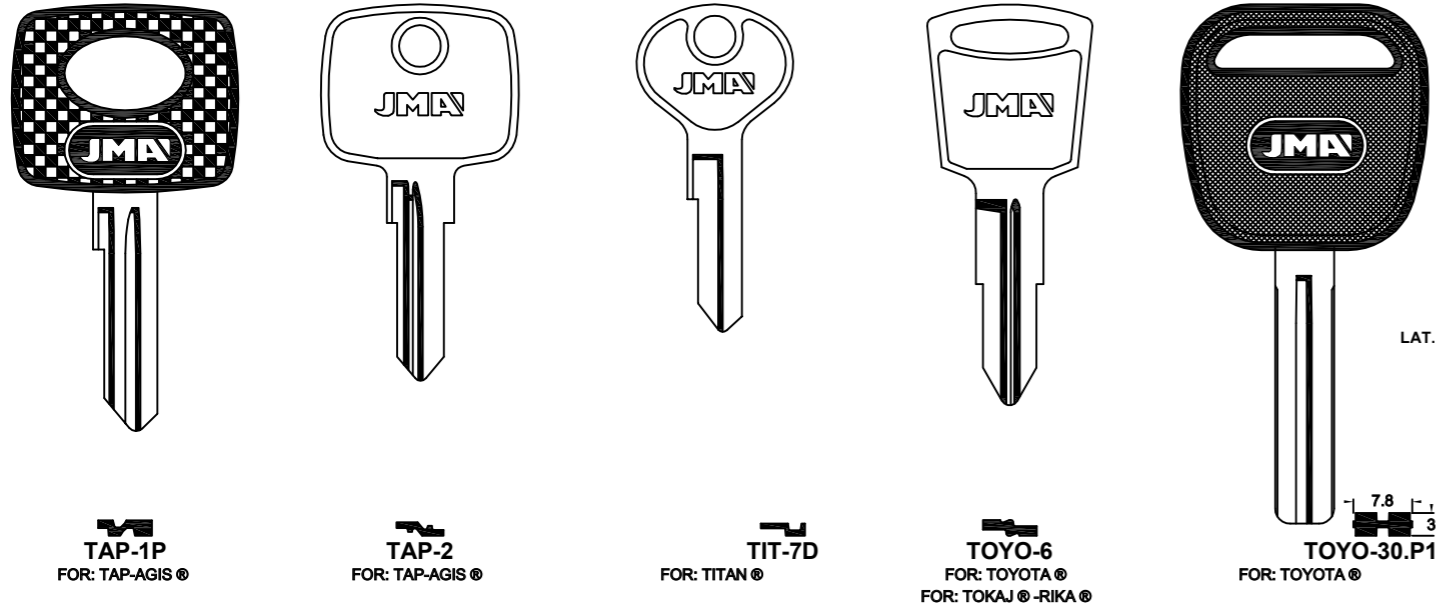

FOR: VARIOUS

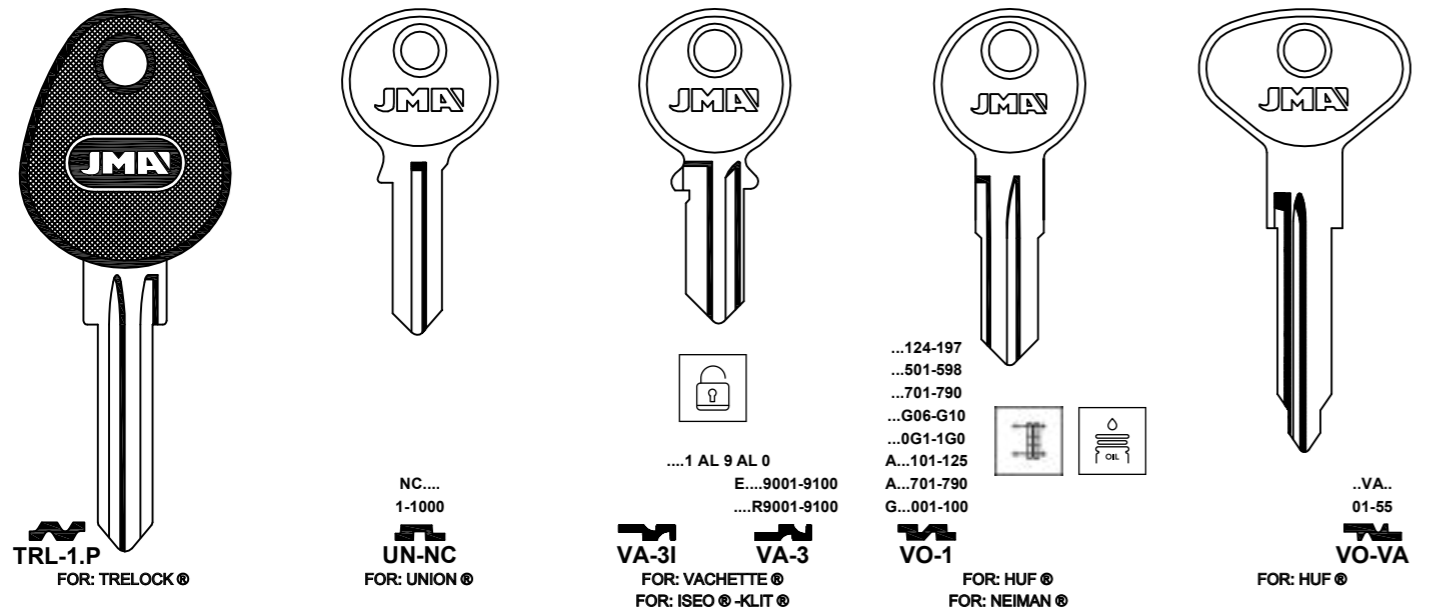

FOR: VARIOUS

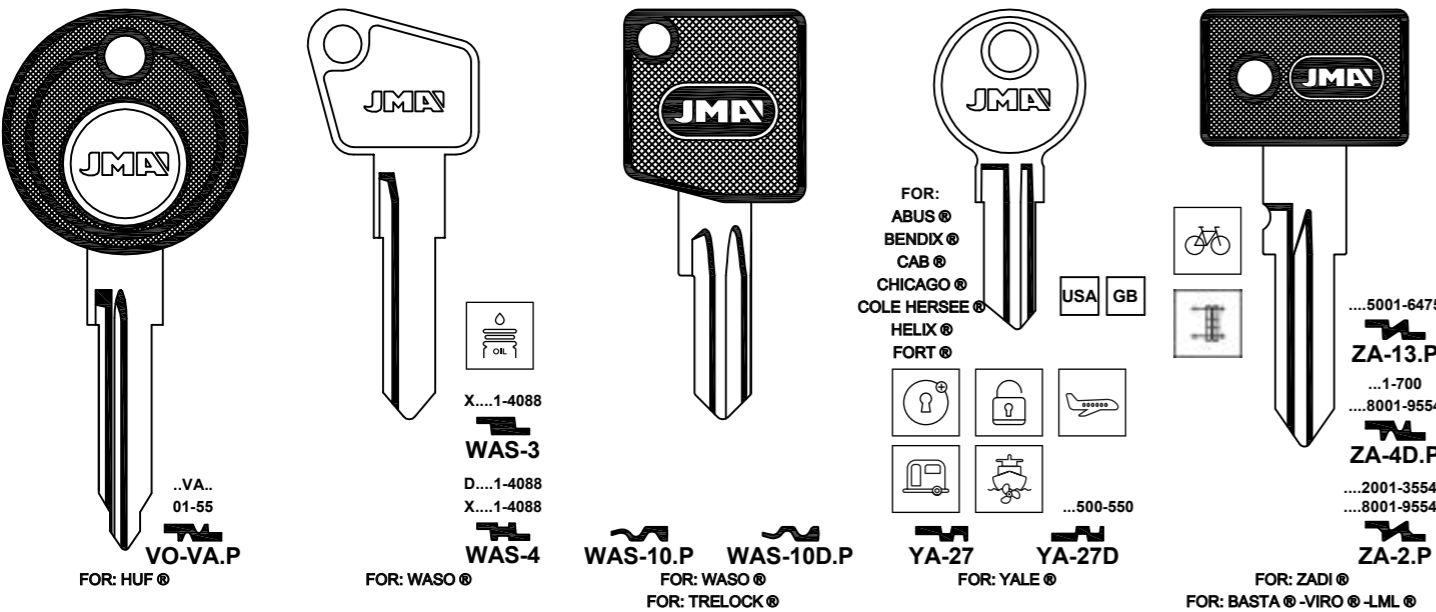

FOR: VARIOUS

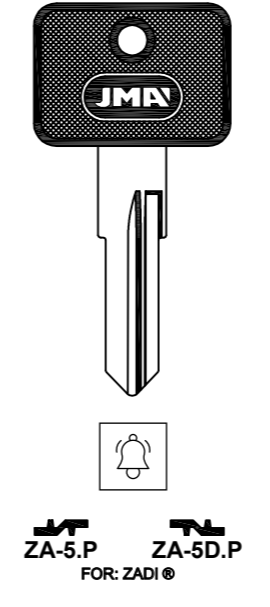

FOR: ABARTH®

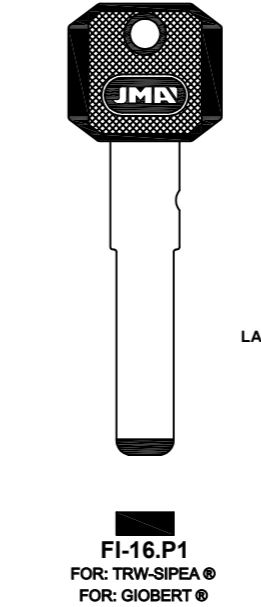

FOR: ABT®

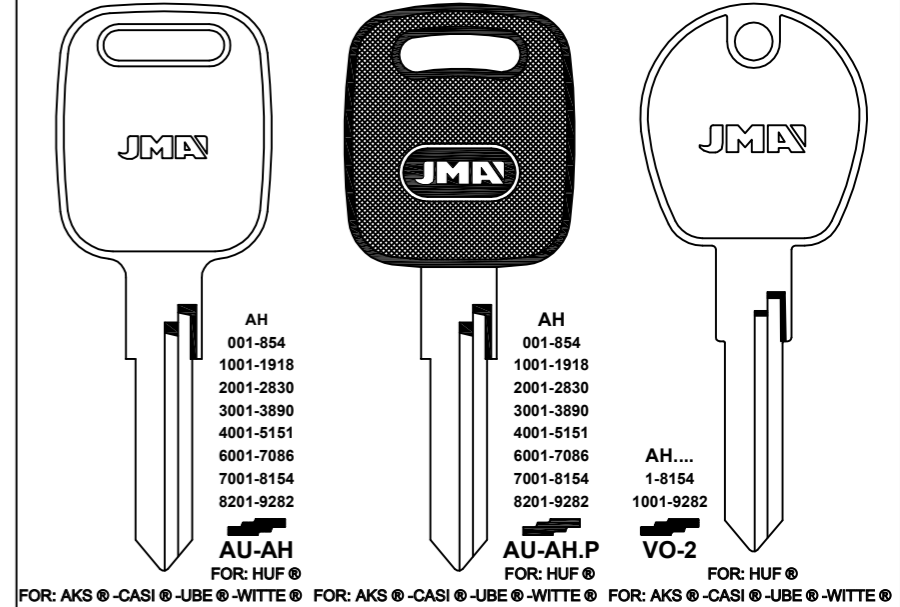

FOR: HUF®

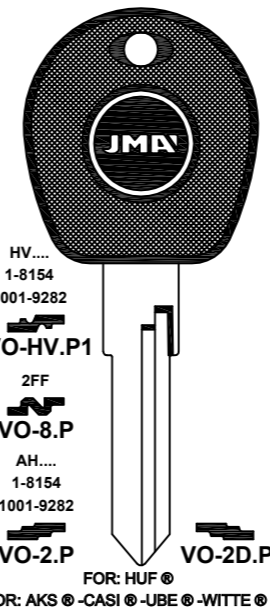

FOR: ACM®

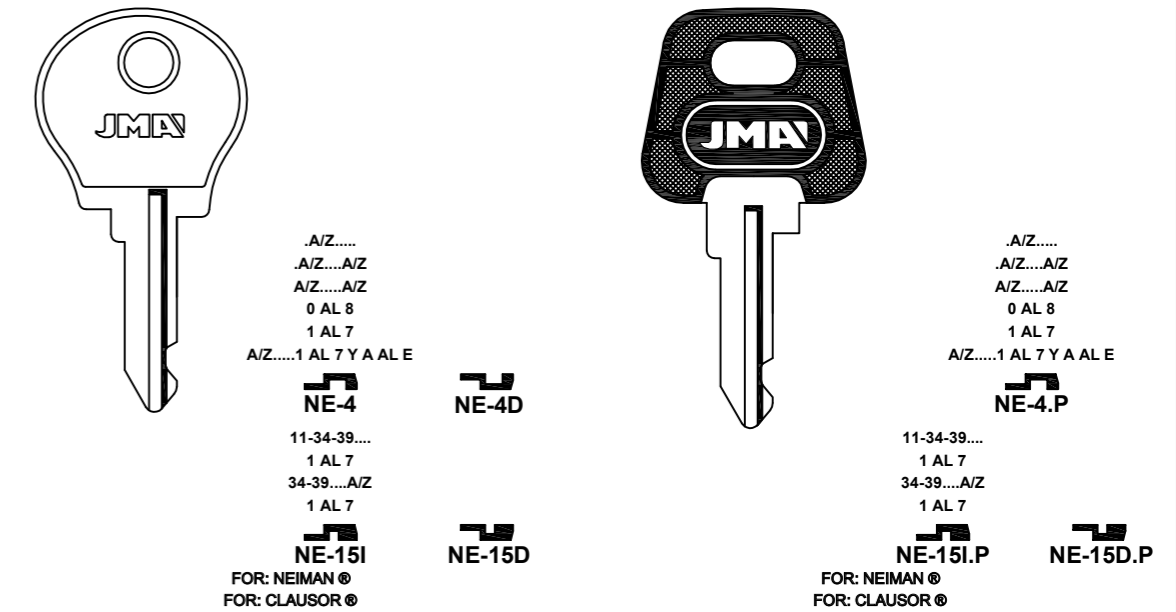

FOR: ACM®

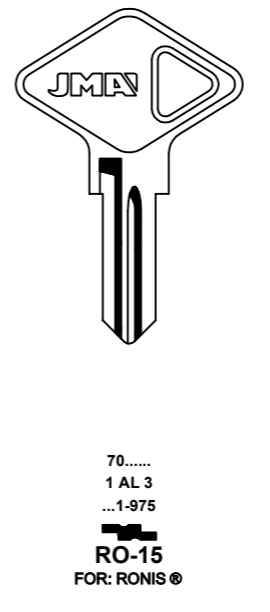

FOR: ACURA (HONDA)®

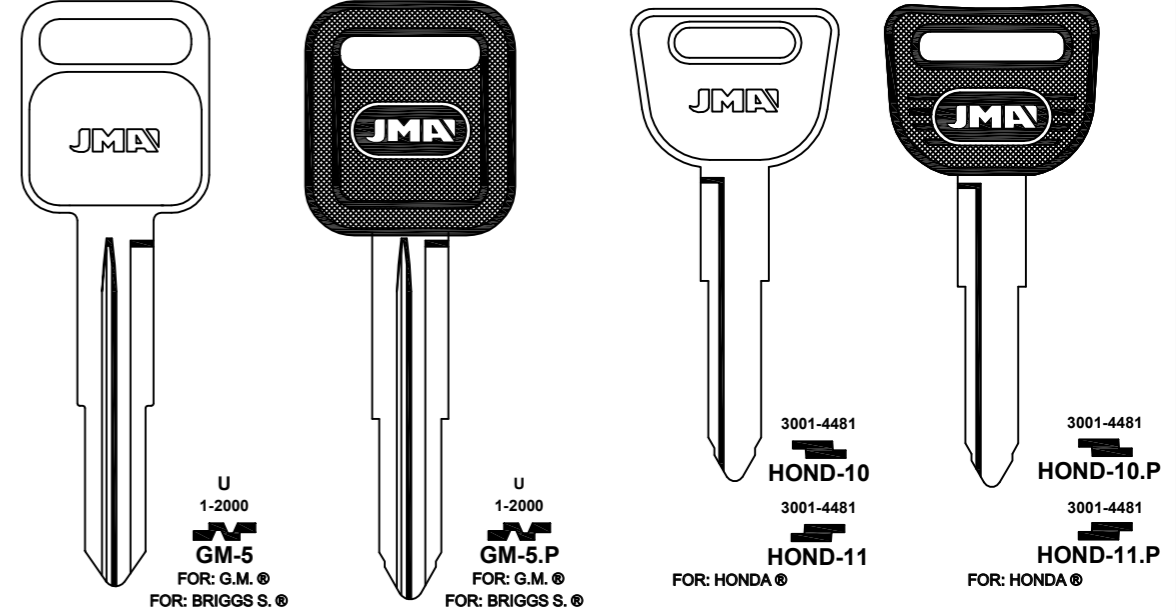

Concerning the marks and commercial denominations see legal warning.
 Concerniente a las marcas y denominaciones comerciales ver aviso legal.
 Marka eta izendapen komertzialiei dagokienez, ikus lege-oharra.
 Concernant les marques et denominations commerciales voir la note dans l'index.

JMA Opening the future

JMA Opening the future

Beziehen auf die marke und handelsname sehen sie die notiz im Impressum.
 Relativamente às marcas e denominações comerciais, ver aviso legal.
 Jeśli chodzi o znaki i nazwy handlowe, patrz Informacje prawne.

FOR: ACURA (HONDA) ®

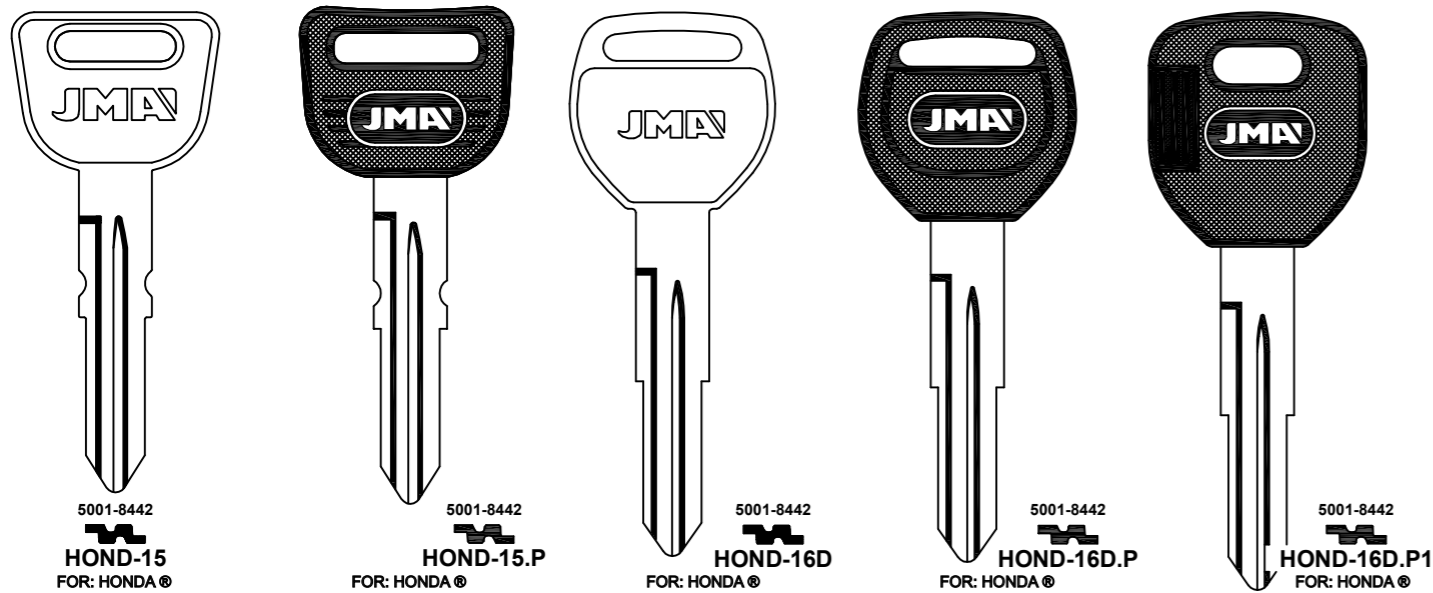

FOR: ACURA (HONDA) ®

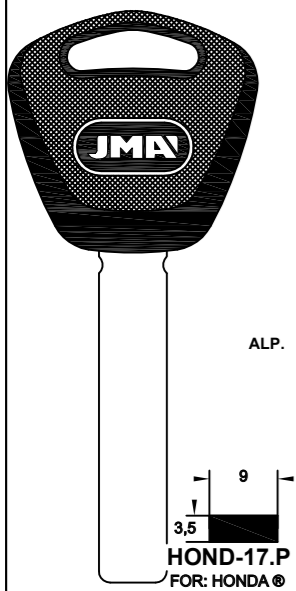

FOR: AIXAM ®

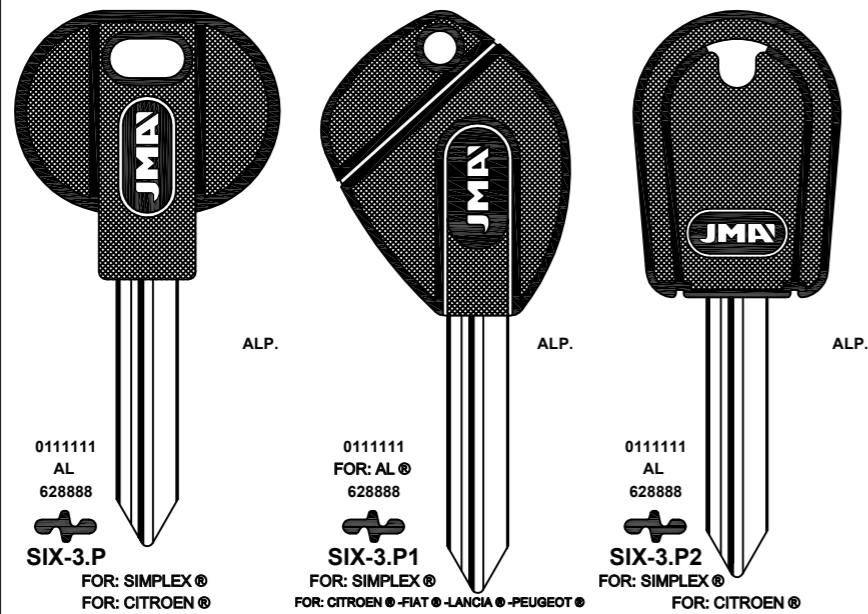

FOR: ALFA ROMEO ®

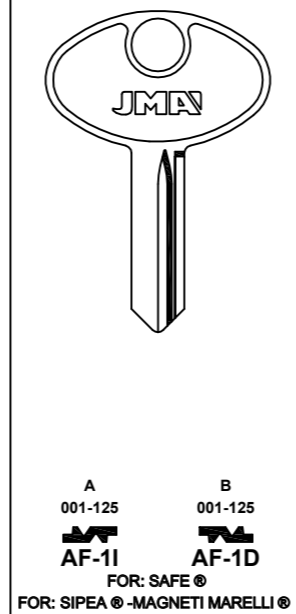

FOR: ALFA ROMEO ®

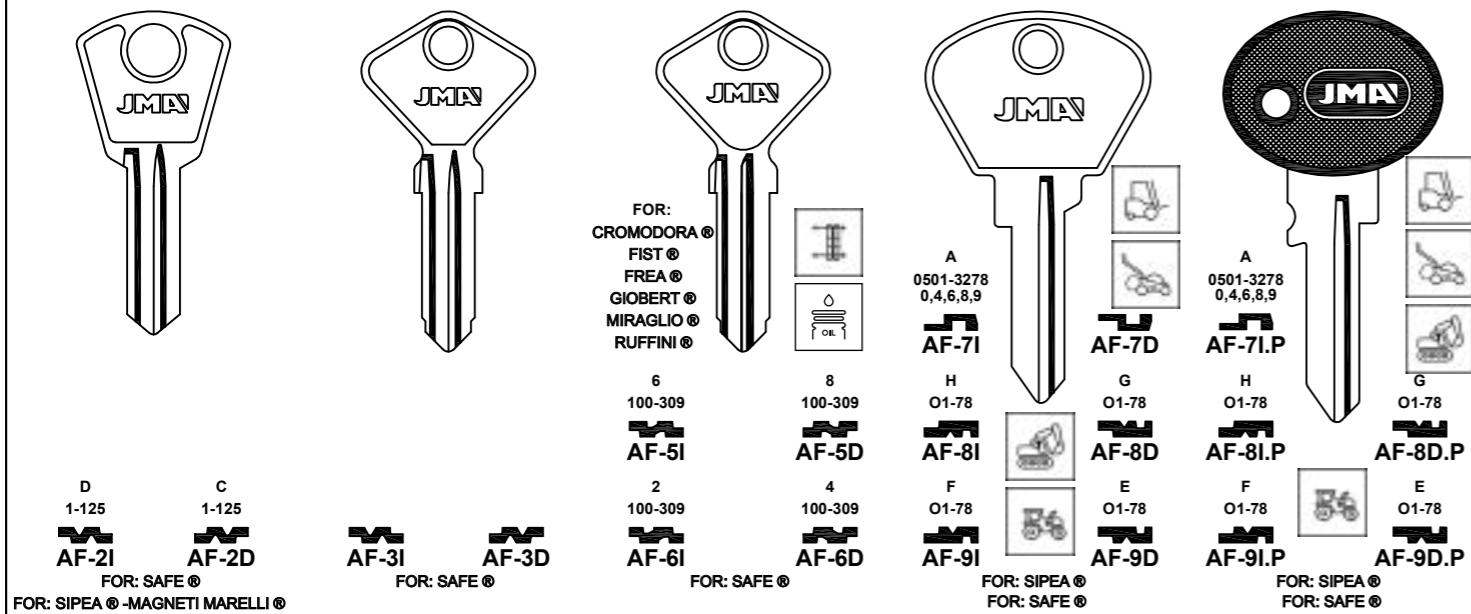

FOR: ALFA ROMEO ®

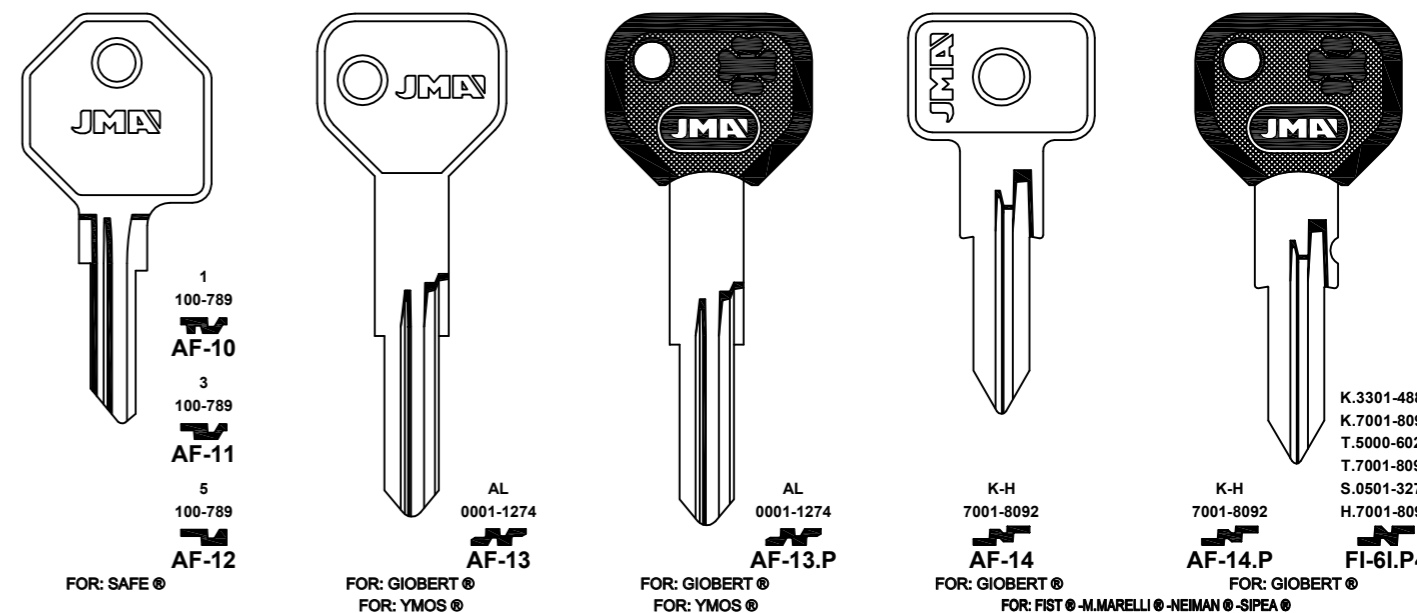

FOR: ALFA ROMEO ®

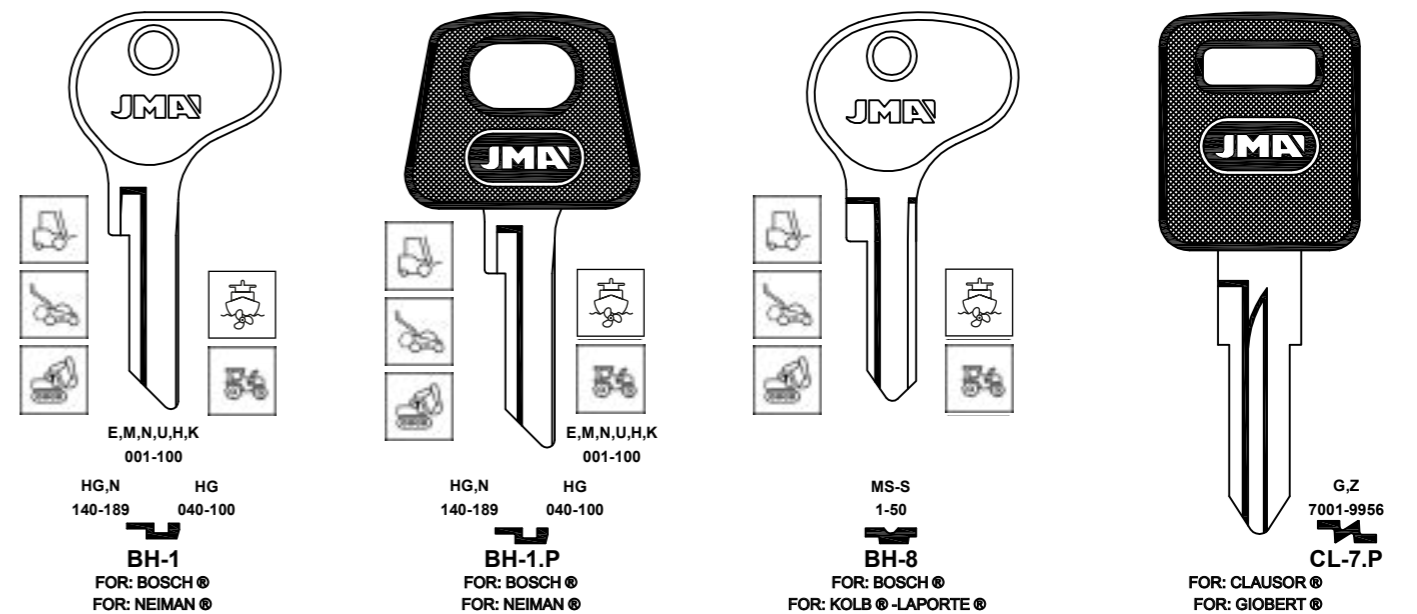

FOR: ALFA ROMEO ®

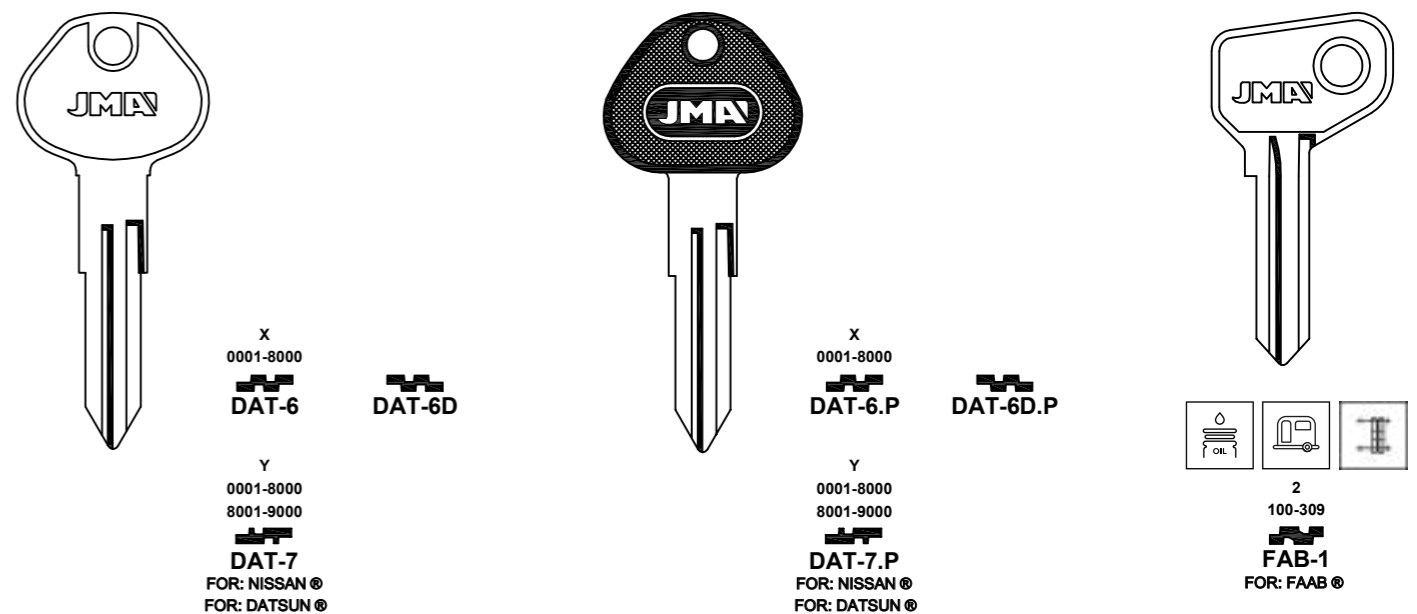

Concerning the marks and commercial denominations see legal warning.
Concerniente a las marcas y denominaciones comerciales ver aviso legal.
Marka eta izendapen komertzialiei dagokienez, ikus lege-oharra.
Concernant les marques et denominations commerciales voir la note dans l'index.

FOR: ALFA ROMEO®

FI-3
 Z-GR
 7001-9956
FI-2D
 G
 2001-4530
 G-Z
 7001-9956
FI-3D
 G
 7001-9956
FI-12
 FOR: GIOBERT®
 FOR: YUGO ZASTAVA® -FIAT IVECO®

FI-2D.P3
 Z-GR
 7001-9956
FI-3D.P3
 G
 2001-4530
 G-Z
 7001-9956
FI-12.P3
 FOR: GIOBERT®

FI-3D.P
 G
 2001-4530
 G-Z
 7001-9956
FI-12.P
 FOR: GIOBERT®

FI-3D.P1
 G
 2001-4530
 G-Z
 7001-9956
FI-12.P1
 FOR: GIOBERT®

FI-3D.P4
 G
 2001-4530
 G-Z
 7001-9956
 FOR: GIOBERT®

FOR: ALFA ROMEO®
 CITROEN®
 FIAT®
 INNOCENTI®
 LANCIA®
 SEAT®

FOR: ALFA ROMEO®

FI-3D.P5
 G
 2001-4530
 G-Z
 7001-9956
 FOR: GIOBERT®

FI-6I
 FOR: GIOBERT®

FI-6I.P1
 FOR: GIOBERT®

FI-6I.P2
 FOR: GIOBERT®

FI-9I
 M
 0001-1050
 FOR: GIOBERT®

FOR: ALFA ROMEO®
 AUTOBIANCHI®
 CITROEN®
 FERRARI®
 FIAT®
 INNOCENTI®
 LANCIA®
 PEUGEOT®
 YUGO ZASTAVA®
 CAGIVA®
 DUCATI®
 FANTIC MOTOR®
 GARELLI®
 GILERA®

K 3301-4886
 K 7001-8092
 T 5000-6027
 T 7001-8092
 S 0501-3278
 H 7001-8092

K 3301-4886
 K 7001-8092
 T 5000-6027
 T 7001-8092
 S 0501-3278
 H 7001-8092

FOR: FERRARI®
 FIAT®
 CAGIVA®

FOR: ALFA ROMEO®

FI-9I.P
 M
 0001-1050
 FOR: GIOBERT®

FI-13
 W
 0001-9640
 FOR: GIOBERT®

FI-13.P
 W
 0001-9640
 FOR: GIOBERT®

FI-13.P1
 W
 0001-9640
 FOR: GIOBERT®

FI-13.P7
 W
 0001-9640
 FOR: GIOBERT®
 FOR: SIPEA®

FOR: ALFA ROMEO®

FI-14.P
 W
 0001-9640
 FOR: GIOBERT®

FI-16.P1
 FOR: TRW-SIPEA®
 FOR: GIOBERT®

GIOB-3.P2
 ALP.
 ALFA ROMEO®
 LA FORZA®
 LANCIA®
 RAYTON FISSORE®
 0001-1530
 FOR: GIOBERT®
 FOR: SAFE®

IMS-3
 0501-1000
AF-21
 0501-1000
IMS-5
 0501-1000
IMS-13
 FOR: SAFE®
 FOR: CROMODORA® -FIST® -MSA®

IMS-3.P
 0501-1000
AF-21.P
 0501-1000
IMS-5.P
 0501-1000
IMS-13.P
 FOR: SAFE®

3
 4
 3
 4
 1
 2
 1
 2

FOR: GIOBERT®

FOR: ALFA ROMEO®

NE-13
E
 E.....
 N.....
 X.....
 1 AL 5
 FOR: NEIMAN®

NE-25
A
D
F
 1 AL 5
 FOR: NEIMAN®

SIP-3
 B.....501-3278
 B.....0-4-6-8-9
 FOR: SIPEA®
 FOR: ARTEB® -CLAUSOR® -NEIMAN®

FOR: AMERICAN MOTORS®

AMM-1
 FOR: AMERICAN MOT.®

AMM-2
 FOR: AMERICAN MOT.®

FOR: AMERICAN MOTORS®

BAS-1I
 E,D
 225-814
 K
 0001-1000
 FOR: BASCO®
 FOR: CORBIN®

BAS-1D
 8000-9499
 FOR: CORBIN®

BS-11
 N
 1501-1700
 NA
 001-200
 FOR: B & S®

BS-2
 E...225-814
 L...1-1000
 FOR: B & S®

BS-5
 D
 225-814
 K
 01-1000
 FOR: B & S®
 FOR: POLLAK® -BOBCAT®

CHR-3

A/Z
 B-C-D-E
 1/9...A/Z
 1/9...A/Z
A/Z
 B-D-E-G-H-J
 .1/9...A/Z
 .1/9...A/Z
 E-M-N-P-R
 FOR: CHRYSLER®
 FOR: CLAUSOR® -NEIMAN®

FOR: A.MOTORS®
 CITROEN®
 MAZDA®
 PEUGEOT®
 RENAULT®
 TALBOT®
 DAF®
 NISSAN®
 PEGASO®



Concerning the marks and commercial denominations see legal warning.
 Concerniente a las marcas y denominaciones comerciales ver aviso legal.
 Marka eta izendapen komertzialiei dagokienez, ikus lege-oharra.
 Concernant les marques et denominations commerciales voir la note dans l'index.

JMA Opening the future

JMA Opening the future

Beziehen auf die marke und handelsname sehen sie die notiz im Impressum.
 Relativamente às marcas e denominações comerciais, ver aviso legal.
 Jeśli chodzi o znaki i nazwy handlowe, patrz Informacje prawne.

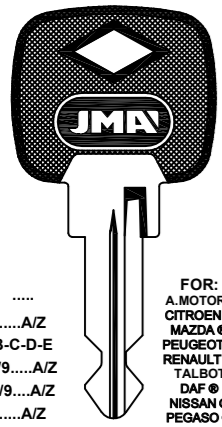
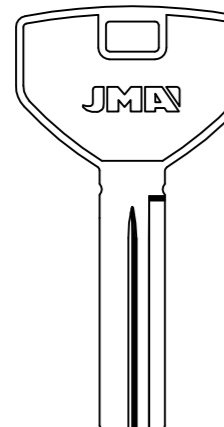
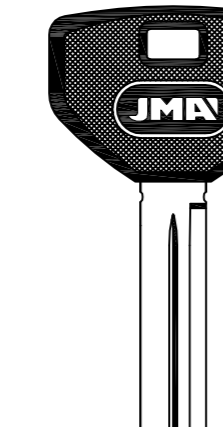
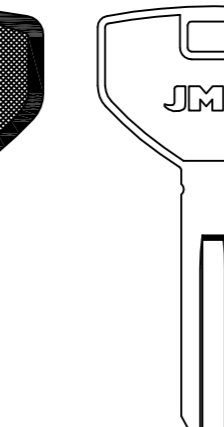

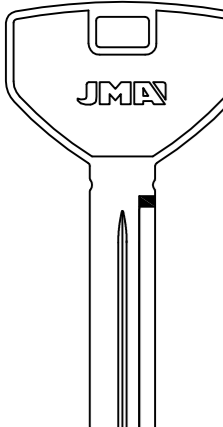
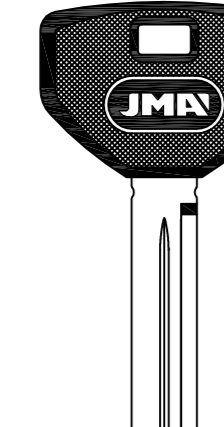

FOR: AMERICAN MOTORS ®

A/Z B-C-D-E 1/9.....A/Z 1/9.....A/ZA/Z B-D-E-G-H-J 1/9.....A/Z 1/9.....A/Z E-M-N-P-R CHR-3.P FOR: CHRYSLER ® FOR: CLAUSOR ® - NEIMAN ®	 JMA F.... G.... 0000-1394 CHR-9 FOR: CHRYSLER ® FOR: YALE ®	 JMA F.... G.... 0000-1394 CHR-9.P FOR: CHRYSLER ® FOR: YALE ®	 JMA J.... 0001-3580 CHR-10 FOR: CHRYSLER ® FOR: YALE ®	 JMA J.... 0001-3580 CHR-10.P FOR: CHRYSLER ® FOR: YALE ®
--	--	--	--	---

FOR: AMERICAN MOTORS ®

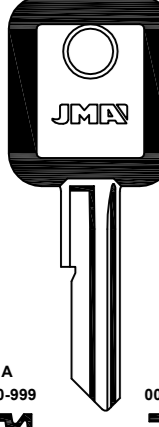
 JMA L.... 1-3580 CHR-14 FOR: CHRYSLER ® FOR: BRIGGS & STRATTON ® - YALE ®	 JMA L.... 1-3580 CHR-14.P FOR: CHRYSLER ® FOR: BRIGGS & STRATTON ® - YALE ®	<table border="0"> <tr> <td style="text-align: center;"> A 000-999 GM-6 E 000-999 GM-8 FOR: G.M. ® FOR: BRIGGS STRATTON ® </td> <td style="text-align: center;"> C 000-999 GM-7 J 000-999 GM-9 FOR: G.M. ® FOR: BRIGGS STRATTON ® </td> </tr> </table>	A 000-999 GM-6 E 000-999 GM-8 FOR: G.M. ® FOR: BRIGGS STRATTON ®	C 000-999 GM-7 J 000-999 GM-9 FOR: G.M. ® FOR: BRIGGS STRATTON ®	<table border="0"> <tr> <td style="text-align: center;"> A 000-999 GM-6.P E 000-999 GM-8.P FOR: G.M. ® FOR: BRIGGS STRATTON ® </td> <td style="text-align: center;"> C 000-999 GM-7.P J 000-999 GM-9.P FOR: G.M. ® FOR: BRIGGS STRATTON ® </td> </tr> </table>	A 000-999 GM-6.P E 000-999 GM-8.P FOR: G.M. ® FOR: BRIGGS STRATTON ®	C 000-999 GM-7.P J 000-999 GM-9.P FOR: G.M. ® FOR: BRIGGS STRATTON ®	<table border="0"> <tr> <td style="text-align: center;"> A 000-999 GM-A E 000-999 GM-E FOR: G.M. ® FOR: BRIGGS STRATTON ® </td> <td style="text-align: center;"> C 000-999 GM-C J 000-999 GM-J FOR: G.M. ® FOR: BRIGGS STRATTON ® </td> </tr> </table>	A 000-999 GM-A E 000-999 GM-E FOR: G.M. ® FOR: BRIGGS STRATTON ®	C 000-999 GM-C J 000-999 GM-J FOR: G.M. ® FOR: BRIGGS STRATTON ®
A 000-999 GM-6 E 000-999 GM-8 FOR: G.M. ® FOR: BRIGGS STRATTON ®	C 000-999 GM-7 J 000-999 GM-9 FOR: G.M. ® FOR: BRIGGS STRATTON ®									
A 000-999 GM-6.P E 000-999 GM-8.P FOR: G.M. ® FOR: BRIGGS STRATTON ®	C 000-999 GM-7.P J 000-999 GM-9.P FOR: G.M. ® FOR: BRIGGS STRATTON ®									
A 000-999 GM-A E 000-999 GM-E FOR: G.M. ® FOR: BRIGGS STRATTON ®	C 000-999 GM-C J 000-999 GM-J FOR: G.M. ® FOR: BRIGGS STRATTON ®									

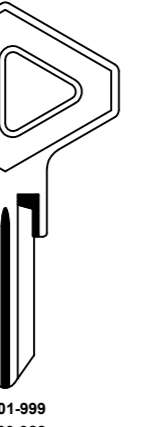
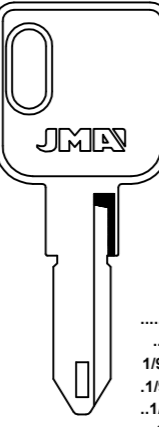

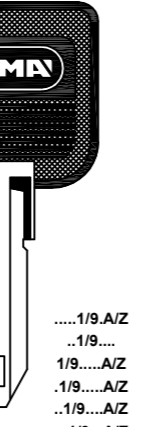
FOR: AMERICAN MOTORS ®

 A 000-999 GM-A.P E 000-999 GM-E.P FOR: G.M. ® FOR: BRIGGS STRATTON ®	 C 000-999 GM-C.P J 000-999 GM-J.P FOR: G.M. ® FOR: BRIGGS STRATTON ®	 T...001-999 V...000-922 2..... 2.....A/Z B-C-D-E-G NE-16 FOR: NEIMAN ® FOR: CLAUSOR ®	1/9.A/Z 1/9..... 1/9.....A/Z 1/9.....A/Z 1/9.....A/Z 1/9.....A/Z 1/9.....A/Z 1/9.....A/Z 1/9.....A/Z 1/9.....A/Z M-N-P-R-S NE-19 FOR: NEIMAN ®	1/9.A/Z 1/9..... 1/9.....A/Z 1/9.....A/Z 1/9.....A/Z 1/9.....A/Z 1/9.....A/Z 1/9.....A/Z 1/9.....A/Z 1/9.....A/Z M-N-P-R-S NE-19.P FOR: NEIMAN ®	1/9.A/Z 1/9..... 1/9.....A/Z 1/9.....A/Z 1/9.....A/Z 1/9.....A/Z 1/9.....A/Z 1/9.....A/Z 1/9.....A/Z 1/9.....A/Z M-N-P-R-S NE-19.P1 FOR: NEIMAN ®
---	--	--	---	---	---

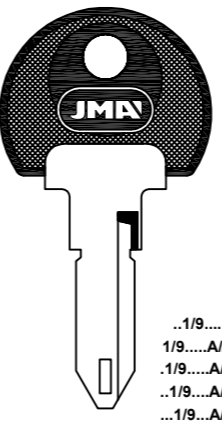
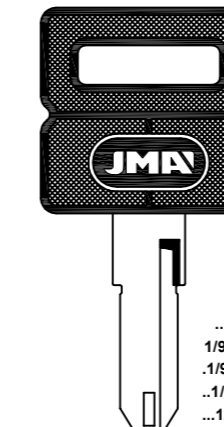
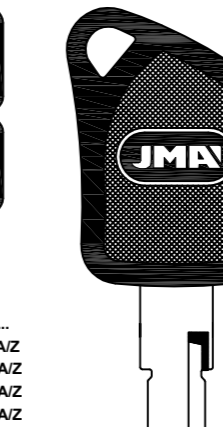
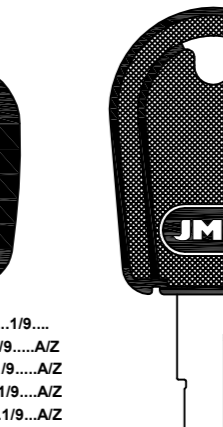
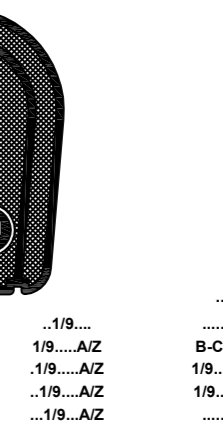
FOR: AMERICAN MOTORS ®

 1/9..... 1/9.....A/Z 1/9.....A/Z 1/9.....A/Z 1/9.....A/Z 1/9.....A/Z 1/9.....A/Z 1/9.....A/Z 1/9.....A/Z M-N-P-R-S NE-20.P FOR: NEIMAN ®	 1/9..... 1/9.....A/Z 1/9.....A/Z 1/9.....A/Z 1/9.....A/Z 1/9.....A/Z 1/9.....A/Z 1/9.....A/Z 1/9.....A/Z M-N-P-R-S NE-20.P1 FOR: NEIMAN ®	 1/9..... 1/9.....A/Z 1/9.....A/Z 1/9.....A/Z 1/9.....A/Z 1/9.....A/Z 1/9.....A/Z 1/9.....A/Z 1/9.....A/Z M-N-P-R-S NE-20.P2 FOR: NEIMAN ®	 1/9..... 1/9.....A/Z 1/9.....A/Z 1/9.....A/Z 1/9.....A/Z 1/9.....A/Z 1/9.....A/Z 1/9.....A/Z 1/9.....A/Z M-N-P-R-S NE-20.P3 FOR: NEIMAN ®	A/Z B-C-D-E 1/9.....A/Z 1/9.....A/Z 1/9.....A/ZA/Z B-D-E-G-H-J 1/9.....A/Z 1/9.....A/Z E-M-N-P-R NE-22.P FOR: NEIMAN ® FOR: CLAUSOR ®
--	---	---	---	---

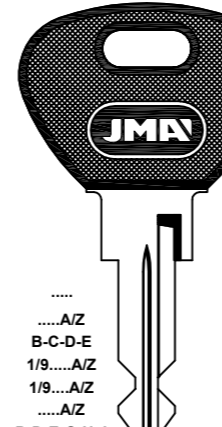
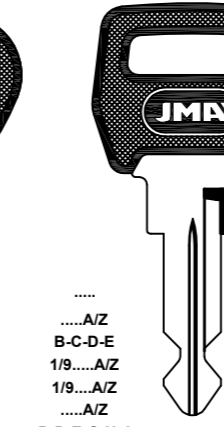
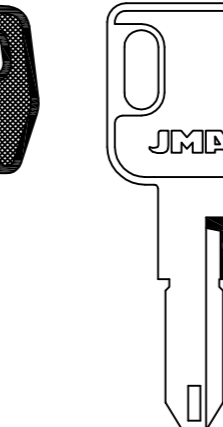
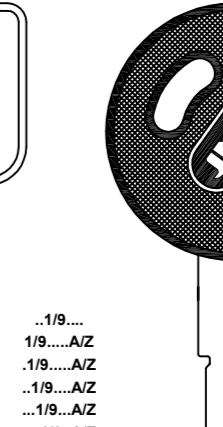
FOR: AMERICAN MOTORS ®

A/Z B-C-D-E 1/9.....A/Z 1/9.....A/Z 1/9.....A/ZA/Z B-D-E-G-H-J 1/9.....A/Z 1/9.....A/Z 1/9.....A/Z E-M-N-P-R NE-22.P1 FOR: NEIMAN ® FOR: CLAUSOR ®	A/Z B-C-D-E 1/9.....A/Z 1/9.....A/Z 1/9.....A/ZA/Z B-D-E-G-H-J 1/9.....A/Z 1/9.....A/Z 1/9.....A/Z E-M-N-P-R NE-22.P2 FOR: NEIMAN ® FOR: CLAUSOR ®	 1/9..... 1/9.....A/Z 1/9.....A/Z 1/9.....A/Z 1/9.....A/Z 1/9.....A/Z 1/9.....A/Z 1/9.....A/Z 1/9.....A/Z M-N-P-R-S NE-36 FOR: NEIMAN ®	 VERDE O NEGRO 1/9..... 1/9.....A/Z 1/9.....A/Z 1/9.....A/Z 1/9.....A/Z 1/9.....A/Z 1/9.....A/Z 1/9.....A/Z 1/9.....A/Z M-N-P-R-S NE-36.P FOR: NEIMAN ®	 1/9..... 1/9.....A/Z 1/9.....A/Z 1/9.....A/Z 1/9.....A/Z 1/9.....A/Z 1/9.....A/Z 1/9.....A/Z 1/9.....A/Z M-N-P-R-S NE-36.P1 FOR: NEIMAN ®
--	--	---	--	--

FOR: AMERICAN MOTORS ®

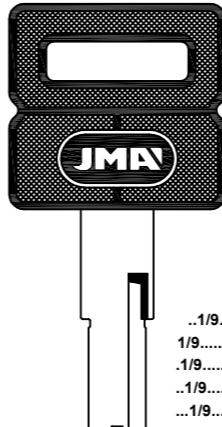
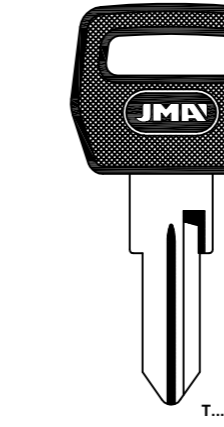
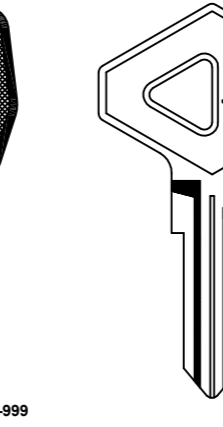
 1/9..... 1/9.....A/Z 1/9.....A/Z 1/9.....A/Z 1/9.....A/Z 1/9.....A/Z 1/9.....A/Z 1/9.....A/Z 1/9.....A/Z M-N-P-R-S NE-39.P FOR: NEIMAN ®	 T...001-999 V...000-922 2..... 2.....A/Z B-C-D-E-G NE-59.P FOR: NEIMAN ® FOR: CLAUSOR ®	 A/Z.....A/ZA/Z 1/9 2700-4816 VA-10 FOR: VACHETTE ®
--	--	---

FOR: ARO DACIA ®

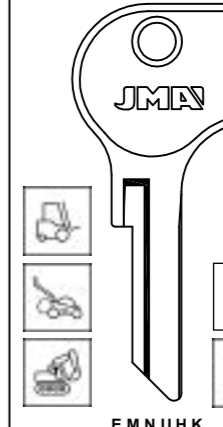
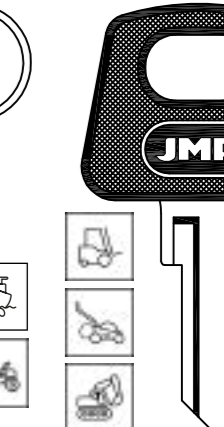
 E,M,N,U,H,K 001-100 HG,N 140-189 HG 040-100 BH-1 FOR: BOSCH ® FOR: NEIMAN ®	 E,M,N,U,H,K 001-100 HG,N 140-189 HG 040-100 BH-1.P FOR: BOSCH ® FOR: NEIMAN ®
---	---

Concerning the marks and commercial denominations see legal warning.
 Concerniente a las marcas y denominaciones comerciales ver aviso legal.
 Marka eta izendapen komertzialiei dagokienez, ikus lege-oharra.
 Concernant les marques et denominations commerciales voir la note dans l'index.

JMA Opening the future

JMA Opening the future

Beziehen auf die Marke und Handelsname sehen sie die Notiz im Impressum.
 Relativamente às marcas e denominações comerciais, ver aviso legal.
 Jeśli chodzi o znaki i nazwy handlowe, patrz Informacje prawne.

FOR: ARO DACIA ®

LAT.

.A/Z....
.A/Z....A/Z
.A/Z....A/Z
0 AL 8
1 AL 7
A/Z....1 AL 7 Y A AL E

NE-4

11-34-39....
1 AL 7
34-39....A/Z
1 AL 7

NE-15I

FOR: NEIMAN ®
FOR: CLAUSSOR ®

.A/Z....
.A/Z....A/Z
.A/Z....A/Z
0 AL 8
1 AL 7
A/Z....1 AL 7 Y A AL E

NE-4.P1

11-34-39....
1 AL 7
34-39....A/Z
1 AL 7

NE-15I.P1

FOR: NEIMAN ®
FOR: CLAUSSOR ®

NE-4D

NE-15D

FOR: NEIMAN ®
FOR: CLAUSSOR ®

HU-1

FOR: HUF ®
FOR: NEIMAN ® - WITTE ® - YMOS ®

FOR: ASTON MARTIN ®

NRA
FFE...1-100
FJA...1-100
FL...251-500
NRA...51-90
YFB...1-75
FMD...1-75
FG...1-30
NF...1-30
EJR...1-75

UN-FFE

MC...1-40
MRA...251-290
MRN...1-54
MRN...201-250
MRN...251-300

UN-MRN

FS...1-99
FS...876-955

UN-1FS

FA...
501-625

UN-44

FOR: UNION ®

HX...100

UN-2

RM...
911-952

UN-44D

FP...
626-750

UN-FP

FR...
751-875

UN-FR

NGN...1-54

UN-NG

FK...
01-99
876-955

UN-FK

FOR: UNION ®
FOR: WBH ®

FS...
01-99
876-955

UN-FS

FT-BC...301-360
BC-FT...101-225
LF...451-575
CB...801-875

UN-FT

TF...1001-1140

UN-TF

FR...4001-6000
FZ...1-1232

WAS-2.P

FOR: WASO ®
FOR: ARMAN ® - DOM ®

FOR: ARO DACIA ®

FOR: ASTON MARTIN ®

70.....
1 AL 3
...1-975

RO-15

FOR: RONIS ®

AK
0001-1000
TC
0001-1000
TX
0001-1859

FO-E/TC

FOR: FORD ®
FOR: CASI ® - CEM ® - CLAUSSOR ® - KOLB ® - NEIMAN ®

AK
0001-1000
TC
0001-1000
TX
0001-1859

FO-E/TC.P

FOR: FORD ®

FOR:
ASTON MARTIN ®
AUTOBIANCHI ®
DAIMLER ®
FIAT ®
JAGUAR ®
JENSEN ®
LOTUS ®
PREMIER ®
SEAT ®
TRIUMPH ®
YUGO ZASTAVA ®

FK
1-3040
4001-6000

FO-FK

FOR: FORD ®

FOR:
ASTON MARTIN ®
AUTOBIANCHI ®
DAIMLER ®
FIAT ®
JAGUAR ®
JENSEN ®
LOTUS ®
PREMIER ®
SEAT ®
TRIUMPH ®
YUGO ZASTAVA ®

FR
1-3040
4001-6000

FO-FR

FOR: FORD ®

FOR:
ASTON MARTIN ®
AUTOBIANCHI ®
DAIMLER ®
FIAT ®
JAGUAR ®
JENSEN ®
LOTUS ®
PREMIER ®
SEAT ®
TRIUMPH ®
YUGO ZASTAVA ®

FR
1-3040
4001-6000

FO-FR.P

FOR: FORD ®

FOR: ARMAN ® - DOM ® - JUGODENT ® - WASO ®

FOR: AUDI ®

FOR:
AKS ®
CASI ®
NEIMAN ®
UBE ®
WITTE ®
YMOS ®

HV....
1-854
1001-9282

AU-1

FOR: HUF ®

AH
001-854
1001-1918
2001-2830
3001-3890
4001-5151
6001-7086
7001-8154
8201-9282

AU-AH

FOR: HUF ®

FOR: AKS ® - CASI ® - UBE ® - WITTE ®

AH
001-854
1001-1918
2001-2830
3001-3890
4001-5151
6001-7086
7001-8154
8201-9282

AU-AH.P

FOR: HUF ®

FOR: AKS ® - CASI ® - UBE ® - WITTE ®

AH....
1-8154
1001-9282

AU-AH.P1

FOR: HUF ®
FOR: WITTE ®

AN
001-854
1001-1918
2001-2830
3001-3890
4001-5151
6001-7086
7001-8154
8201-9282

AU-AN

FOR: HUF ®
FOR: AKS ® - CASI ® - UBE ® - WITTE ®

FOR: ASTON MARTIN ®

FOR: AUDI ®

AK
0001-1000
TC
0001-1000
TX
0001-1859

FO-TX

FOR: FORD ®
FOR: CASI ® - CEM ® - CLAUSSOR ® - KOLB ® - NEIMAN ®

AK
0001-1000
TC
0001-1000
TX
0001-1859

FO-TX.P

FOR: FORD ®

FOR:
ASTON MARTIN ®
JAGUAR ®
LAND ROVER ®
MG ®
ROVER ®
VOLVO ®

FK
01-99
876-955

IN-5

FOR: UNION ®

H....
WH....
0001-3000

IN-1

FS
01-99
876-955

IN-4

FR
751-875

UN-4

LAT.

FOR:
ASTON MARTIN ®
GM ®
HOLDEN ®
IRMSCHER ®
OPEL ®
VAUXHALL ®

H....
WH....
0001-3000

7.18
2.95

OP-WH.P

WY....
Y....
0001-3000

6.88
2.95

OP-WY.P

FOR: HUF ®
FOR: YMOS ®

AN
001-854
1001-1918
2001-2830
3001-3890
4001-5151
6001-7086
7001-8154
8201-9282

AU-AN.P

FOR: HUF ®
FOR: AKS ® - CASI ® - UBE ® - WITTE ®

C
01-32/01-62

AU-C

FOR: HUF ®
FOR: AKS ®

FOR:
AKS ®
CASI ®
NEIMAN ®
UBE ®
WITTE ®
YMOS ®

HV....
1-854
1001-9282

AU-HV

FOR: HUF ®

FOR:
AKS ®
CASI ®
NEIMAN ®
UBE ®
WITTE ®
YMOS ®

HV....
1-854
1001-9282

AU-HV.P

FOR: HUF ®

FOR:
AKS ®
CASI ®
NEIMAN ®
UBE ®
WITTE ®
YMOS ®

HV....
1-854
1001-9282

AU-HV.P1



FOR: HUF ®

Concerning the marks and commercial denominations see legal warning.
Concerniente a las marcas y denominaciones comerciales ver aviso legal.
Marka eta izendapen komertzialiei dagokienez, ikus lege-oharra.
Concernant les marques et dénominations commerciales voir la note dans l'index.

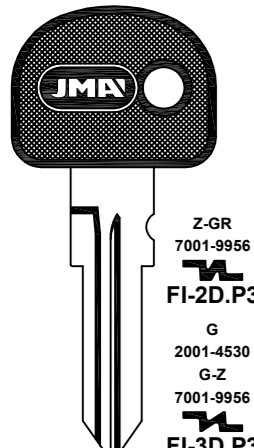
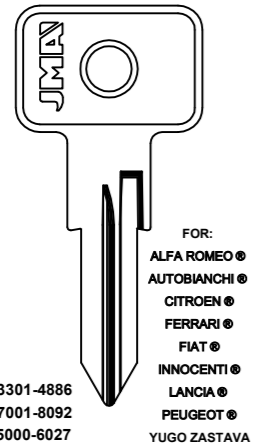
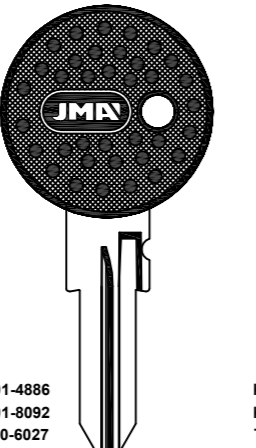
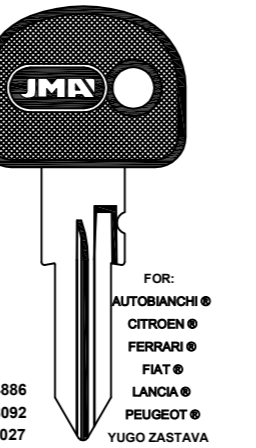
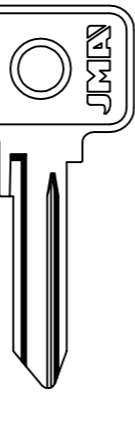
FOR: AUTOBIANCHI®

 <p>Z-GR 7001-9956 FI-2D.P3 G 2001-4530 G-Z 7001-9956 FI-3D.P3 G 7001-9956 FI-12.P3 FOR: GIOBERT®</p>	 <p>FOR: ALFA ROMEO® AUTOBIANCHI® CITROEN® FERRARI® FIAT® INNOCENTI® LANCIA® PEUGEOT® YUGO ZASTAVA® CAGIVA® DUCATI® FANTIC MOTOR® GARELLI® GILERA®</p> <p>K 3301-4886 K 7001-8092 T 5000-6027 T 7001-8092 S 0501-3278 H 7001-8092</p> <p>FI-6I FOR: GIOBERT®</p>	 <p>K 3301-4886 K 7001-8092 T 5000-6027 T 7001-8092 S 0501-3278 H 7001-8092</p> <p>FI-6I.P2 FOR: GIOBERT®</p>	 <p>FOR: AUTOBIANCHI® CITROEN® FERRARI® FIAT® LANCIA® PEUGEOT® YUGO ZASTAVA® CAGIVA® DUCATI® FANTIC MOTOR® GARELLI® GILERA®</p> <p>K 3301-4886 K 7001-8092 T 5000-6027 T 7001-8092 S 0501-3278 H 7001-8092</p> <p>FI-6I.P3 FOR: GIOBERT®</p>	 <p>Y 7001-9956 FI-8I FOR: GIOBERT® FOR: ARMAN®</p>
--	--	---	---	---

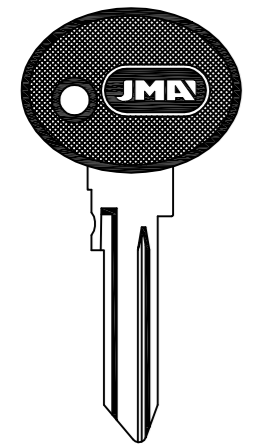
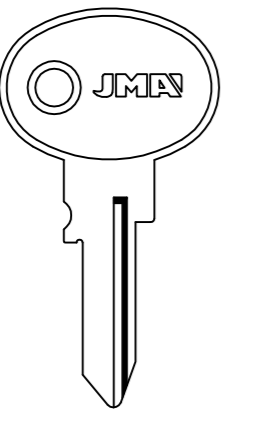
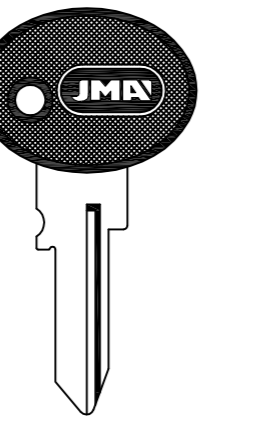
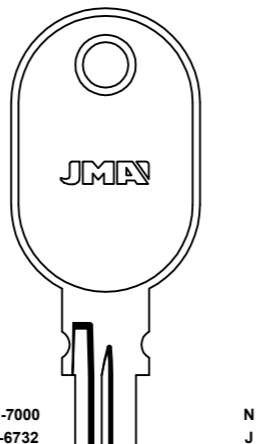
FOR: AUTOBIANCHI®

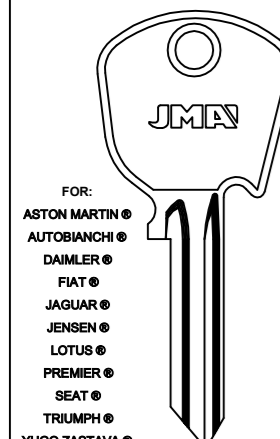
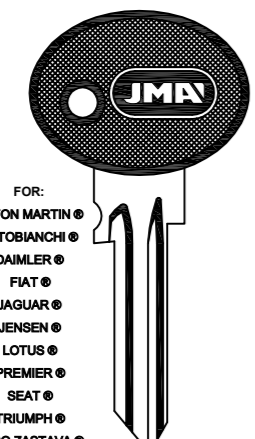
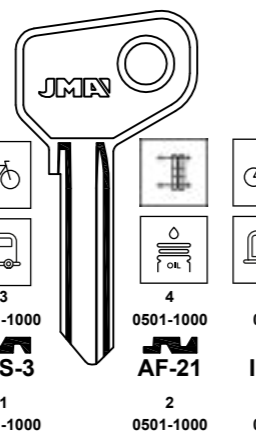
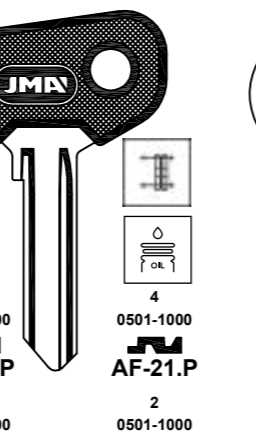
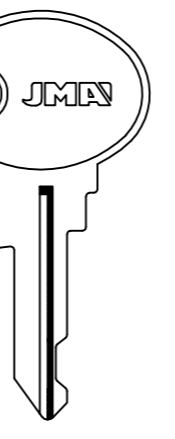
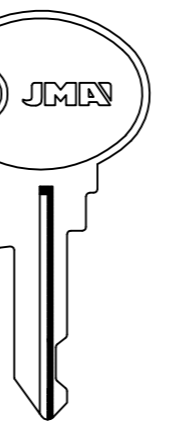
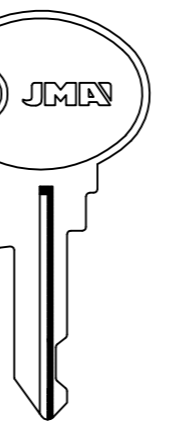

 <p>Y 7001-9956 FI-8I.P FOR: GIOBERT® FOR: ARMAN®</p>	 <p>M 0001-1050 FI-9I FOR: GIOBERT®</p>	 <p>M 0001-1050 FI-9I.P FOR: GIOBERT®</p>	 <p>N 6001-7000 J 3001-6732 V 0001-3051 V 5001-8058 AB 6001-6891 FI-11 FOR: GIOBERT®</p>	 <p>N 6001-7000 J 3001-6732 V 0001-3051 V 5001-8058 AB 6001-6891 FI-11.P FOR: GIOBERT®</p>
---	--	--	--	---

FOR: AUTOBIANCHI®

 <p>FOR: ASTON MARTIN® AUTOBIANCHI® DAIMLER® FIAT® JAGUAR® JENSEN® LOTUS® PREMIER® SEAT® TRIUMPH® YUGO ZASTAVA® SCANIA® FK 1-3040 4001-6000 FO-FK FOR: FORD®</p>	 <p>FOR: ASTON MARTIN® AUTOBIANCHI® DAIMLER® FIAT® JAGUAR® JENSEN® LOTUS® PREMIER® SEAT® TRIUMPH® YUGO ZASTAVA® SCANIA® FK 1-3040 4001-6000 FO-FR FOR: FORD®</p>	 <p>3 0501-1000 IMS-3 FOR: SAFE®</p>	 <p>4 0501-1000 AF-21 FOR: SAFE®</p>	 <p>3 0501-1000 IMS-5.P FOR: SAFE®</p>	 <p>4 0501-1000 AF-19.P FOR: SAFE®</p>	 <p>B....501-3278 B.....0-4-6-8-9 SIP-3 FOR: SIPEA®</p>
---	--	--	---	--	--	---

FOR: ARMAN®-DOM®-JUGODENT®-WASO® FOR: ARMAN®-DOM®-JUGODENT®-WASO® FOR: CROMODORA®-FIST®-JMSA® FOR: CROMODORA®-FIST®-JMSA® FOR: ARTEB®-CLAUSOR®-NEIMAN®

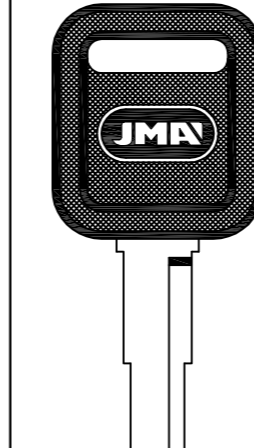
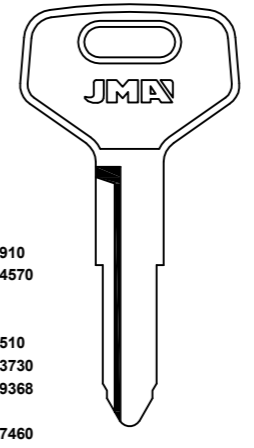
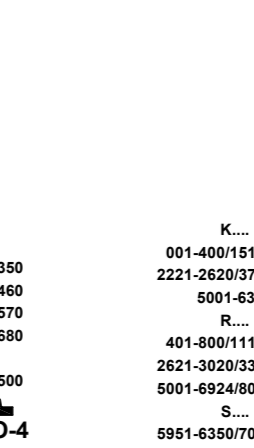
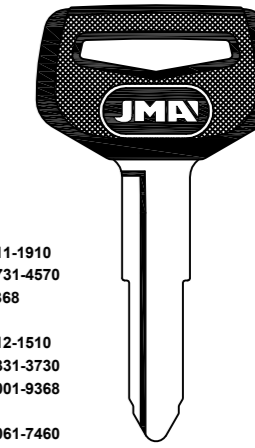
FOR: BEDFORD®

 <p>U 7001-8200 GM-1.P FOR: G.M.® FOR: BRIGGS STRATTON®</p>	 <p>K.... 001-400/1511-1910 2221-2620/3731-4570 5001-6368 R.... 401-800/1112-1510 2621-3020/3331-3730 5001-6924/8001-9368 S.... 5951-6350/7061-7460 8171-8570/9281-9680 D.... 6001-7042 TOYO-K1 FOR: TOYOTA® FOR: TOKAJ®-RIKA®</p>	 <p>F.... 5951-6350 7061-7460 8171-8570 9281-9680 P.... 7001-8500 TOYO-4 C.... 6001-7042 TOYO-14</p>	 <p>K.... 001-400/1511-1910 2221-2620/3731-4570 5001-6368 R.... 401-800/1112-1510 2621-3020/3331-3730 5001-6924/8001-9368 S.... 5951-6350/7061-7460 8171-8570/9281-9680 D.... 6001-7042 TOYO-K1.P FOR: TOYOTA® FOR: TOKAJ®-RIKA®</p>	 <p>F.... 5951-6350 7061-7460 8171-8570 9281-9680 P.... 7001-8500 TOYO-4.P C.... 6001-7042 TOYO-14.P</p>
---	--	---	--	---

FOR: BELLIER®

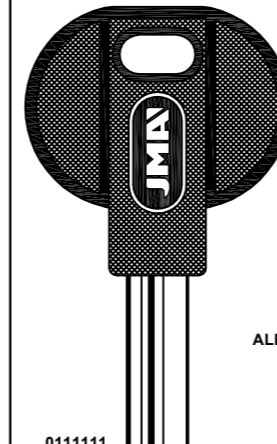

0111111
AL
628888
SIX-3.P
FOR: SIMPLEX®

FOR: BENTLEY®

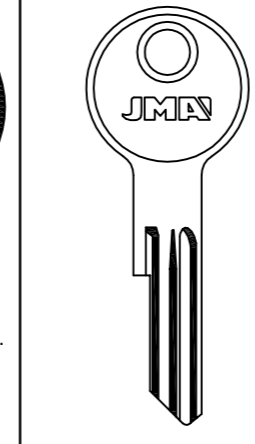
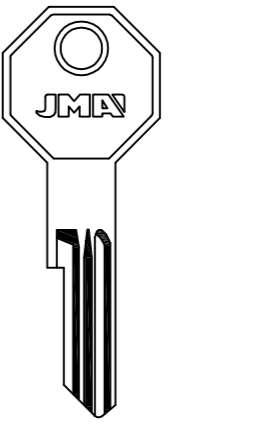
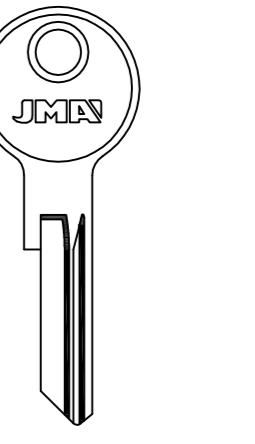
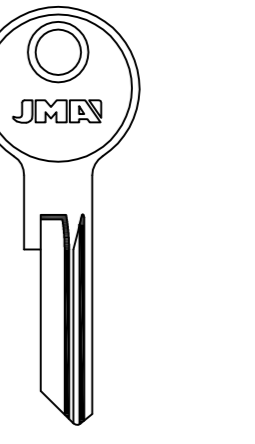
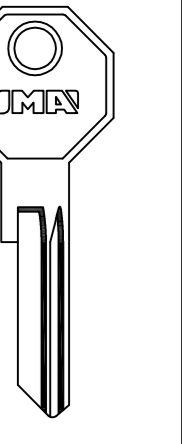
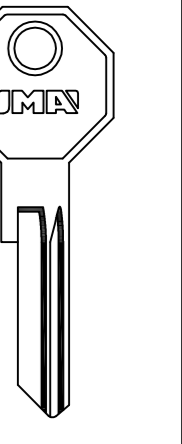
 <p>RRL YA-18D FOR: YALE®</p>	 <p>RRM YA-19D FOR: YALE®</p>	 <p>NRRL YA-20I FOR: YALE®</p>	 <p>NRRL YA-20D FOR: YALE®</p>	 <p>NRRM YA-21I FOR: YALE®</p>	 <p>NRRM YA-21D FOR: YALE®</p>
--	--	---	---	---	---

FOR: BERTONE®

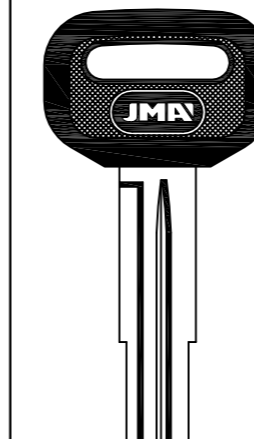
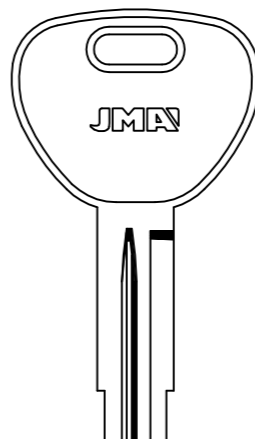
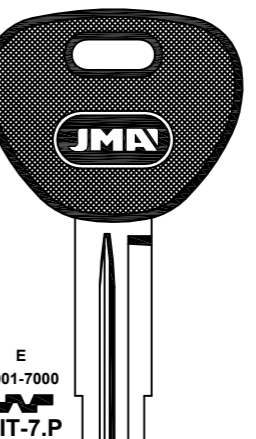
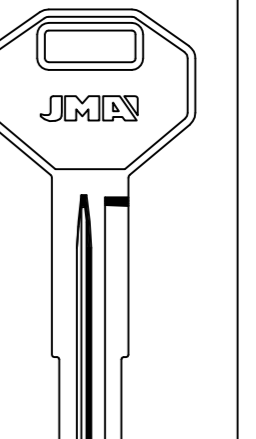
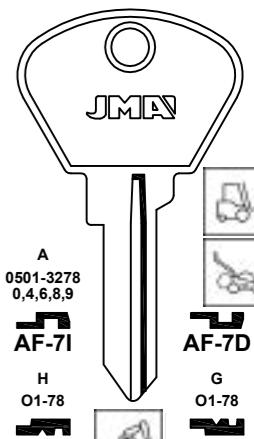
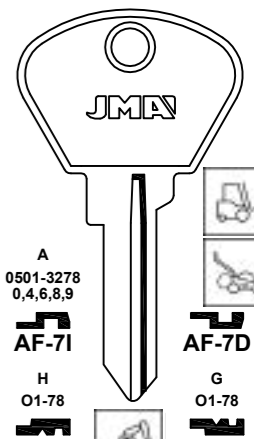
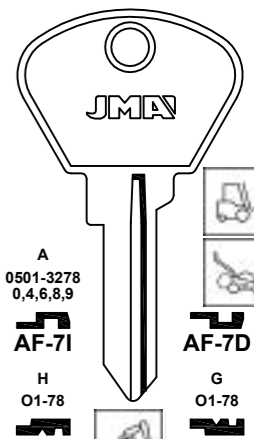
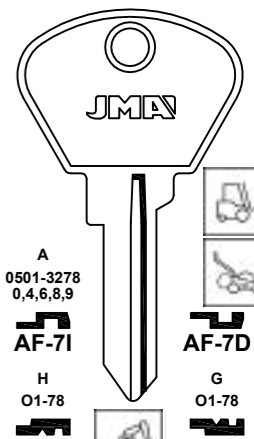
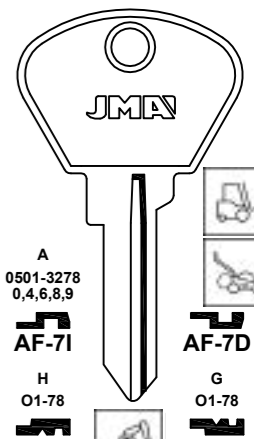
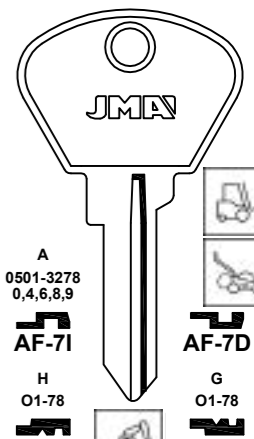
 <p>D 0001-2000 DAI-1.P FOR: DAIHATSU®</p>	 <p>E 5001-7000 MIT-7 FOR: MITSUBISHI®</p>	 <p>E 5001-7000 7001-7679 MIT-15.P FOR: MITSUBISHI®</p>	 <p>E 5001-7679 MIT-12 FOR: MITSUBISHI®</p>	 <p>A 0501-3278 0,4,6,8,9 AF-7I FOR: SIPEA®</p>	 <p>G 01-78 AF-7D FOR: SIPEA®</p>	 <p>H 01-78 AF-8I FOR: SIPEA®</p>	 <p>G 01-78 AF-8D FOR: SIPEA®</p>	 <p>F 01-78 AF-9I FOR: SIPEA®</p>	 <p>E 01-78 AF-9D FOR: SIPEA®</p>
--	--	---	---	---	---	---	---	---	---

FOR: BMA®

Concerning the marks and commercial denominations see legal warning.
Concerniente a las marcas y denominaciones comerciales ver aviso legal.
Marka eta izendapen komertzialiei dagokienez, ikus lege-oharra.
Concernant les marques et denominations commerciales voir la note dans l'index.

JMA Opening the future

JMA Opening the future

Beziehen auf die marke und handelsname sehen sie die notiz im Impressum.
Relativamente às marcas e denominações comerciais, ver aviso legal.
Jeśli chodzi o znaki i nazwy handlowe, patrz Informacje prawne.

FOR: BMA®

A
0501-3278
0,4,6,8,9
AF-71.P
H
01-78
AF-81.P
F
01-78
AF-91.P
FOR: SIPEA®
FOR: SAFE®

F
01-78
FEM-11
H
01-78
FEM-21
E
01-78
FEM-1D
G
01-78
FEM-2D
E
01-78
FEM-3D
FOR: FEMSA®

NRA
FFE...1-100
FJA...1-100
FL...251-500
NRA...51-90
YFB...1-75
FMD...1-75
FG...1-30
NF...1-30
EJR...1-75
UN-FFE
UN-3
UN-FP
MC...1-40
MRA...251-290
MRN...1-54
MRN...201-250
MRN...251-300
UN-MRN
UN-2
UN-FR
FA...
501-625
UN-44
FOR: UNION®

FP...
626-750
UN-FP
FR...
751-875
UN-FR
HX...100
UN-2
UN-FR
RM...
911-952
UN-44D
UN-NG
NGN...1-54
UN-NG
FOR: UNION®

FOR: BMW®

ALP.
7.49
2.7
BM-1.P
FOR: HUF®
FOR: PEBRA®
0001-1100

FOR: BMW®

HB 1-5000
BM-HB
FOR: HUF®
NB 1-5000
BM-NB
FOR: HUF®
HB 1-5000
BM-HB.P
FOR: HUF®
NB 1-5000
BM-NB.P
FOR: HUF®
W
1001-2020
7001-8000
BM-W
FOR: HUF®
SE
001-750
SC
401-630
HU-SC
FOR: HUF®
SZ
1-240
HU-SZ
FOR: AKS®
SR
001-240
KSR
001-240
LSR
001-240
TSR
001-240
HU-SR
SU
001-240
401-630
HU-SU
SX
001-240
HU-SX
SY
001-240
HU-SY

FOR: BMW®

HB 10001-20000
40001-49999
BM-2
FOR: HUF®
HB 10001-20000
40001-49999
BM-2.P
FOR: HUF®
FOR: MAKERSAN®
FOR: HUF®
HB 1-5000
BM-3
FOR: HUF®
HB 1-5000
BM-3.P
FOR: HUF®
BH 010001-241009
7.2
3.5
BM-4
FOR: HUF®
FOR: TIBBE®

FOR: BMW (USA)®

LAT.
8.2
2.95
BM-6.P
FOR: HUF®
PARA FOR BM-6RKE TP
ALP.
8.2
2.95
BM-6.P1C1
FOR: HUF®

FOR: BRITISH LEYLAND®

SF...101-199
SR...301-399
SS...201-299
SO...01-99
STR-3
FOR: STREBOR®
FOR: UNION®
FS...1-99
FS...876-955
UN-1FS
NRA
FFE...1-100
FJA...1-100
FL...251-500
NRA...51-90
YFB...1-75
FMD...1-75
FG...1-30
NF...1-30
EJR...1-75
UN-FFE
UN-3
UN-FP
MC...1-40
MRA...251-290
MRN...1-54
MRN...201-250
MRN...251-300
UN-MRN
UN-2
UN-FR
HX...100
UN-2
UN-FR
FR...
751-875
UN-FR
RM...
911-952
UN-44D
UN-NG
NGN...1-54
UN-NG
FOR: UNION®

FOR: BMW®

LAT.
BH 010001
241009
7.2
3.5
BM-5.P
FOR: HUF®
FOR: TIBBE®
LAT.
8.2
2.95
BM-6.P
FOR: HUF®
PARA FOR BM-6RKE TP
ALP.
8.2
2.95
BM-6.P1C1
FOR: HUF®
B
101-300
401-630
BM-B
FOR: HUF®
FOR: WITTE®

FOR: CARBODIES®

FOR: ASTON MARTIN®
JAGUAR®
LAND ROVER
MG®
ROVER®
VOLVO®
FP 626-750
IN-1
FS 01-99
876-955
IN-4
FR 751-875
UN-4
FOR: UNION®
FOR: AUSTIN®
CARBODIES®
INNOCENTI®
LAND ROVER
LOTUS®
MASERATI®
OM IVECO®
ROVER®
VAUXHALL®
BEDFORD®
FIAT IVECO®
FOR: L. & F.®
RO BL...N
1001-2000
LF-RO
FOR: L. & F.®
FK...
01-99
876-955
UN-FK
FOR: UNION®
FOR: WBH®
FS...
01-99
876-955
UN-FS
FOR: UNION®
011111
AL
628888
SIX-3.P
FOR: SIMPLEX®

FOR: CHATENET®

Concerning the marks and commercial denominations see legal warning.
 Concerniente a las marcas y denominaciones comerciales ver aviso legal.
 Marka eta izendapen komertzialiei dagokienez, ikus lege-oharra.
 Concernant les marques et denominations commerciales voir la note dans l'index.

FOR: CHEVROLET®

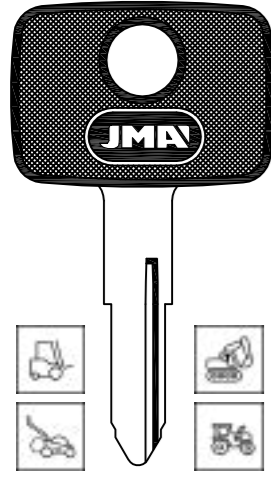

DAE-5.P
FOR: DAEWOO®

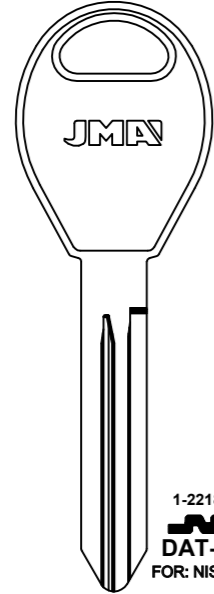

1-22185
DAT-16
FOR: NISSAN®

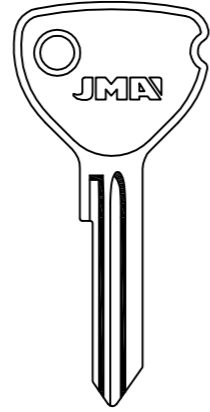

B...1-380
BB...501-1000
BB...1751-2000
BB...2501-3000
OP-BB

CC...501-1000
CC...1751-2000
CC...2501-3000
OP-CC

EE...501-1000
EE...1751-2000
EE...2501-3000
FOR: HUF®
OP-EE

DD...501-1000
DD...1751-2000
DD...2501-3000
OP-DD

FF...501-1000
FF...1751-2000
FF...2501-3000
OP-FF

FOR: CHRYSLER®

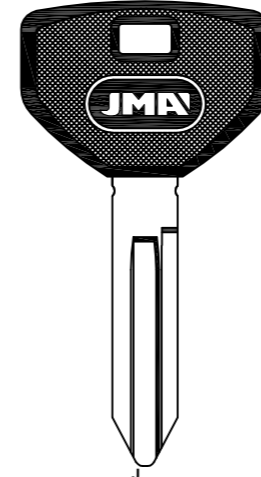

J...
0001-3580
CHR-10.P
FOR: CHRYSLER®
FOR: YALE®

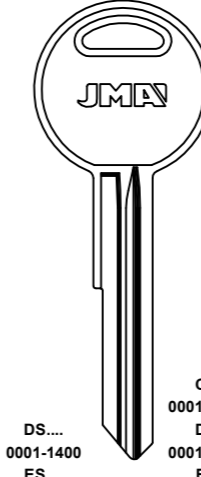

DS...
0001-1400
ES...
0001-3000
CHR-12
FOR: CHRYSLER®
FOR: BRIGGS & STRATTON®

CV
0001-1500
DS
0001-1500
ES
0001-1500
CHR-13D
FOR: CHRYSLER®

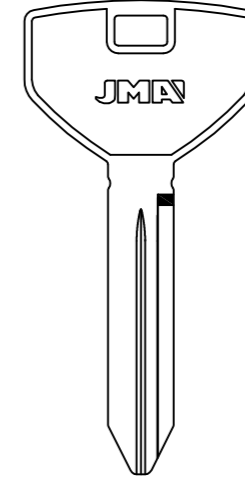

L... 1-3580
CHR-14
FOR: CHRYSLER®
FOR: BRIGGS & STRATTON® -YALE®

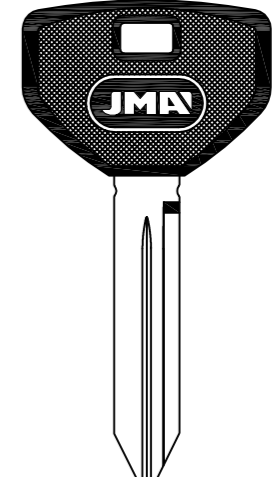

L... 1-3580
CHR-14.P
FOR: CHRYSLER®
FOR: BRIGGS & STRATTON® -YALE®

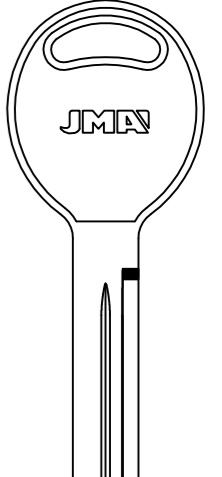

L... 1-3580
CHR-15
FOR: CHRYSLER®
FOR: BRIGGS & STRATTON® -YALE®

FOR: CHRYSLER®

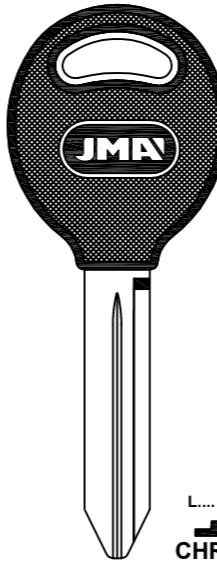

L... 1-3580
CHR-15.P
FOR: CHRYSLER®
FOR: BRIGGS & STRATTON® -YALE®

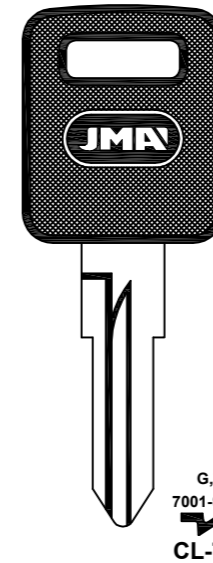

G,Z
7001-9956
CL-7.P
FOR: CLAUSSOR®
FOR: GIOBERT®

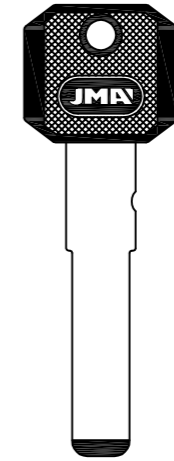

FI-16.P1
FOR: TRW-SIPEA®
FOR: GIOBERT®

LAT.

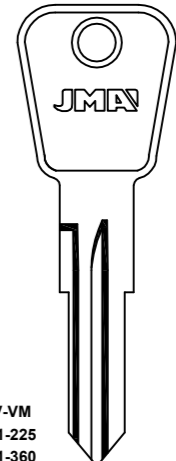

FV-VM
101-225
301-360
VT...
400-474
LF-6
FOR: L. & F.®

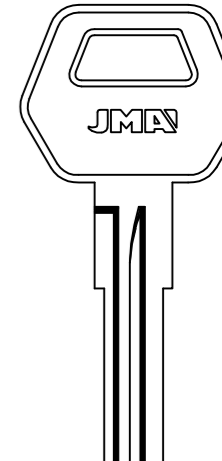

SL
5001-7000
LF-SL
FOR: L. & F.®
FOR: ROOTES®

FOR: CHRYSLER®

FOR: CHEVROLET®

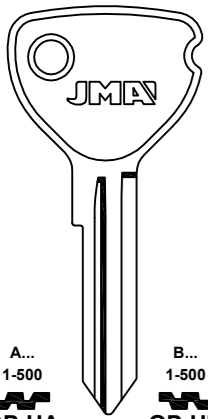

A...
1-500
OP-HA

B...
1-500
OP-HB

A...
1-500
OP-NA
FOR: HUF®
FOR: YMOS®

B...
1-500
OP-NB

FOR: CHEVROLET (KR)®

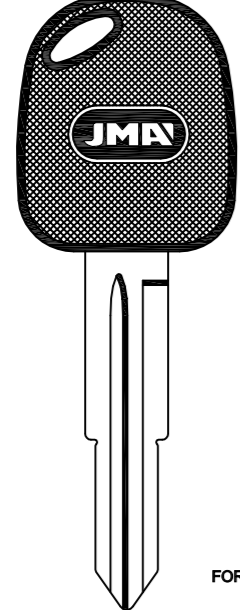

DAE-3.P2
FOR: DAEWOO®

J...
1-1200
DAE-3D.P2

FOR: CHRYSLER®

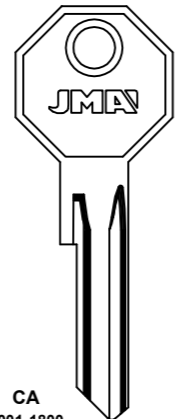

CA
0001-1800
BAS-2I

BAS-2D
D,C,P,D
BAS-3
FOR: BASCO®
FOR: CORBIN® -YALE®

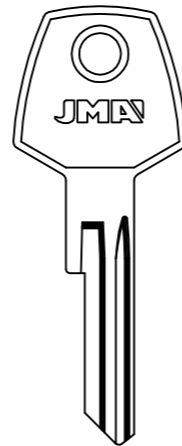

CHR-1
FOR: CHRYSLER®
FOR: YALE®

FOR: CHRYSLER®

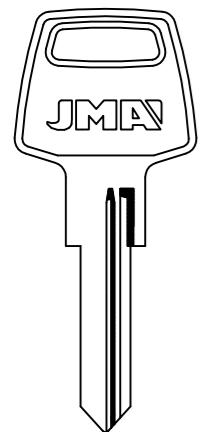

CHR-2
FOR: CHRYSLER®
FOR: ROSS®

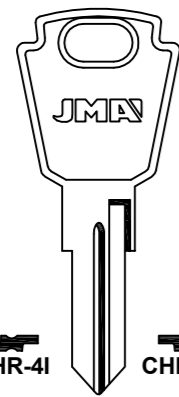

CHR-4I
RO-1IS



CHR-4D
RO-1DS
C
001-224
RO-3

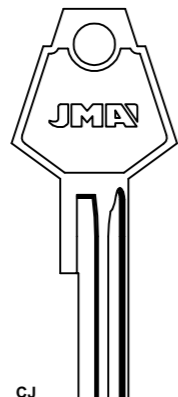

CJ
001-500
DP
0001-1400
EP
0001-3000
CHR-7
FOR: CHRYSLER®
FOR: YALE®



DP
0001-1400
EP
0001-3000
CHR-8
FOR: CHRYSLER®
FOR: YALE®

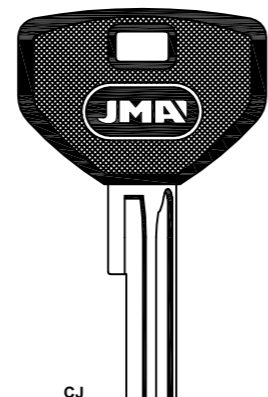

CJ
001-500
DP
0001-1400
EP
0001-3000
CHR-7.P
FOR: CHRYSLER®
FOR: YALE®

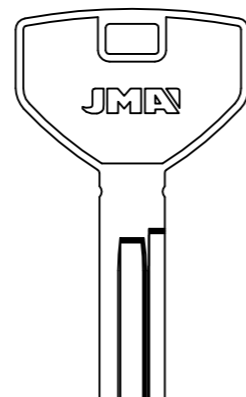

J...
0001-3580
CHR-10
FOR: CHRYSLER®
FOR: YALE®

FOR: CHRYSLER®

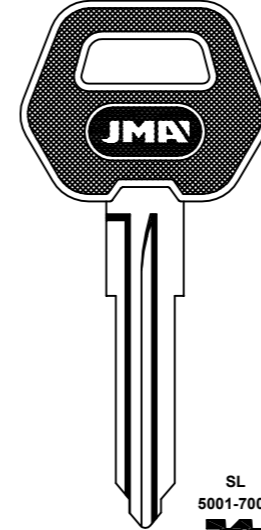

SL
5001-7000
LF-SL.P
FOR: L. & F.®
FOR: ROOTES®

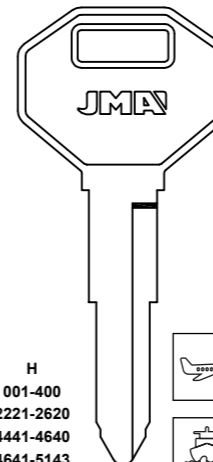

H
001-400
2221-2620
4441-4640
4641-5143
E
2001-3000
MIT-11
FOR: MITSUBISHI®



MIT-1D

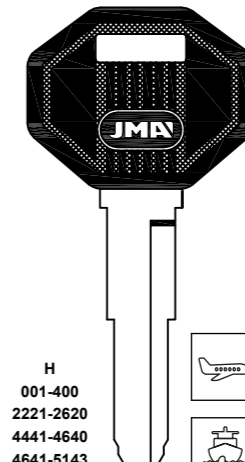

H
001-400
2221-2620
4441-4640
4641-5143
E
2001-3000
MIT-11.P
FOR: MITSUBISHI®

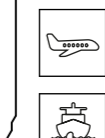

MIT-1D.P

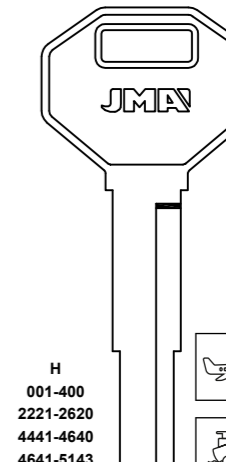

H
001-400
2221-2620
4441-4640
4641-5143
E
2001-3000
MIT-21
FOR: MITSUBISHI®

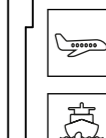

MIT-2D

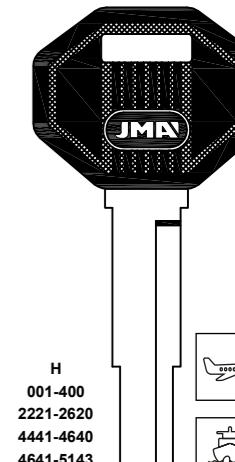

H
001-400
2221-2620
4441-4640
4641-5143
E
2001-3000
MIT-21.P
FOR: MITSUBISHI®

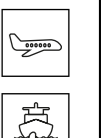

MIT-2D.P

Concerning the marks and commercial denominations see legal warning.
Concerniente a las marcas y denominaciones comerciales ver aviso legal.
Marka eta izendapen komertzialiei dagokienez, ikus lege-oharra.
Concernant les marques et dénominations commerciales voir la note dans l'index.

FOR: CHRYSLER®

FOR: CITROEN®

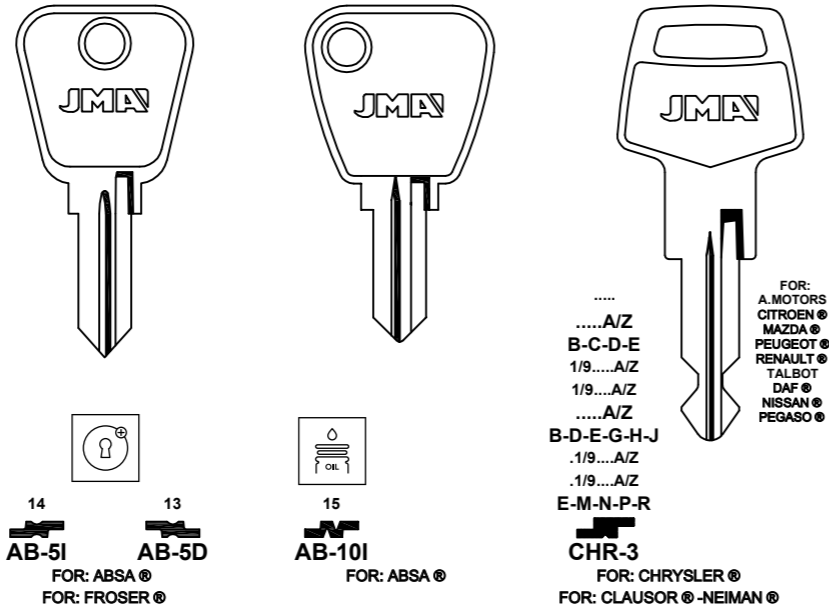
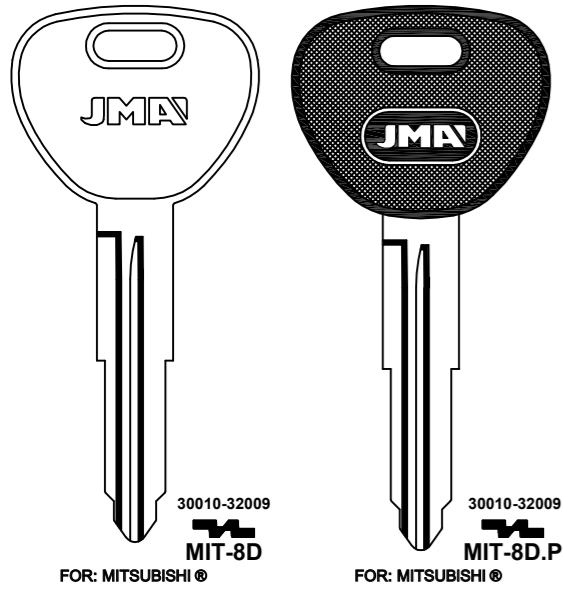

FOR: CITROEN®

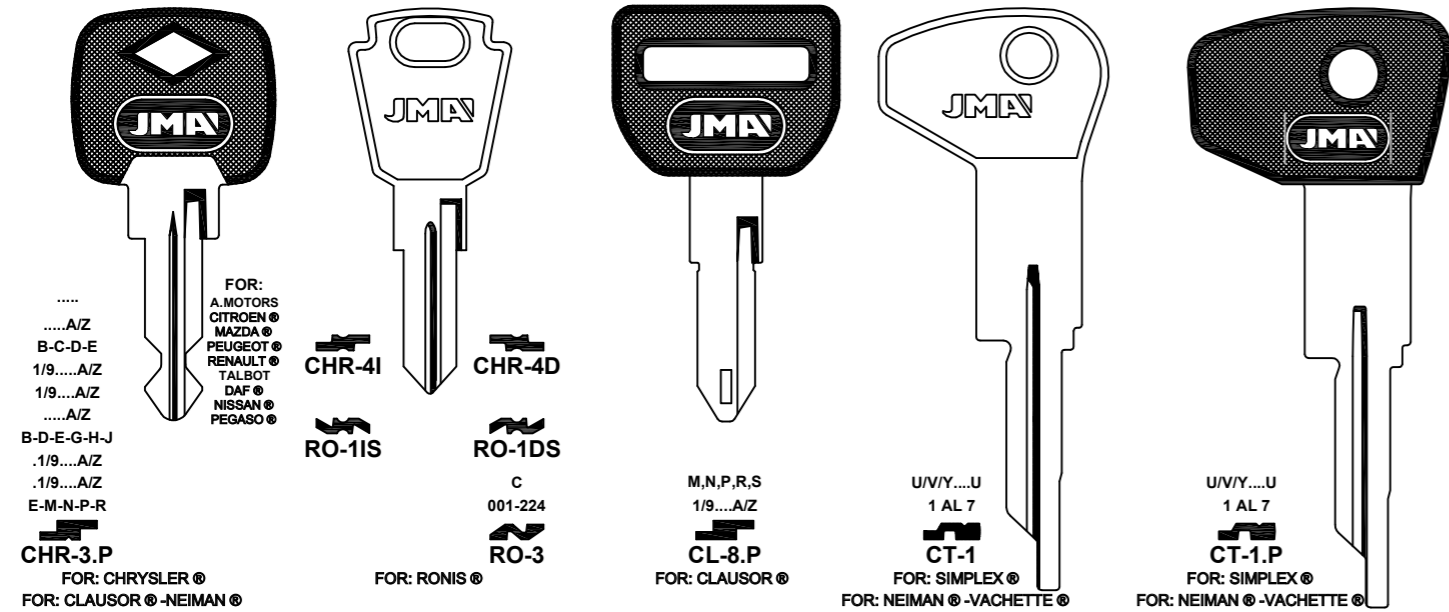

FOR: CITROEN®

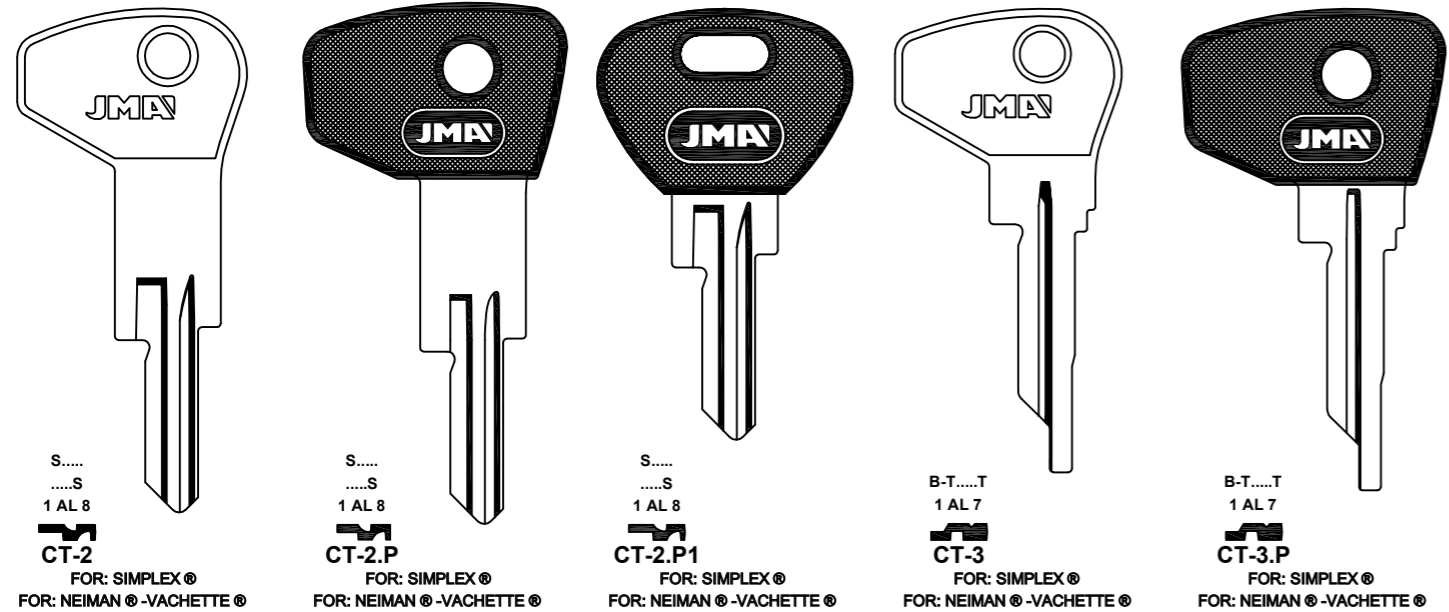

FOR: CITROEN®

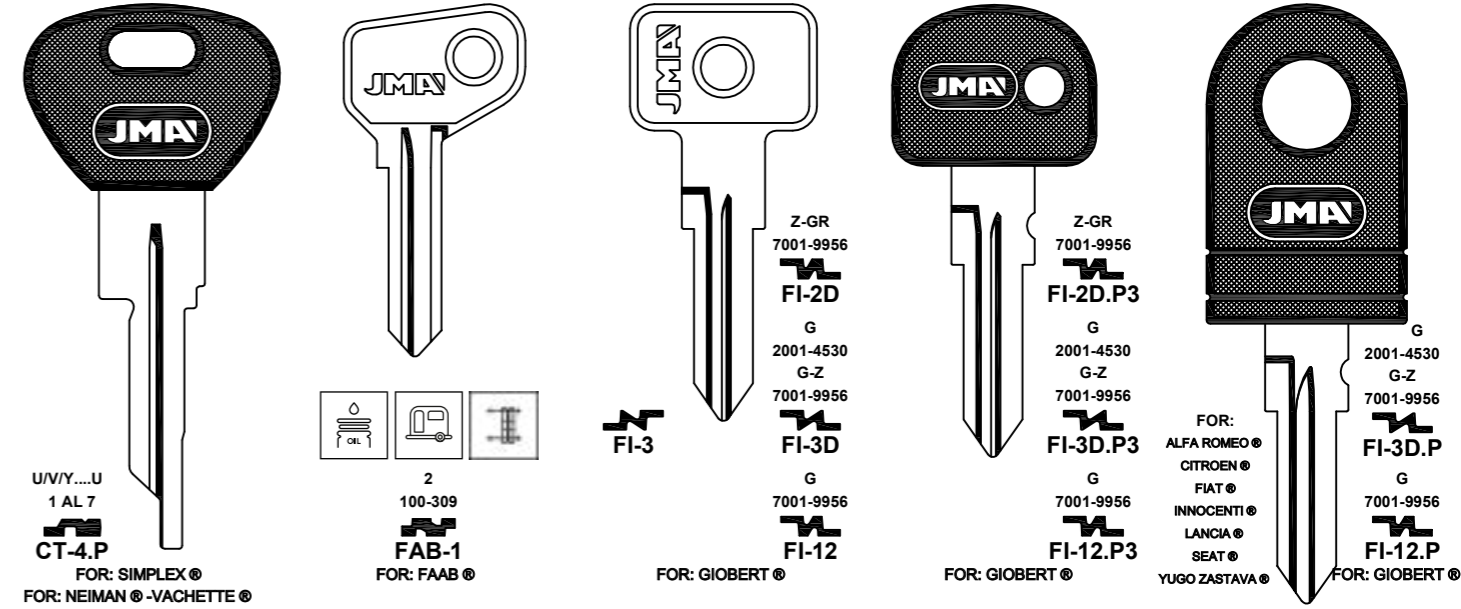

FOR: CITROEN®

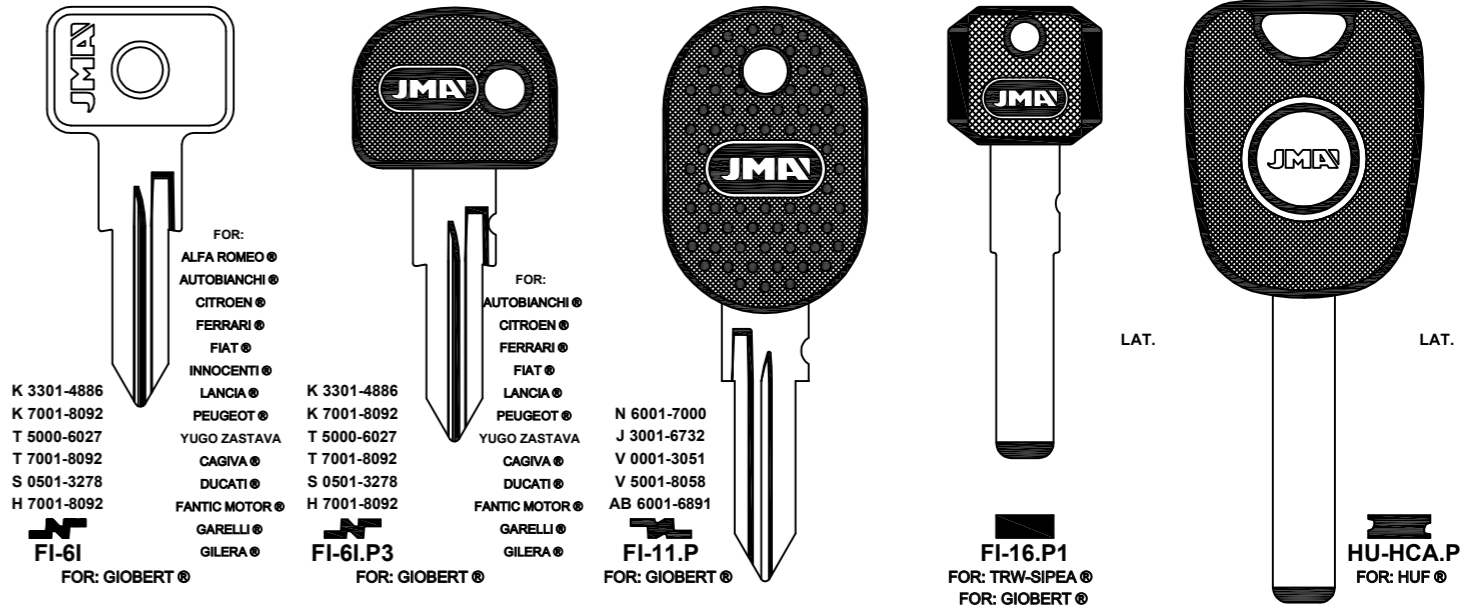

FOR: CITROEN®

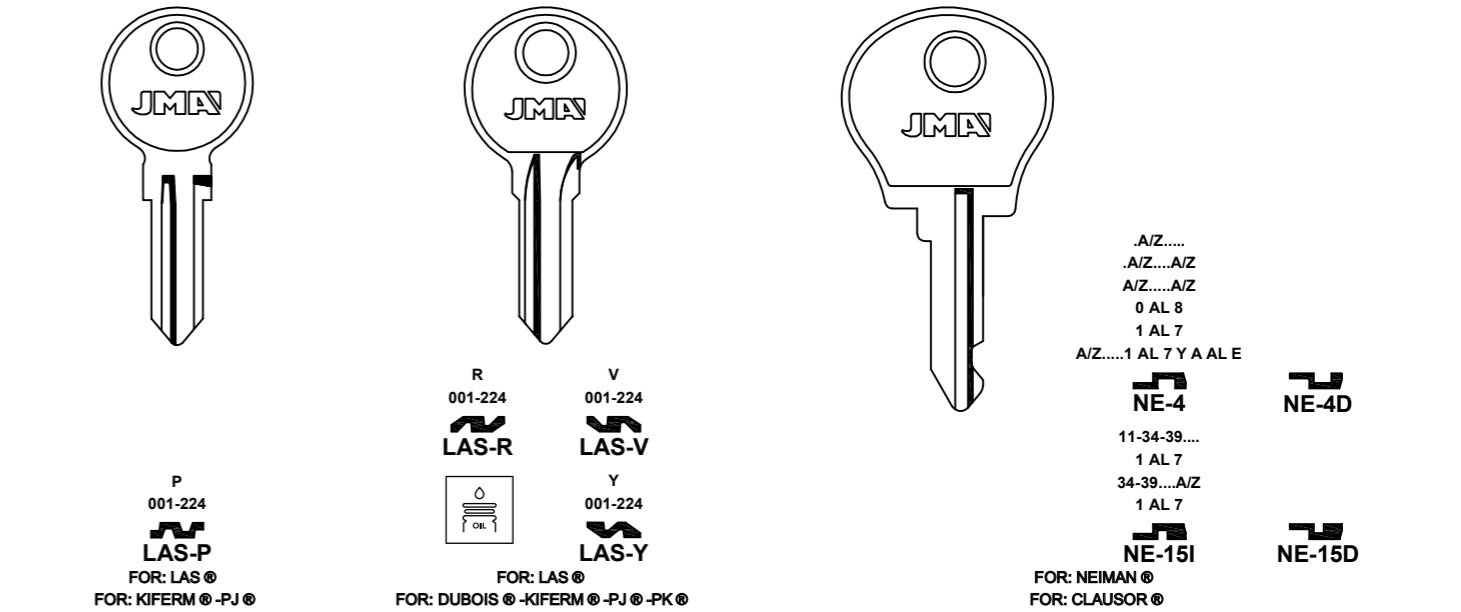

Concerning the marks and commercial denominations see legal warning.
Concerniente a las marcas y denominaciones comerciales ver aviso legal.
Marka eta izendapen komertzialiei dagokienez, ikus lege-oharra.
Concernant les marques et denominations commerciales voir la note dans l'index.

JMA Opening the future

JMA Opening the future

Beziehen auf die marke und handelsname sehen sie die notiz im Impressum.
Relativamente às marcas e denominações comerciais, ver aviso legal.
Jeśli chodzi o znaki i nazwy handlowe, patrz Informacje prawne.

FOR: CITROEN ®

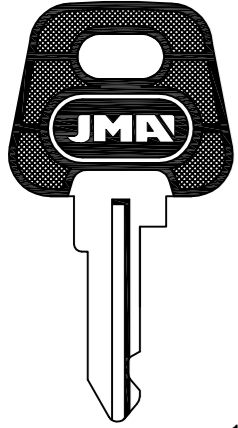

.A/Z.....
A/Z...A/Z
A/Z...A/Z
0 AL 8
1 AL 7
A/Z...1 AL 7 Y A A L E

NE-4.P
11-34-39...
1 AL 7
34-39...A/Z
1 AL 7
NE-15I.P
FOR: NEIMAN ®
FOR: CLAUSOR ®

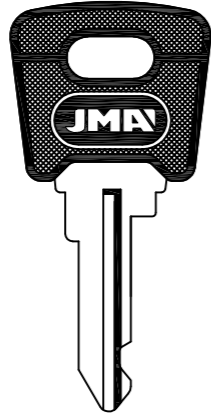

.A/Z.....
A/Z...A/Z
A/Z...A/Z
0 AL 8
1 AL 7
A/Z...1 AL 7 Y A A L E

NE-4.P1
11-34-39...
1 AL 7
34-39...A/Z
1 AL 7
NE-15I.P1
FOR: NEIMAN ®
FOR: CLAUSOR ®

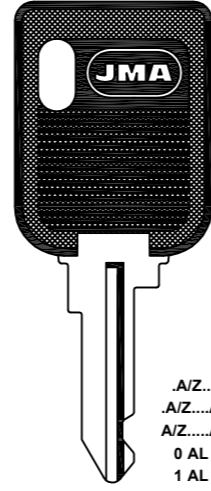

NE-4.P2
A/Z.....
A/Z...A/Z
A/Z...A/Z
0 AL 8
1 AL 7
A/Z...1 AL 7 Y A A L E
FOR: NEIMAN ®
FOR: CLAUSOR ®

FOR: CITROEN ®

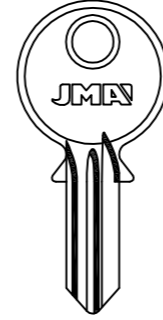

.4AB-ZZ
S...331-348
RO-2I

RO-1I
A8..AA-DS
..8AB-ZZ
S...385-402
FOR: ABSA ® -FROSER ® -PJ ® -SADV ®

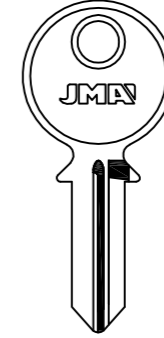

.3AB-ZZ
...1 AL 4
RO-2D

AA-JZ
A4../A.4.
RO-4I
AB-ZZ
..6
S...349-366
RO-6I

FOR: RONIS ®
FOR: ABSA ® -FROSER ® -PJ ® -SADV ®

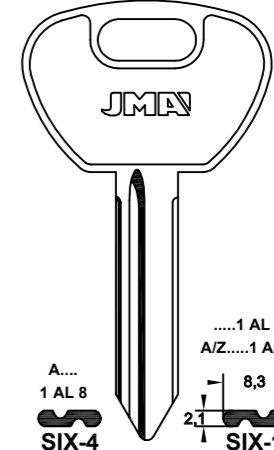

.....1 AL 8
A/Z...1 AL 8
SIX-1



C4..AA-ZY
D4..AA-HR
RO-5I
RO-5D

FOR: RONIS ®
FOR: ABSA ®

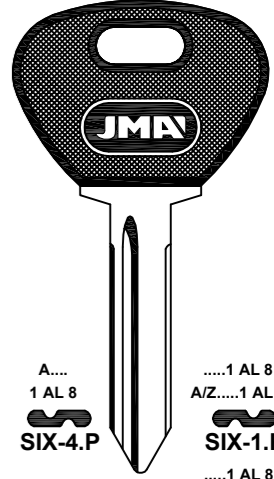

A....
1 AL 8
SIX-4

FOR: SIMPLEX ®
FOR: NEIMAN ®

A....
1 AL 8
SIX-4.P

FOR: SIMPLEX ®
FOR: NEIMAN ®

FOR: CITROEN ®

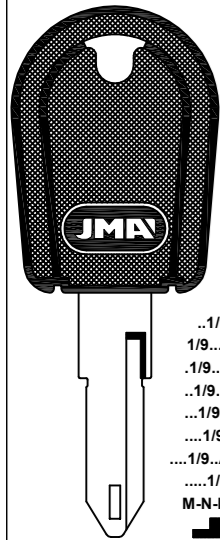

..1/9....
1/9...A/Z
.1/9...A/Z
..1/9...A/Z
..1/9...A/Z
..1/9...A/Z
.....1/9...A/Z
....1/9...A/Z A/Z
.....1/9...A/Z
M-N-P-R-S

NE-20.P3
FOR: NEIMAN ®

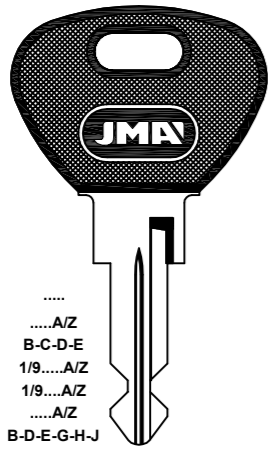

.....
.....A/Z
B-C-D-E
1/9...A/Z
1/9...A/Z
..1/9...A/Z
.....A/Z
B-D-E-G-H-J
1/9...A/Z
..1/9...A/Z A/Z
.1/9...A/Z
E-M-N-P-R

NE-22.P1
FOR: NEIMAN ®
FOR: CLAUSOR ®

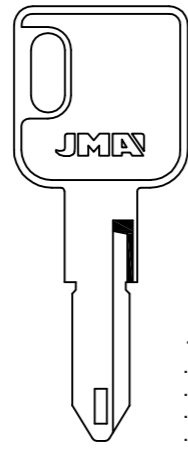

..1/9....
1/9...A/Z
.1/9...A/Z
..1/9...A/Z
..1/9...A/Z
.....1/9...A/Z
....1/9...A/Z A/Z
.....1/9...A/Z
M-N-P-R-S

NE-36
FOR: NEIMAN ®



VERDE O
NEGRO
..1/9....
1/9...A/Z
.1/9...A/Z
..1/9...A/Z
..1/9...A/Z
.....1/9...A/Z
....1/9...A/Z A/Z
.....1/9...A/Z
M-N-P-R-S

NE-36.P
FOR: NEIMAN ®

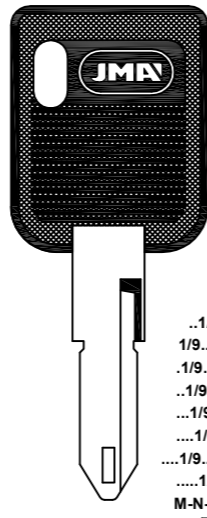

..1/9....
1/9...A/Z
.1/9...A/Z
..1/9...A/Z
..1/9...A/Z
.....1/9...A/Z
....1/9...A/Z A/Z
.....1/9...A/Z
M-N-P-R-S

NE-36.P1
FOR: NEIMAN ®

FOR: CITROEN ®

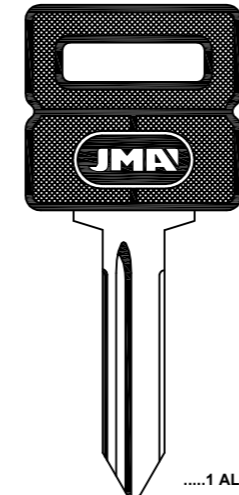

.....1 AL 8
A/Z...1 AL 8
SIX-1.P1

FOR: SIMPLEX ®
FOR: NEIMAN ®

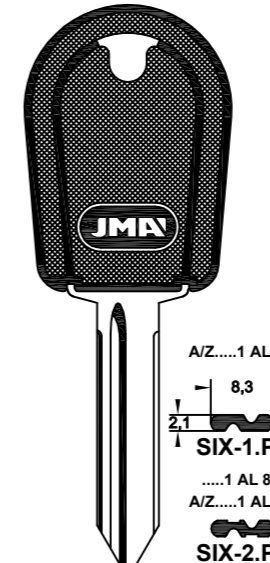

A/Z...1 AL 8
.....1 AL 8
A/Z...1 AL 8
SIX-2.P2

FOR: SIMPLEX ®
FOR: NEIMAN ®

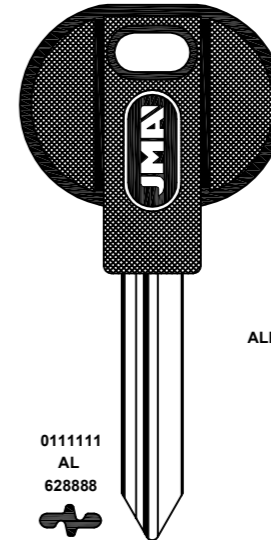

0111111
AL
628888
SIX-3.P

FOR: SIMPLEX ®
FOR: CITROEN ®

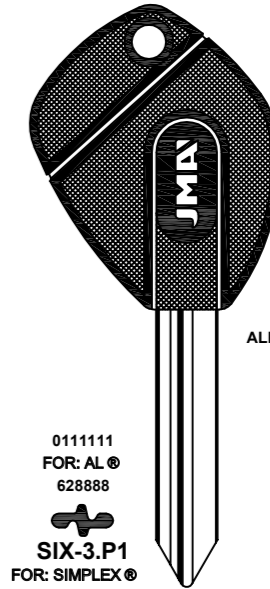

0111111
FOR: AL ®
628888
SIX-3.P1

FOR: SIMPLEX ®

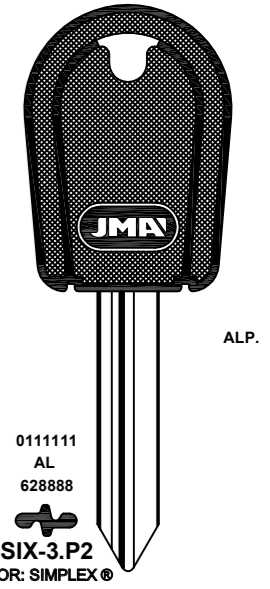

0111111
AL
628888
SIX-3.P2

FOR: SIMPLEX ®

FOR: CITROEN ®

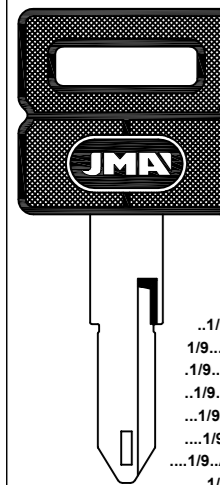

..1/9....
1/9...A/Z
.1/9...A/Z
..1/9...A/Z
..1/9...A/Z
.....1/9...A/Z
....1/9...A/Z A/Z
.....1/9...A/Z
M-N-P-R-S

NE-39.P
FOR: NEIMAN ®

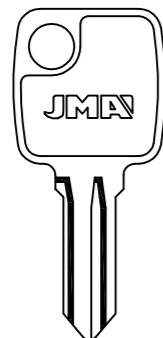

J...
001-224
PJ-2

FOR: PJ ®
FOR: KIFERM ®

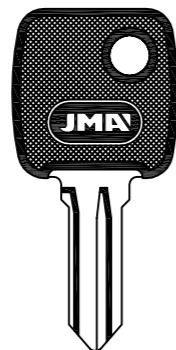

J...
001-224
PJ-2.P

FOR: PJ ®
FOR: KIFERM ®

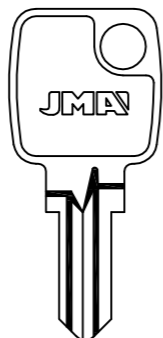

K...4-6-8
K...4-6-8-A-B-C
PJ-K

FOR: PJ ®

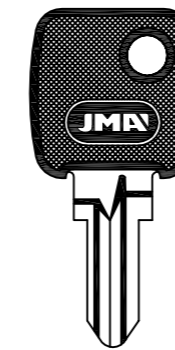

K...4-6-8
K...4-6-8-A-B-C
PJ-K.P

FOR: PJ ®

FOR: CITROEN ®

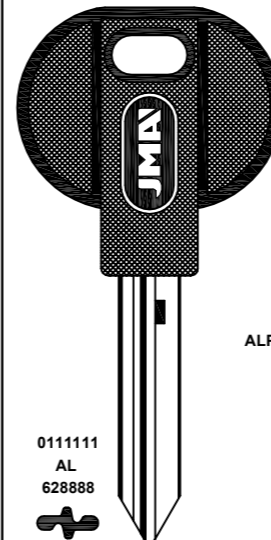

0111111
AL
628888
SIX-5.P

FOR: SIMPLEX ®

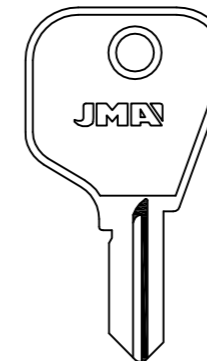

E...
001-649
VA-6

FOR: VACHETTE ®
FOR: SIMPLEX ®

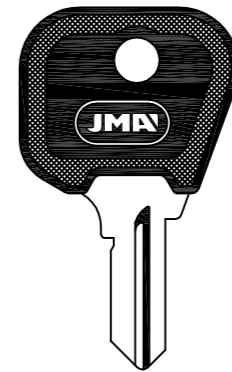

E...
001-649
VA-6.P

FOR: VACHETTE ®
FOR: SIMPLEX ®

FOR: DACIA ®



DAC-1D.P
FOR: DACIA ®

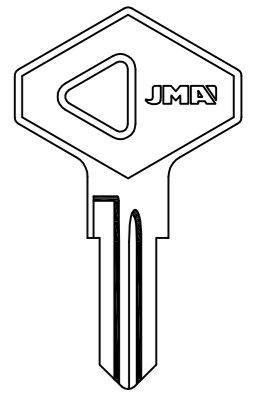

DAC-2D
FOR: DACIA ®

Concerning the marks and commercial denominations see legal warning.
Concerniente a las marcas y denominaciones comerciales ver aviso legal.
Marka eta izendapen komertzialiei dagokienez, ikus lege-oharra.
Concernant les marques et denominations commerciales voir la note dans l'index.

FOR: DACIA®

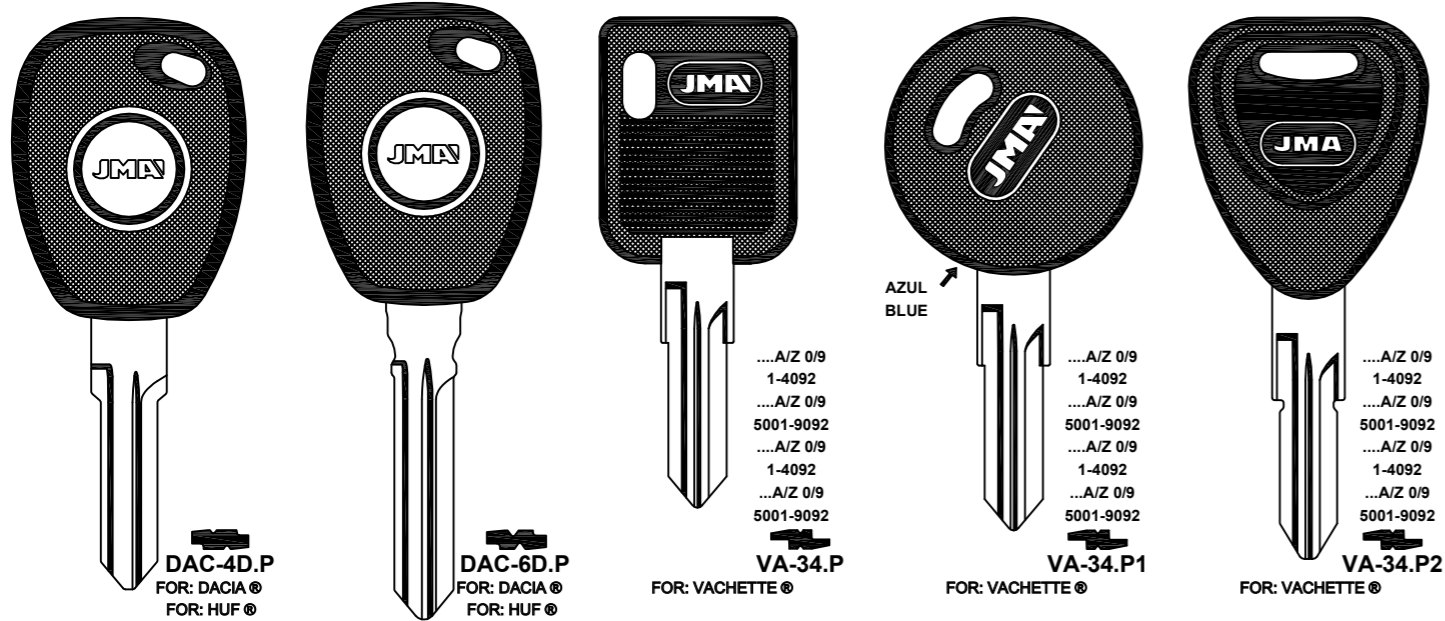

FOR: DAEWOO®

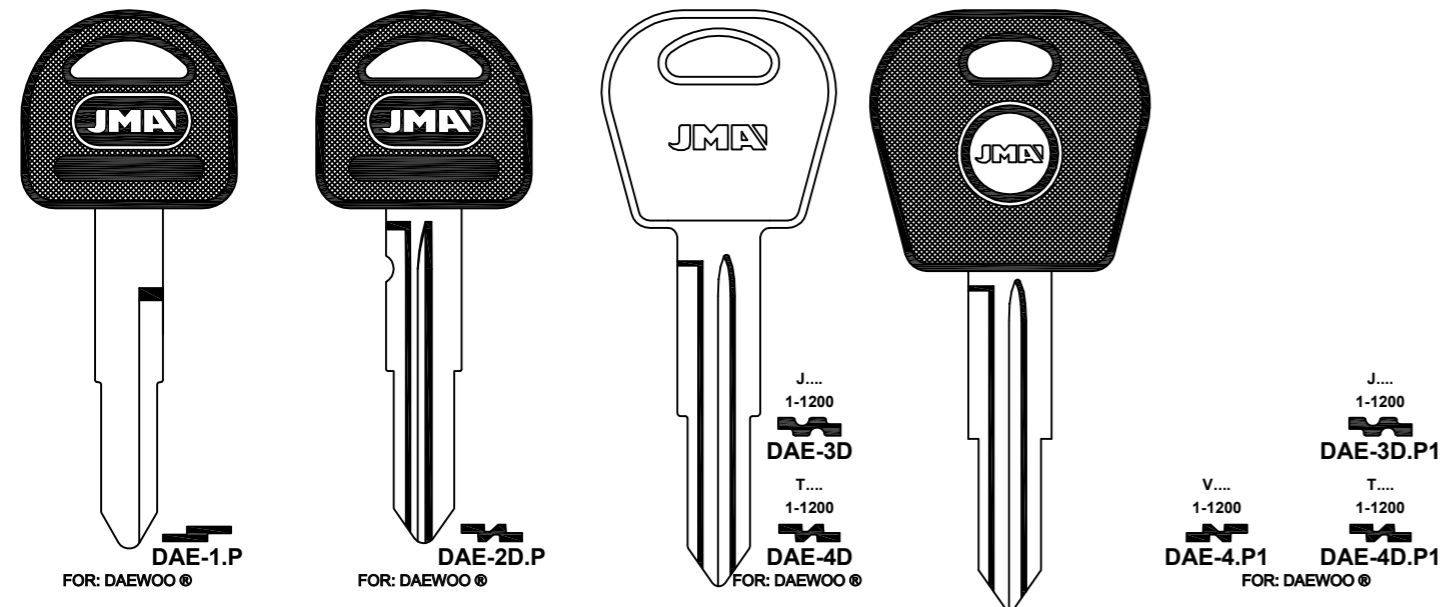

FOR: DAEWOO®

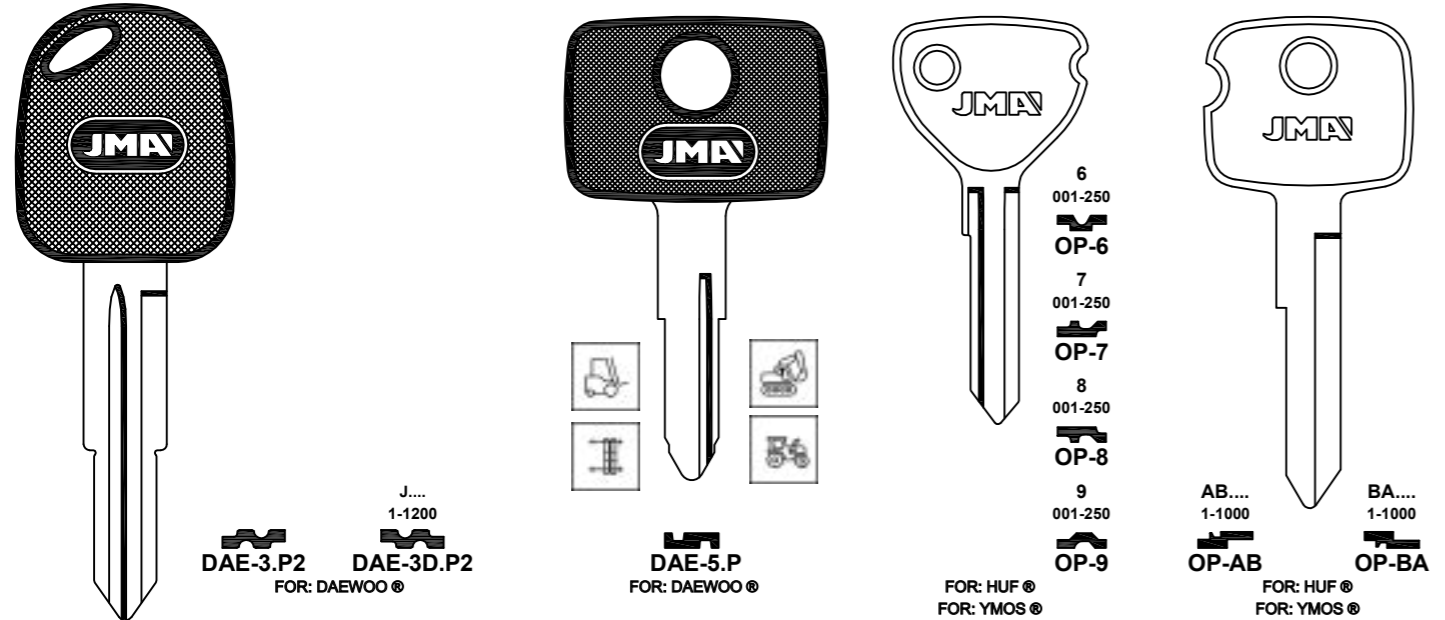

FOR: DAEWOO®

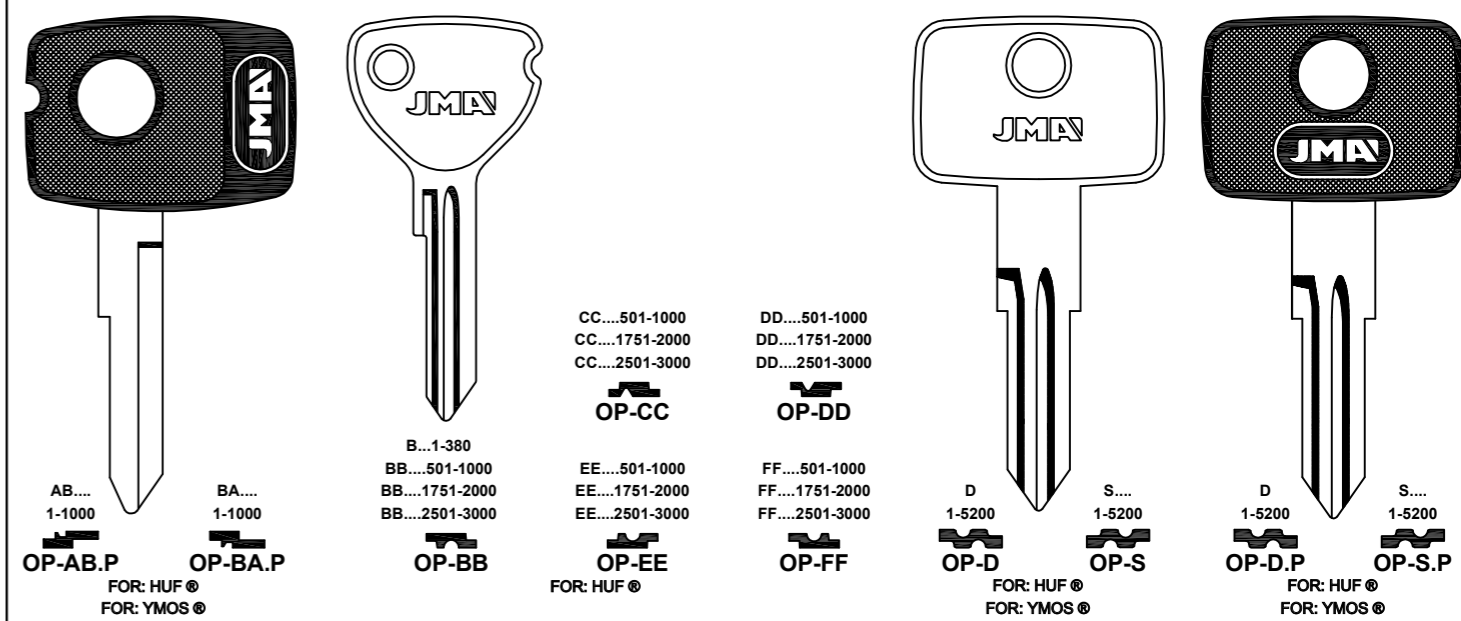

FOR: DAEWOO®

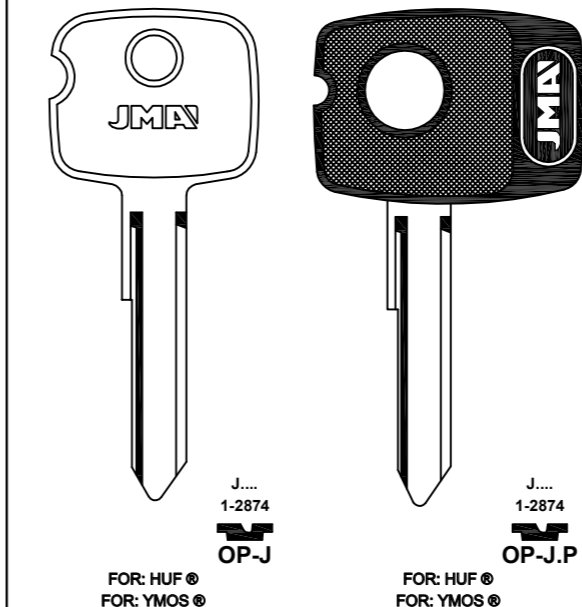

FOR: DAEWOO (USA)®

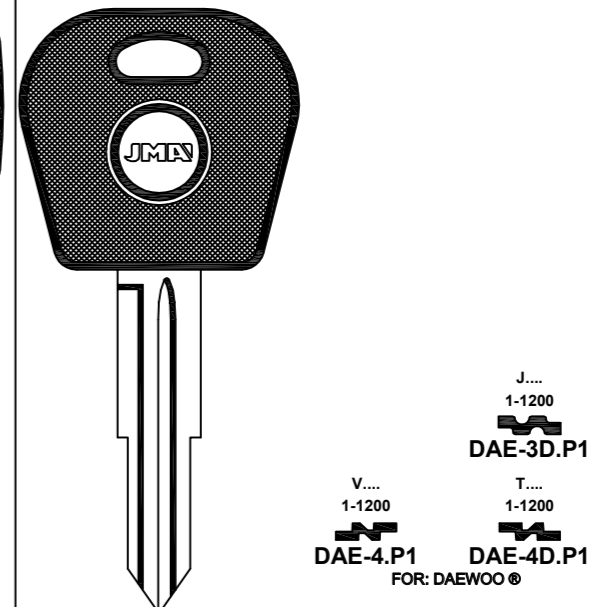

FOR: DAF®

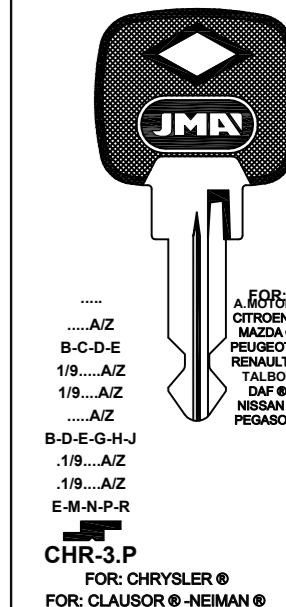

FOR: DAF®

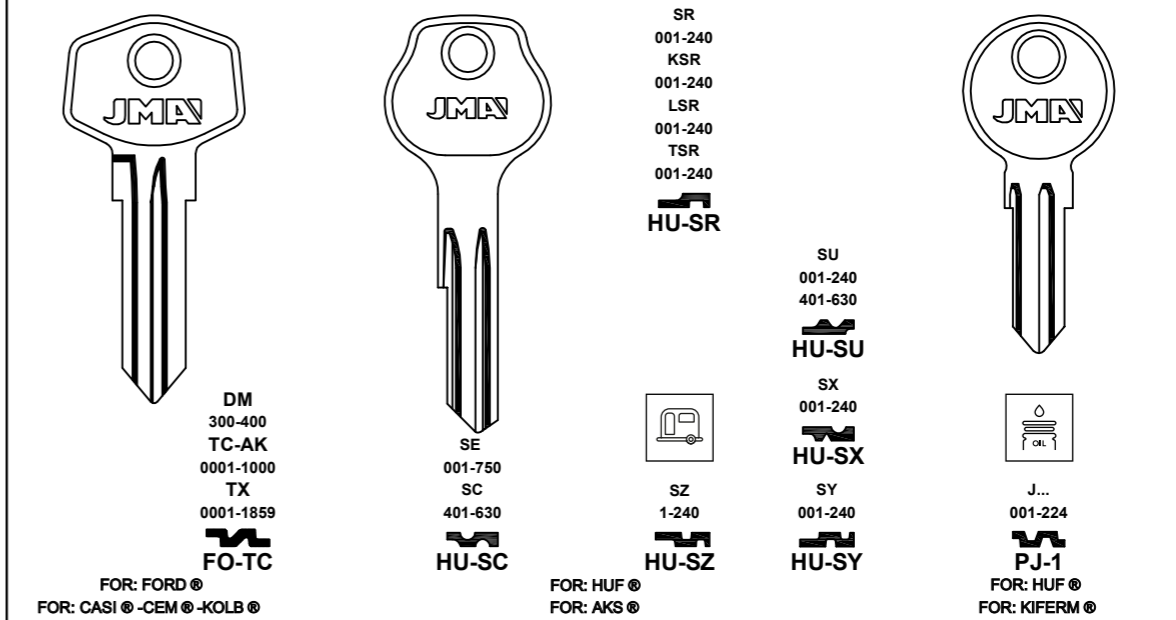

FOR: DAIHATSU®

Concerning the marks and commercial denominations see legal warning.
 Concerniente a las marcas y denominaciones comerciales ver aviso legal.
 Marka eta izendapen komertzialiei dagokienez, ikus lege-oharra.
 Concernant les marques et denominations commerciales voir la note dans l'index.

JMA Opening the future

JMA Opening the future

Beziehen auf die marke und handelsname sehen sie die notiz im Impressum.
 Relativamente às marcas e denominações comerciais, ver aviso legal.
 Jeśli chodzi o znaki i nazwy handlowe, patrz Informacje prawne.

FOR: DAIHATSU®

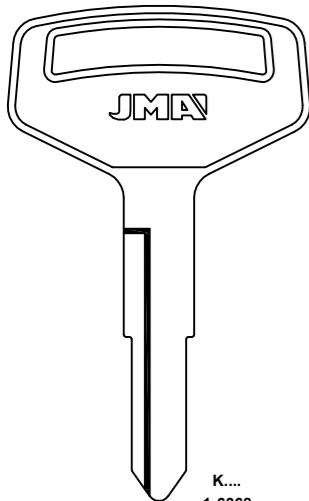

K....
1-6368
DAI-2D
FOR: DAIHATSU®

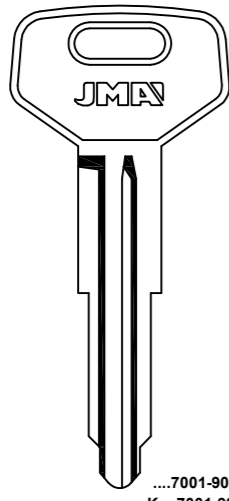

....7001-9000
K....7001-9000
TOYO-3
FOR: TOYOTA®
FOR: TOKAJ®-RIKA®

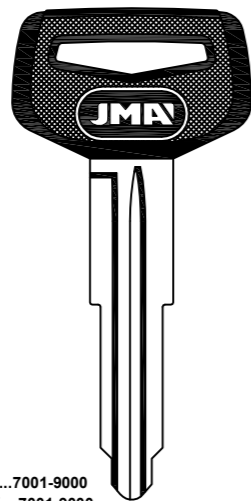

....7001-9000
K....7001-9000
TOYO-3.P
FOR: TOYOTA®
FOR: TOKAJ®-RIKA®

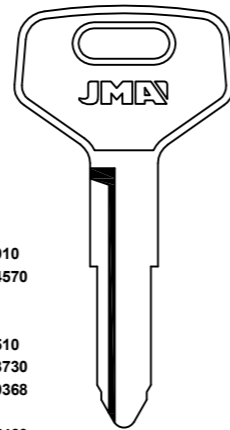

K....
001-400/1511-1910
2221-2620/3731-4570
5001-6368
R....
401-800/1112-1510
2621-3020/3331-3730
5001-6924/8001-9368
S....
5951-6350/7061-7460
8171-8570/9281-9680
D....
6001-7042
TOYO-K1

FOR: TOYOTA®
FOR: TOKAJ®-RIKA®

F....
5951-6350
7061-7460
8171-8570
9281-9680
P....
7001-8500
TOYO-4
C....
6001-7042
TOYO-14

FOR: DE LOREAN®

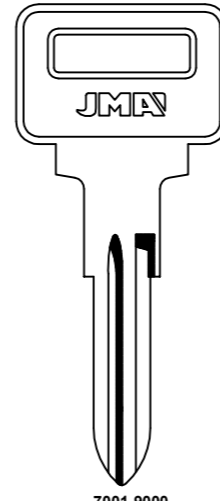

....7001-9000
NE-10
FOR: NEIMAN®

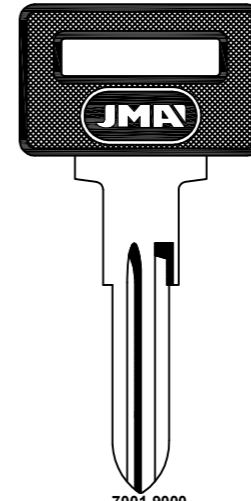

....7001-9000
NE-10.P
FOR: NEIMAN®

FOR: DELTA MOTOR®

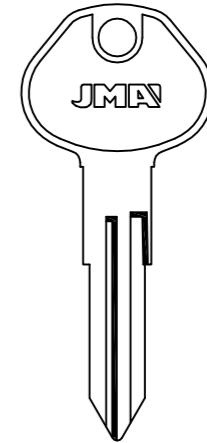

X
0001-8000
DAT-6

DAT-6D

Y
0001-8000
8001-9000
DAT-7

FOR: NISSAN®
FOR: DATSUN®

FOR: DAIHATSU®

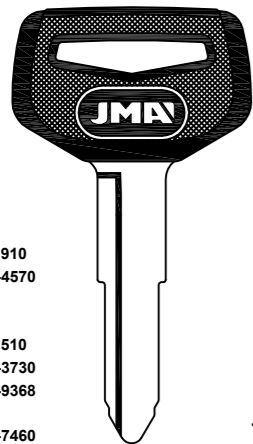

K....
001-400/1511-1910
2221-2620/3731-4570
5001-6368
R....
401-800/1112-1510
2621-3020/3331-3730
5001-6924/8001-9368
S....
5951-6350/7061-7460
8171-8570/9281-9680
D....
6001-7042
TOYO-K1.P

FOR: TOYOTA®
FOR: TOKAJ®-RIKA®

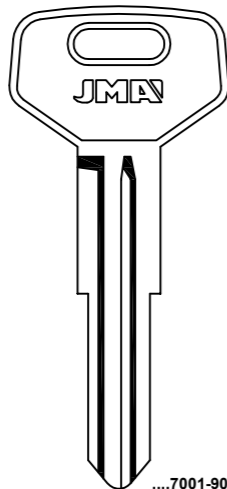

....7001-9000
K....7001-9000
TOYO-8

FOR: TOYOTA®
FOR: TOKAJ®-RIKA®

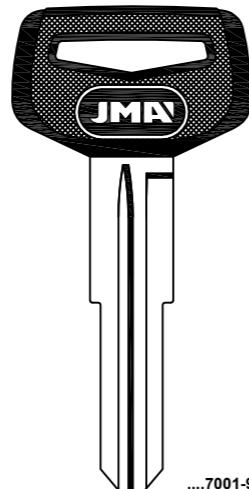

....7001-9000
K....7001-9000
TOYO-8I.P
TOYO-8.P

FOR: TOYOTA®
FOR: TOKAJ®-RIKA®

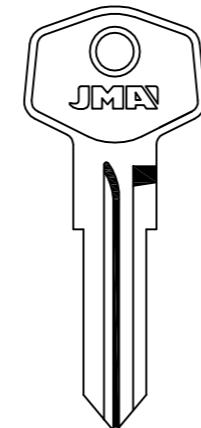

JC
001-852
CEM-JC
AK
0001-1000
FO-5
FOR: CEM®

FOR: DAIMLER®

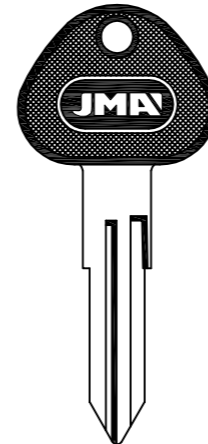

X
0001-8000
DAT-6.P

DAT-6D.P

Y
0001-8000
8001-9000
DAT-7.P

FOR: NISSAN®
FOR: DATSUN®

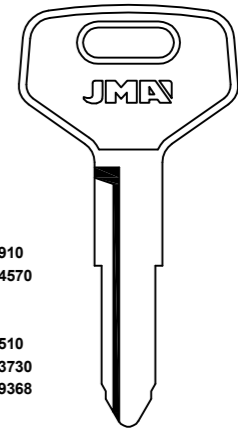

K....
001-400/1511-1910
2221-2620/3731-4570
5001-6368
R....
401-800/1112-1510
2621-3020/3331-3730
5001-6924/8001-9368
S....
5951-6350/7061-7460
8171-8570/9281-9680
D....
6001-7042
TOYO-K1

FOR: TOYOTA®
FOR: TOKAJ®-RIKA®

F....
5951-6350
7061-7460
8171-8570
9281-9680
P....
7001-8500
TOYO-4
C....
6001-7042
TOYO-14

FOR: DELTA MOTOR®

FOR: DAIMLER®

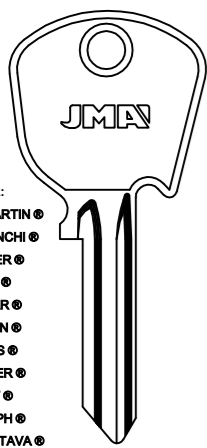

FOR:
ASTON MARTIN®
AUTOBIANCHI®
DAIMLER®
FIAT®
JAGUAR®
JENSEN®
LOTUS®
PREMIER®
SEAT®
TRIUMPH®
YUGO ZASTAVA®
SCANIA®
FK
1-3040
4001-6000
FO-FK
FO-FR

FOR: FORD®
FOR: ARMAN®-DOM®-JUGODENT®-WASO®

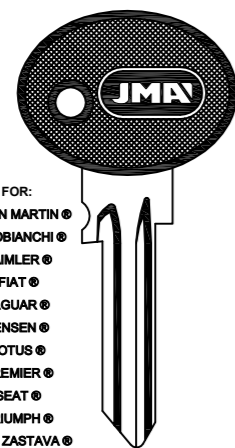

FOR:
ASTON MARTIN®
AUTOBIANCHI®
DAIMLER®
FIAT®
JAGUAR®
JENSEN®
LOTUS®
PREMIER®
SEAT®
TRIUMPH®
YUGO ZASTAVA®
SCANIA®
FK
1-3040
4001-6000
FO-FK.P
FO-FR.P

FOR: FORD®

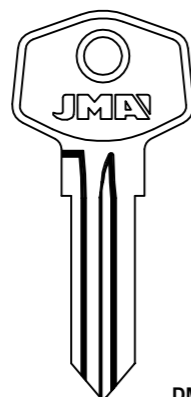

DM
300-400
TC-AK
0001-1000
TX
0001-1859
FO-TC

FOR: FORD®

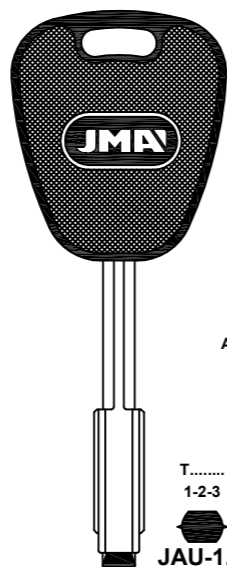

ALP.

T.....
1-2-3
JAU-1.P

FOR: TIBBE®

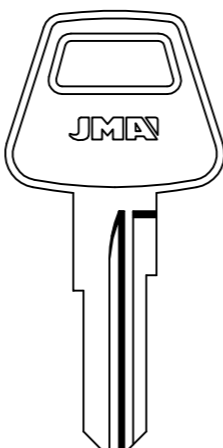

WR
3000-3999
5000-5999
LF-WR

FOR: L & F.®
FOR: WILMOT BREEDEN®

FOR: DE LOREAN®

FOR: DELTA MOTOR®

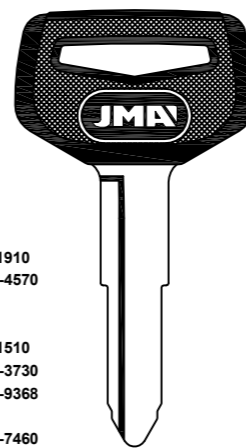

K....
001-400/1511-1910
2221-2620/3731-4570
5001-6368
R....
401-800/1112-1510
2621-3020/3331-3730
5001-6924/8001-9368
S....
5951-6350/7061-7460
8171-8570/9281-9680
D....
6001-7042
TOYO-K1.P

FOR: TOYOTA®
FOR: TOKAJ®-RIKA®

F....
5951-6350
7061-7460
8171-8570
9281-9680
P....
7001-8500
TOYO-4.P
C....
6001-7042
TOYO-14.P

FOR: TOYOTA®
FOR: TOKAJ®-RIKA®

FOR: DISALCAR®

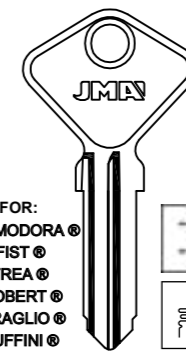

FOR:
CROMODORA®
FIST®
FREA®
GIOBERT®
MIRAGLIO®
RUFFINI®

6
100-309
AF-5I
2
100-309
AF-6I

FOR: SAFE®

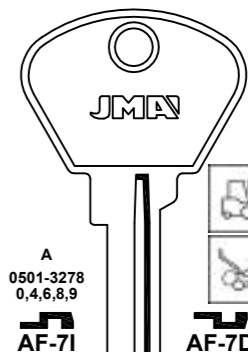

A
0501-3278
0,4,6,8,9
AF-7I

H
01-78
AF-8I
F
01-78
AF-9I

FOR: SIPEA®
FOR: SAFE®

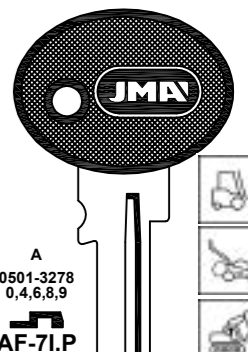

A
0501-3278
0,4,6,8,9
AF-7I.P

H
01-78
AF-8I.P
F
01-78
AF-9I.P

FOR: SIPEA®
FOR: SAFE®

G
01-78
AF-8D.P
E
01-78
AF-9D.P

Concerning the marks and commercial denominations see legal warning.
Concieniente a las marcas y denominaciones comerciales ver aviso legal.
Marka eta izendapen komertzialiei dagokienez, ikus lege-oharra.
Concernant les marques et denominations commerciales voir la note dans l'index.

JMA Opening the future

JMA Opening the future

Beziehen auf die marke und handelsname sehen sie die notiz im Impressum.
Relativamente às marcas e denominações comerciais, ver aviso legal.
Jeśli chodzi o znaki i nazwy handlowe, patrz Informacje prawne.

FOR: DISALCAR®

0501-1000
IMS-3

0501-1000
AF-21

0501-1000
IMS-3.P

0501-1000
AF-21.P

0501-1000
IMS-5

0501-1000
AF-19

0501-1000
IMS-5.P

0501-1000
AF-19.P

7.1
1.95
BH-4

FOR: BOSCH®
FOR: KOLB® -POLAR®

FOR: SAFE®
FOR: CROMODORA® -FIST® -JMSA®

FOR: SAFE®
FOR: CROMODORA® -FIST® -JMSA®

FOR: DODGE®

CJ
001-500
DP
0001-1400
EP
0001-3000

DP
0001-1400
EP
0001-3000

CHR-7
FOR: CHRYSLER®
FOR: YALE®

CHR-8

CJ
001-500
DP
0001-1400
EP
0001-3000

DP
0001-1400
EP
0001-3000

CHR-7.P
FOR: CHRYSLER®
FOR: YALE®

CHR-8.P

FOR: DODGE®

30010-32009
MIT-8D
FOR: MITSUBISHI®

30010-32009
MIT-8D.P
FOR: MITSUBISHI®

E
5001-7679
MIT-12
FOR: MITSUBISHI®

30010-32009
MIT-13D
FOR: MITSUBISHI®

30010-32009
MIT-14D
FOR: MITSUBISHI®

FOR: DODGE®

F... G....
0000-1394
CHR-9
FOR: CHRYSLER®
FOR: YALE®

F... G....
0000-1394
CHR-9.P
FOR: CHRYSLER®
FOR: YALE®

J....
0001-3580
CHR-10
FOR: CHRYSLER®
FOR: YALE®

J....
0001-3580
CHR-10.P
FOR: CHRYSLER®
FOR: YALE®

DS....
0001-1400
ES....
0001-3000

CV
0001-1500
DS
0001-1500
ES
0001-1500

CHR-12
FOR: CHRYSLER®
FOR: BRIGGS & STRATTON®

CHR-13D

FOR: DODGE®

A/Z....
...A/Z
...A/Z 1/9
2700-4816
VA-10
FOR: VACHETTE®

W...
600-842
WAS-1
FOR: WASO®

FOR: EAGLE®

J....
0001-3580
CHR-10
FOR: CHRYSLER®
FOR: YALE®

J....
0001-3580
CHR-10.P
FOR: CHRYSLER®
FOR: YALE®

L.... 1-3580
CHR-14
FOR: CHRYSLER®
FOR: BRIGGS & STRATTON® -YALE®

FOR: DODGE®

L.... 1-3580
CHR-14
FOR: CHRYSLER®
FOR: BRIGGS & STRATTON® -YALE®

L.... 1-3580
CHR-14.P
FOR: CHRYSLER®
FOR: BRIGGS & STRATTON® -YALE®

E....
5001-7679
CHR-17
FOR: CHRYSLER®

E
5001-7000
MIT-7
FOR: MITSUBISHI®
FOR: CHRYSLER® -MITSUBISHI®

E
5001-7000
7001-7679
MIT-15.P
FOR: MITSUBISHI®
FOR: CHRYSLER® -MITSUBISHI®

FOR: EAGLE®

L.... 1-3580
CHR-14.P
FOR: CHRYSLER®
FOR: BRIGGS & STRATTON® -YALE®

E....
5001-7679
CHR-17
FOR: CHRYSLER®

FV-VM
101-225
301-360
VT...
400-474
LF-6
FOR: L. & F.®

H
001-400
2221-2620
4441-4640
4641-5143
E
2001-3000
MIT-11
FOR: MITSUBISHI®

MIT-1D
FOR: MITSUBISHI®

E
5001-7000
MIT-7
FOR: MITSUBISHI®

Concerning the marks and commercial denominations see legal warning.
 Concerniente a las marcas y denominaciones comerciales ver aviso legal.
 Marka eta izendapen komertzialiei dagokienez, ikus lege-oharra.
 Concernant les marques et dénominations commerciales voir la note dans l'index.

FOR: EAGLE®

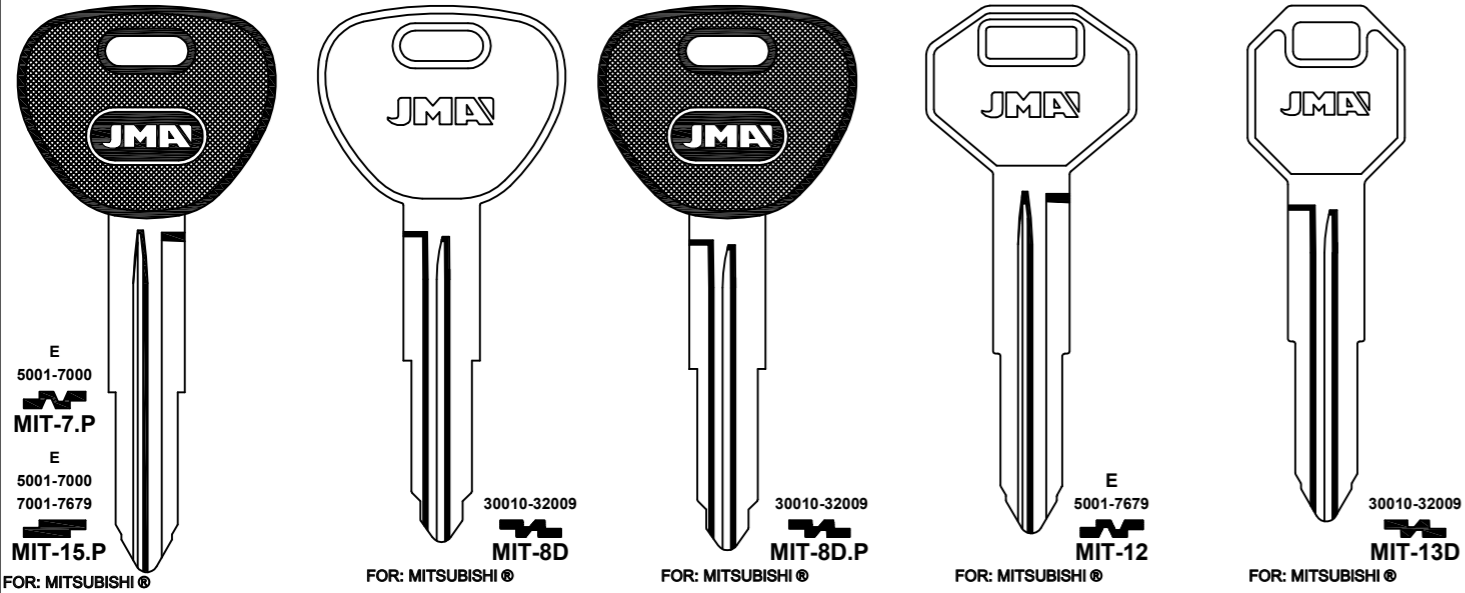

FOR: EAGLE®

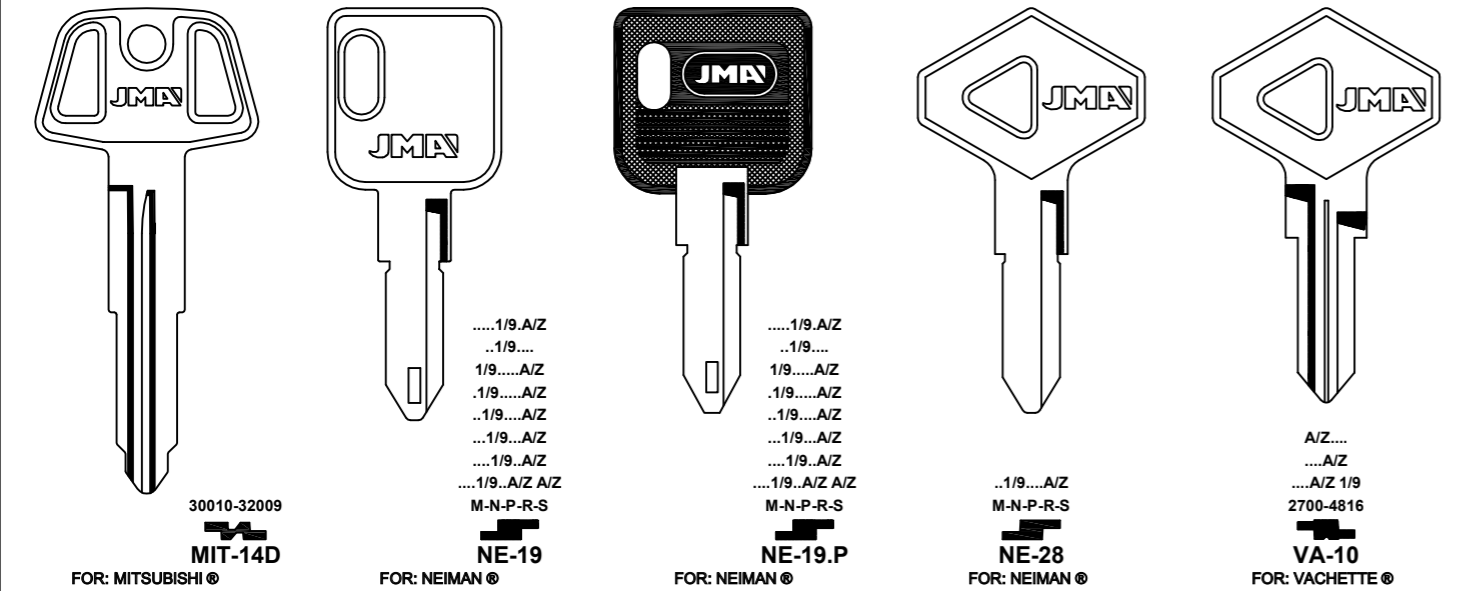

FOR: EBRO®

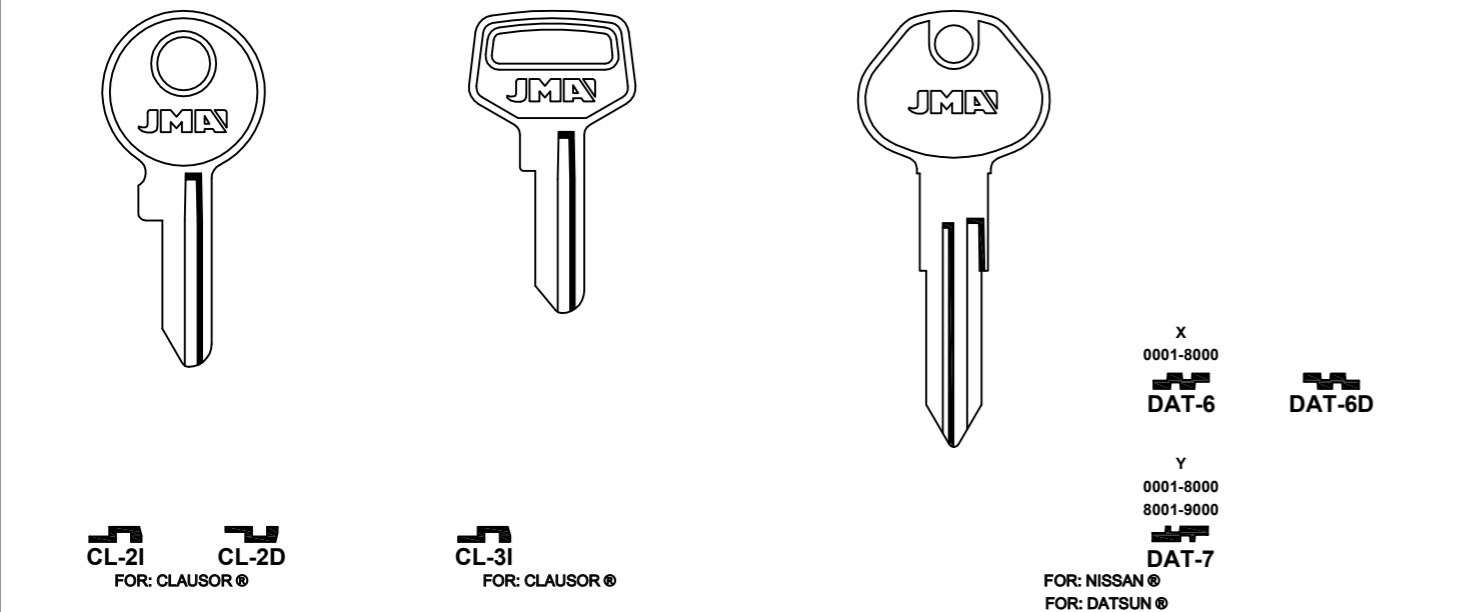

FOR: EBRO®

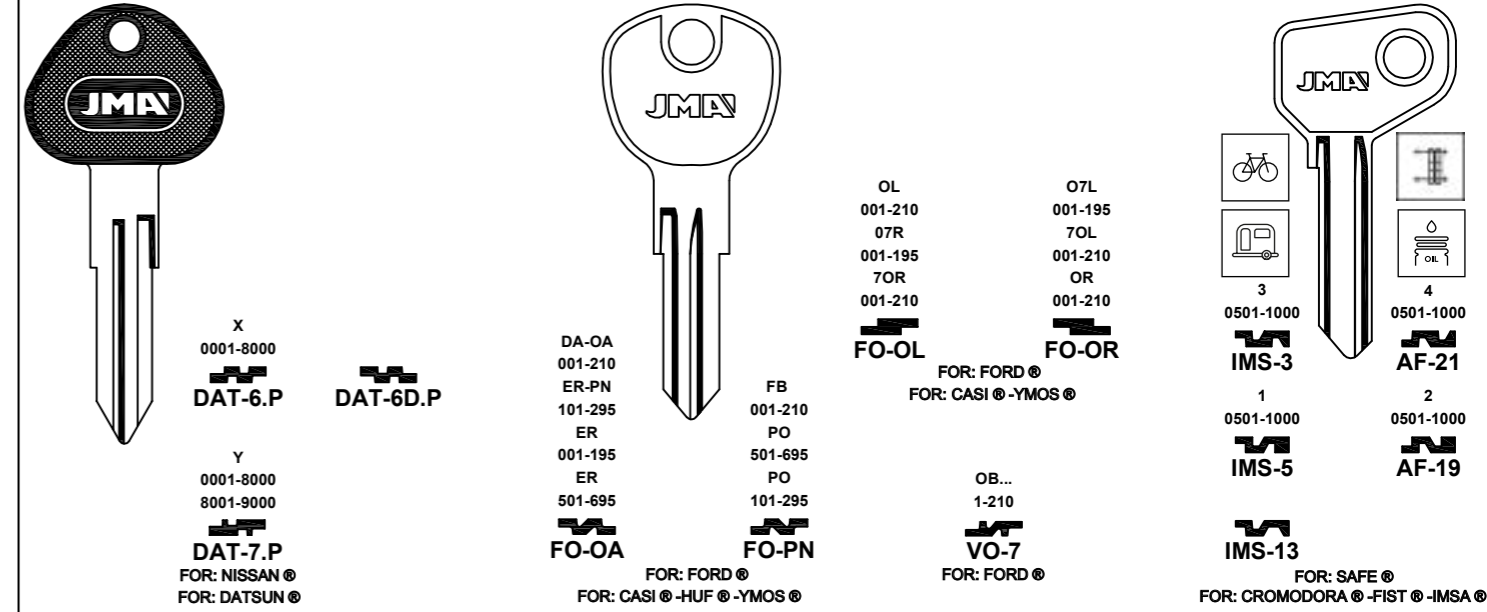

FOR: EBRO®

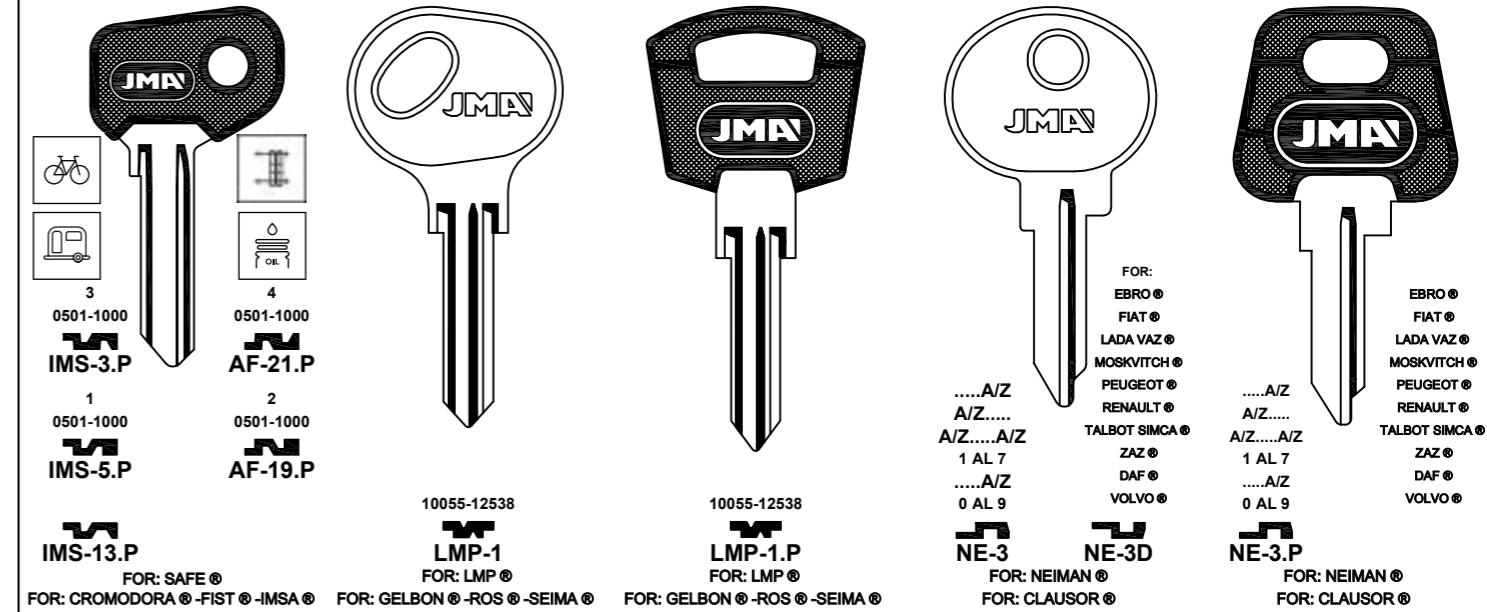

FOR: EBRO®

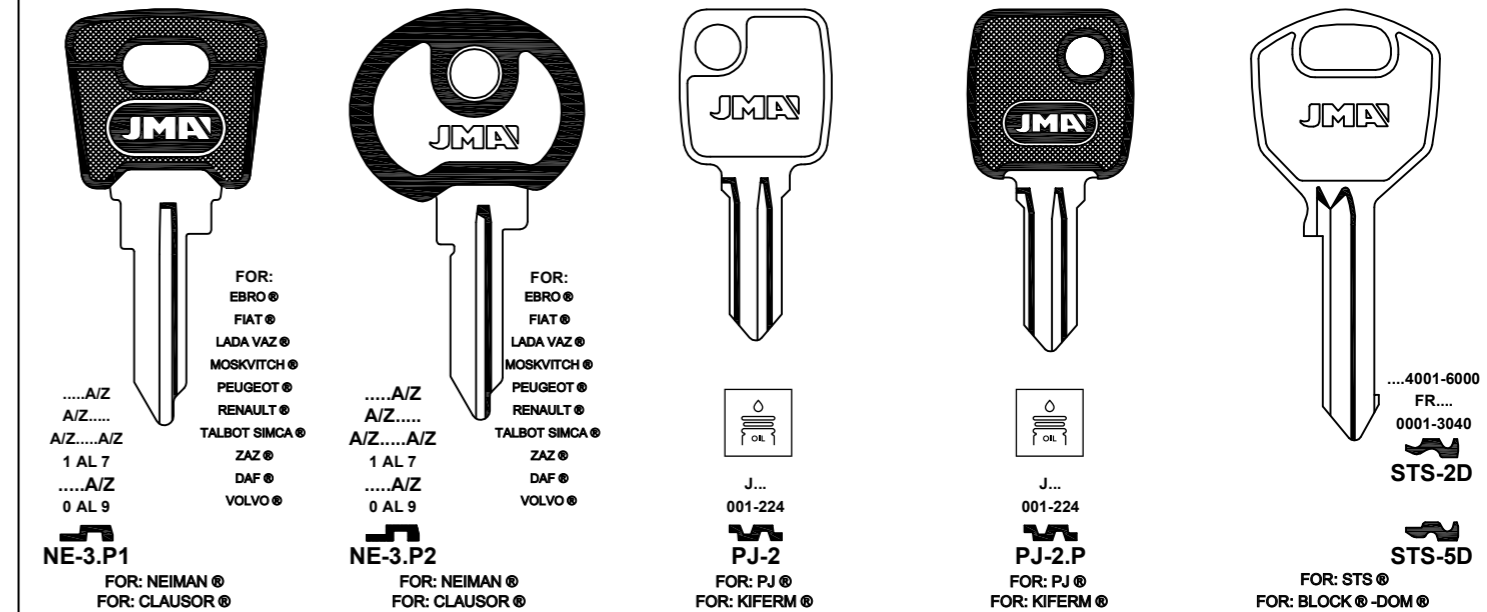

Concerning the marks and commercial denominations see legal warning.
 Concerniente a las marcas y denominaciones comerciales ver aviso legal.
 Marka eta izendapen komertzialiei dagokienez, ikus lege-oharra.
 Concernant les marques et dénominations commerciales voir la note dans l'index.

JMA Opening the future

JMA Opening the future

Beziehen auf die marke und handelsname sehen sie die notiz im Impressum.
 Relativamente às marcas e denominações comerciais, ver aviso legal.
 Jeśli chodzi o znaki i nazwy handlowe, patrz Informacje prawne.

FOR: EBRO®

...4001-6000
FR....
0001-3040
STS-2D.P
FOR: STS®

STS-5D.P
FOR: EBRO®-NISSAN®
FOR: DOM®

FOR: FERRARI®

FOR: CROMODORA®
FIST®
FREA®
GIOBERT®
MIRAGLIO®
RUFFINI®

6 100-309 AF-5I
8 100-309 AF-5D
2 100-309 AF-6I
4 100-309 AF-6D

A 0501-3278 0,4,6,8,9 AF-7I
H 01-78 AF-7D
G 01-78 AF-7I.P
H 01-78 AF-8I
G 01-78 AF-8D
F 01-78 AF-8I.P
E 01-78 AF-8D.P

A 0501-3278 0,4,6,8,9 AF-7I.P
H 01-78 AF-8I
G 01-78 AF-8D.P
F 01-78 AF-9I.P
E 01-78 AF-9D.P

FOR: SAFE®
FOR: SIPEA®
FOR: SIPEA®
FOR: SIPEA®

FOR: FERRARI®

.....A
.....D
.....F
1 AL 5
NE-25
FOR: NEIMAN®

FOR: FIAT®

15-I 15-D
FOR: SAFE®
FOR: TRAMA®-FIST®

A 001-125 AF-1I
B 001-125 AF-1D
FOR: SAFE®
FOR: SIPEA®-MAGNETI MARELLI®

D 1-125 AF-2I
C 1-125 AF-2D
FOR: SAFE®
FOR: SIPEA®-MAGNETI MARELLI®

S 615-699 712-799 812-899 AF-4I
D 115-199 212-299 312-399 AF-4D
FOR: SAFE®
FOR: FIAT®-TRAMA®

FOR: FERRARI®

A 0501-3278 0,4,6,8,9 AF-7I.P1
FOR: SIPEA®
FOR: NEIMAN®

K-H 7001-8092 AF-14.P
FOR: GIOBERT®
FOR: FIST®-M.MARELLI®-NEIMAN®-SIPEA®

H 100-309 FI-6I.P4
FOR: FARMA®
FOR: FISAM®

6 100-517 FAR-1I
8 100-517 FAR-1D
2 100-517 FAR-2I
4 100-517 FAR-2D
H 100-309 FAR-3
FAR-3D
FOR: FARMA®
FOR: FISAM®

K 3301-4886 K 7001-8092 T 5000-6027 T 7001-8092 S 0501-3278 H 7001-8092
FOR: GIOBERT®

K 3301-4886 K 7001-8092 T 5000-6027 T 7001-8092 S 0501-3278 H 7001-8092
FOR: GIOBERT®

FOR: ALFA ROMEO®
AUTOBIANCHI®
CITROEN®
FERRARI®
FIAT®
INNOCENTI®
LANCIA®
PEUGEOT®
YUGO ZASTAVA®
CAGIVA®
DUCATI®
FANTIC MOTOR®
GARELLI®
GILERA®

FOR: FERRARI®
FIAT®
INNOCENTI®
LANCIA®

FOR: FIAT®

FOR: CROMODORA®
FIST®
FREA®
GIOBERT®
MIRAGLIO®
RUFFINI®

6 100-309 AF-5I
8 100-309 AF-5D
2 100-309 AF-6I
4 100-309 AF-6D

A 0501-3278 0,4,6,8,9 AF-7I
H 01-78 AF-7D
G 01-78 AF-7I.P
H 01-78 AF-8I
G 01-78 AF-8D
F 01-78 AF-8I.P
E 01-78 AF-8D.P

A 0501-3278 0,4,6,8,9 AF-7I.P
H 01-78 AF-8I
G 01-78 AF-8D.P
F 01-78 AF-9I.P
E 01-78 AF-9D.P

FOR: SAFE®
FOR: SIPEA®
FOR: SIPEA®
FOR: SIPEA®

A 0501-3278 0,4,6,8,9 AF-7I.P1
FOR: SIPEA®
FOR: NEIMAN®

K-H 7001-8092 AF-14.P
FOR: GIOBERT®
FOR: FIST®-M.MARELLI®-NEIMAN®-SIPEA®

H 100-309 FI-6I.P4
FOR: FARMA®
FOR: FISAM®

6 100-517 FAR-1I
8 100-517 FAR-1D
2 100-517 FAR-2I
4 100-517 FAR-2D
H 100-309 FAR-3
FAR-3D
FOR: FARMA®
FOR: FISAM®

K 3301-4886 K 7001-8092 T 5000-6027 T 7001-8092 S 0501-3278 H 7001-8092
FOR: GIOBERT®

K 3301-4886 K 7001-8092 T 5000-6027 T 7001-8092 S 0501-3278 H 7001-8092
FOR: GIOBERT®

FOR: ALFA ROMEO®
AUTOBIANCHI®
CITROEN®
FERRARI®
FIAT®
INNOCENTI®
LANCIA®
PEUGEOT®
YUGO ZASTAVA®
CAGIVA®
DUCATI®
FANTIC MOTOR®
GARELLI®
GILERA®

FOR: FERRARI®
FIAT®
INNOCENTI®
LANCIA®

FOR: FERRARI®

K 3301-4886 K 7001-8092 T 5000-6027 T 7001-8092 S 0501-3278 H 7001-8092
FOR: GIOBERT®

FERRARI®
CAGIVA®
FI-6I.P2
FOR: GIOBERT®

K 3301-4886 K 7001-8092 T 5000-6027 T 7001-8092 S 0501-3278 H 7001-8092
FOR: GIOBERT®

FOR: AUTOBIANCHI®
CITROEN®
FERRARI®
FIAT®
LANCIA®
PEUGEOT®
YUGO ZASTAVA®
CAGIVA®
DUCATI®
FANTIC MOTOR®
GARELLI®
GILERA®

FOR: HUF®
FOR: NEIMAN®-WITTE®-YMOS®

3 0501-1000 IMS-3
4 0501-1000 AF-21
3 0501-1000 IMS-3.P
4 0501-1000 AF-21.P

1 0501-1000 IMS-5
2 0501-1000 AF-19
1 0501-1000 IMS-5.P
2 0501-1000 AF-19.P

3 0501-1000 IMS-13
4 0501-1000 AF-19
3 0501-1000 IMS-13.P
4 0501-1000 AF-19.P

FOR: SAFE®
FOR: SAFE®
FOR: SAFE®
FOR: SAFE®

FOR: FIAT®

G.Z 7001-9956 CL-7.P
FOR: CLAUSOR®
FOR: GIOBERT®

4... 100-309 FAB-2
FOR: FAAB®

F 01-78 FEM-1I
E 01-78 FEM-1D
H 01-78 FEM-2I
G 01-78 FEM-2D
FOR: FEMSA®

J 3001-6732 N 6001-7000 FI-1
FOR: GIOBERT®

J 3001-6732 N 6001-7000 FI-10
FOR: GIOBERT®

Concerning the marks and commercial denominations see legal warning.
Concerniente a las marcas y denominaciones comerciales ver aviso legal.
Marka eta izendapen komertzialiei dagokienez, ikus lege-oharra.
Concernant les marques et dénominations commerciales voir la note dans l'index.

JMA Opening the future



JMA Opening the future

Beziehen auf die Marke und Handelsname sehen sie die Notiz im Impressum.
Relativamente às marcas e denominações comerciais, ver aviso legal.
Jeśli chodzi o znaki i nazwy handlowe, patrz Informacje prawne.

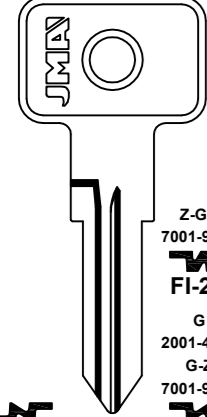
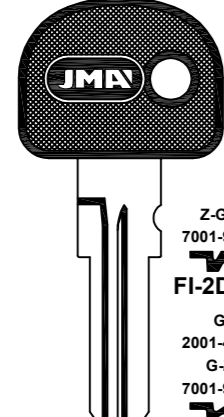
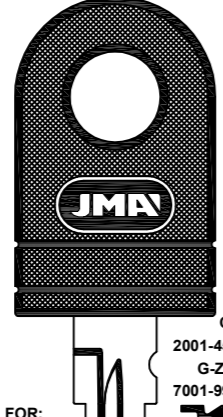
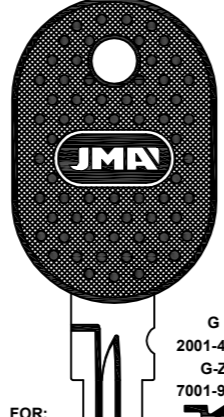
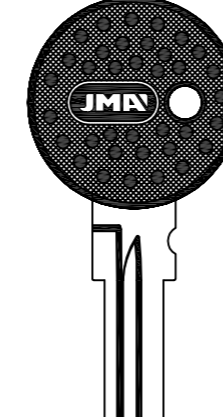

FOR: FIAT®

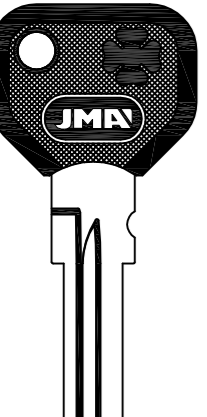
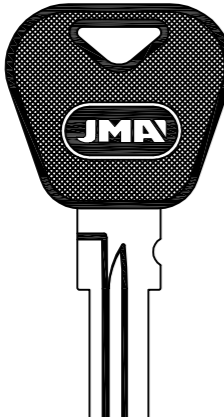
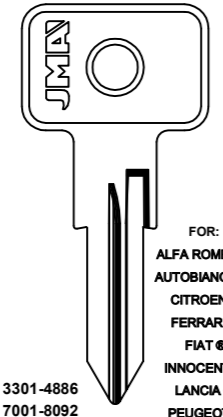
 Z-GR 7001-9956 FI-2D G 2001-4530 G-Z 7001-9956 FI-3D G 7001-9956 FI-12 FOR: GIOBERT®	 Z-GR 7001-9956 FI-2D.P3 G 2001-4530 G-Z 7001-9956 FI-3D.P3 G 7001-9956 FI-12.P3 FOR: GIOBERT®	 G 2001-4530 G-Z 7001-9956 FI-3D.P G 7001-9956 FI-12.P FOR: GIOBERT® FOR: ALFA ROMEO® CITROEN® FIAT® INNOCENTI® LANCIA® SEAT® YUGO ZASTAVA®	 G 2001-4530 G-Z 7001-9956 FI-3D.P1 G 7001-9956 FI-12.P1 FOR: GIOBERT® FOR: ALFA ROMEO® FIAT IVECO®	 G 2001-4530 G-Z 7001-9956 FI-3D.P2 FOR: GIOBERT®
---	---	--	--	--

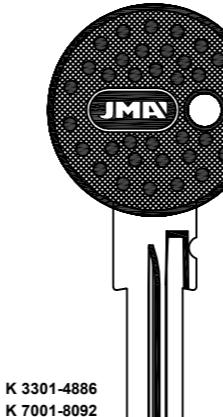

FOR: FIAT®

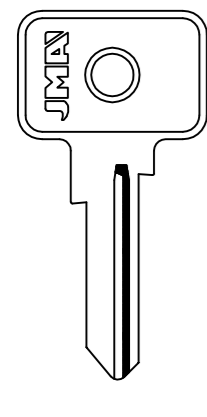
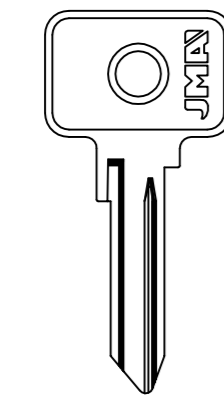
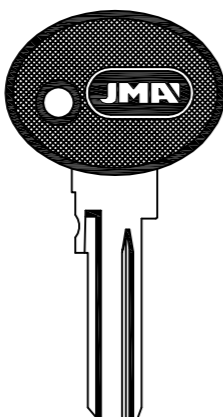
 G 2001-4530 G-Z 7001-9956 FI-3D.P4 FOR: GIOBERT®	 G 2001-4530 G-Z 7001-9956 FI-3D.P5 FOR: GIOBERT®	 FOR: ALFA ROMEO® AUTOBIANCHI® CITROEN® FERRARI® FIAT® INNOCENTI® LANCIA® PEUGEOT® YUGO ZASTAVA® K 3301-4886 K 7001-8092 T 5000-6027 T 7001-8092 S 0501-3278 H 7001-8092 FI-6I FOR: GIOBERT®	 K 3301-4886 K 7001-8092 T 5000-6027 T 7001-8092 S 0501-3278 H 7001-8092 FI-6I.P FOR: GIOBERT® FOR: FERRARI® FIAT® INNOCENTI® LANCIA®	 K 3301-4886 K 7001-8092 T 5000-6027 T 7001-8092 S 0501-3278 H 7001-8092 FI-6I.P2 FOR: GIOBERT® FOR: FERRARI® FIAT® CAGIVA®
--	---	---	--	--

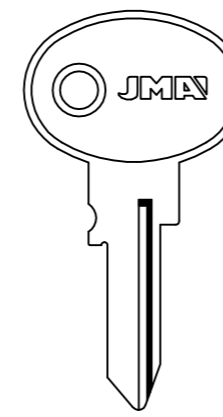
FOR: FIAT®

 X 3301-4886 FI-7I FOR: GIOBERT® FOR: NEIMAN®-SIPA®	 Y 7001-9956 FI-8I FOR: GIOBERT® FOR: ARMAN®	 Y 7001-9956 FI-8I.P FOR: GIOBERT® FOR: ARMAN®	 Y 7001-9956 FI-8I.P1 FOR: GIOBERT® FOR: ARMAN®	 M 0001-1050 FI-9I FOR: GIOBERT®
--	--	--	--	---

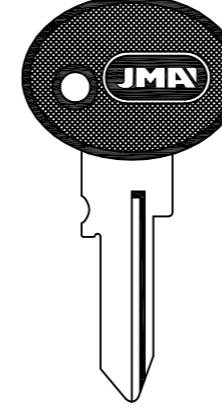
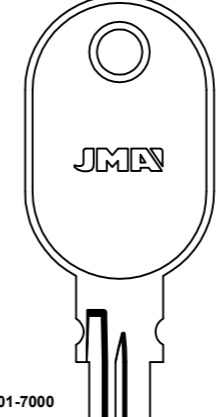
FOR: FIAT®

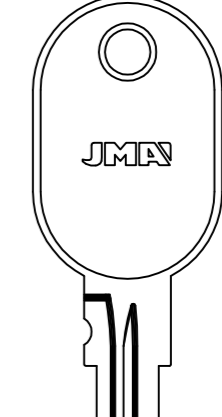
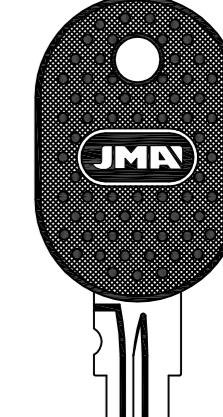

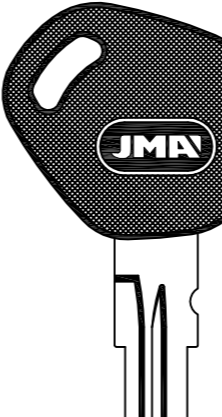
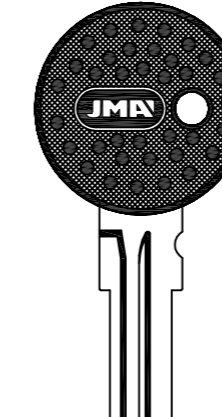
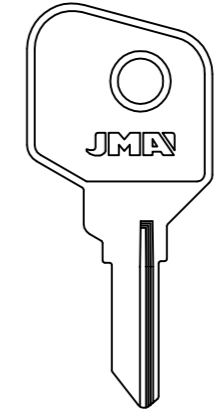
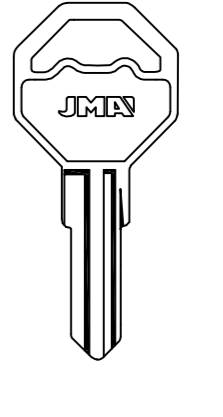
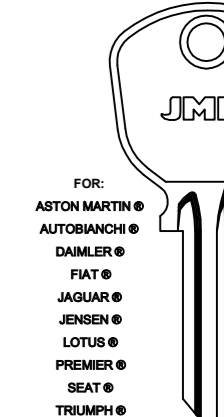
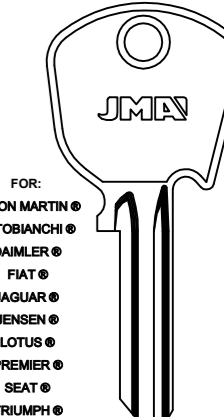

 M 0001-1050 FI-9I.P FOR: GIOBERT®	 N 6001-7000 J 3001-6732 V 0001-3051 V 5001-8058 AB 6001-6891 FI-11 FOR: GIOBERT®	 N 6001-7000 J 3001-6732 V 0001-3051 V 5001-8058 AB 6001-6891 FI-11.P FOR: GIOBERT®	 W 0001-9640 FI-13 FOR: GIOBERT®	 W 0001-9640 FI-13.P FOR: GIOBERT®
---	---	---	---	---

FOR: RAYTON FISSORE®-STEYR PUCH®-APRILIA® FOR: RAYTON FISSORE®-STEYR PUCH®-APRILIA® FOR: ALFA ROMEO®-FIAT®-LANCIA® FOR: ALFA ROMEO®-FIAT®-LANCIA®

FOR: FIAT®

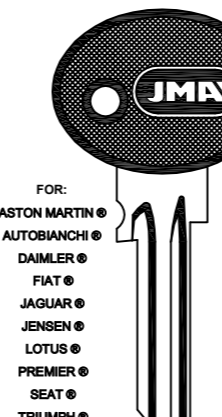
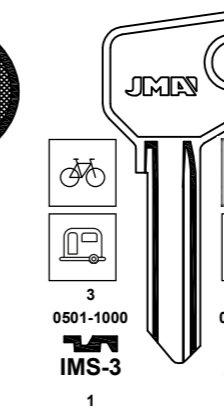
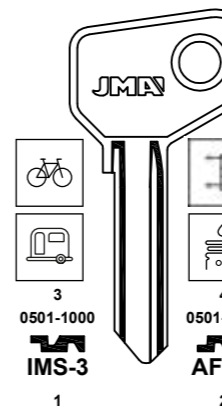
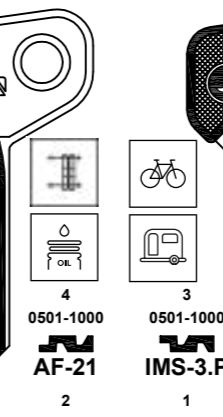
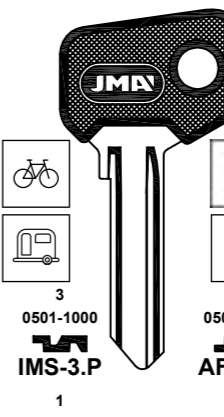
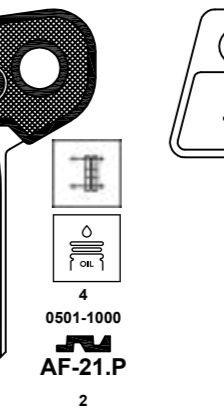
 W 0001-9640 FI-13.P1 FOR: GIOBERT®	 W 0001-9640 FI-14.P FOR: GIOBERT®	 FI-15 FOR: GIOBERT®	 FIA-2 FOR: FIAT®	 FOR: ASTON MARTIN® AUTOBIANCHI® DAIMLER® FIAT® JAGUAR® JENSEN® LOTUS® PREMIER® SEAT® TRIUMPH® YUGO ZASTAVA® SCANIA® FK 1-3040 FO-FK FOR: ARMAN®-DOM®-JUGODENT®-WASO®	 FR 1-3040 4001-6000 FO-FR FOR: FORD®
---	--	--	---	---	--

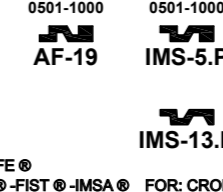
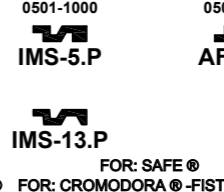
FOR: FIAT®

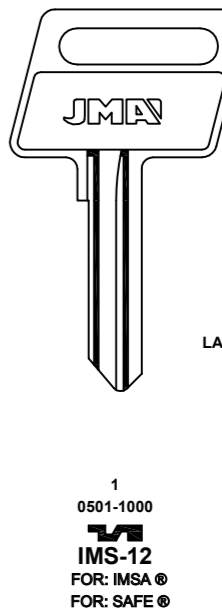
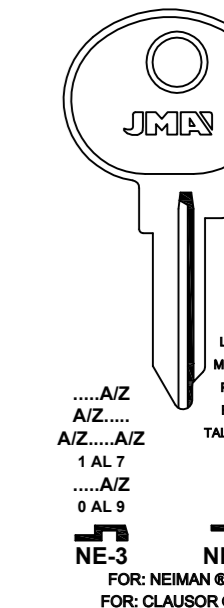
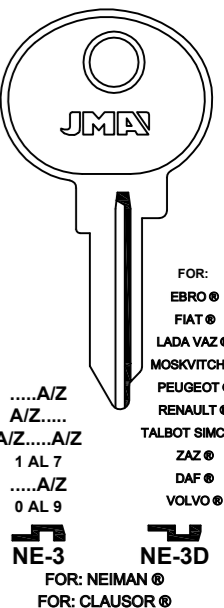
 FOR: ASTON MARTIN® AUTOBIANCHI® DAIMLER® FIAT® JAGUAR® JENSEN® LOTUS® PREMIER® SEAT® TRIUMPH® YUGO ZASTAVA® SCANIA® FK 1-3040 FO-FK.P FOR: ARMAN®-DOM®-JUGODENT®-WASO®	 FR 1-3040 4001-6000 FO-FR.P FOR: FORD®	 3 0501-1000 IMS-3 FOR: SAFE®	 4 0501-1000 AF-21 FOR: SAFE®	 3 0501-1000 IMS-3.P FOR: SAFE®	 4 0501-1000 AF-21.P FOR: SAFE®	 1 0501-1000 IMS-5 FOR: SAFE®	 2 0501-1000 AF-19 FOR: SAFE®	 1 0501-1000 IMS-5.P FOR: SAFE®	 2 0501-1000 AF-19.P FOR: SAFE®	 1 0501-1000 IMS-12 FOR: IMSA® FOR: SAFE®	A/Z A/Z..... A/Z.....A/Z 1 AL 7A/Z 0 AL 9 NE-3 FOR: NEIMAN® FOR: CLAUSSOR®	 FOR: EBRO® FIAT® LADA VAZ® MOSKVITCH® PEUGEOT® RENAULT® TALBOT SIMCA® ZAZ® DAF® VOLVO® FOR: NEIMAN® FOR: CLAUSSOR®
--	---	--	--	--	--	--	--	--	--	---	--	--

Concerning the marks and commercial denominations see legal warning.
 Concerniente a las marcas y denominaciones comerciales ver aviso legal.
 Marka eta izendapen komertzialiei dagokienez, ikus lege-oharra.
 Concernant les marques et dénominations commerciales voir la note dans l'index.

FOR: FIAT®

FOR: EBRO®
FIAT®
LADA VAZ®
MOSKVITCH®
PEUGEOT®
RENAULT®
TALBOT SIMCA®
ZAZ®
DAF®
VOLVO®

FOR: EBRO®
FIAT®
LADA VAZ®
MOSKVITCH®
PEUGEOT®
RENAULT®
TALBOT SIMCA®
ZAZ®
DAF®
VOLVO®

FOR: NEIMAN®
FOR: CLAUROS®

FOR: NEIMAN®
FOR: CLAUROS®

FOR: NEIMAN (RA)®

FOR: SISPA®
FOR: AUTOBLOCK®

FOR: SIPEA®
FOR: MAGNETI MARELLI® -NEIMAN®

FOR: FIAT (ARGETINA)®

FOR: EBRO®
FIAT®
LADA VAZ®
MOSKVITCH®
PEUGEOT®
RENAULT®
TALBOT SIMCA®
ZAZ®
DAF®
VOLVO®

FOR: EBRO®
FIAT®
LADA VAZ®
MOSKVITCH®
PEUGEOT®
RENAULT®
TALBOT SIMCA®
ZAZ®
DAF®
VOLVO®

FOR: EBRO®
FIAT®
LADA VAZ®
MOSKVITCH®
PEUGEOT®
RENAULT®
TALBOT SIMCA®
ZAZ®
DAF®
VOLVO®

FOR: EBRO®
FIAT®
LADA VAZ®
MOSKVITCH®
PEUGEOT®
RENAULT®
TALBOT SIMCA®
ZAZ®
DAF®
VOLVO®

FOR: EBRO®
FIAT®
LADA VAZ®
MOSKVITCH®
PEUGEOT®
RENAULT®
TALBOT SIMCA®
ZAZ®
DAF®
VOLVO®

FOR: FIAT®

FOR: FIAT (ARGETINA)®

FOR: CROMODORA®
FIST®
GIOBERT®
MIRAGLIO®
RUFFINI®

FOR: CROMODORA®
FIST®
GIOBERT®
MIRAGLIO®
RUFFINI®

FOR: CROMODORA®
FIST®
GIOBERT®
MIRAGLIO®
RUFFINI®

FOR: CROMODORA®
FIST®
GIOBERT®
MIRAGLIO®
RUFFINI®

FOR: CROMODORA®
FIST®
GIOBERT®
MIRAGLIO®
RUFFINI®

FOR: FIAT (ARGETINA)®

FOR: ASTON MARTIN®
AUTOBIANCHI®
DAIMLER®
FIAT®
JAGUAR®
JENSEN®
LOTUS®
PREMIER®
SEAT®
TRIUMPH®
YUGO ZASTAVA®

FOR: ASTON MARTIN®
AUTOBIANCHI®
DAIMLER®
FIAT®
JAGUAR®
JENSEN®
LOTUS®
PREMIER®
SEAT®
TRIUMPH®
YUGO ZASTAVA®

FOR: ASTON MARTIN®
AUTOBIANCHI®
DAIMLER®
FIAT®
JAGUAR®
JENSEN®
LOTUS®
PREMIER®
SEAT®
TRIUMPH®
YUGO ZASTAVA®

FOR: ASTON MARTIN®
AUTOBIANCHI®
DAIMLER®
FIAT®
JAGUAR®
JENSEN®
LOTUS®
PREMIER®
SEAT®
TRIUMPH®
YUGO ZASTAVA®

FOR: ASTON MARTIN®
AUTOBIANCHI®
DAIMLER®
FIAT®
JAGUAR®
JENSEN®
LOTUS®
PREMIER®
SEAT®
TRIUMPH®
YUGO ZASTAVA®

FOR: FIAT (ARGETINA)®

FOR: FIAT (ARGETINA)®

FOR: EBRO®
FIAT®
LADA VAZ®
MOSKVITCH®
PEUGEOT®
RENAULT®
TALBOT SIMCA®
ZAZ®
DAF®
VOLVO®

FOR: EBRO®
FIAT®
LADA VAZ®
MOSKVITCH®
PEUGEOT®
RENAULT®
TALBOT SIMCA®
ZAZ®
DAF®
VOLVO®

FOR: EBRO®
FIAT®
LADA VAZ®
MOSKVITCH®
PEUGEOT®
RENAULT®
TALBOT SIMCA®
ZAZ®
DAF®
VOLVO®

FOR: EBRO®
FIAT®
LADA VAZ®
MOSKVITCH®
PEUGEOT®
RENAULT®
TALBOT SIMCA®
ZAZ®
DAF®
VOLVO®

FOR: EBRO®
FIAT®
LADA VAZ®
MOSKVITCH®
PEUGEOT®
RENAULT®
TALBOT SIMCA®
ZAZ®
DAF®
VOLVO®

FOR: EBRO®
FIAT®
LADA VAZ®
MOSKVITCH®
PEUGEOT®
RENAULT®
TALBOT SIMCA®
ZAZ®
DAF®
VOLVO®

FOR: EBRO®
FIAT®
LADA VAZ®
MOSKVITCH®
PEUGEOT®
RENAULT®
TALBOT SIMCA®
ZAZ®
DAF®
VOLVO®

FOR: EBRO®
FIAT®
LADA VAZ®
MOSKVITCH®
PEUGEOT®
RENAULT®
TALBOT SIMCA®
ZAZ®
DAF®
VOLVO®

FOR: EBRO®
FIAT®
LADA VAZ®
MOSKVITCH®
PEUGEOT®
RENAULT®
TALBOT SIMCA®
ZAZ®
DAF®
VOLVO®

FOR: EBRO®
FIAT®
LADA VAZ®
MOSKVITCH®
PEUGEOT®
RENAULT®
TALBOT SIMCA®
ZAZ®
DAF®
VOLVO®

Concerning the marks and commercial denominations see legal warning.
Concerniente a las marcas y denominaciones comerciales ver aviso legal.
Marka eta izendapen komertzialiei dagokienez, ikus lege-oharra.
Concernant les marques et denominations commerciales voir la note dans l'index.

JMA Opening the future

JMA Opening the future

Beziehen auf die marke und handelsname sehen sie die notiz im Impressum.
Relativamente às marcas e denominações comerciais, ver aviso legal.
Jeśli chodzi o znaki i nazwy handlowe, patrz Informacje prawne.

FOR: FIAT (ARGENTINA)®

.A/Z....
.A/Z...A/Z
A/Z...A/Z
0 AL 8
1 AL 7
A/Z...1 AL 7 Y A A L E
NE-4.P

11-34-39...
1 AL 7
34-39...A/Z
1 AL 7
NE-15I.P FOR: NEIMAN®
NE-15D.P FOR: NEIMAN (RA)®

NE-46 FOR: NEIMAN (RA)®

NE-53 FOR: NEIMAN (RA)®

SI-3 FOR: SISPA®
SI-2D FOR: AUTOBLOCK®

FOR: FIAT (TURQUIA)®

A 0501-3278 0,4,6,8,9
AF-7I FOR: SIPEA®
AF-7D FOR: SAFE®

A 0501-3278 0,4,6,8,9
AF-7I.P FOR: SIPEA®
AF-7D FOR: SAFE®

F 01-78
FEM-1I FOR: FEMSA®
FEM-1D FOR: FEMSA®

E 01-78
FEM-2I FOR: FEMSA®
FEM-2D FOR: FEMSA®

FI-3 FOR: GIOBERT®

Z-GR 7001-9956
FI-2D FOR: GIOBERT®
G 2001-4530 G-Z 7001-9956
FI-3D FOR: GIOBERT®
G 7001-9956
FI-12 FOR: GIOBERT®

Z-GR 7001-9956
FI-2D.P3 FOR: GIOBERT®
G 2001-4530 G-Z 7001-9956
FI-3D.P3 FOR: GIOBERT®
G 7001-9956
FI-12.P3 FOR: GIOBERT®

FOR: FIAT (ARG.)®

FOR: FIAT (BRASIL)®

B....501-3278
B....0-4-6-8-9
SIP-3 FOR: SIPEA®
FOR: ARTEB®-CLAUSOR®-NEIMAN®

J 3001-6732 N 6001-7000
FI-1 FOR: GIOBERT®

J 3001-6732 N 6001-7000
FI-10 FOR: GIOBERT®

J 3001-6732 N 6001-7000
FI-1.P FOR: GIOBERT®

N 6001-7000 J 3001-6732 V 0001-3051 V 5001-8058 AB 6001-6891
FI-11 FOR: GIOBERT®

N 6001-7000 J 3001-6732 V 0001-3051 V 5001-8058 AB 6001-6891
FI-11.P FOR: GIOBERT®

FOR: FIAT (TURQUIA)®

G 2001-4530 G-Z 7001-9956
FI-3D.P2 FOR: GIOBERT®

G 2001-4530 G-Z 7001-9956
FI-6I FOR: GIOBERT®

K 3301-4886 K 7001-8092 T 5000-6027 T 7001-8092 S 0501-3278 H 7001-8092
FI-6I.P FOR: GIOBERT®

FOR: ALFA ROMEO®
AUTOBIANCHI®
CITROEN®
FERRARI®
FIAT®
INNOCENTI®
LANCIA®
PEUGEOT®
YUGO ZASTAVA®
CAGIVA®
DUCATI®
FANTIC MOTOR®
GARELLI®
GILERA®

K 3301-4886 K 7001-8092 T 5000-6027 T 7001-8092 S 0501-3278 H 7001-8092
FI-6I.P FOR: GIOBERT®

FOR: FERRARI®
FIAT®
INNOCENTI®
LANCIA®

W 0001-9640
FI-13 FOR: GIOBERT®

W 0001-9640
FI-13.P FOR: GIOBERT®

FOR: FIAT (BRASIL)®

FOR: FIAT (TURQUIA)®

W 0001-9640
FI-13.P7 FOR: GIOBERT®
FOR: SIPEA®

3 0501-1000 IMS-3 FOR: SAFE®
4 0501-1000 AF-21 FOR: CROMODORA®-FIST®-JMSA®

3 0501-1000 IMS-3.P FOR: SAFE®
4 0501-1000 AF-21.P FOR: CROMODORA®-FIST®-JMSA®

1 0501-1000 IMS-5 FOR: SAFE®
2 0501-1000 AF-19 FOR: CROMODORA®-FIST®-JMSA®

1 0501-1000 IMS-5.P FOR: SAFE®
2 0501-1000 AF-19.P FOR: CROMODORA®-FIST®-JMSA®

1 0501-1000 IMS-12 FOR: IMSA®
FOR: SAFE®

SI-3 FOR: SISPA®
SI-3D FOR: AUTOBLOCK®

W 0001-9640
FI-14.P FOR: GIOBERT®

FOR: ASTON MARTIN®
AUTOBIANCHI®
DAIMLER®
FIAT®
JAGUAR®
JENSEN®
LOTUS®
PREMIER®
SEAT®
TRIUMPH®
YUGO ZASTAVA®

FR 1-3040 4001-6000
FO-FK FOR: ARMAN®-DOM®-JUGODENT®-WASO®
FO-FR FOR: ARMAN®-DOM®-JUGODENT®-WASO®

3 0501-1000 IMS-3 FOR: SAFE®
4 0501-1000 AF-21 FOR: CROMODORA®-FIST®-JMSA®

3 0501-1000 IMS-3.P FOR: SAFE®
4 0501-1000 AF-21.P FOR: CROMODORA®-FIST®-JMSA®

1 0501-1000 IMS-5 FOR: SAFE®
2 0501-1000 AF-19 FOR: CROMODORA®-FIST®-JMSA®

1 0501-1000 IMS-5.P FOR: SAFE®
2 0501-1000 AF-19.P FOR: CROMODORA®-FIST®-JMSA®

IMS-13 FOR: SAFE®

IMS-13.P FOR: SAFE®

Concerning the marks and commercial denominations see legal warning.
Concerniente a las marcas y denominaciones comerciales ver aviso legal.
Marka eta izendapen komertzialiei dagokienez, ikus lege-oharra.
Concernant les marques et denominations commerciales voir la note dans l'index.

JMA Opening the future

JMA Opening the future

Beziehen auf die marke und handelsname sehen sie die notiz im Impressum.
Relativamente às marcas e denominações comerciais, ver aviso legal.
Jeśli chodzi o znaki i nazwy handlowe, patrz Informacje prawne.

FOR: FIAT(TURQ.)®

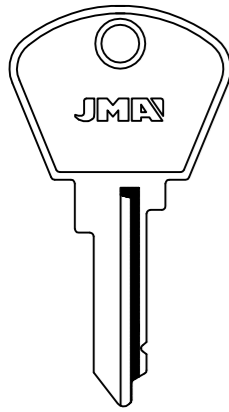

....4-6-8-9



FOR: SIPEA®

FOR: MAGNETI MARELLI® -NEIMAN®

FOR: FIAT IVECO®

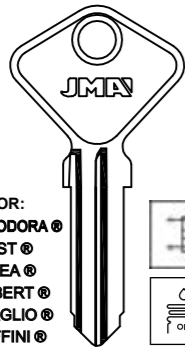

FOR:
CROMODORA®
FIST®
GIOBERT®
MIRAGLIO®
RUFFINI®

6

100-309



AF-5I

2

100-309



AF-6I

FOR: SAFE®

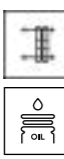

8

100-309



AF-5D

4

100-309



AF-6D

A
0501-3278
0,4,6,8,9



AF-7I

H

O1-78



AF-8I

F

O1-78



AF-9I

FOR: SIPEA®
FOR: SAFE®



G

O1-78



AF-8D

E

O1-78



AF-9D

FOR: SIPEA®
FOR: SAFE®



A
0501-3278
0,4,6,8,9



AF-7I.P

H

O1-78



AF-8I.P

F

O1-78



AF-9I.P

FOR: SIPEA®
FOR: SAFE®

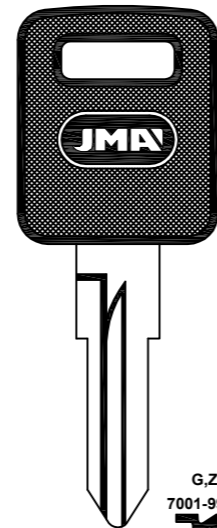

G,Z
7001-9956



CL-7.P

FOR: CLAUSOR®
FOR: GIOBERT®

FOR: FIAT IVECO®



Y
7001-9956



FI-8I.P1

FOR: GIOBERT®
FOR: ARMAN®

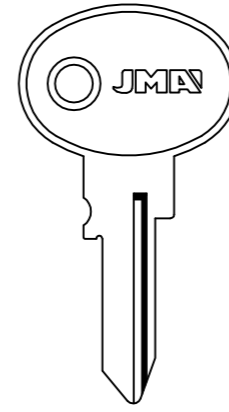

M
0001-1050



FI-9I

FOR: GIOBERT®

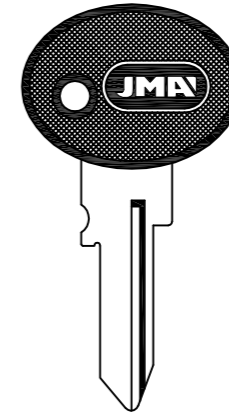

M
0001-1050



FI-9I.P

FOR: GIOBERT®

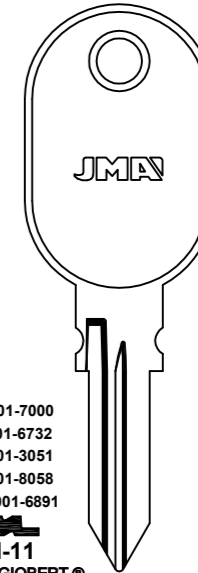

N 6001-7000
J 3001-6732
V 0001-3051
V 5001-8058
AB 6001-6891



FI-11

FOR: GIOBERT®

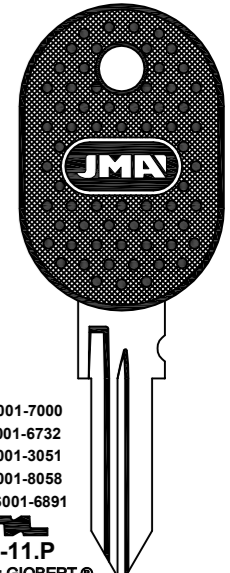

N 6001-7000
J 3001-6732
V 0001-3051
V 5001-8058
AB 6001-6891



FI-11.P

FOR: GIOBERT®

FOR: FIAT IVECO®

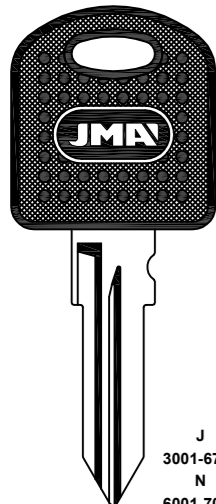

J
3001-6732

N
6001-7000



FI-1.P8

FOR: GIOBERT®

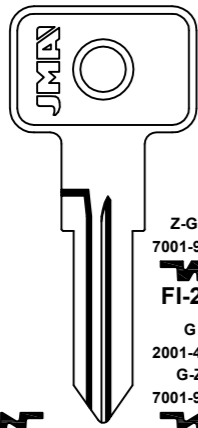

FI-3

FOR: GIOBERT®

Z-GR
7001-9956



FI-2D

G

2001-4530

G-Z

7001-9956



FI-3D

G

7001-9956



FI-12

FOR: GIOBERT®

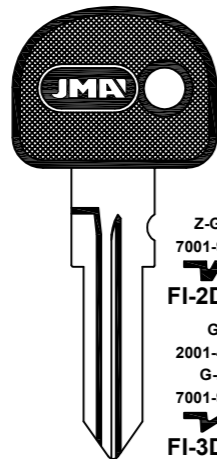

Z-GR
7001-9956



FI-2D.P3

G

2001-4530

G-Z

7001-9956



FI-3D.P3

G

7001-9956



FI-12.P3

FOR: GIOBERT®

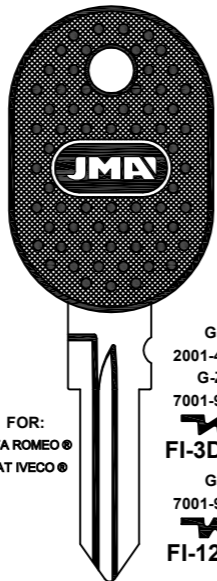

G
2001-4530

G-Z

7001-9956



FI-3D.P1

G

7001-9956



FI-12.P1



FI-6I

FOR:
ALFA ROMEO®
FIAT IVECO®

K 3301-4886
K 7001-8092
T 5000-6027
T 7001-8092
S 0501-3278
H 7001-8092

FOR:
ALFA ROMEO®
AUTOBIANCHI®
CITROEN®
FERRARI®
FIAT®
INNOCENTI®
LANCIA®
PEUGEOT®
YUGO ZASTAVA
CAGIVA®
DUCATI®
FANTIC MOTOR®
GARELLI®
GILERA®

FOR: GIOBERT®

FOR: FIAT IVECO®

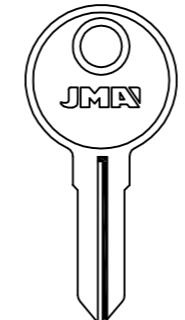

LAT.



FIS-1D

FOR: FIST®

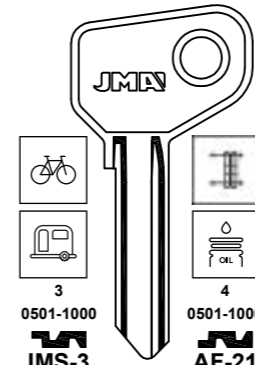

3
0501-1000



IMS-3

1

0501-1000



IMS-5

IMS-13

FOR: CROMODORA® -FIST® -IMSA®

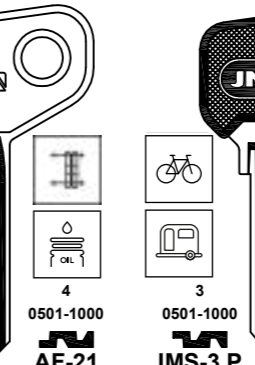

4
0501-1000



AF-21

2

0501-1000



AF-19

IMS-13.P

FOR: SAFE®

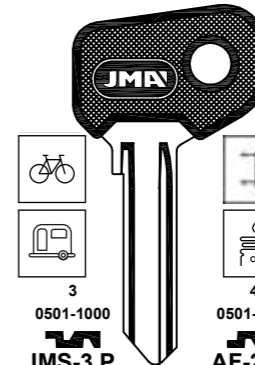

3
0501-1000



IMS-3.P

1

0501-1000



IMS-5.P

IMS-13.P

FOR: SAFE®

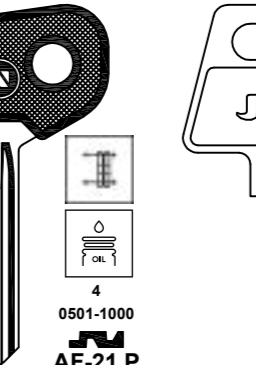

4
0501-1000



AF-21.P

2

0501-1000



AF-19.P

IMS-12

FOR: IMSA®

FOR: SAFE®

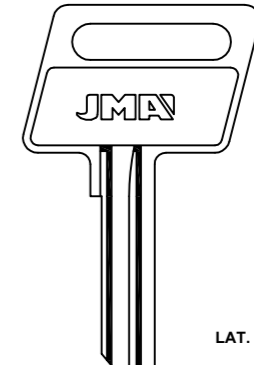

1
0501-1000



IMS-12

FOR: IMSA®

FOR: SAFE®

LAT.

FOR: FORD®

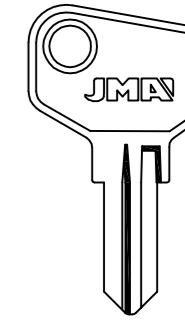

15



AB-6I

FOR: PROAUTO®

14



AB-8I

FOR: ABSA®

13



AB-8D

FOR: ARFE® -FROSER® -KEYA®

FOR: FIAT IVECO®

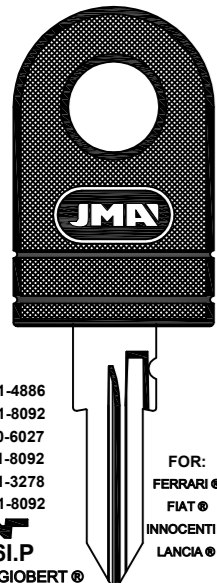

K 3301-4886
K 7001-8092
T 5000-6027
T 7001-8092
S 0501-3278
H 7001-8092

FOR:
FERRARI®
FIAT®
INNOCENTI®
LANCIA®



FI-6I.P

FOR: GIOBERT®

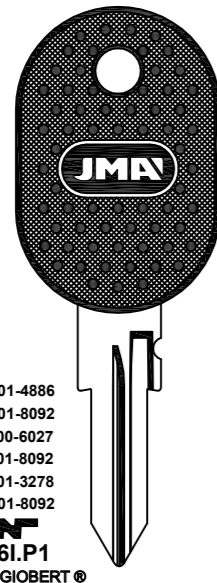

K 3301-4886
K 7001-8092
T 5000-6027
T 7001-8092
S 0501-3278
H 7001-8092

FOR:
FERRARI®
FIAT®
INNOCENTI®
LANCIA®



FI-6I.P1

FOR: GIOBERT®

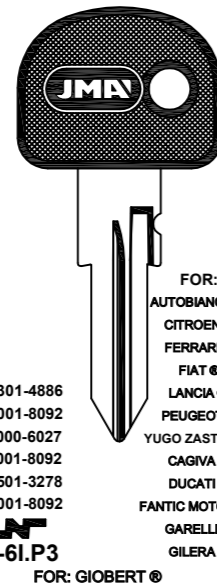

K 3301-4886
K 7001-8092
T 5000-6027
T 7001-8092
S 0501-3278
H 7001-8092

FOR:
AUTOBIANCHI®
CITROEN®
FERRARI®
FIAT®
LANCIA®
PEUGEOT®
YUGO ZASTAVA
CAGIVA®
DUCATI®
FANTIC MOTOR®
GARELLI®
GILERA®



FI-6I.P3

FOR: GIOBERT®

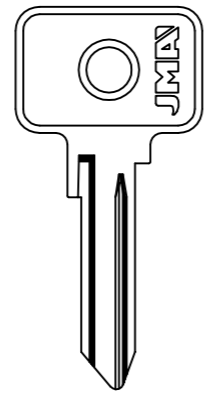

Y
7001-9956



FI-8I

FOR: GIOBERT®

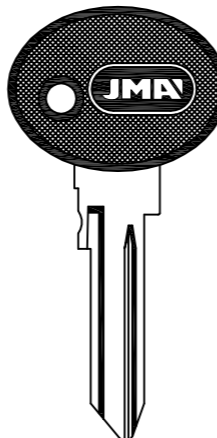

Y
7001-9956



FI-8I.P

FOR: GIOBERT®

FOR: ARMAN®

FOR: FORD®

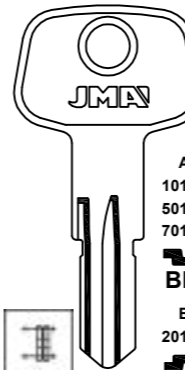

A...
101-125
501-598
701-790



BL-2

B...

201-225



BL-3



BL-4

A 201-225



BL-6

FOR: BLAU®

FOR: FORT® -HK® -WASO®

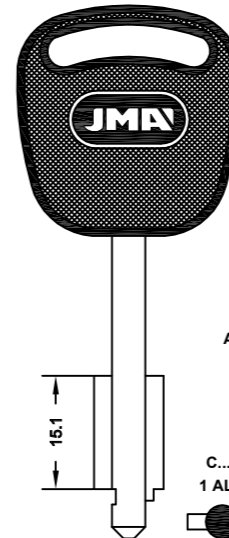

ACE.

C....
1 AL 5



FO-4.P

FOR: FORD®

FOR: KOLB®

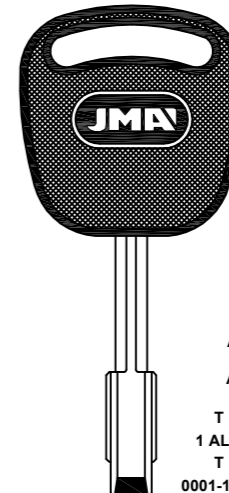

ALP.

ACE.

T
1 AL 4

T

FOR: FORD®

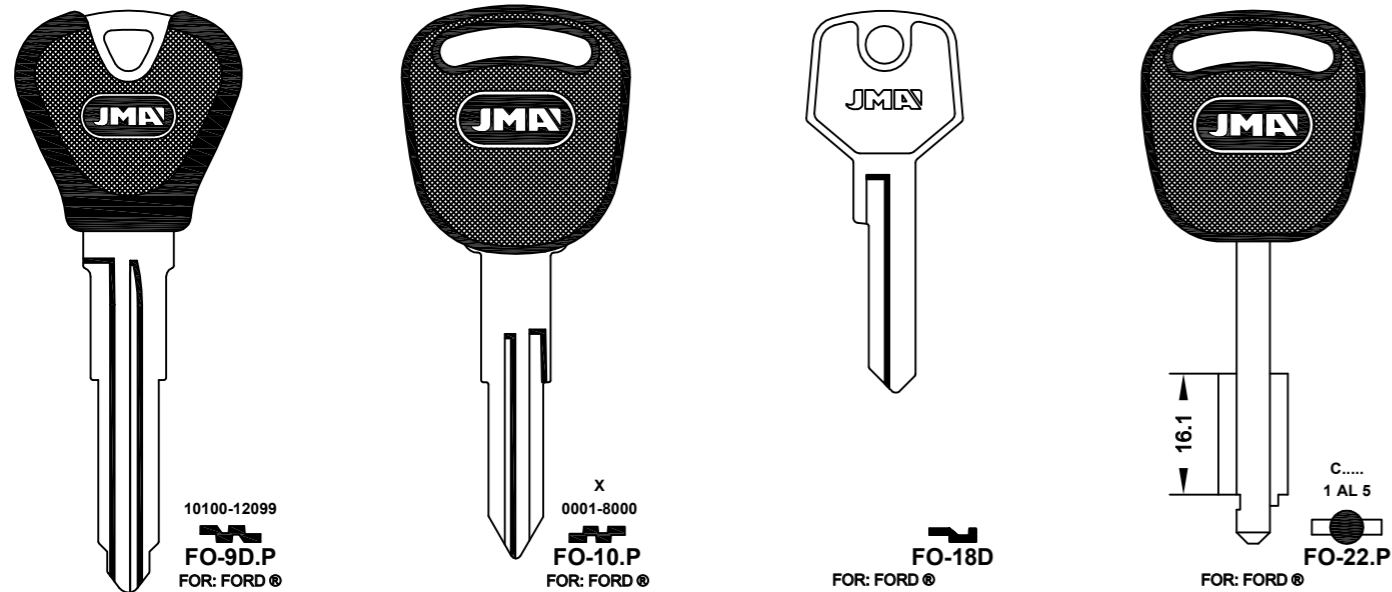

FOR: FORD®

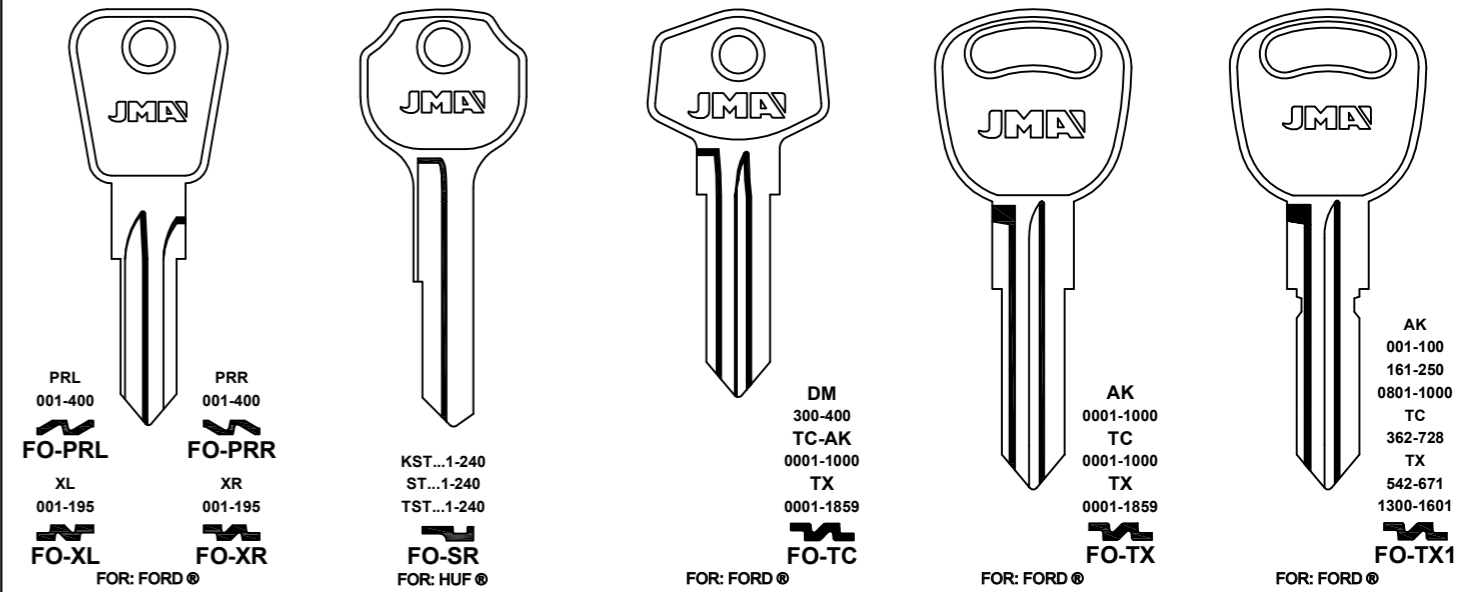

FOR: FORD®

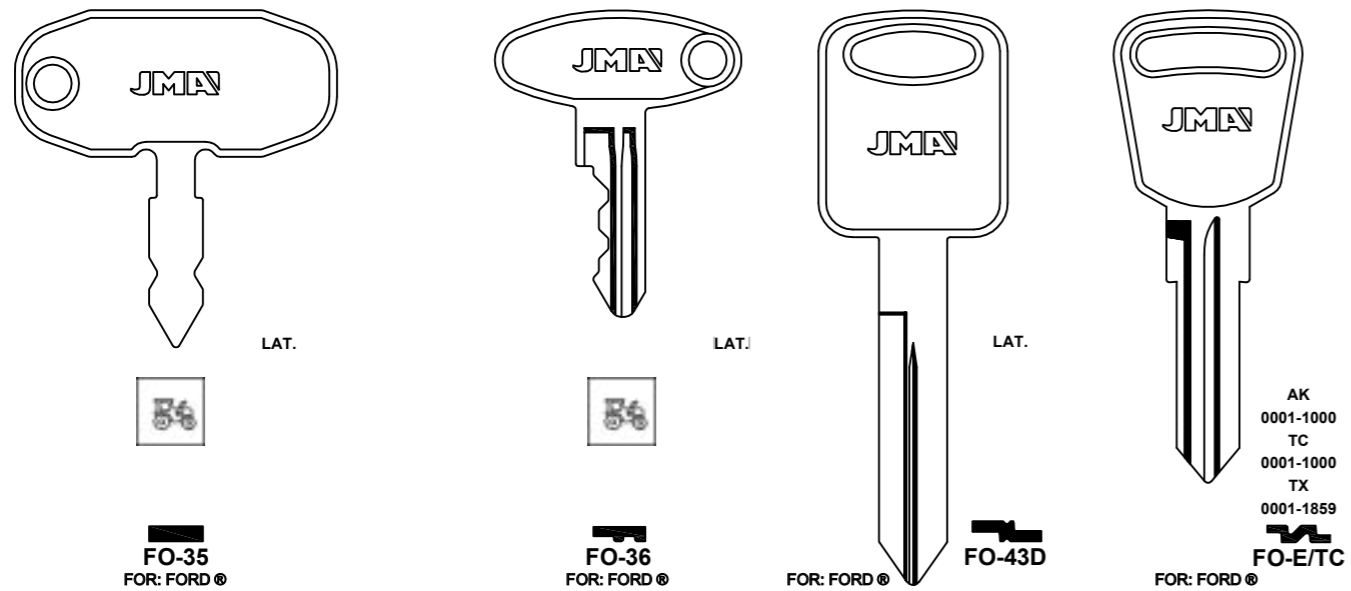

FOR: FORD®

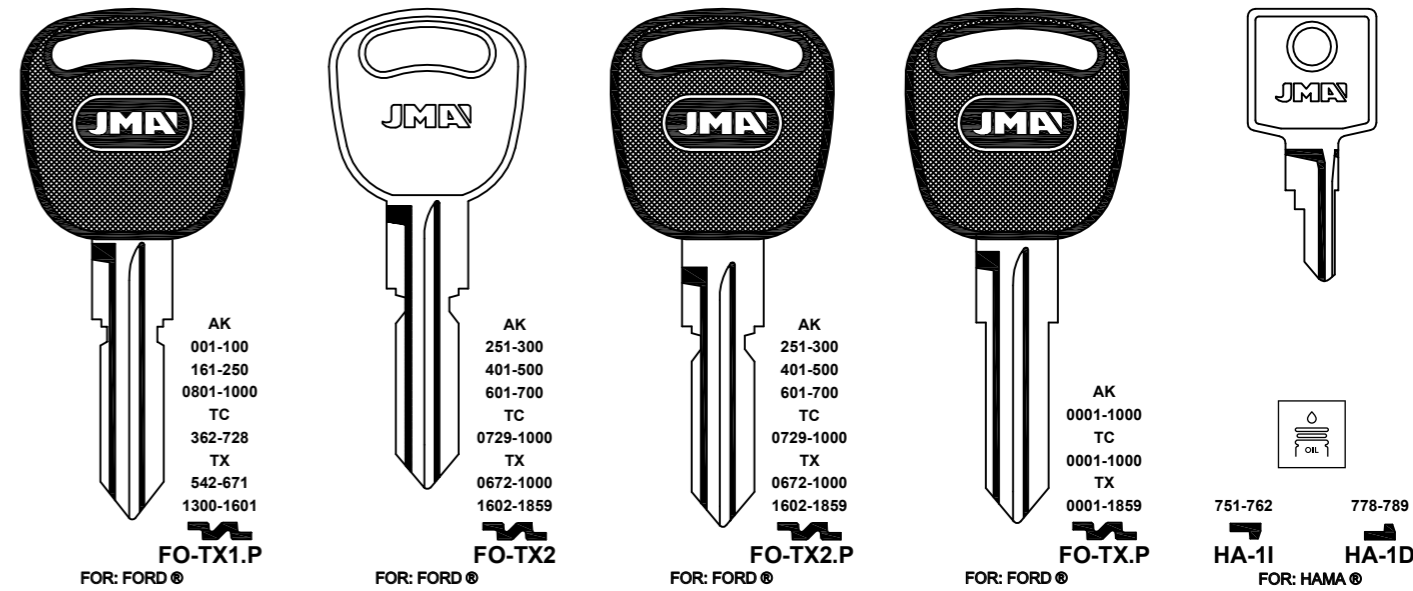

FOR: FORD®

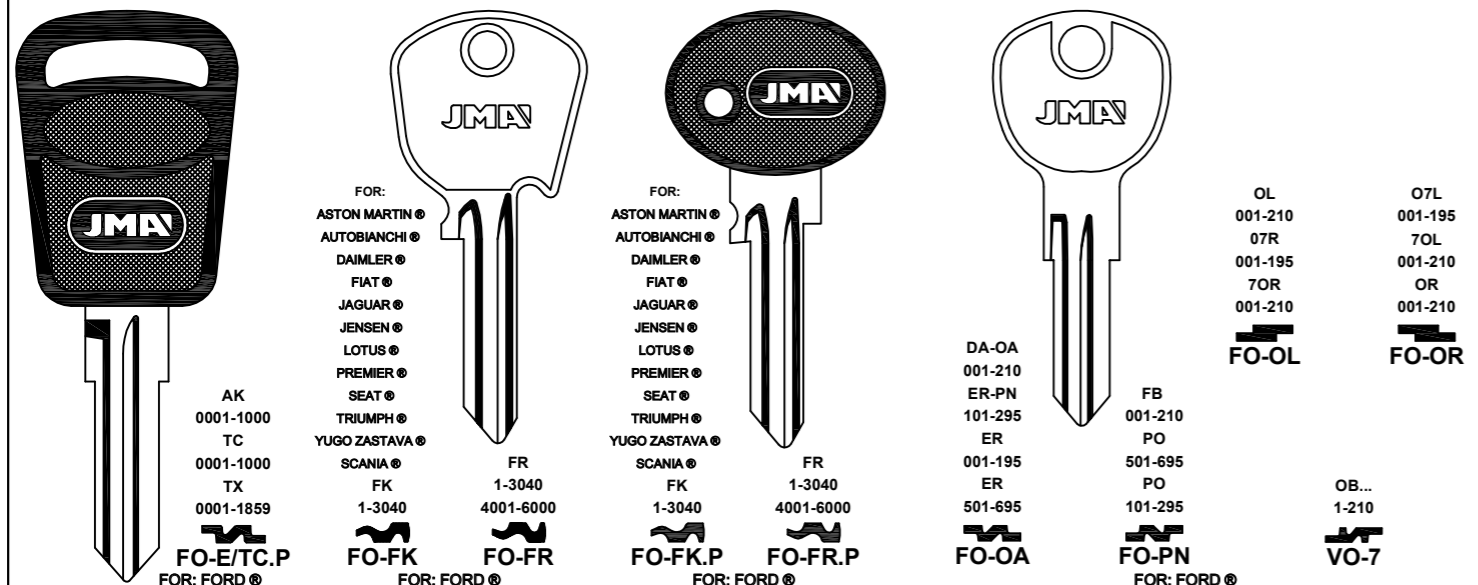

FOR: FORD®

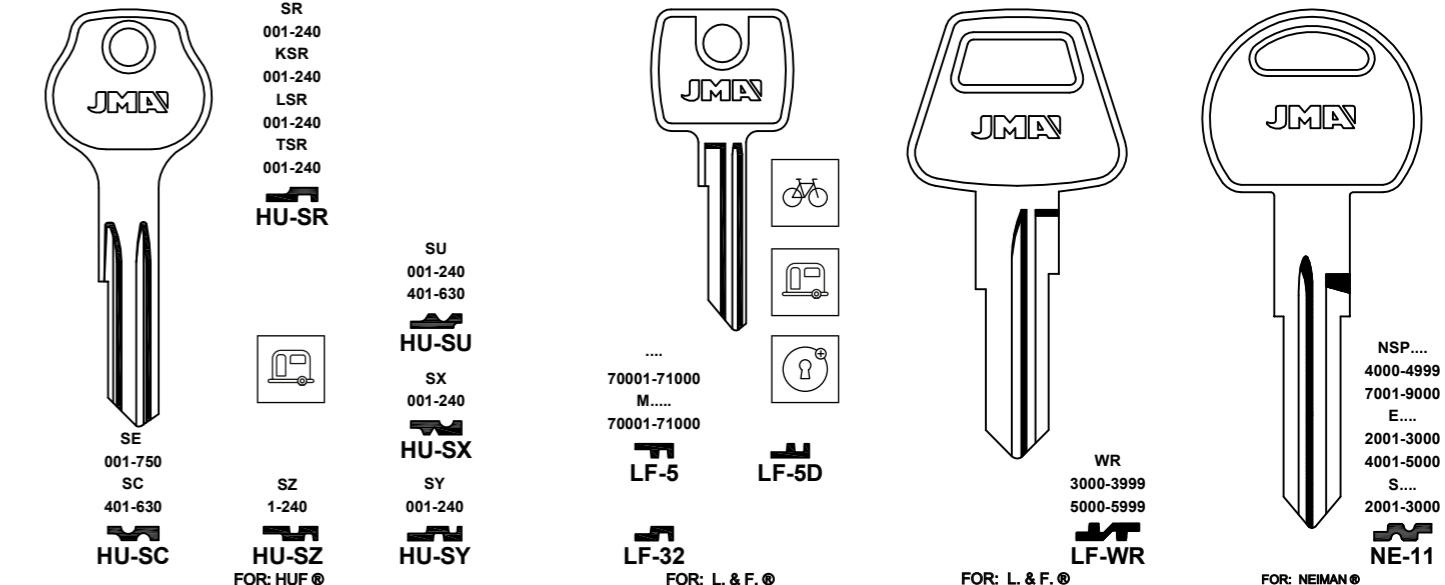

Concerning the marks and commercial denominations see legal warning.
 Concerniente a las marcas y denominaciones comerciales ver aviso legal.
 Marka eta izendapen komertzialiei dagokienez, ikus lege-oharra.
 Concernant les marques et denominations commerciales voir la note dans l'index.

JMA Opening the future

JMA Opening the future

Beziehen auf die marke und handelsname sehen sie die notiz im Impressum.
 Relativamente às marcas e denominações comerciais, ver aviso legal.
 Jeśli chodzi o znaki i nazwy handlowe, patrz Informacje prawne.

FOR: FORD®

NSP...
4000-4999
7001-9000
E...
2001-3000
4001-5000
S...
2001-3000
NE-11.P
FOR: NEIMAN®

NSP...
4000-4999
7001-9000
E...
2001-3000
4001-5000
S...
2001-3000
NE-24
FOR: NEIMAN®

NSP...
4000-4999
7001-9000
E...
2001-3000
4001-5000
S...
2001-3000
NE-24.P
FOR: NEIMAN®

FT-BC...301-360
BC-FT...101-225
LF...451-575
CB...801-875
UN-FT
FOR: UNION®

TF...1001-1140
UN-TF
FOR: CEM®

FOR: FORD(ARG.)®

A...
101-125
501-598
701-790
BL-2
B...
201-225
BL-3
A
BL-4
BL-6
FOR: BLAU®
FOR: FORT® -HK® -WASO®

B...
101-125
BL-4D
BL-6D

FOR: FORD (ARGENTINA)®

AK
0001-1000
TC
0001-1000
TX
0001-1859
FO-E/TC.P
FOR: FORD®
FOR: CASI® -CEM® -CLAUSOR® -KOLB® -NEIMAN®

DM
300-400
TC-AK
0001-1000
TX
0001-1859
FO-TC
FOR: FORD®
FOR: CASI® -CEM® -KOLB®

AK
0001-1000
TC
0001-1000
TX
0001-1859
FO-TX
FOR: FORD®
FOR: CASI® -CEM® -CLAUSOR® -KOLB® -NEIMAN®

AK
001-100
161-250
0801-1000
TC
362-728
TX
542-671
1300-1601
FO-TX1
FOR: FORD®

FOR: FORD (ARGENTINA)®

FOR: FB® -PB®
0000-1863
FO-1
FO-3
FO-3D
FOR: FORD®

AF
0001-2600
FA-PA
0000-1863
FO-2
FOR: FORD®

ACE.
15.1
C...
1 AL 5
FO-4.P
FOR: FORD®
FOR: KOLB®

ALP.
ACE.
T
1 AL 4
T
0001-1050
FO-6.P
FOR: FORD®
FOR: HUF®

FOR: FORD (ARGENTINA)®

AK
001-100
161-250
0801-1000
TC
362-728
TX
542-671
1300-1601
FO-TX1.P
FOR: FORD®
FOR: CASI® -CEM® -CLAUSOR® -KOLB® -NEIMAN®

AK
251-300
401-500
601-700
TC
0729-1000
TX
0672-1000
1602-1859
FO-TX2
FOR: FORD®

AK
251-300
401-500
601-700
TC
0729-1000
TX
0672-1000
1602-1859
FO-TX2.P
FOR: FORD®
FOR: CASI® -CEM® -CLAUSOR® -KOLB® -NEIMAN®

AK
0001-1000
TC
0001-1000
TX
0001-1859
FO-TX.P
FOR: FORD®

GAS-1
GAS-1D
FOR: GAS®

FOR: FORD (ARGENTINA)®

A
101-291
501-579
B
101-332
501-602
C
101-344
501-624
D
101-327
501-602
E
101-296
501-579
FA
6500-7733
FO-11D
FOR: FORD®

...X
0001-1706
FO-15D.P
FOR: FORD®

HV...
1-8154
1001-9282
FO-17.P
FOR: FORD®

AN
001-854
1001-1918
2001-2830
3001-3890
4001-5151
6001-7086
7001-8154
8201-9282
FO-AN.P
FOR: FORD®

AK
0001-1000
TC
0001-1000
TX
0001-1859
FO-E/TC
FOR: FORD®
FOR: CASI® -CEM® -CLAUSOR® -KOLB® -NEIMAN®

FOR: FORD (ARGENTINA)®

AH...
1-8154
1001-9282
VO-AH
FOR: HUF®

HV...
1-8154
1001-9282
VO-HV.P1
2FF
VO-8.P
AH...
1-8154
1001-9282
VO-2.P
FOR: HUF®
FOR: AKS® -CASI® -UBE® -WITTE®

AN...
001-854
1001-1918
2001-2830
3001-3890
4001-5151
6001-7086
7001-8154
8201-9282
AU-AN
FOR: HUF®
FOR: AKS® -CASI® -UBE® -WITTE®

AH...
1-8154
1001-9282
VO-AH.P
FOR: HUF®

HV...
1-8154
1001-9282
VO-HV.P
VB-NV-MD...
1-8154
1001-9282
VO-VB.P
N...
VO-N.P
FOR: HUF®
FOR: AKS® -CASI® -UBE® -WITTE®

AN...
001-854
1001-1918
2001-2830
3001-3890
4001-5151
6001-7086
7001-8154
8201-9282
AU-AN.P
FOR: HUF®
FOR: AKS® -CASI® -UBE® -WITTE®

Concerning the marks and commercial denominations see legal warning.
Concuerne a las marcas y denominaciones comerciales ver aviso legal.
Marka eta izendapen komertzialiei dagokienez, ikus lege-oharra.
Concernant les marques et denominations commerciales voir la note dans l'index.

JMA Opening the future

JMA Opening the future

Beziehen auf die marke und handelsname sehen sie die notiz im Impressum.
Relativamente às marcas e denominações comerciais, ver aviso legal.
Jeśli chodzi o znaki i nazwy handlowe, patrz Informacje prawne.

FOR: FORD (AUSTRALIA) ®

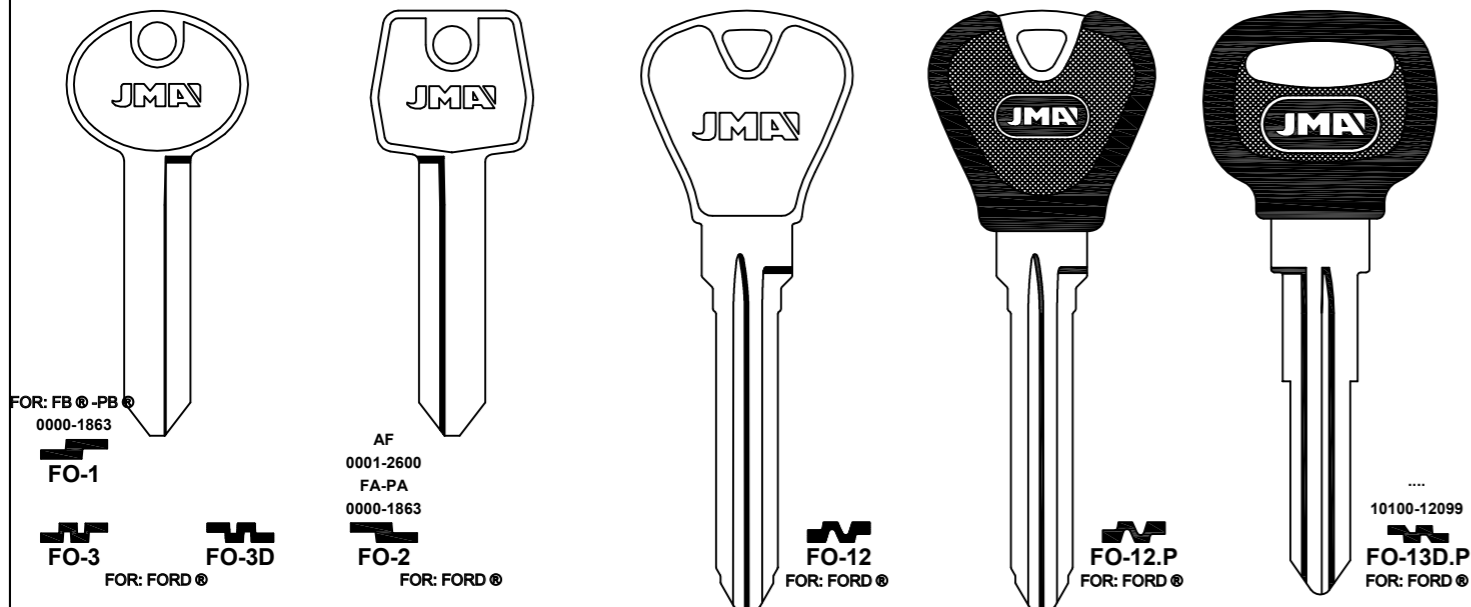

FOR: FORD (AUSTRALIA) ®

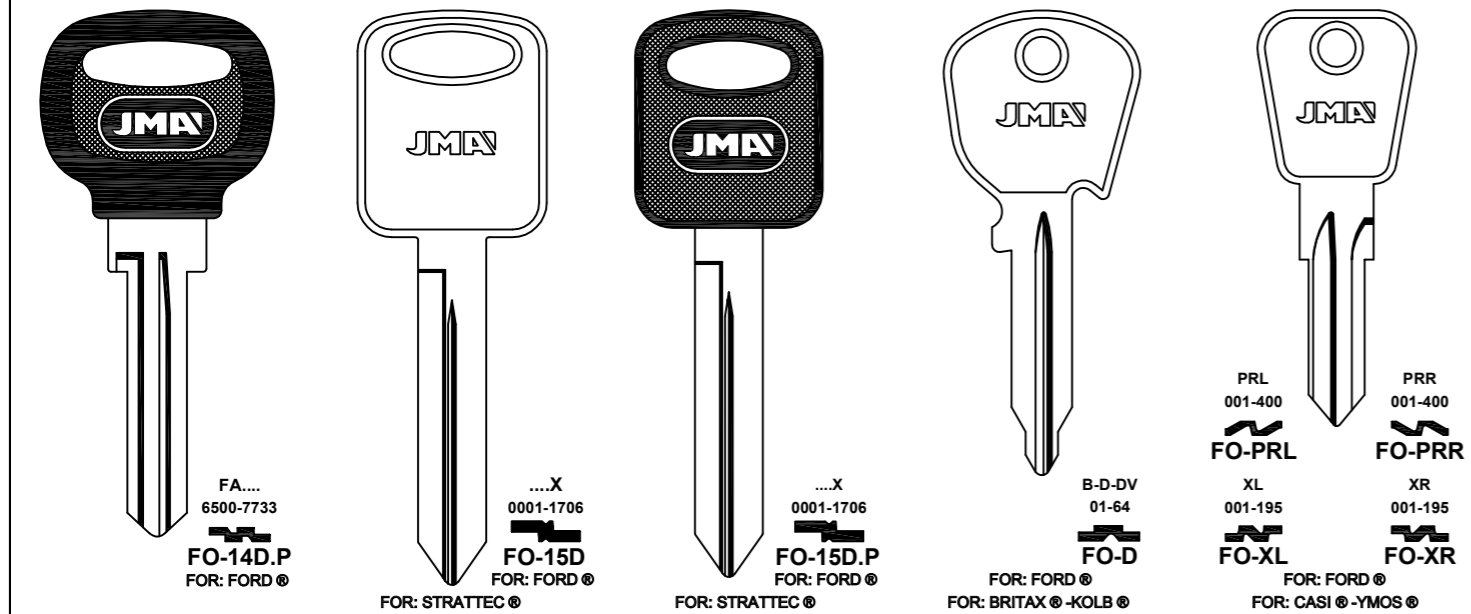

FOR: FORD (AUSTRALIA) ®

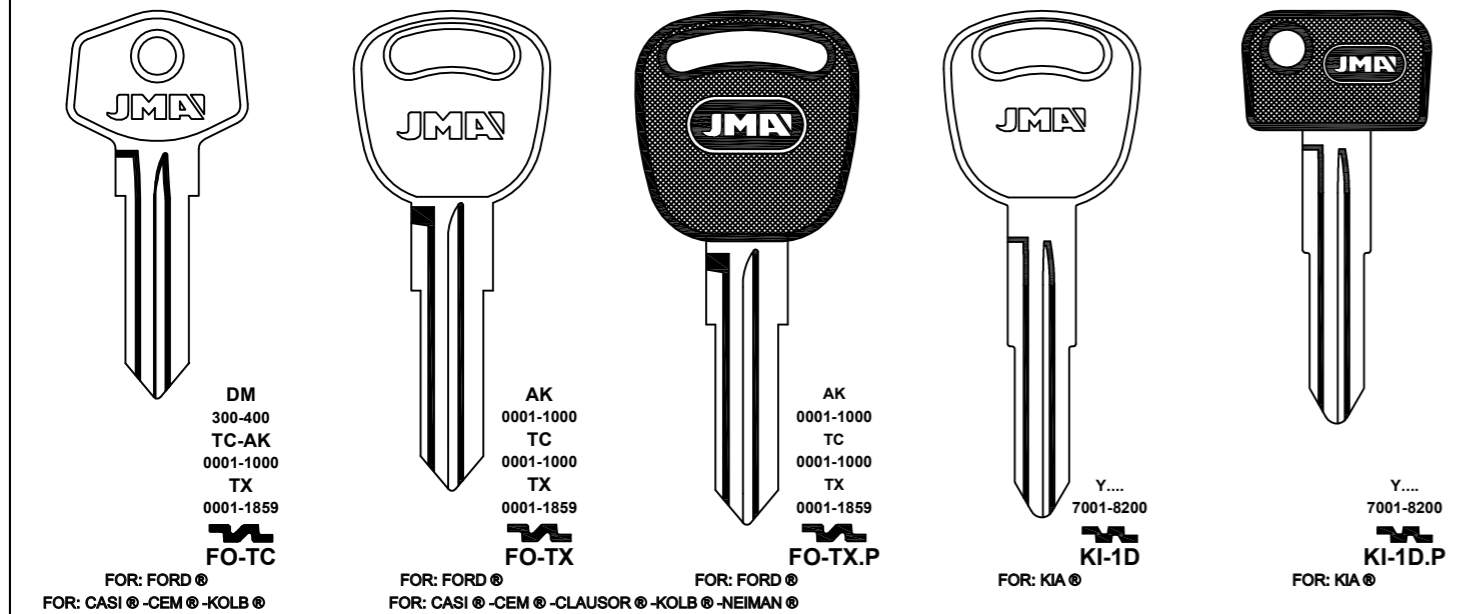

FOR: FORD (AUS.) ®

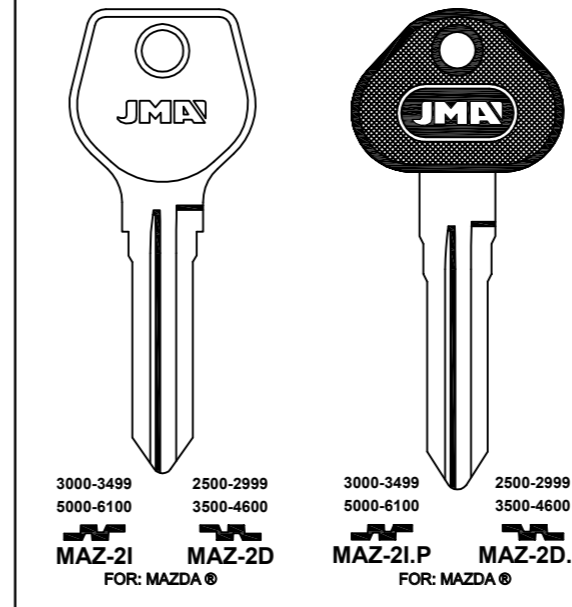

FOR: FORD (BRASIL) ®

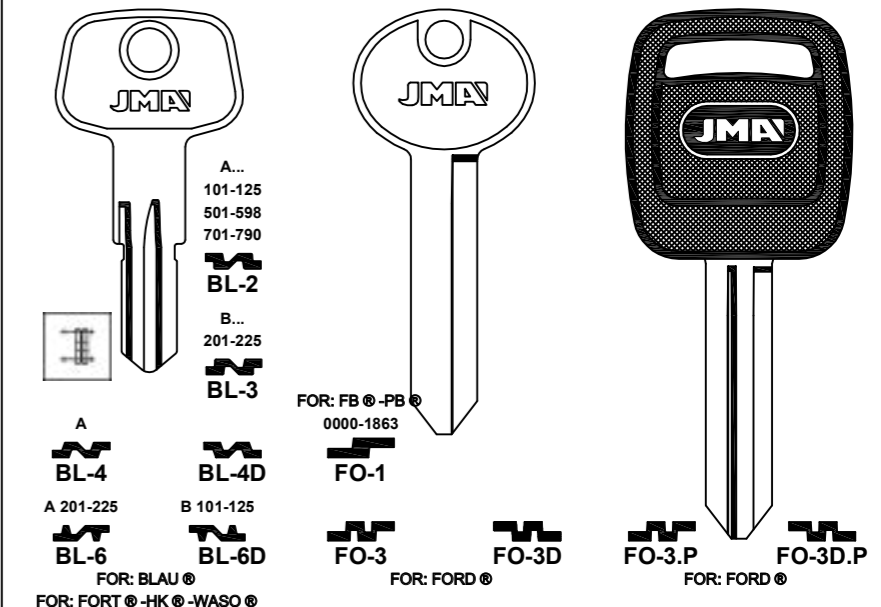

FOR: FORD (BRASIL) ®

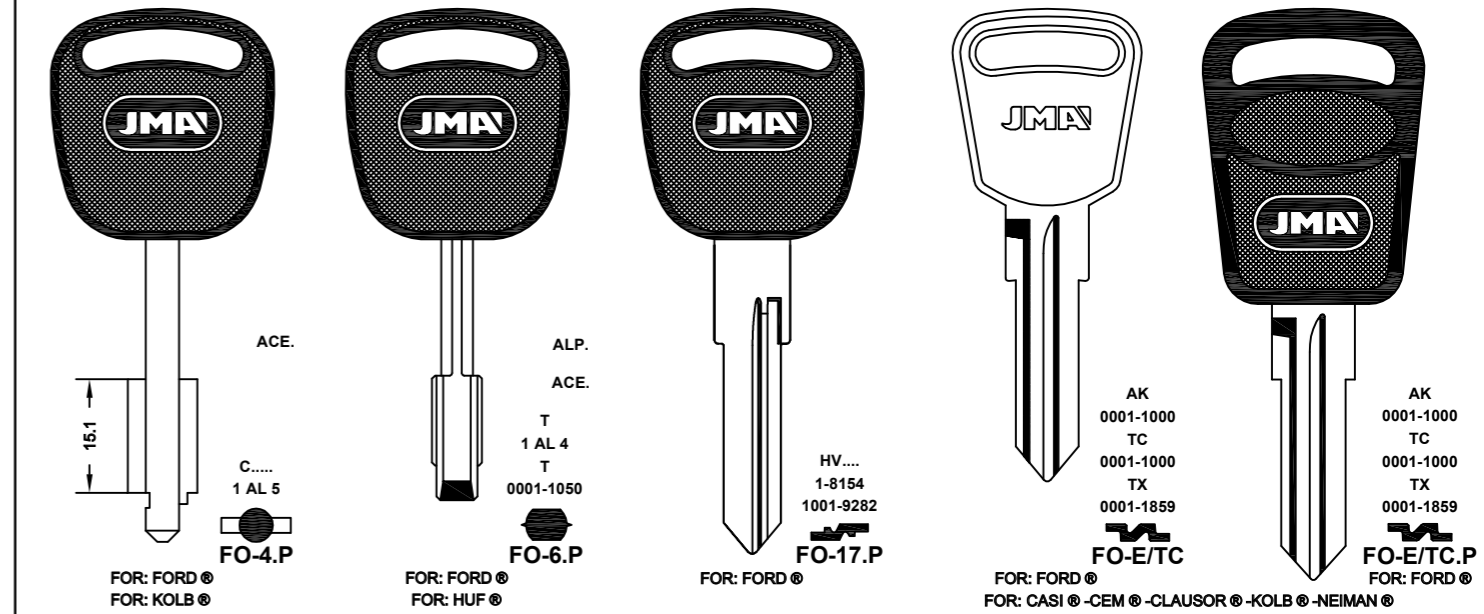

FOR: FORD (BRASIL) ®

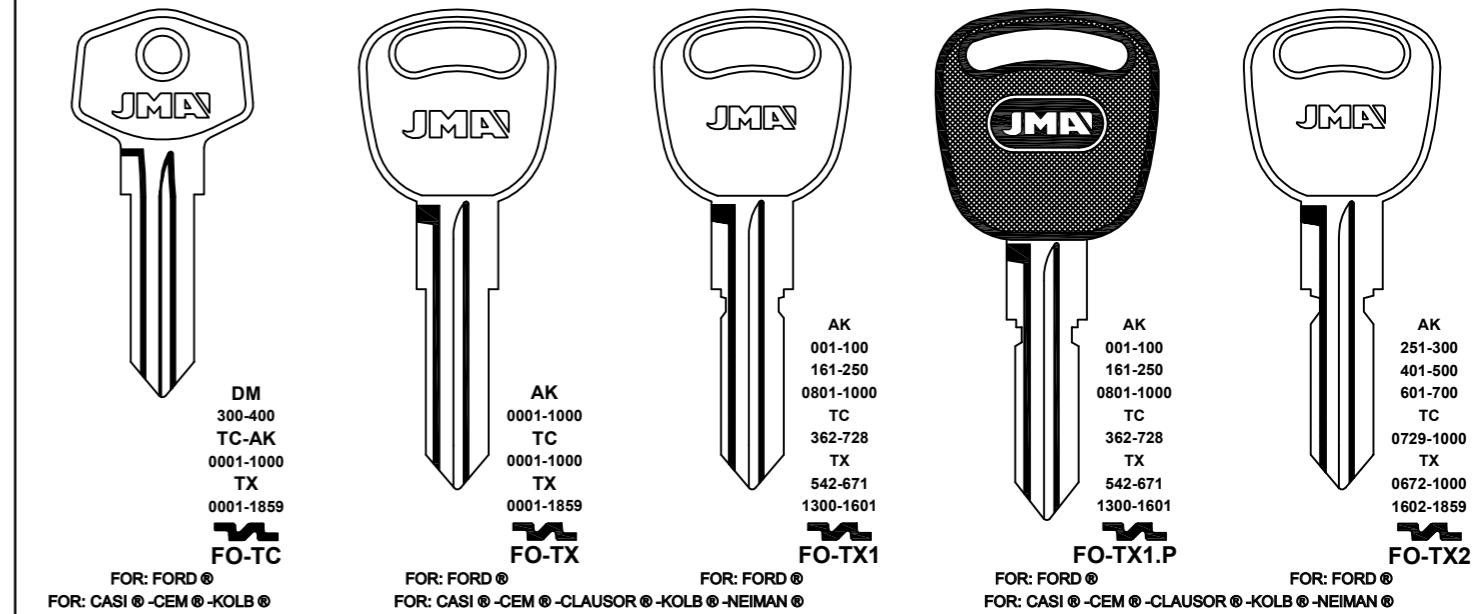

Concerning the marks and commercial denominations see legal warning.
Concerniente a las marcas y denominaciones comerciales ver aviso legal.
Marka eta izendapen komertzialiei dagokienez, ikus lege-oharra.
Concernant les marques et dénominations commerciales voir la note dans l'index.

JMA Opening the future

JMA Opening the future

Beziehen auf die Marke und Handelsname sehen Sie die Notiz im Impressum.
Relativamente às marcas e denominações comerciais, ver aviso legal.
Jeśli chodzi o znaki i nazwy handlowe, patrz Informacje prawne.

FOR: FORD (BRASIL) ®

FOR: FORD (SOUTH AFRICA) ®

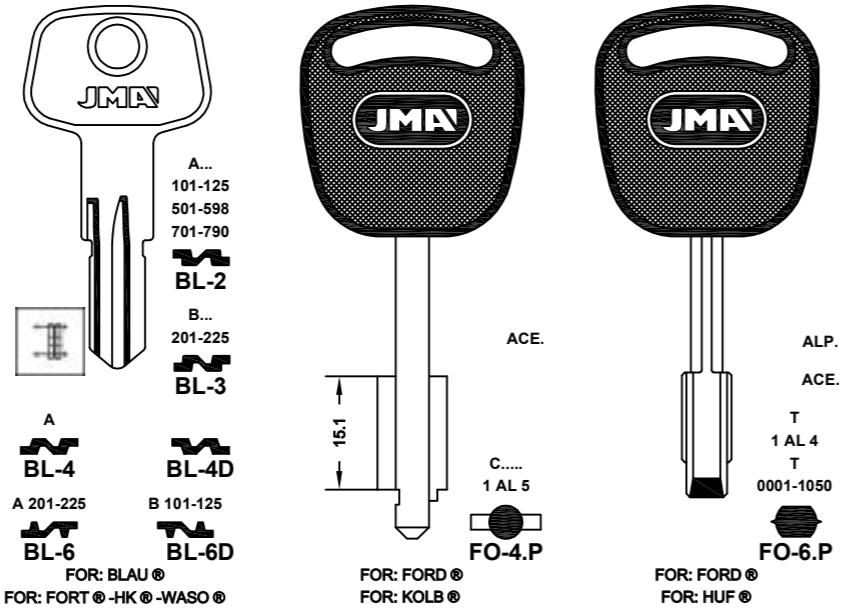
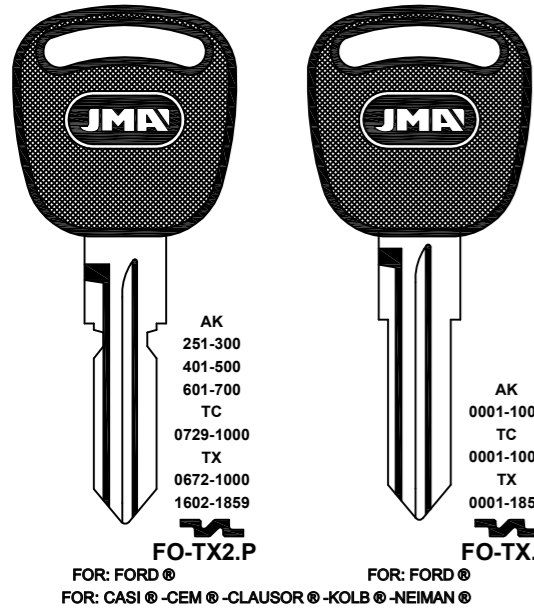

FOR: FORD (USA) ®

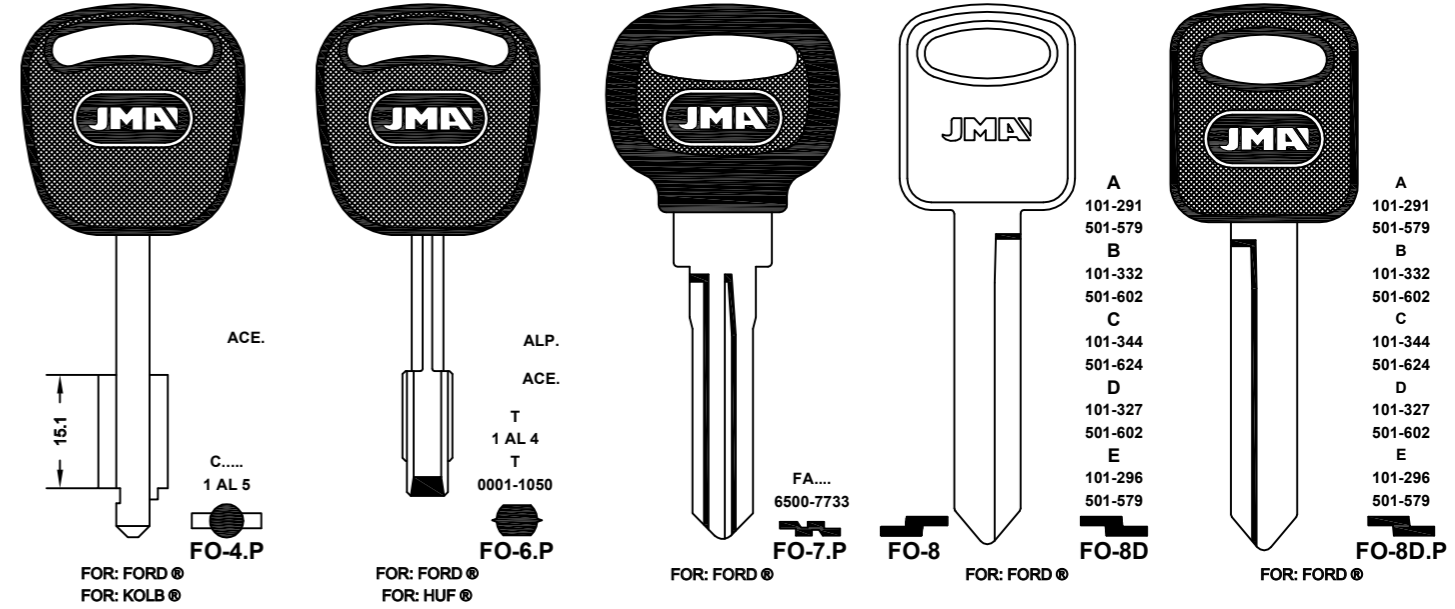

FOR: FORD (SOUTH AFRICA) ®

FOR: FORD (USA) ®

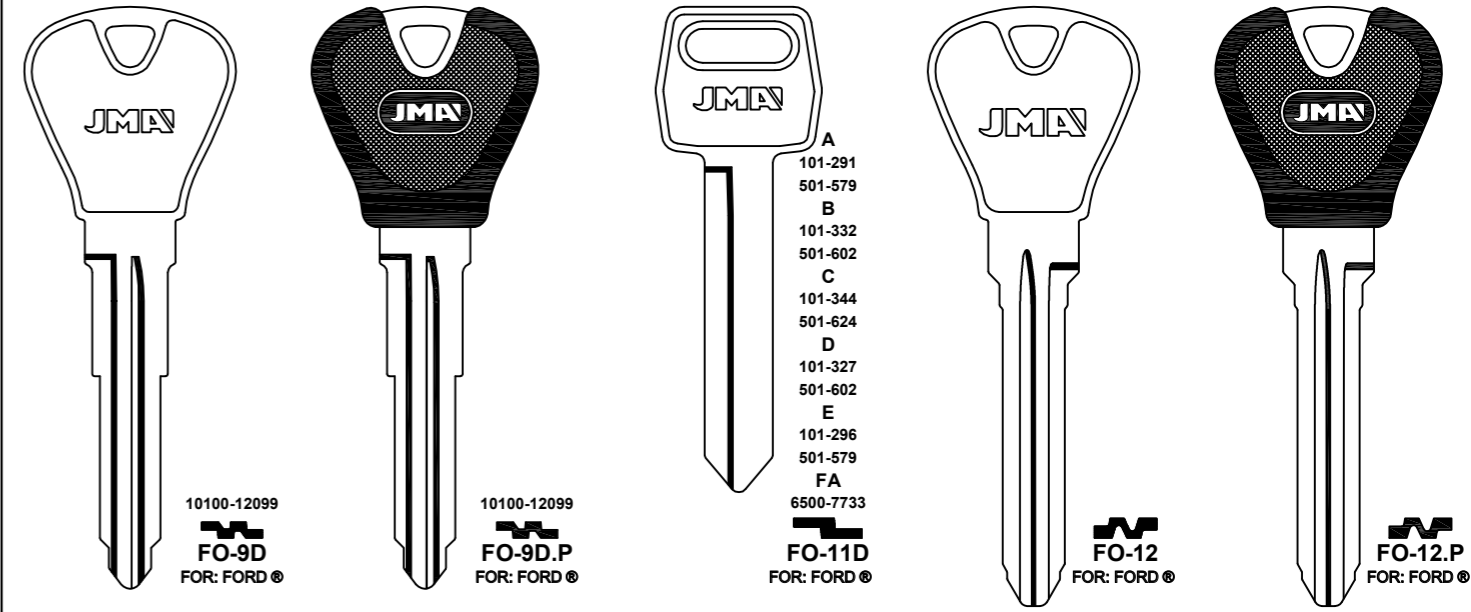
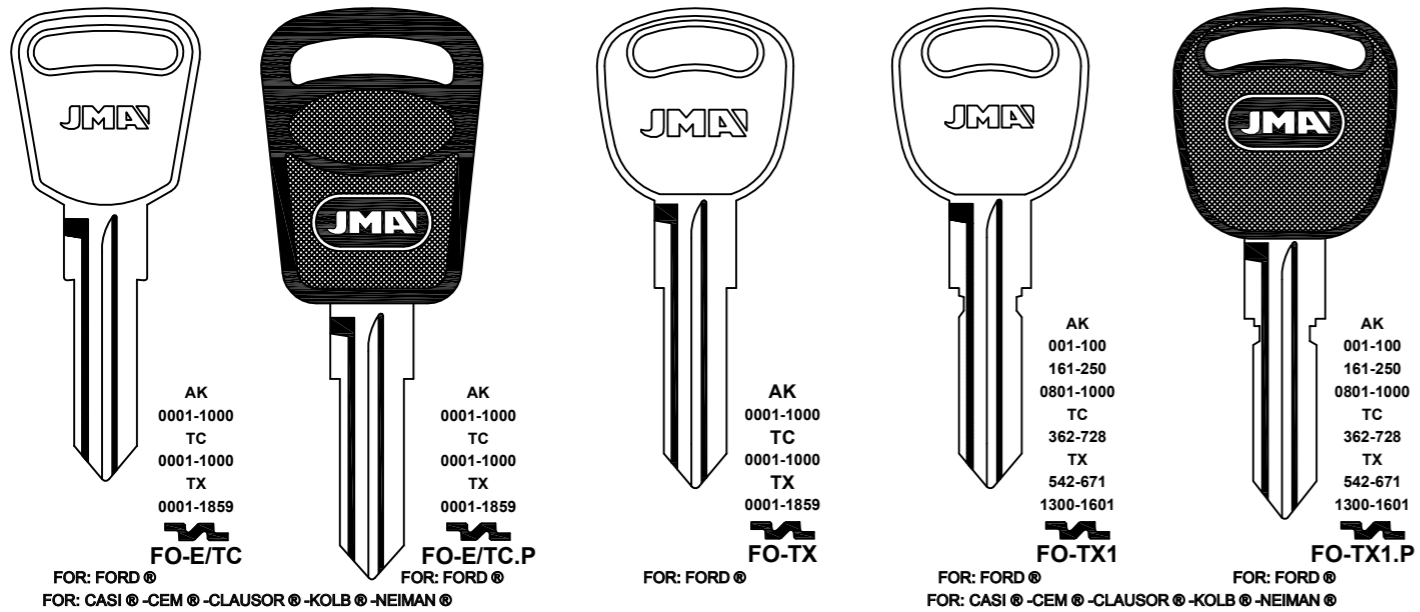

FOR: FORD (SOUTH AFRICA) ®

FOR: FORD (USA) ®

FOR: FORD (USA) ®

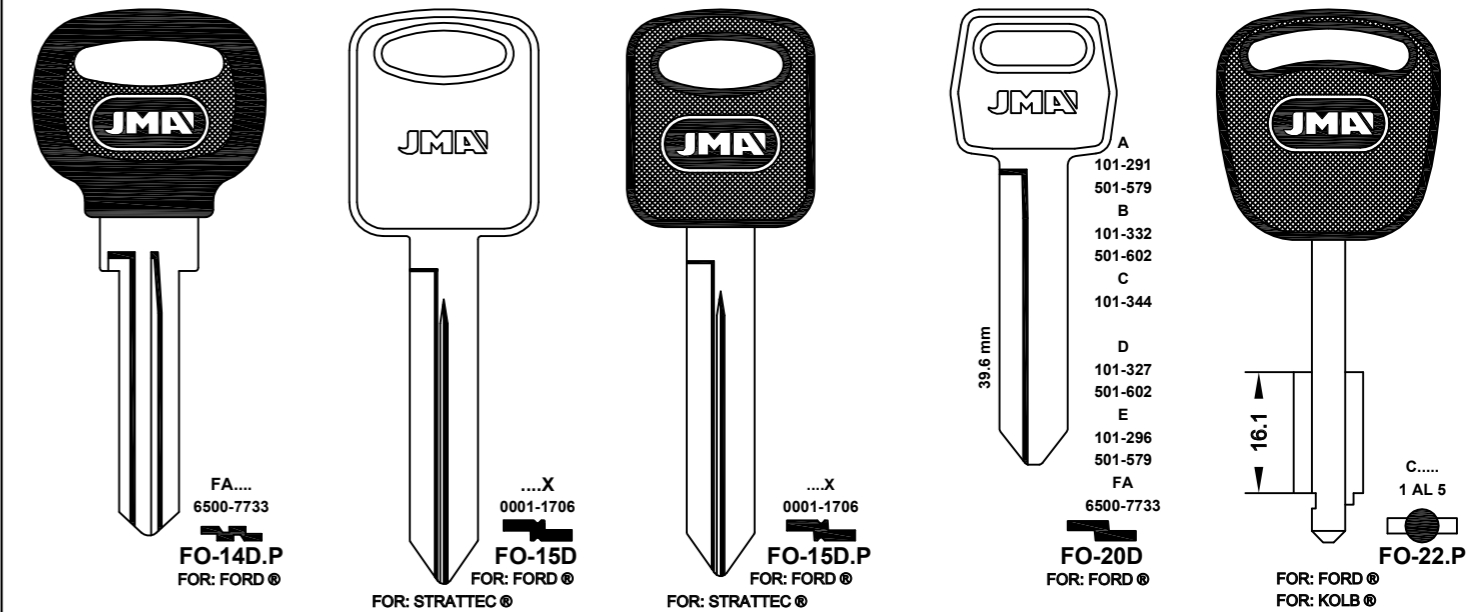
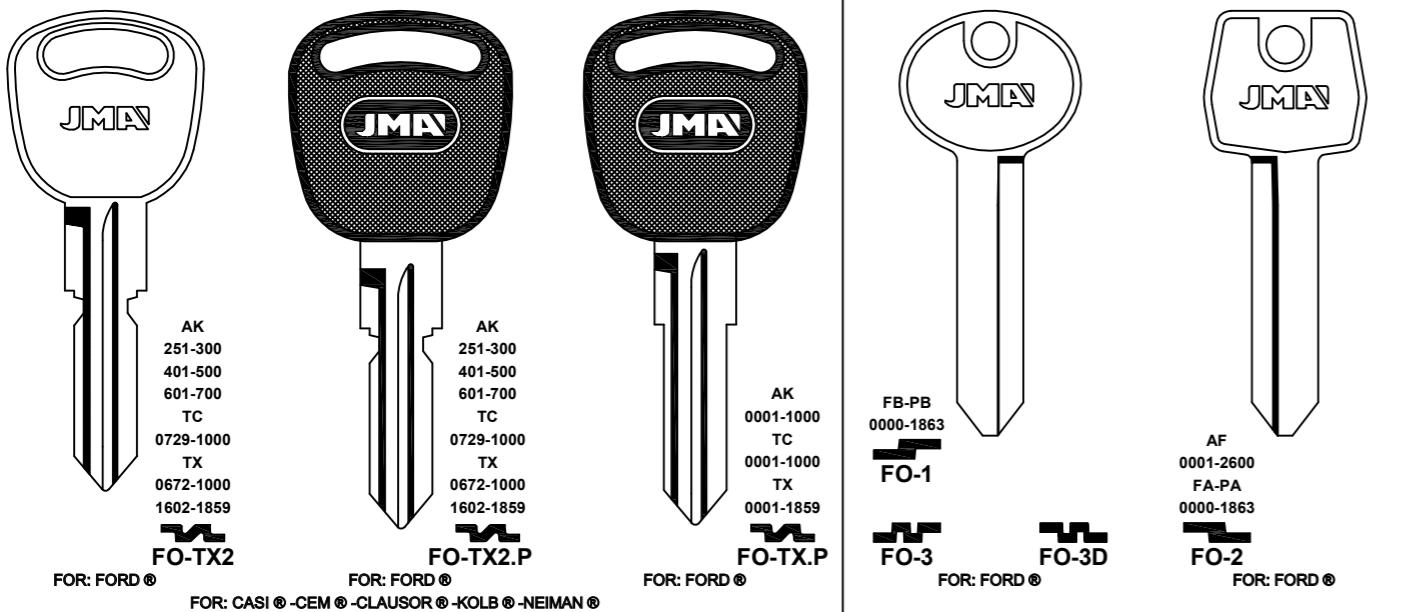

Concerning the marks and commercial denominations see legal warning.
 Concerniente a las marcas y denominaciones comerciales ver aviso legal.
 Marka eta izendapen komertzialiei dagokienez, ikus lege-oharra.
 Concernant les marques et denominations commerciales voir la note dans l'index.

JMA Opening the future

JMA Opening the future

Beziehen auf die marke und handelsname sehen sie die notiz im Impressum.
 Relativamente às marcas e denominações comerciais, ver aviso legal.
 Jeśli chodzi o znaki i nazwy handlowe, patrz Informacje prawne.

FOR: FORD (USA) ®

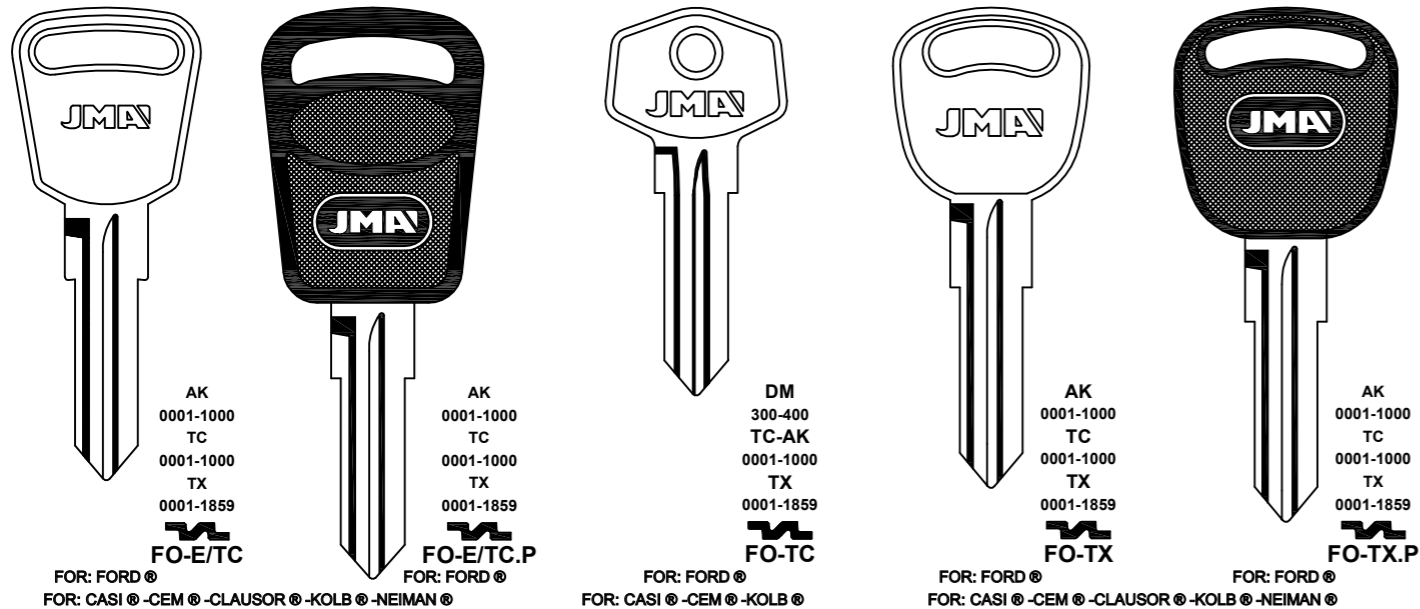

FOR: FORD (USA) ®

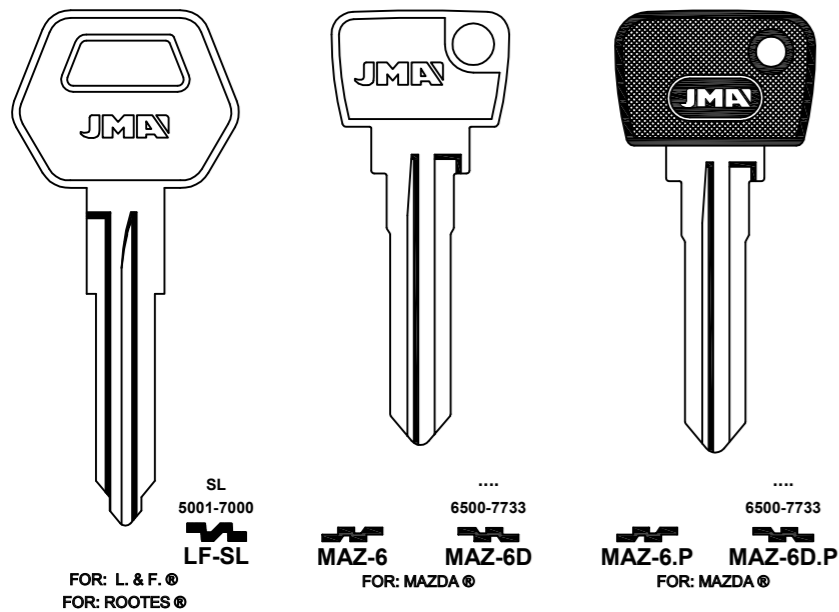

FOR: FREIGHTLINER ®

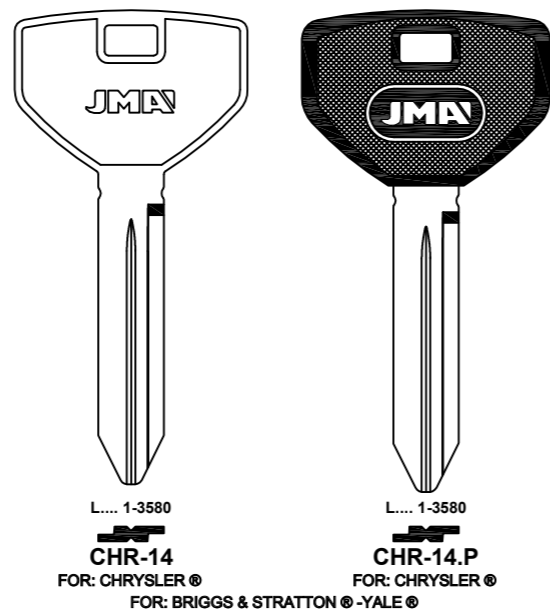

FOR: FREIGHTLINER ®

FOR: G.M. ®

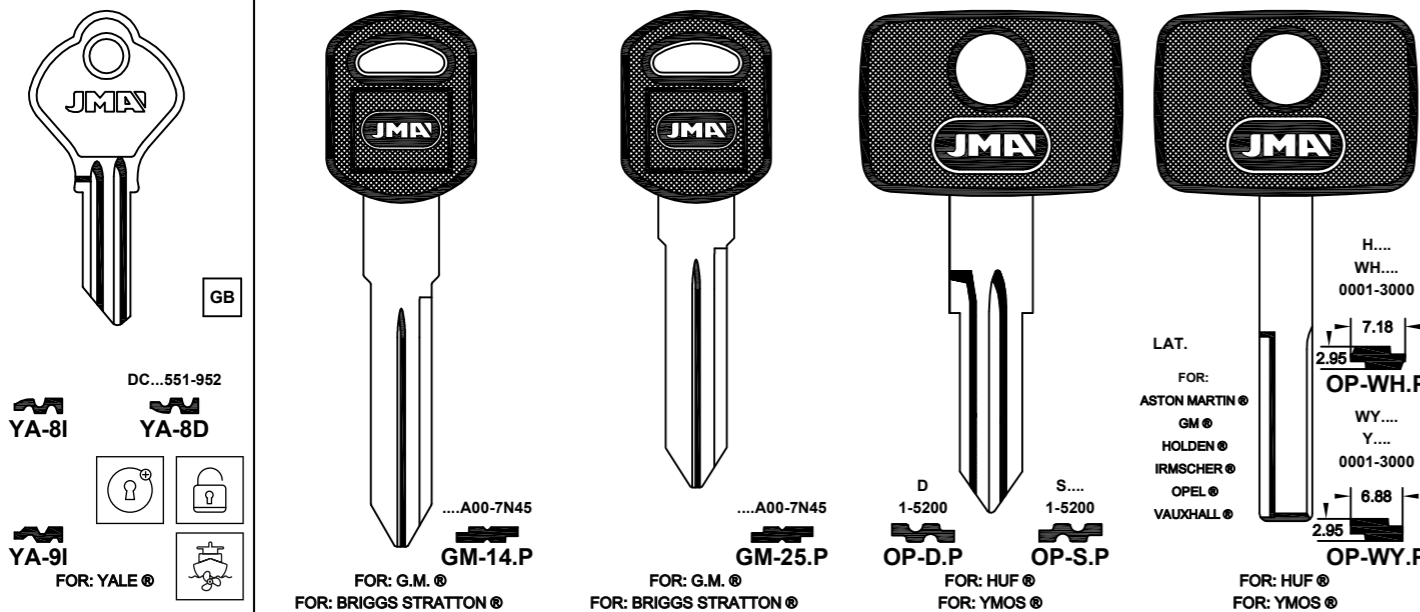

FOR: G.M. (BUICK) ®

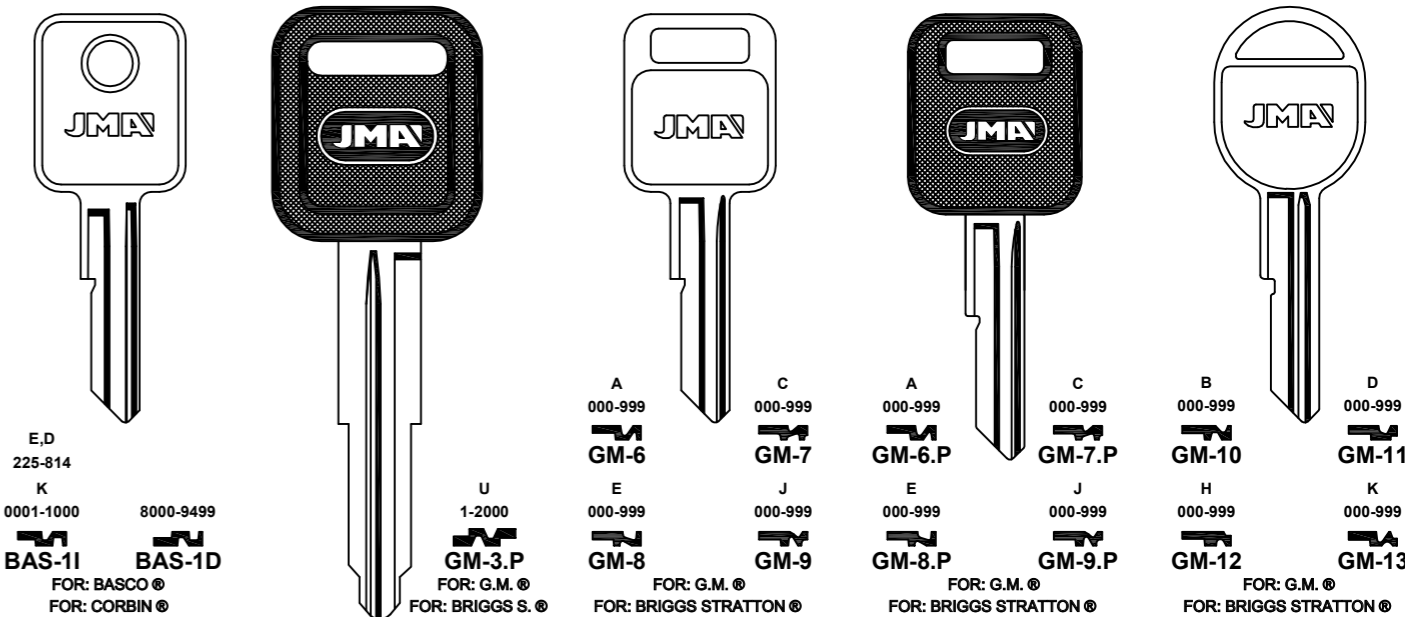

FOR: G.M. (BUICK) ®

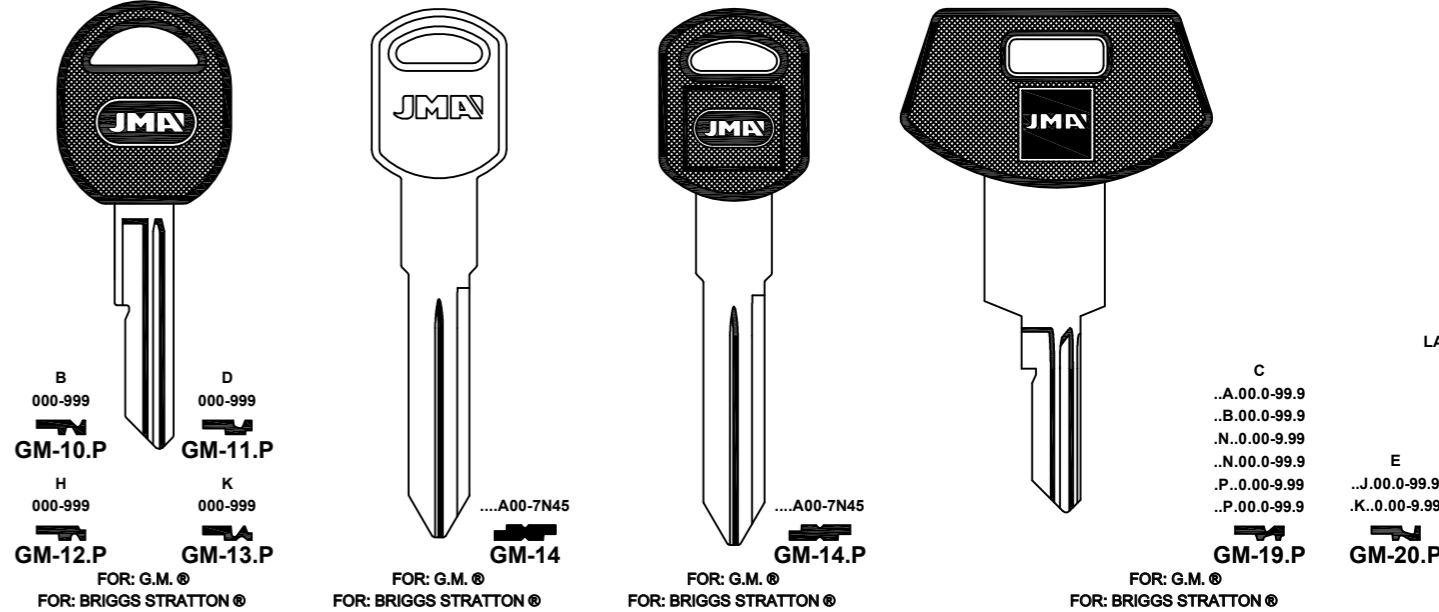

FOR: G.M. (BUICK) ®

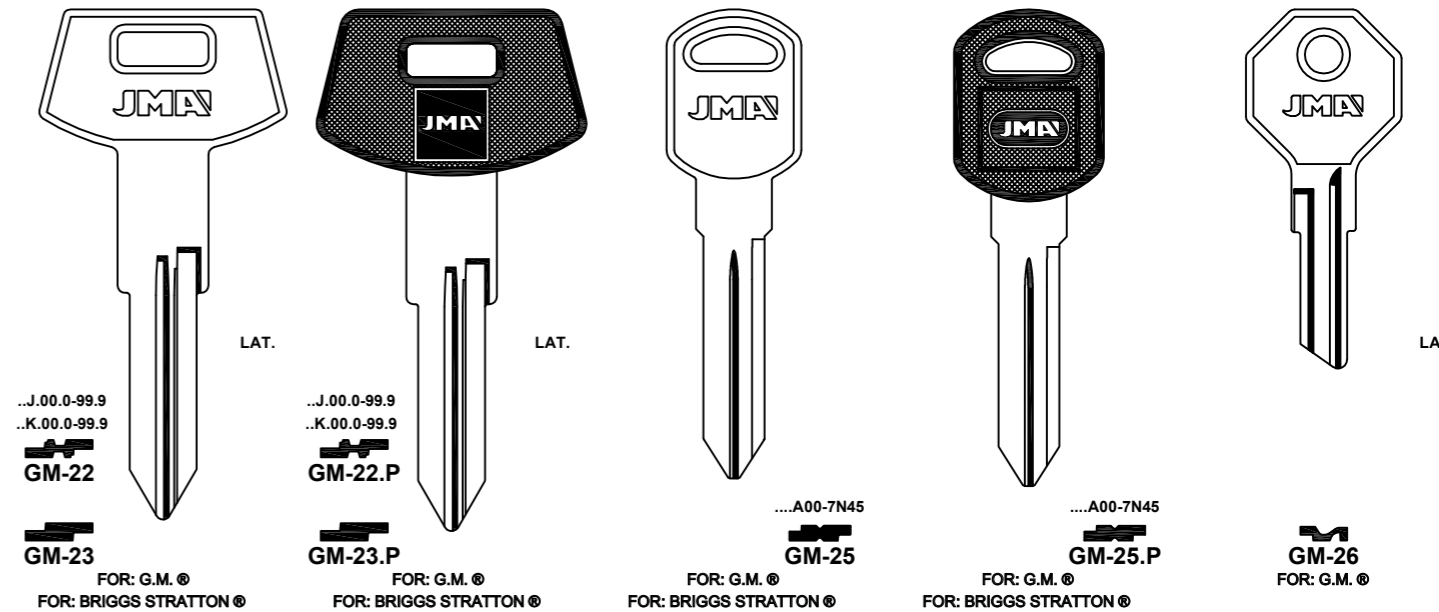

Concerning the marks and commercial denominations see legal warning.
 Concerniente a las marcas y denominaciones comerciales ver aviso legal.
 Marka eta izendapen komertzialiei dagokienez, ikus lege-oharra.
 Concernant les marques et denominations commerciales voir la note dans l'index.

JMA Opening the future

JMA Opening the future

Beziehen auf die marke und handelsname sehen sie die notiz im Impressum.
 Relativamente às marcas e denominações comerciais, ver aviso legal.
 Jeśli chodzi o znaki i nazwy handlowe, patrz Informacje prawne.

FOR: G.M. (BUICK)®

FOR: G.M.(CADIL.)®

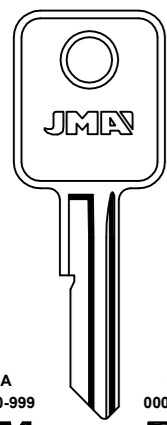

A
000-999
GM-A
E
000-999
GM-E

FOR: G.M.®
FOR: BRIGGS STRATTON®

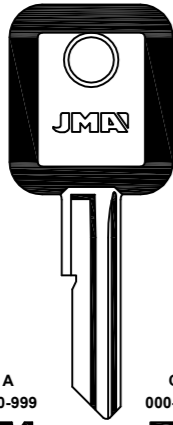

C
000-999
GM-C
J
000-999
GM-J

FOR: G.M.®
FOR: BRIGGS STRATTON®

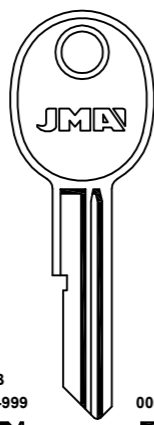

B
000-999
GM-B
H
000-999
GM-H

FOR: G.M.®
FOR: BRIGGS STRATTON®



D
000-999
GM-D
K
000-999
GM-K

FOR: G.M.®
FOR: BRIGGS STRATTON®

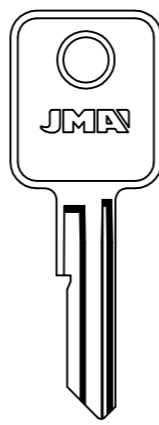

E,D
225-814
K
0001-1000
8000-9499
BAS-1I
BAS-1D

FOR: BASCO®
FOR: CORBIN®

FOR: G.M. (CADILLAC)®

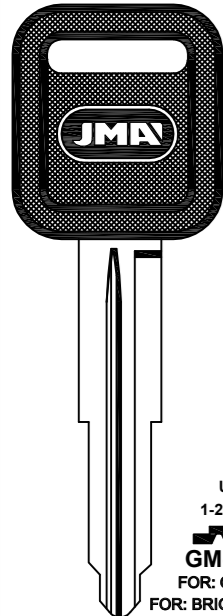

A
000-999
GM-6
E
000-999
GM-8

FOR: G.M.®
FOR: BRIGGS S.®

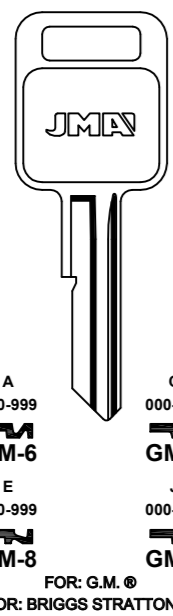

C
000-999
GM-7
J
000-999
GM-9

FOR: G.M.®
FOR: BRIGGS STRATTON®

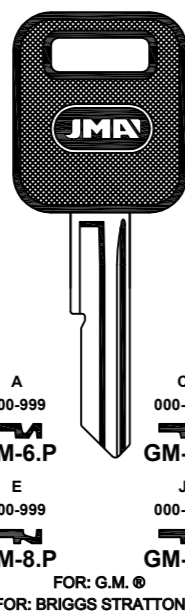

B
000-999
GM-10
H
000-999
GM-12

FOR: G.M.®
FOR: BRIGGS STRATTON®

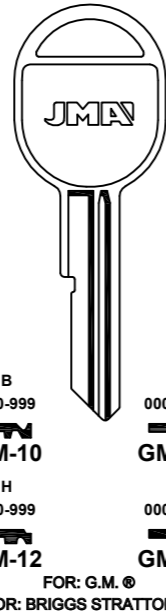

D
000-999
GM-11
K
000-999
GM-13

FOR: G.M.®
FOR: BRIGGS STRATTON®

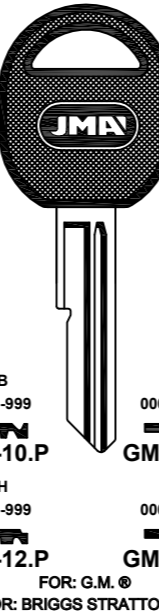

B
000-999
GM-10.P
H
000-999
GM-12.P

FOR: G.M.®
FOR: BRIGGS STRATTON®

FOR: G.M. (CADILLAC)®

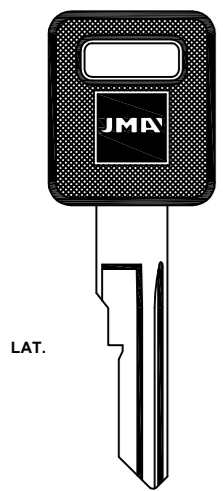

A
..A.00.0-99.9
..B.00.0-99.9
..V.00.0-99.9
..V.00.0-99.9
..W.00.0-99.9
..W.00.0-99.9

GM-16.P
E
..J.00.0-99.9
..K.00.0-99.9
GM-18.P

FOR: G.M.®
FOR: BRIGGS STRATTON®

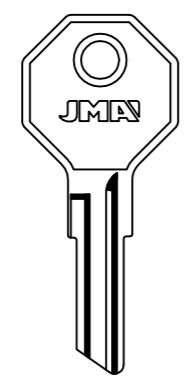

C
..A.00.0-99.9
..B.00.0-99.9
..N.00.0-99.9
..N.00.0-99.9
..P.00.0-99.9
..P.00.0-99.9

GM-17.P

GM-26

FOR: G.M.®

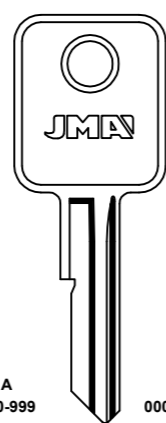

A
000-999
GM-A
E
000-999
GM-E

FOR: G.M.®
FOR: BRIGGS STRATTON®



C
000-999
GM-C
J
000-999
GM-J

FOR: G.M.®
FOR: BRIGGS STRATTON®

FOR: G.M. (CADILLAC)®

FOR: G.M. (CHEVROLET)®



B
000-999
GM-B
H
000-999
GM-H

FOR: G.M.®
FOR: BRIGGS STRATTON®



D
000-999
GM-D
K
000-999
GM-K

FOR: G.M.®
FOR: BRIGGS STRATTON®

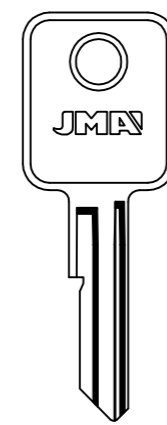

B
000-999
GM-B.P
H
000-999
GM-H.P

FOR: G.M.®
FOR: BRIGGS STRATTON®

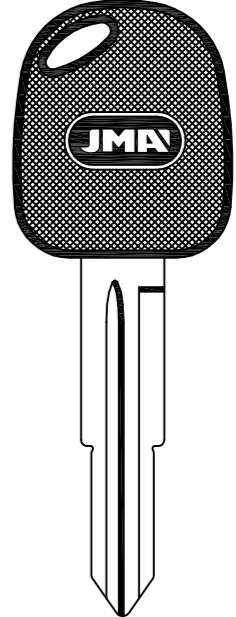

D
000-999
GM-D.P
K
000-999
GM-K.P

FOR: G.M.®
FOR: BRIGGS STRATTON®

FOR: G.M. (CHEVROLET)®

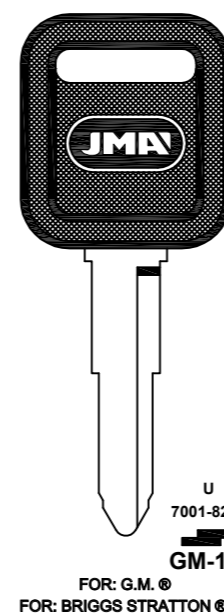

U
7001-8200
GM-1.P

FOR: G.M.®
FOR: BRIGGS STRATTON®

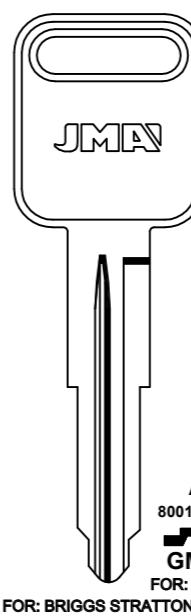

A
8001-9400
GM-2

FOR: G.M.®
FOR: BRIGGS STRATTON®

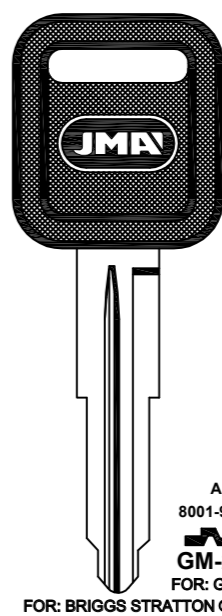

A
8001-9400
GM-2.P

FOR: G.M.®
FOR: BRIGGS STRATTON®

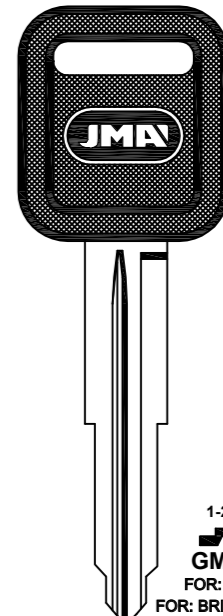

U
1-2000
GM-3.P

FOR: G.M.®
FOR: BRIGGS S.®

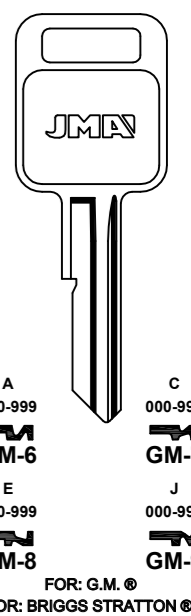

A
000-999
GM-6
E
000-999
GM-8

FOR: G.M.®
FOR: BRIGGS STRATTON®

FOR: G.M. (CHEVROLET)®

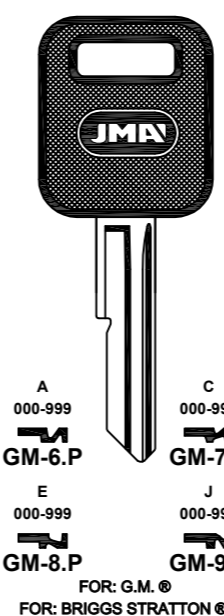

A
000-999
GM-6.P
E
000-999
GM-8.P

FOR: G.M.®
FOR: BRIGGS STRATTON®

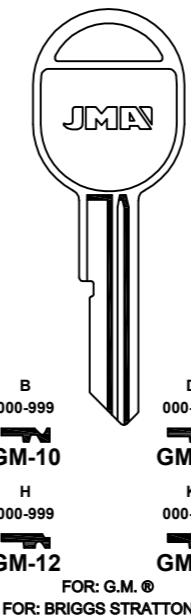

C
000-999
GM-7.P
J
000-999
GM-9.P

FOR: G.M.®
FOR: BRIGGS STRATTON®

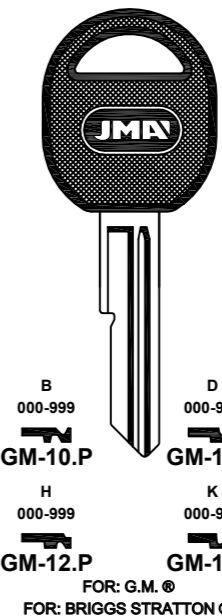

B
000-999
GM-10
H
000-999
GM-12.P

FOR: G.M.®
FOR: BRIGGS STRATTON®

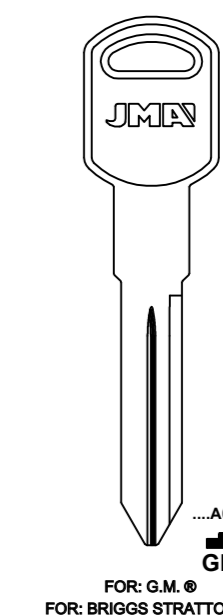

D
000-999
GM-11
K
000-999
GM-13.P

FOR: G.M.®
FOR: BRIGGS STRATTON®

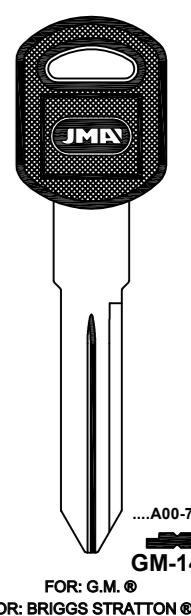

....A00-7N45
GM-14

FOR: G.M.®
FOR: BRIGGS STRATTON®

Concerning the marks and commercial denominations see legal warning.
Concieniente a las marcas y denominaciones comerciales ver aviso legal.
Marka eta izendapen komertzialiei dagokienez, ikus lege-oharra.
Concernant les marques et denominations commerciales voir la note dans l'index.

FOR: G.M. (CHEVROLET)®

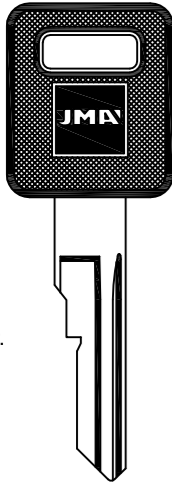

LAT.

A
 ..A.00-99.9
 ..B.00-99.9
 ..V.00-99.9
 ..W.00-99.9
 ..W.00-99.9

C
 ..A.00-99.9
 ..B.00-99.9
 ..N.00-99.9
 ..N.00-99.9
 ..P.00-99.9
 ..P.00-99.9

GM-16.P

E
 ..J.00-99.9
 ..K.00-99.9

GM-18.P

FOR: G.M.®
 FOR: BRIGGS STRATTON®

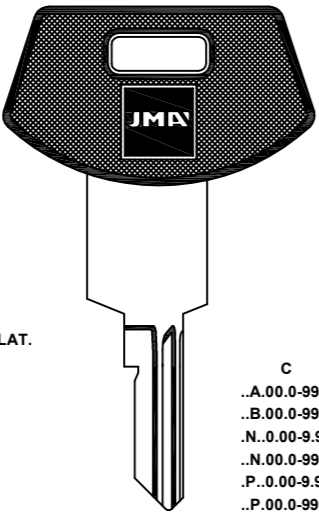

LAT.

C
 ..A.00-99.9
 ..B.00-99.9
 ..N.00-99.9
 ..N.00-99.9
 ..P.00-99.9
 ..P.00-99.9

GM-19.P

E
 ..J.00-99.9
 ..K.00-99.9

GM-20.P

FOR: G.M.®
 FOR: BRIGGS STRATTON®

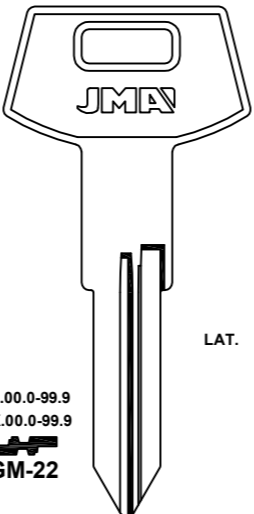

LAT.

..J.00-99.9
 ..K.00-99.9

GM-22

FOR: G.M.®
 FOR: BRIGGS STRATTON®

FOR: G.M. (CHEVROLET)®

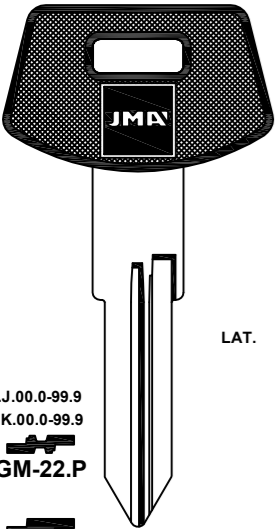

LAT.

..J.00-99.9
 ..K.00-99.9

GM-23.P

FOR: G.M.®
 FOR: BRIGGS STRATTON®

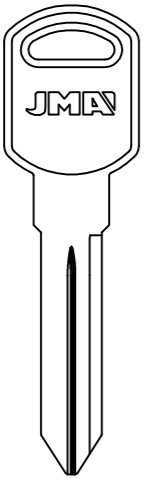

LAT.

....A00-7N45

GM-25

FOR: G.M.®
 FOR: BRIGGS STRATTON®

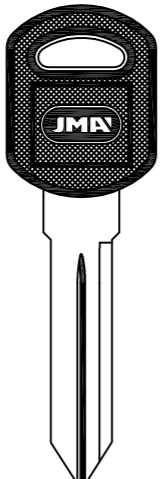

LAT.

....A00-7N45

GM-25.P

FOR: G.M.®
 FOR: BRIGGS STRATTON®

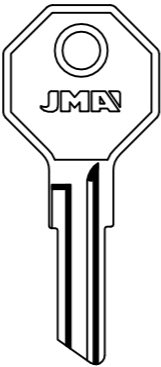

LAT.

GM-26

FOR: G.M.®

A
 000-999

GM-A

C
 000-999

GM-C

E
 000-999

GM-E

J
 000-999

GM-J

FOR: G.M.®
 FOR: BRIGGS STRATTON®

FOR: G.M. (CHEVROLET)®

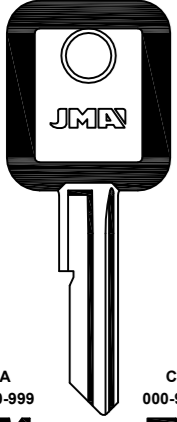

A
 000-999

GM-A.P

C
 000-999

GM-C.P

B
 000-999

GM-B

D
 000-999

GM-D

B
 000-999

GM-B.P

D
 000-999

GM-D.P

H
 001-400
 2221-2620
 4441-4640
 4641-5143

MIT-21

E
 2001-3000

MIT-2D

TOYO-15

FOR: G.M.®
 FOR: BRIGGS STRATTON®

FOR: G.M.®
 FOR: BRIGGS STRATTON®

FOR: G.M.®
 FOR: BRIGGS STRATTON®

FOR: MITSUBISHI®

FOR: TOYOTA®
 FOR: TOKAJ®-RIKA®

FOR: G.M. (CHEVROLET)®

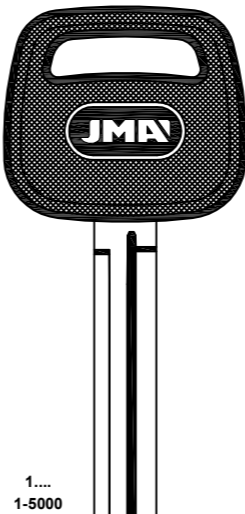

LAT.

1-5000

TOYO-15.P

FOR: TOYOTA®
 FOR: TOKAJ®-RIKA®



LAT.

2.95 7.8

TOYO-18.P

FOR: TOYOTA®
 FOR: TOKAJ®-RIKA®

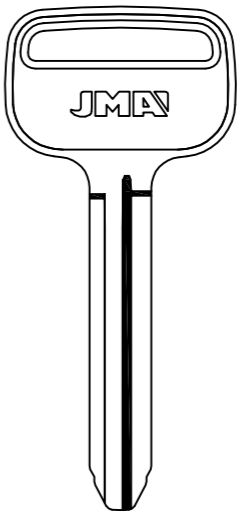

LAT.

TOYO-40

FOR: TOYOTA®



LAT.

TOYO-40D

FOR: TOYOTA®

FOR: G.M. (CHEVROLET BRA.)®

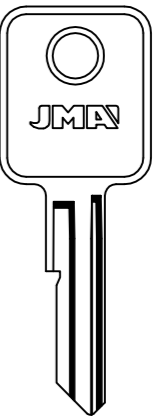

LAT.

E,D
 225-814

K
 0001-1000

BAS-11

FOR: BASCO®
 FOR: CORBIN®

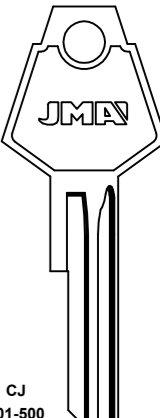

LAT.

CJ
 001-500
 DP
 0001-1400
 EP
 0001-3000

CHR-7

FOR: CHRYSLER®
 FOR: YALE®

DP
 0001-1400
 EP
 0001-3000

BAS-1D
 8000-9499

BAS-1D

FOR: BASCO®
 FOR: CORBIN®

FOR: G.M. (CHEVROLET BRA.)®

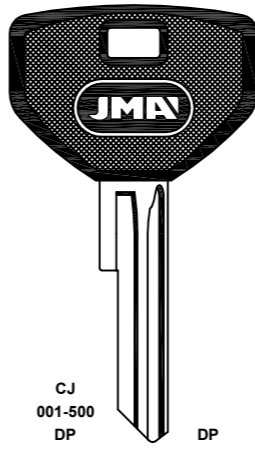

LAT.

CJ
 001-500
 DP
 0001-1400
 EP
 0001-3000

CHR-7.P

FOR: CHRYSLER®
 FOR: YALE®

A
 000-999

GM-6

C
 000-999

GM-7

E
 000-999

GM-8

J
 000-999

GM-9

FOR: G.M.®
 FOR: BRIGGS STRATTON®



LAT.

A
 000-999

GM-6.P

C
 000-999

GM-7.P

E
 000-999

GM-8.P

J
 000-999

GM-9.P

FOR: G.M.®
 FOR: BRIGGS STRATTON®

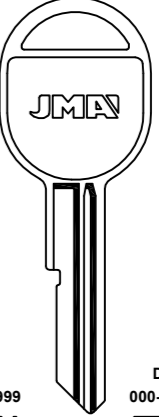

LAT.

B
 000-999

GM-10

D
 000-999

GM-11

H
 000-999

GM-12

K
 000-999

GM-13

FOR: G.M.®
 FOR: BRIGGS STRATTON®



LAT.

B
 000-999

GM-10.P

D
 000-999

GM-11.P

H
 000-999

GM-12.P

K
 000-999

GM-13.P

FOR: G.M.®
 FOR: BRIGGS STRATTON®

FOR: G.M. (CHEVROLET BRA.)®

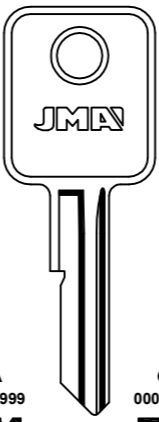

LAT.

A
 000-999

GM-A

C
 000-999

GM-C

E
 000-999

GM-E

J
 000-999

GM-J

FOR: G.M.®
 FOR: BRIGGS STRATTON®

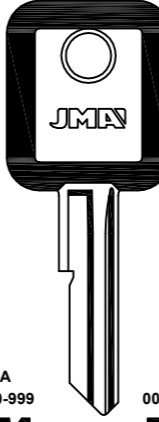

LAT.

A
 000-999

GM-A.P

C
 000-999

GM-C.P

E
 000-999

GM-E.P

J
 000-999

GM-J.P

FOR: G.M.®
 FOR: BRIGGS STRATTON®

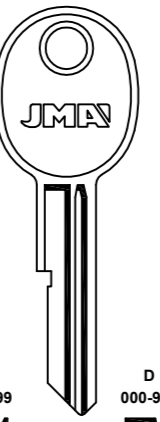

LAT.

B
 000-999

GM-B

D
 000-999

GM-D

H
 000-999

GM-H

K
 000-999

GM-K

FOR: G.M.®
 FOR: BRIGGS STRATTON®

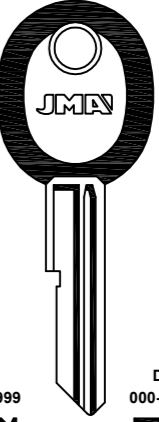

LAT.

B
 000-999

GM-B.P

D
 000-999

GM-D.P

H
 000-999

GM-H.P

K
 000-999

GM-K.P

FOR: G.M.®
 FOR: BRIGGS STRATTON®

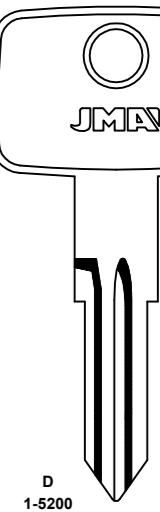

LAT.

D
 1-5200

OP-D

S....
 1-5200

OP-S

FOR: HUF®
 FOR: YMOS®

Concerning the marks and commercial denominations see legal warning.
 Concerniente a las marcas y denominaciones comerciales ver aviso legal.
 Marka eta izendapen komertzialiei dagokienez, ikus lege-oharra.
 Concernant les marques et dénominations commerciales voir la note dans l'index.

FOR: G.M. (CHEVROLET BRA.) ®

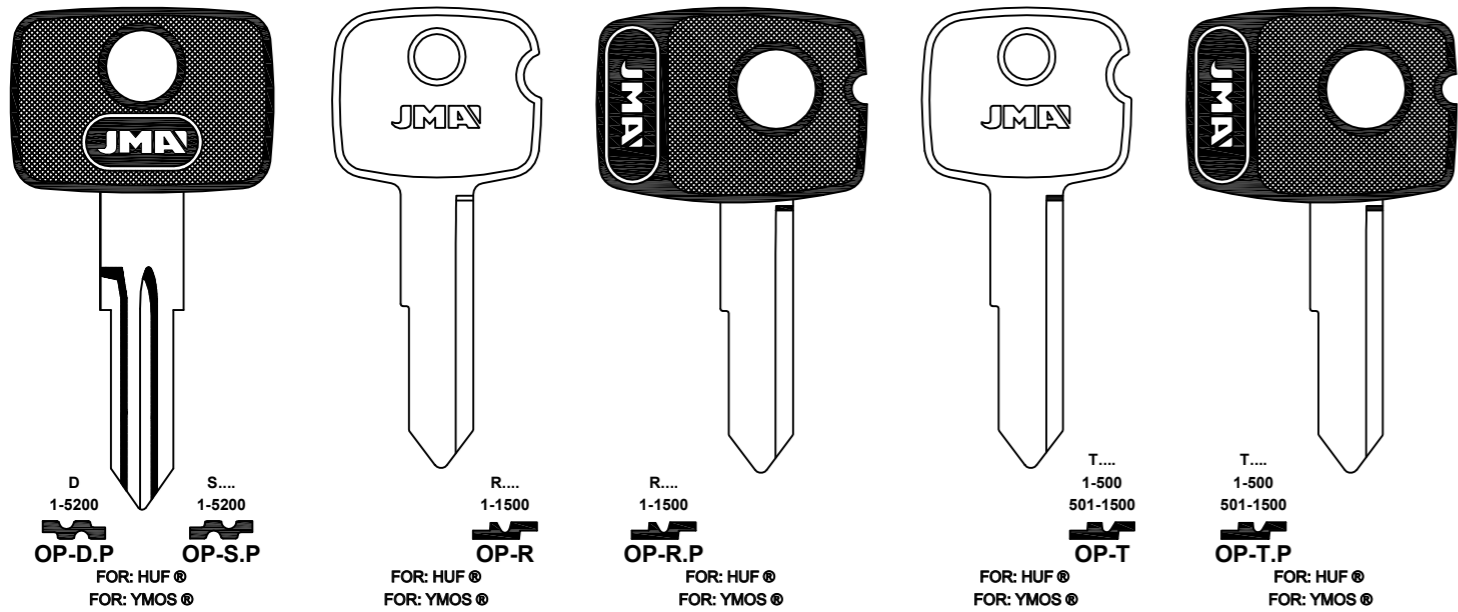

FOR: G.M. (GMC) ®

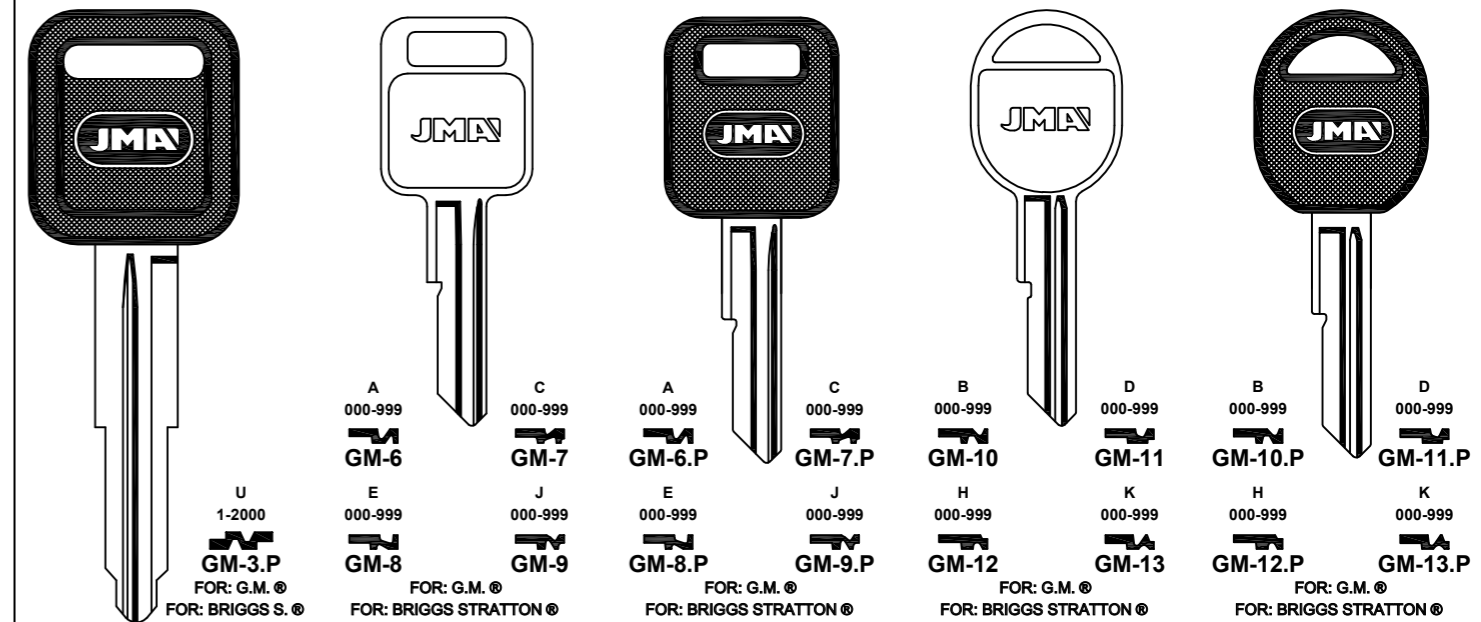

FOR: G.M. (CHEVROLET BRA.) ®

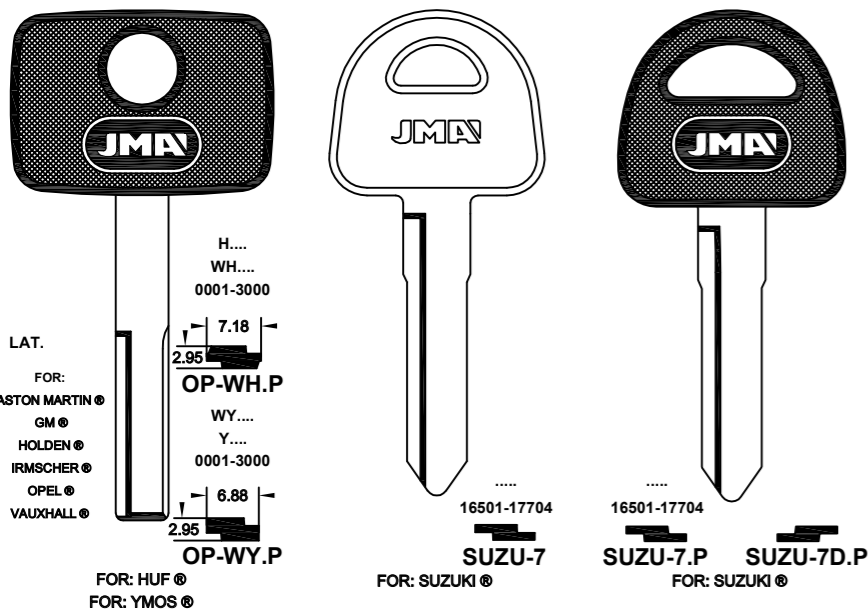

FOR: G.M. (GEO) ®

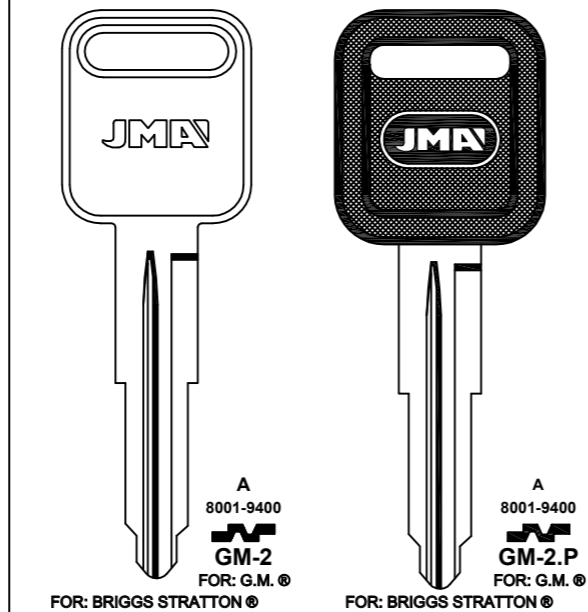

FOR: G.M. (GMC) ®

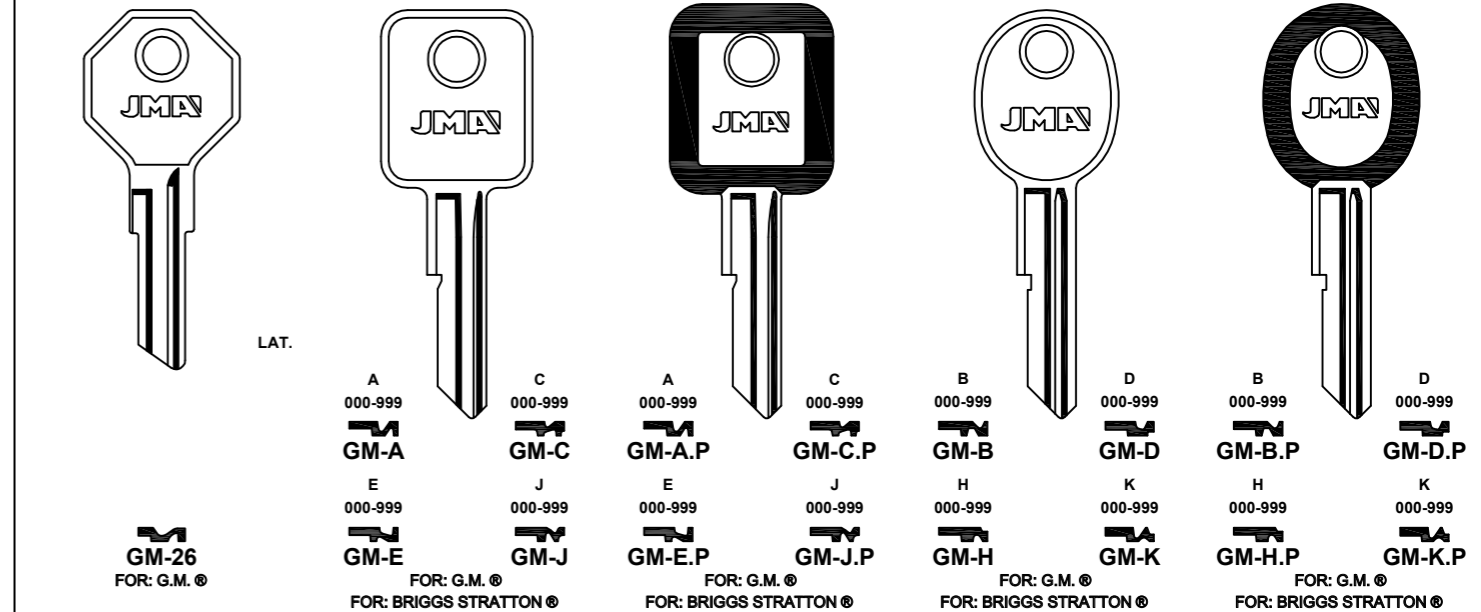

FOR: G.M. (GEO) ®

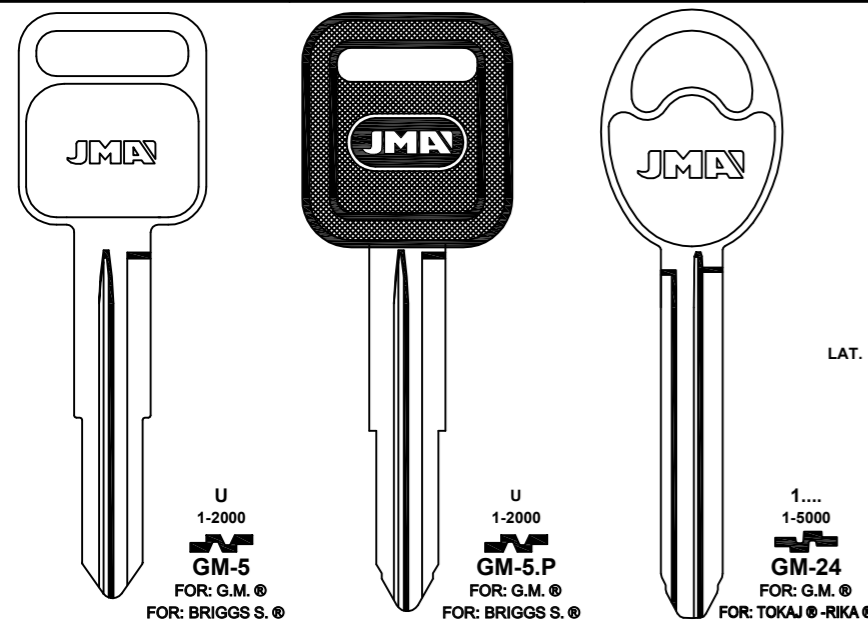

FOR: G.M. (GMC) ®

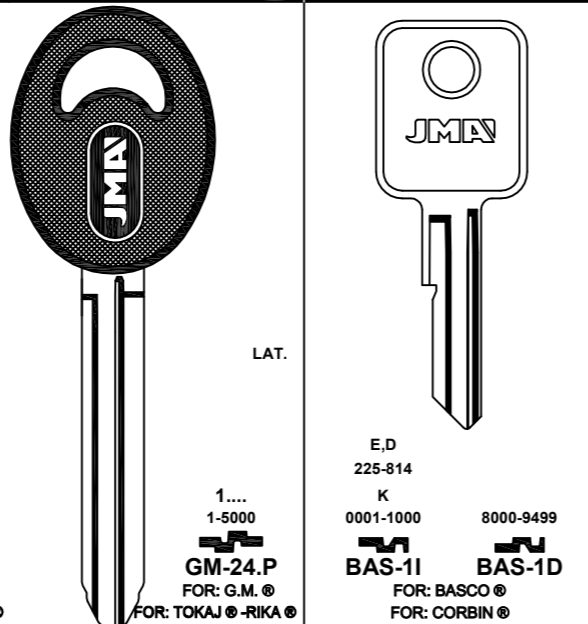

FOR: G.M. (OLDS MOBILE) ®

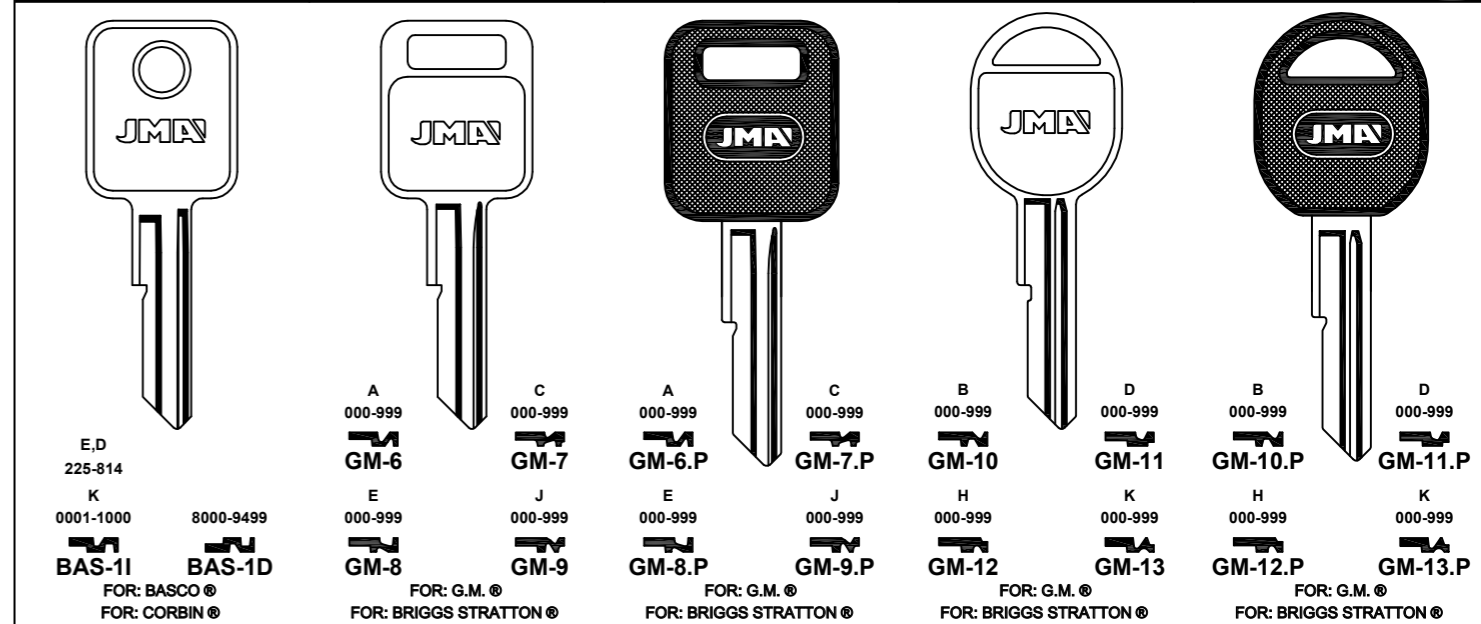

Concerning the marks and commercial denominations see legal warning.
 Concerniente a las marcas y denominaciones comerciales ver aviso legal.
 Marka eta izendapen komertzialiei dagokienez, ikus lege-oharra.
 Concernant les marques et denominations commerciales voir la note dans l'index.

JMA Opening the future

JMA Opening the future

Beziehen auf die marke und handelsname sehen sie die notiz im Impressum.
 Relativamente às marcas e denominações comerciais, ver aviso legal.
 Jeśli chodzi o znaki i nazwy handlowe, patrz Informacje prawne.

FOR: G.M. (OLDS MOBILE) ®

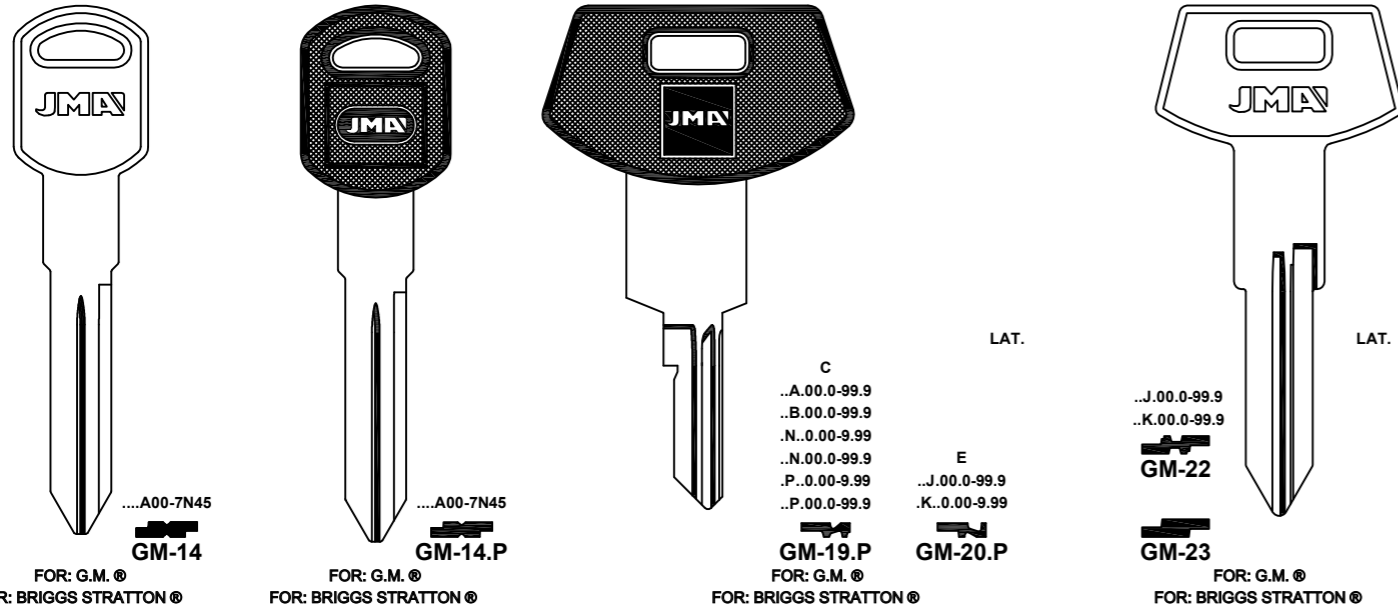

FOR: G.M. (OLDS MOBILE) ®

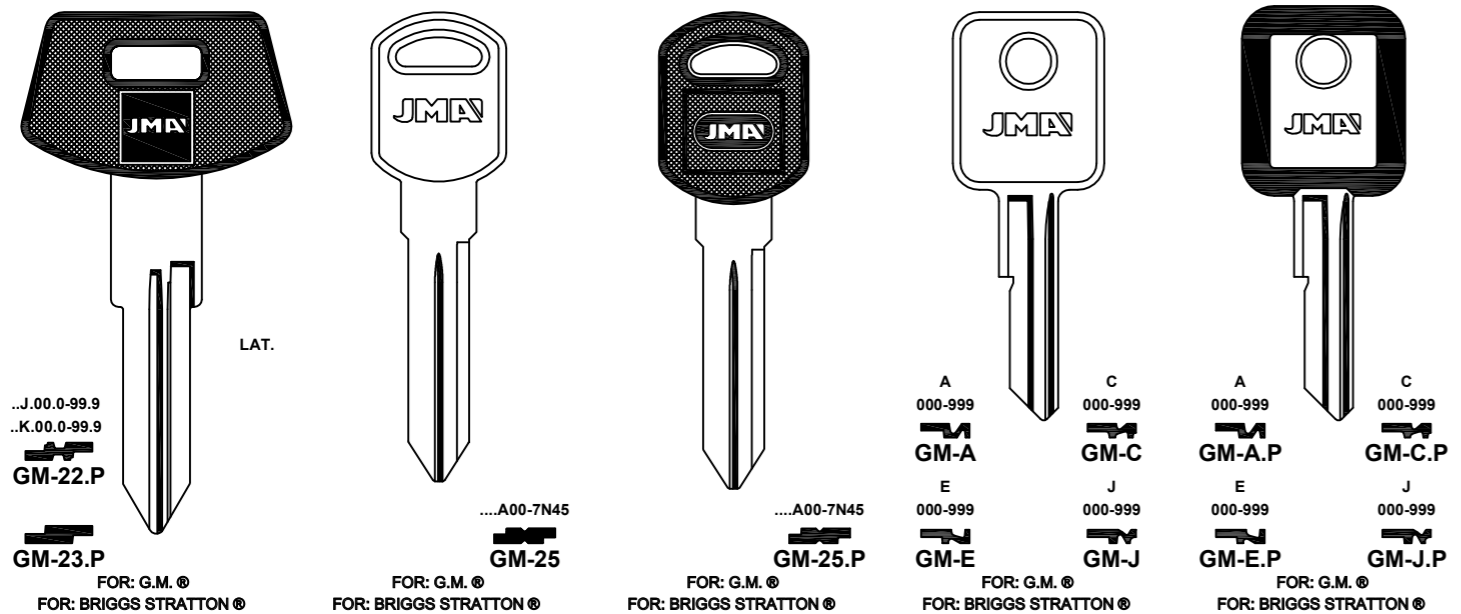

FOR: G.M. (OLDS MOBILE) ®

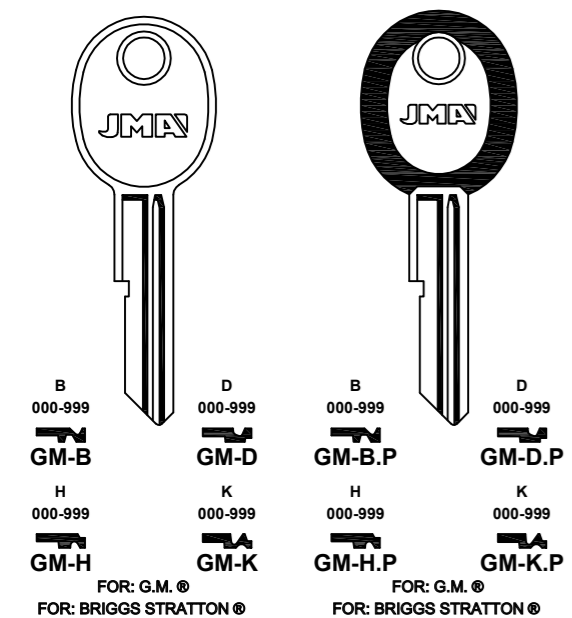

FOR: G.M. (PONTIAC) ®

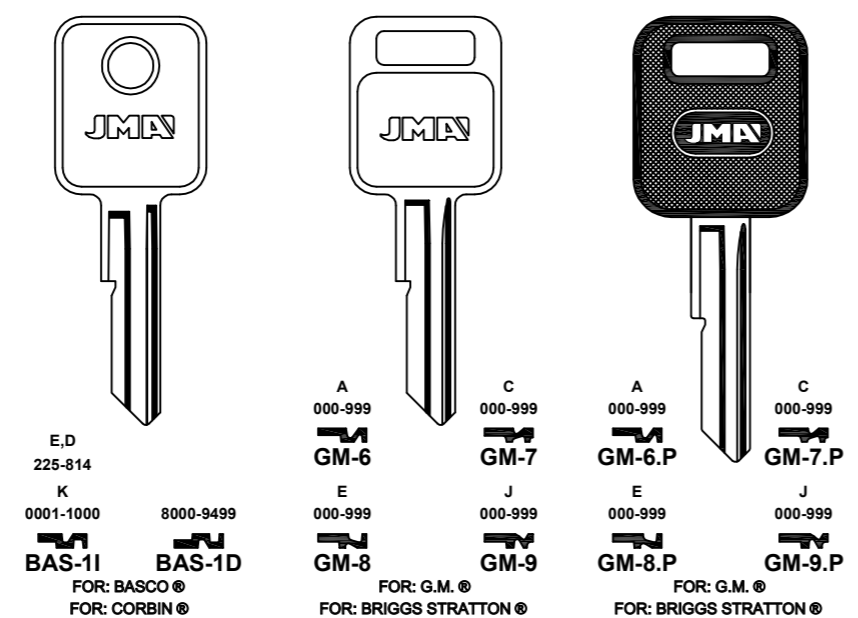

FOR: G.M. (PONTIAC) ®

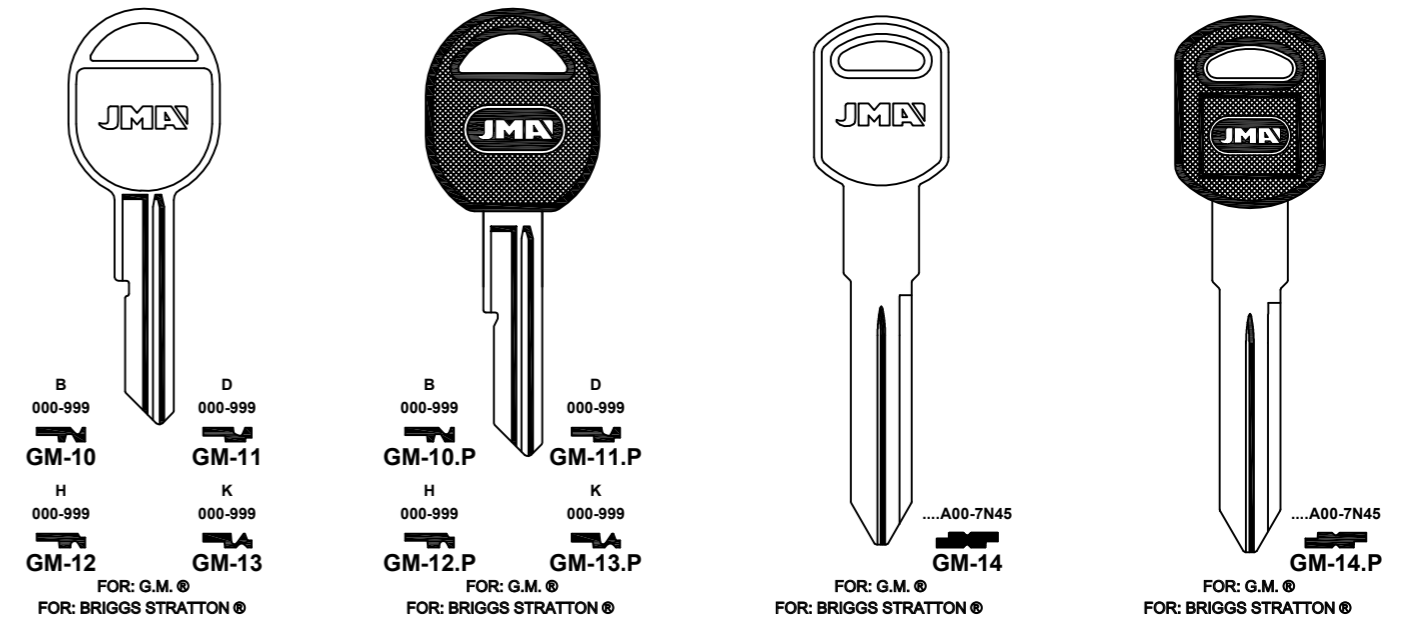

FOR: G.M. (PONTIAC) ®

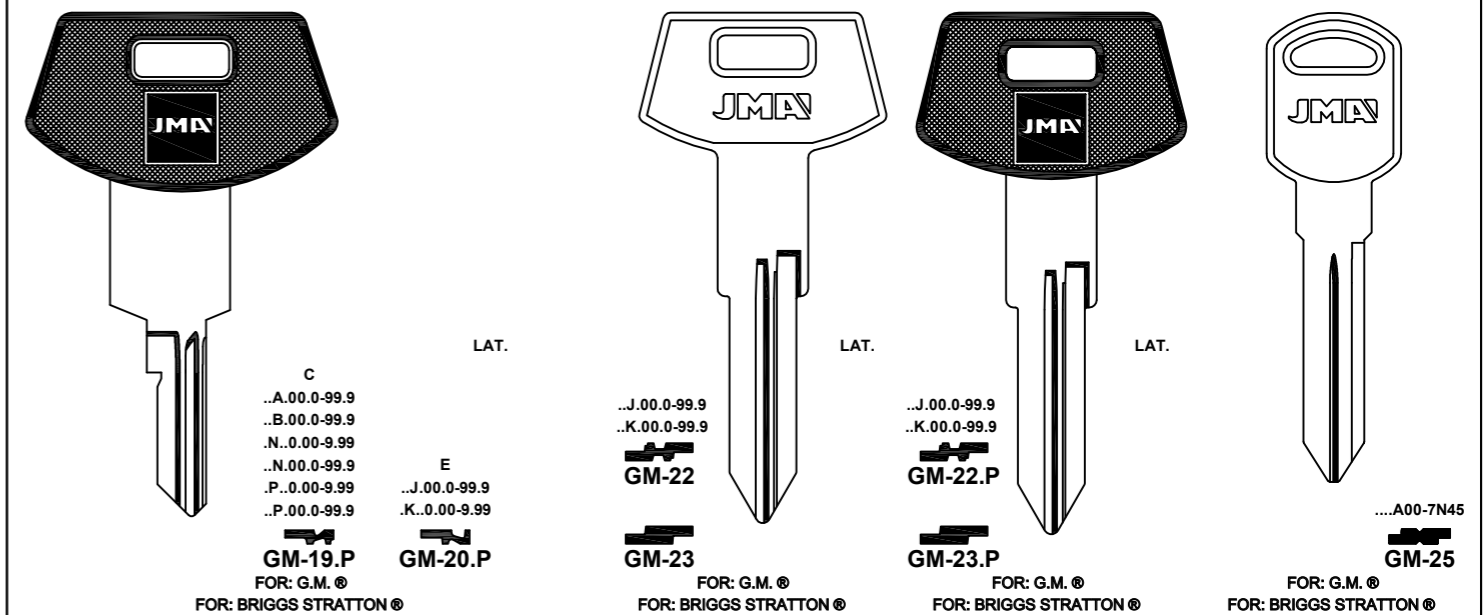

FOR: G.M. (PONTIAC) ®

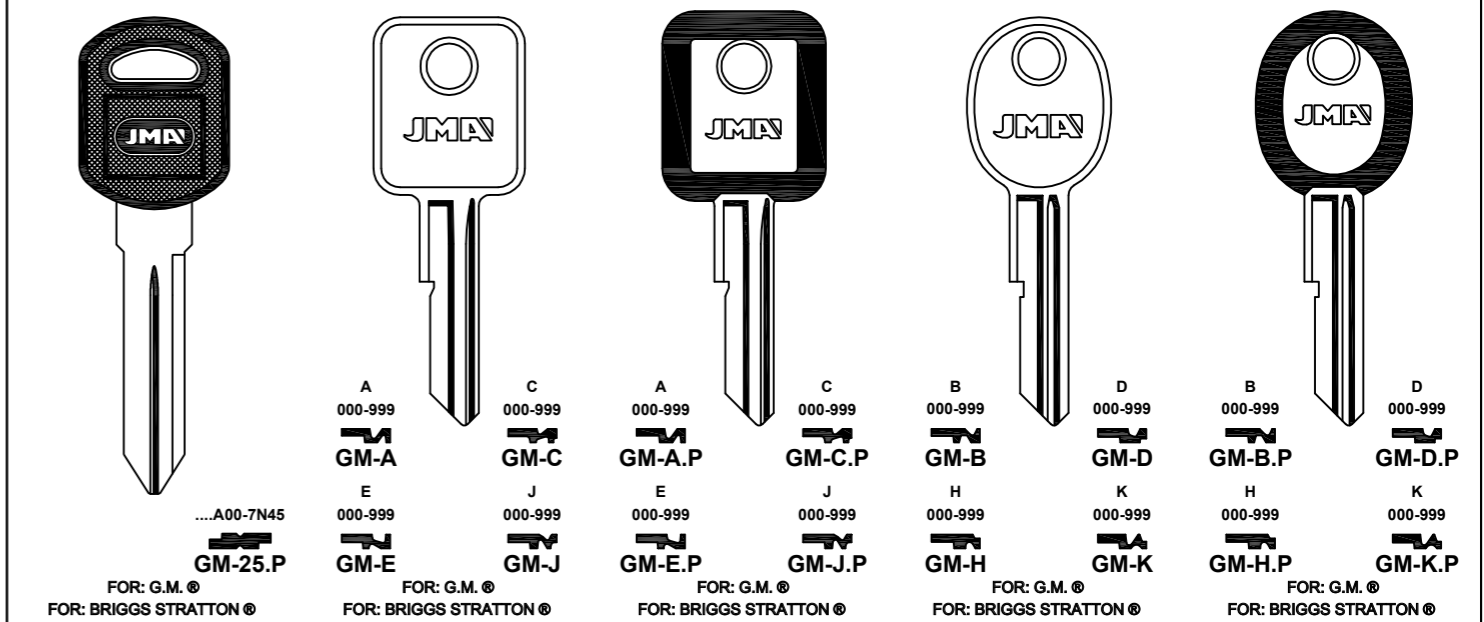

Concerning the marks and commercial denominations see legal warning.
 Concerniente a las marcas y denominaciones comerciales ver aviso legal.
 Marka eta izendapen komertzialiei dagokienez, ikus lege-oharra.
 Concernant les marques et denominations commerciales voir la note dans l'index.

JMA Opening the future

JMA Opening the future

Beziehen auf die Marke und Handelsname sehen sie die Notiz im Impressum.
 Relativamente às marcas e denominações comerciais, ver aviso legal.
 Jeśli chodzi o znaki i nazwy handlowe, patrz Informacje prawne.

FOR: G.M. (PONTIAC)®

D 1-5200
S... 1-5200
OP-D
FOR: HUF®
FOR: YMOS®

D 1-5200
S... 1-5200
OP-D.P
FOR: HUF®
FOR: YMOS®

FOR: G.M. (SATURN)®

R...0-999
T...0-394
GM-21
FOR: G.M.®
FOR: BRIGGS & STRATTON®

LAT.

R...0-999
T...0-394
GM-21.P
FOR: G.M.®
FOR: BRIGGS & STRATTON®

LAT.

FOR: HAMOMAG HENS.®

VA 01-50
ME-VA
FOR: G.M.®
FOR: CASI®

FOR: HOLDEN®

E,D 225-814
K 0001-1000
8000-9499
BAS-11
FOR: BASCO®
FOR: CORBIN®

X 0001-9000
DAT-12
FOR: NISSAN®

A 8001-9400
GM-2
FOR: G.M.®

A 8001-9400
GM-2.P
FOR: G.M.®

A 000-999
GM-6
FOR: G.M.®

C 000-999
GM-7
FOR: G.M.®

E 000-999
GM-8
FOR: G.M.®

J 000-999
GM-9
FOR: G.M.®

FOR: HOLDEN®

A 000-999
GM-6.P
FOR: G.M.®
FOR: BRIGGS STRATTON®

C 000-999
GM-7.P
FOR: G.M.®
FOR: BRIGGS STRATTON®

B 000-999
GM-10
FOR: G.M.®
FOR: BRIGGS STRATTON®

D 000-999
GM-11
FOR: G.M.®
FOR: BRIGGS STRATTON®

B 000-999
GM-10.P
FOR: G.M.®
FOR: BRIGGS STRATTON®

D 000-999
GM-11.P
FOR: G.M.®
FOR: BRIGGS STRATTON®

H 000-999
GM-12
FOR: G.M.®
FOR: BRIGGS STRATTON®

K 000-999
GM-13
FOR: G.M.®
FOR: BRIGGS STRATTON®

H 000-999
GM-12.P
FOR: G.M.®
FOR: BRIGGS STRATTON®

K 000-999
GM-13.P
FOR: G.M.®
FOR: BRIGGS STRATTON®

0000-1999
GM-42
FOR: G.M.®

A 000-999
GM-A
FOR: G.M.®
FOR: BRIGGS STRATTON®

C 000-999
GM-C
FOR: G.M.®
FOR: BRIGGS STRATTON®

E 000-999
GM-E
FOR: G.M.®
FOR: BRIGGS STRATTON®

J 000-999
GM-J
FOR: G.M.®
FOR: BRIGGS STRATTON®

FOR: HOLDEN®

A 000-999
GM-A.P
FOR: G.M.®
FOR: BRIGGS STRATTON®

C 000-999
GM-C.P
FOR: G.M.®
FOR: BRIGGS STRATTON®

B 000-999
GM-B
FOR: G.M.®
FOR: BRIGGS STRATTON®

D 000-999
GM-D
FOR: G.M.®
FOR: BRIGGS STRATTON®

B 000-999
GM-B.P
FOR: G.M.®
FOR: BRIGGS STRATTON®

D 000-999
GM-D.P
FOR: G.M.®
FOR: BRIGGS STRATTON®

E 000-999
GM-E.P
FOR: G.M.®
FOR: BRIGGS STRATTON®

J 000-999
GM-J.P
FOR: G.M.®
FOR: BRIGGS STRATTON®

H 000-999
GM-H
FOR: G.M.®
FOR: BRIGGS STRATTON®

K 000-999
GM-K
FOR: G.M.®
FOR: BRIGGS STRATTON®

H 000-999
GM-H.P
FOR: G.M.®
FOR: BRIGGS STRATTON®

K 000-999
GM-K.P
FOR: G.M.®
FOR: BRIGGS STRATTON®

A...201-1050
C...500-699
H...601-1100
HM...201-1050
HUD-1
FOR: HUDSON®

H 001-400
2221-2620
4441-4640
4641-5143
E 2001-3000
MIT-1I
FOR: MITSUBISHI®

H 001-400
2221-2620
4441-4640
4641-5143
E 2001-3000
MIT-1D
FOR: MITSUBISHI®

FOR: HOLDEN®

H 001-400
2221-2620
4441-4640
4641-5143
E 2001-3000
MIT-1I.P
FOR: MITSUBISHI®

H 001-400
2221-2620
4441-4640
4641-5143
E 2001-3000
MIT-1D.P
FOR: MITSUBISHI®

AB... 1-1000
OP-AB
FOR: HUF®
FOR: YMOS®

BA... 1-1000
OP-BA
FOR: HUF®
FOR: YMOS®

AB... 1-1000
OP-AB.P
FOR: HUF®
FOR: YMOS®

BA... 1-1000
OP-BA.P
FOR: HUF®
FOR: YMOS®

D 1-5200
OP-D
FOR: HUF®
FOR: YMOS®

S... 1-5200
OP-S
FOR: HUF®
FOR: YMOS®

D 1-5200
OP-D.P
FOR: HUF®
FOR: YMOS®

S... 1-5200
OP-S.P
FOR: HUF®
FOR: YMOS®

FOR: HOLDEN®

J... 1-2874
OP-J
FOR: HUF®
FOR: YMOS®

J... 1-2874
OP-J.P
FOR: HUF®
FOR: YMOS®

H... WH... 0001-3000
OP-WH.P
FOR: ASTON MARTIN®
GM®
HOLDEN®
IRMSCHER®
OPEL®
VAUXHALL®

WY... Y... 0001-3000
OP-WY.P
FOR: HUF®
FOR: YMOS®

U... 1-2000
SUZU-10
FOR: SUZUKI®

U... 1-2000
SUZU-10.P
FOR: SUZUKI®

Concerning the marks and commercial denominations see legal warning.
 Concerniente a las marcas y denominaciones comerciales ver aviso legal.
 Marka eta izendapen komertzialiei dagokienez, ikus lege-oharra.
 Concernant les marques et denominations commerciales voir la note dans l'index.

JMA® Opening the future

JMA® Opening the future

Beziehen auf die Marke und Handelsname sehen sie die Notiz im Impressum.
 Relativamente às marcas e denominações comerciais, ver aviso legal.
 Jeśli chodzi o znaki i nazwy handlowe, patrz Informacje prawne.

FOR: HONDA®

K...
001-400/1511-1910
2221-2620/3731-4570
5001-6368

R...
401-800/1112-1510
2621-3020/3331-3730
5001-6924/8001-9368

S...
5951-6350/7061-7460
8171-8570/9281-9680

D...
6001-7042

TOYO-K1
FOR: TOYOTA®
FOR: TOKAJ® -RIKA®

F...
5951-6350
7061-7460
8171-8570
9281-9680

P...
7001-8500

TOYO-4

K...
001-400/1511-1910
2221-2620/3731-4570
5001-6368

R...
401-800/1112-1510
2621-3020/3331-3730
5001-6924/8001-9368

S...
5951-6350/7061-7460
8171-8570/9281-9680

D...
6001-7042

TOYO-K1.P
FOR: TOYOTA®
FOR: TOKAJ® -RIKA®

F...
5951-6350
7061-7460
8171-8570
9281-9680

P...
7001-8500

TOYO-14.P

FK...
01-99
876-955

UN-FK
FOR: UNION®
FOR: WBH®

FS...
01-99
876-955

UN-FS

FOR: HONDA®

U
1-2000
GM-5.P
FOR: G.M.®
FOR: BRIGGS S.®

001-700
HOND-1
FOR: HONDA®

001-700
HOND-2
FOR: HONDA®

001-700
HOND-2.P
FOR: HONDA®

1 AL 4
HOND-3I **HOND-3D**
FOR: HONDA®

3001-4481
HOND-10
FOR: HONDA®

3001-4481
HOND-11
FOR: HONDA®

FOR: HONDA®

3001-4481
HOND-10.P
FOR: HONDA®

1...
001-700
HOND-12
FOR: HONDA®

2...
001-700
HOND-13
FOR: HONDA®

1...
001-700
HOND-12.P
FOR: HONDA®

2...
001-700
HOND-13.P
FOR: HONDA®

5001-8442
HOND-14
FOR: HONDA®

5001-8442
HOND-14.P
FOR: HONDA®

FOR: HONDA®

5001-8442
HOND-15
FOR: HONDA®

5001-8442
HOND-15.P
FOR: HONDA®

5001-8442
HOND-16
FOR: HONDA®

5001-8442
HOND-16D
FOR: HONDA®

...2001-4949
GM
...2001-3000
NE-1
FOR: NEIMAN®
FOR: CLAUSOR®

...2001-4949
GM
...2001-3000
NE-1D
FOR: NEIMAN®
FOR: CLAUSOR®

FOR: AUDI®
FOR: HONDA®
FOR: MG®
FOR: ROVER®
FOR: BEDFORD®
FOR: FIAT/VECO®
FOR: VOLVO®

FOR: HONDA®

...2001-4949
GM
...2001-3000
NE-1.P
FOR: NEIMAN®
FOR: CLAUSOR®

FOR:
AUDI®
HONDA®
MG®
ROVER®
BEDFORD®
FIAT/VECO®
VOLVO®

R...
E...
4001-5000
S...
8001-10000
NE-1D.P
FOR: NEIMAN®

R...
E...
4001-5000
S...
8001-10000
NE-35
FOR: NEIMAN®

FOR: HUMMER®

A...
101-125
501-598
701-790
BL-2

B...
201-225
BL-3

A
BL-4

B
BL-4D

A 201-225 **B 101-125**
BL-6 **BL-6D**

FOR: BLAU®
FOR: FORT® -HK® -WASO®

RE-1 **RE-1D**
FOR: RENZ®
FOR: ARFE®

FOR: HYUNDAI®

A/Z... 0111-0333
HY-1
FOR: HYUNDAI®

Y
1001-2000
HY-2
FOR: HYUNDAI®

Y
1001-2000
HY-2.P
FOR: HYUNDAI®

Y
1001-2000
HY-3
FOR: HYUNDAI®

X
1001-2000
HY-3D
FOR: HYUNDAI®

Concerning the marks and commercial denominations see legal warning.
Concerniente a las marcas y denominaciones comerciales ver aviso legal.
Marka eta izendapen komertzialiei dagokienez, ikus lege-oharra.
Concernant les marques et dénominations commerciales voir la note dans l'index.

JMA Opening the future

JMA Opening the future

Beziehen auf die marke und handelsname sehen sie die notiz im Impressum.
Relativamente às marcas e denominações comerciais, ver aviso legal.
Jeśli chodzi o znaki i nazwy handlowe, patrz Informacje prawne.

FOR: HYUNDAI®

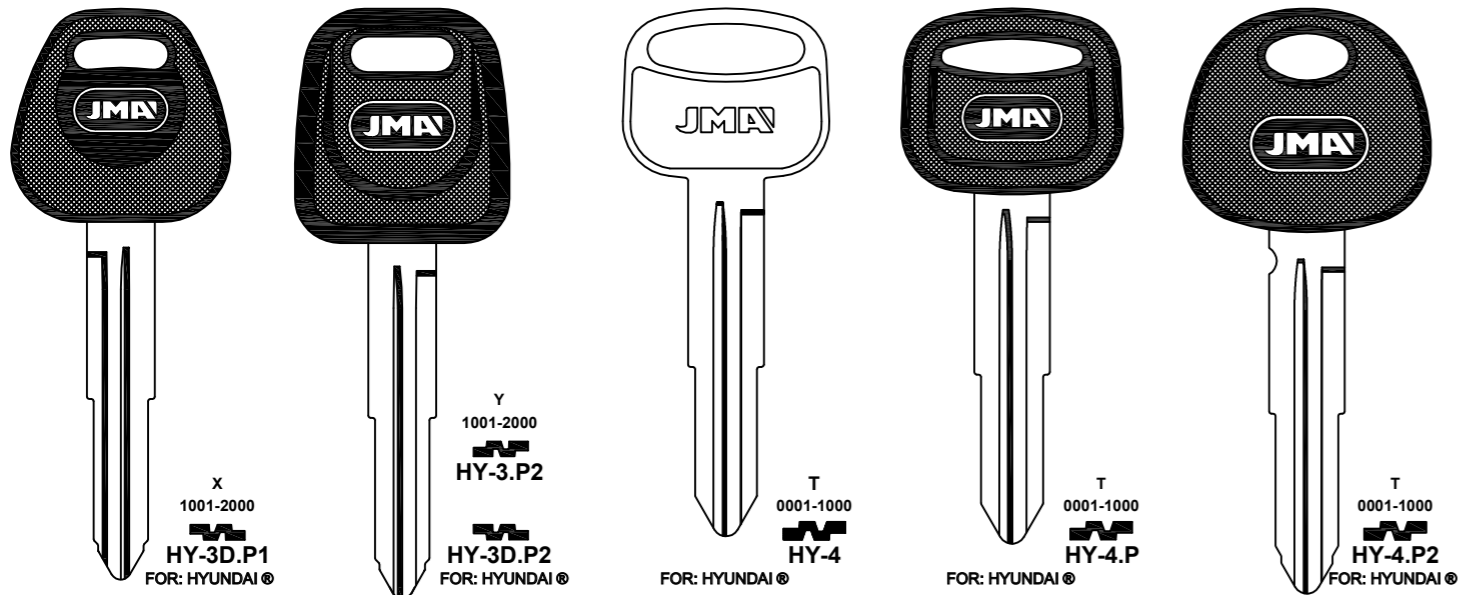

FOR: HYUNDAI®

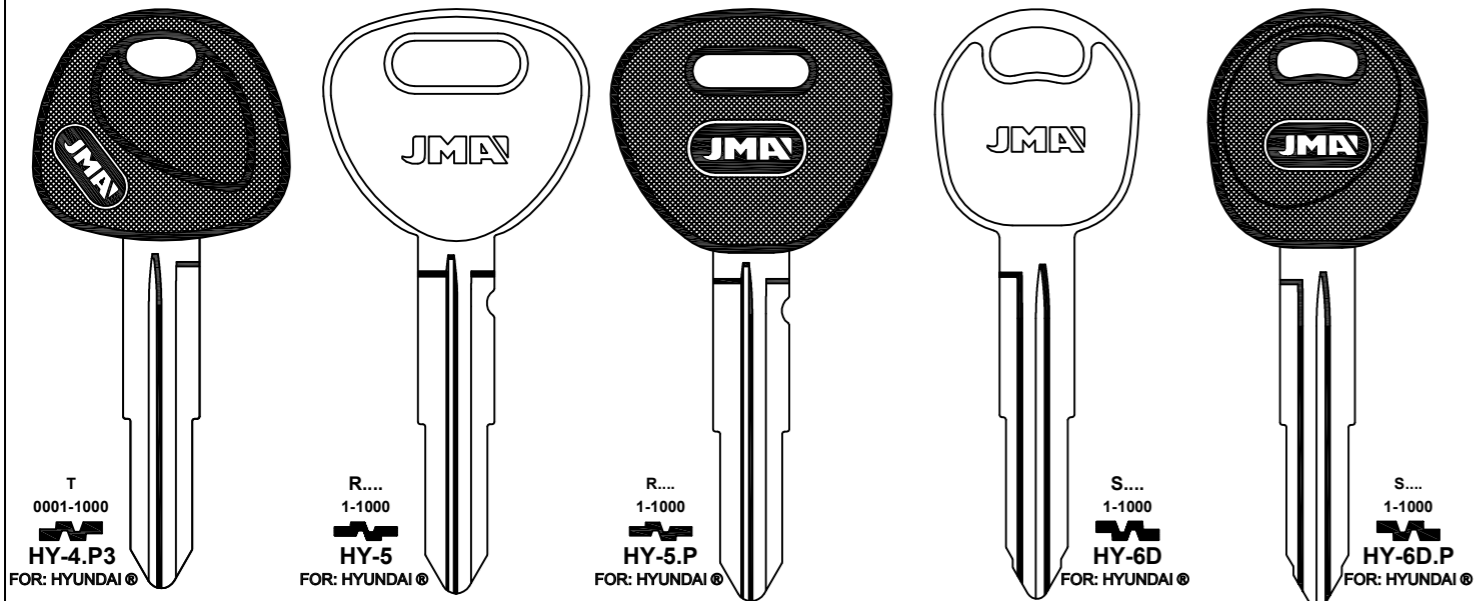

FOR: HYUNDAI®

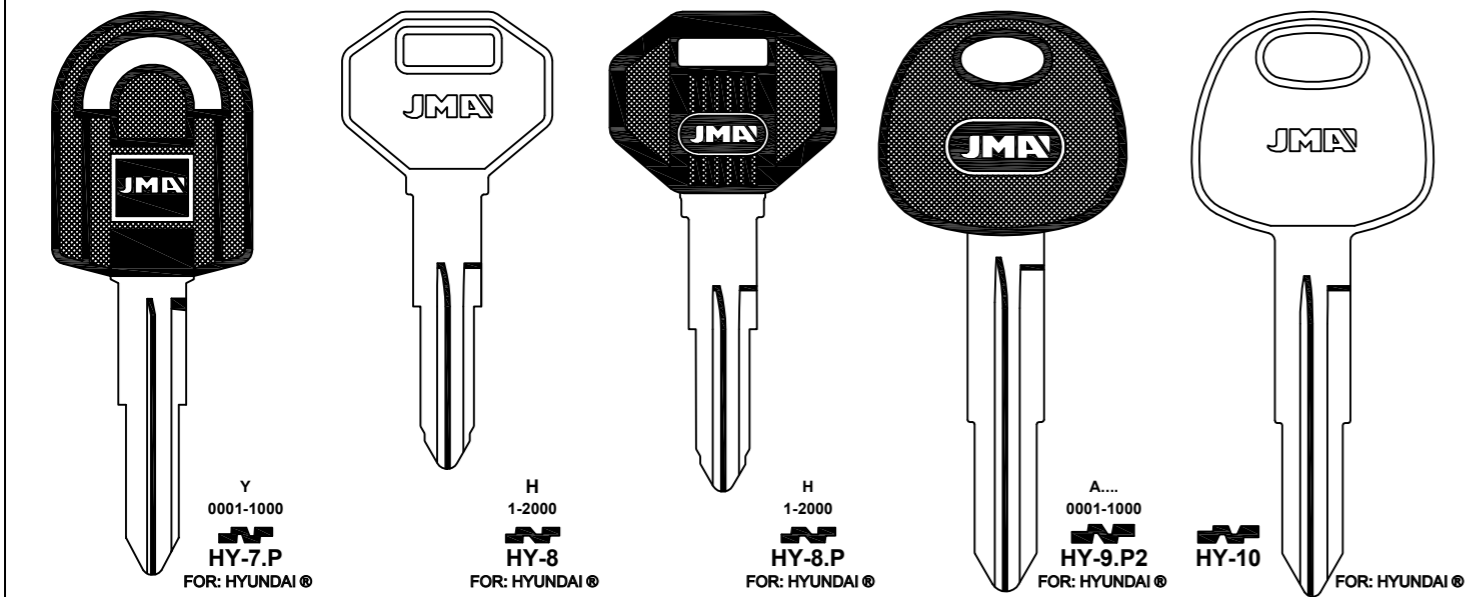

FOR: HYUNDAI®

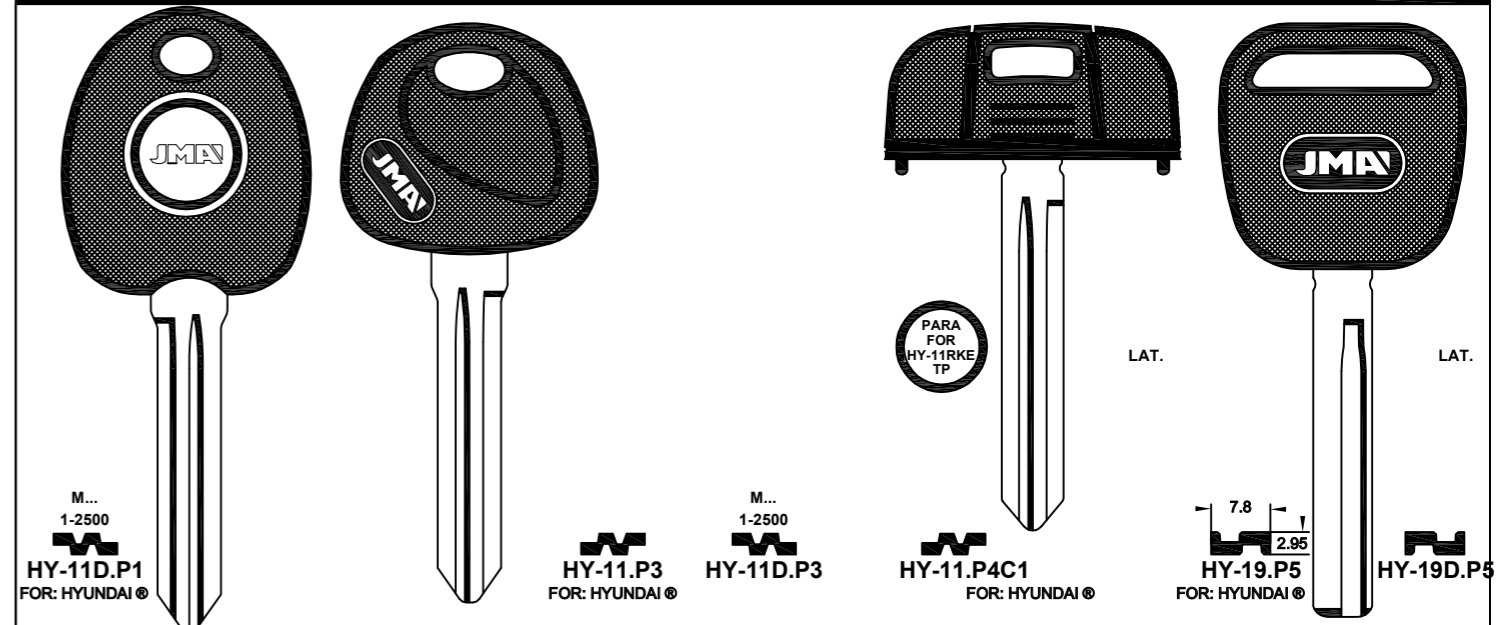

FOR: HYUNDAI®

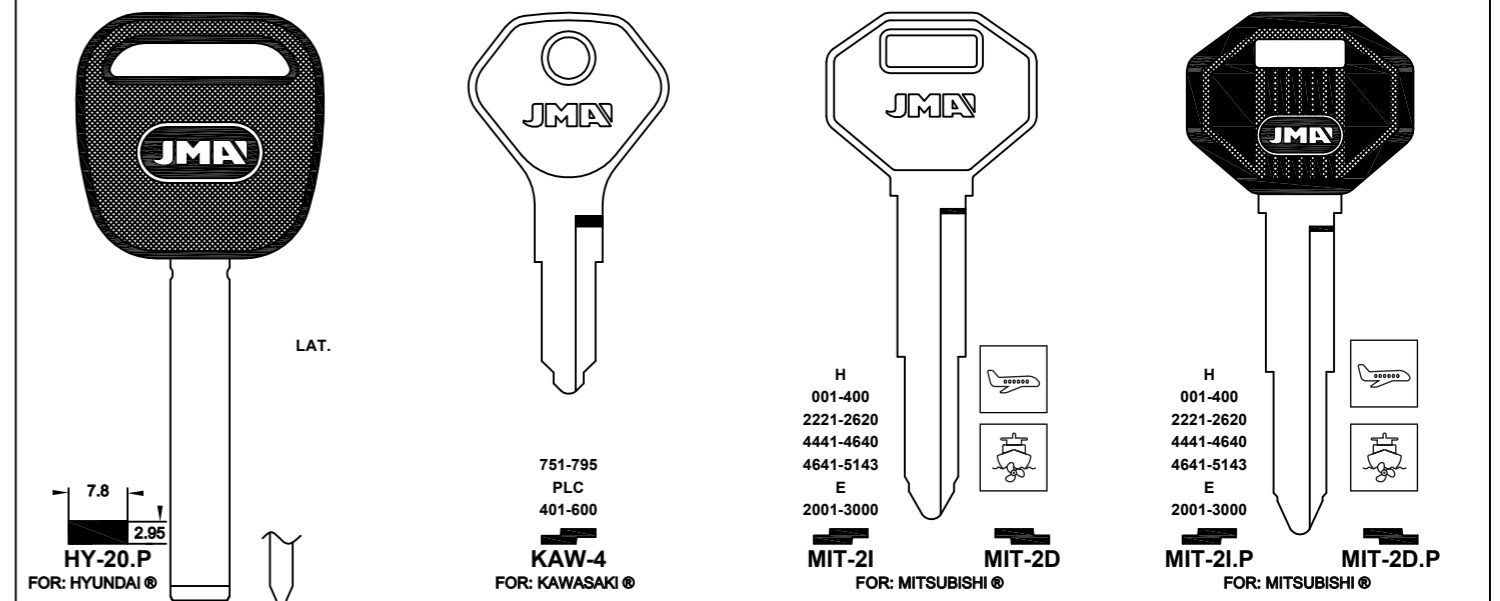

FOR: HYUNDAI®

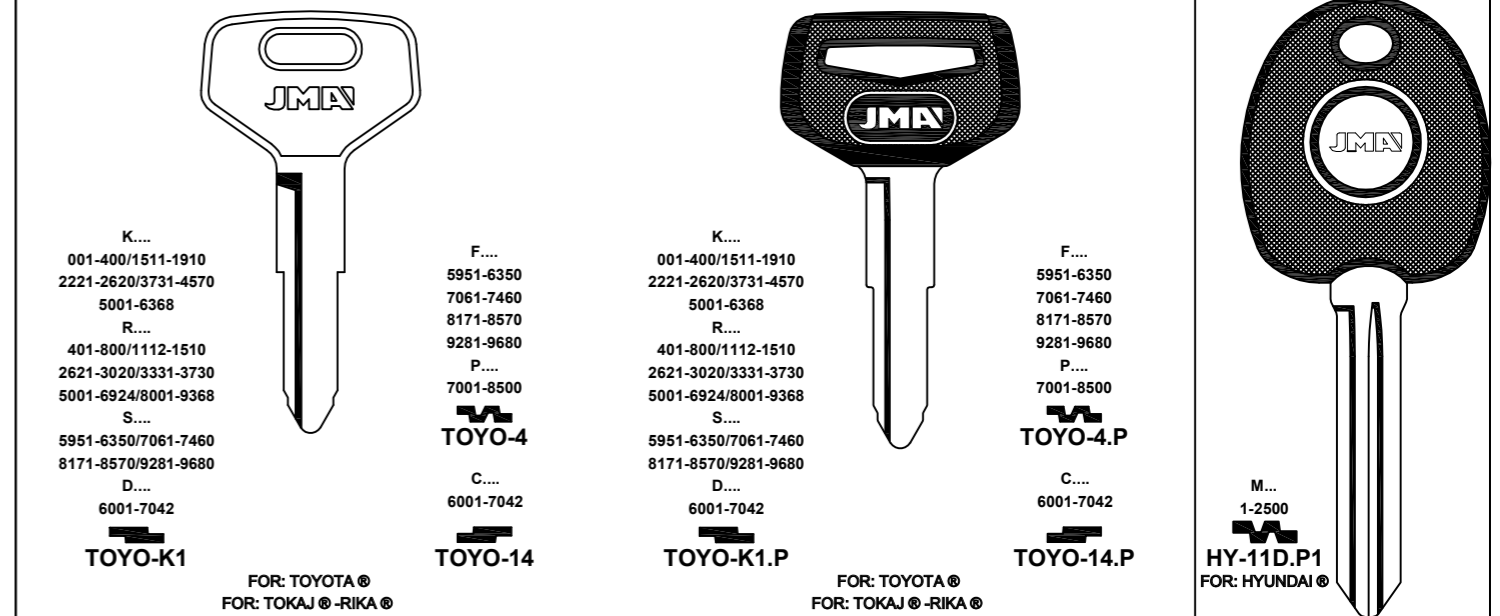

FOR: HYUNDAI(CANAD.)®

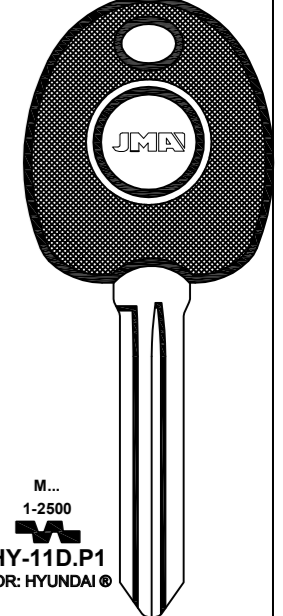

Concerning the marks and commercial denominations see legal warning.
 Concerniente a las marcas y denominaciones comerciales ver aviso legal.
 Marka eta izendapen komertzialiei dagokienez, ikus lege-oharra.
 Concernant les marques et denominations commerciales voir la note dans l'index.

JMA® Opening the future

JMA® Opening the future

Beziehen auf die marke und handelsname sehen sie die notiz im Impressum.
 Relativamente às marcas e denominações comerciais, ver aviso legal.
 Jeśli chodzi o znaki i nazwy handlowe, patrz Informacje prawne.

FOR: HYUNDAI (USA) ®

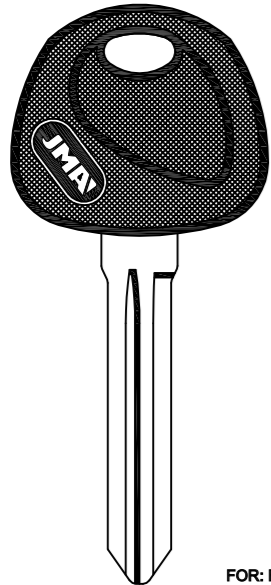

HY-11.P3
FOR: HYUNDAI ®
M...
1-2500
HY-11D.P3

FOR: INFINITI (NISSAN) ®

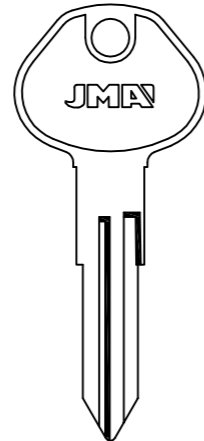

X
0001-8000
DAT-6
DAT-6D
Y
0001-8000
8001-9000
DAT-7
FOR: NISSAN ®
FOR: DATSUN ®

FOR: INNOCENTI ®

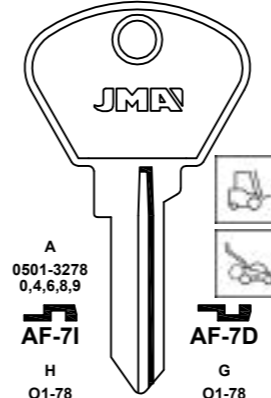

A
0501-3278
0,4,6,8,9
AF-7I
AF-7D
H
01-78
AF-8I
AF-9I
FOR: SIPEA ®
FOR: SAFE ®

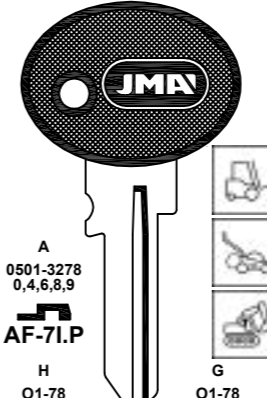

A
0501-3278
0,4,6,8,9
AF-7I.P
H
01-78
AF-8I.P
F
01-78
AF-9I.P
G
01-78
AF-8D
AF-8D.P
E
01-78
AF-9D.P
FOR: SIPEA ®
FOR: SAFE ®

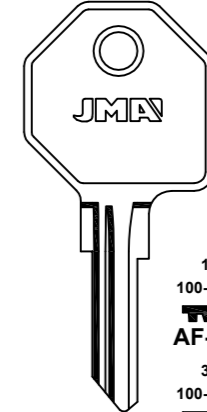

1
100-789
AF-10
3
100-789
AF-11
5
100-789
AF-12
FOR: SAFE ®

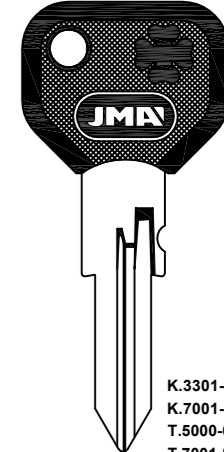

K.3301-4886
K.7001-8092
T.5000-6027
T.7001-8092
S.0501-3278
H.7001-8092
K-H
7001-8092
AF-14.P
FOR: GIOBERT ®
FOR: FIAT ®-M.MARELLI ®-NEIMAN ®-SIPEA ®
FI-6I.P4

FOR: INFINITI (NISSAN) ®

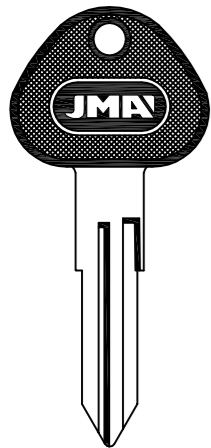

X
0001-8000
DAT-6.P
DAT-6D.P
Y
0001-8000
8001-9000
DAT-7.P
FOR: NISSAN ®
FOR: DATSUN ®

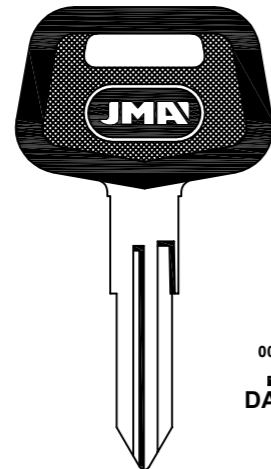

X
0001-8000
DAT-6.P1
DAT-6D.P1
Y
0001-8000
8001-9000
DAT-7.P1
FOR: NISSAN ®
FOR: DATSUN ®

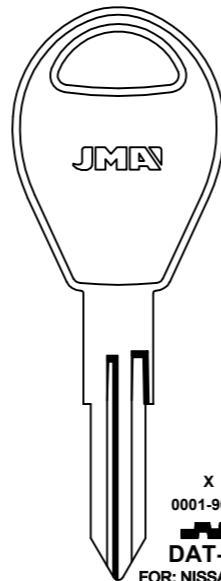

X
0001-9000
DAT-10
FOR: NISSAN ®

FOR: INNOCENTI ®

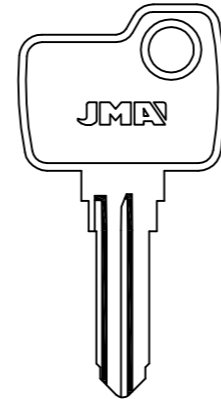

6
100-517
FAR-1I
2
100-517
FAR-2I
H
100-309
FAR-3
FOR: FARMA ®
FOR: FISAM ®

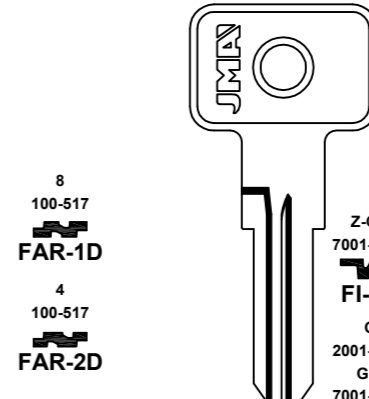

8
100-517
FAR-1D
4
100-517
FAR-2D
H
100-309
FAR-3D
FAR-4D
Z-GR
7001-9956
FI-2D
G
2001-4530
G-Z
7001-9956
FI-3D
G
7001-9956
FI-12
FOR: GIOBERT ®

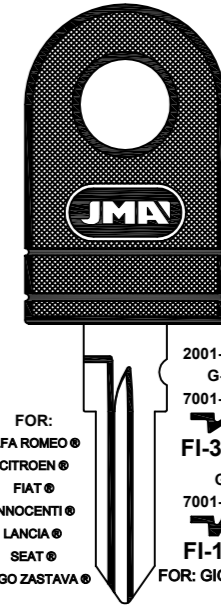

G
2001-4530
G-Z
7001-9956
FI-3D.P
G
7001-9956
FI-12.P
FOR: GIOBERT ®

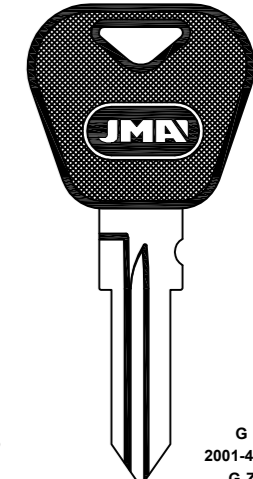

G
2001-4530
G-Z
7001-9956
FI-3D.P5
FOR: GIOBERT ®

FOR: INFINITI (NISSAN) ®

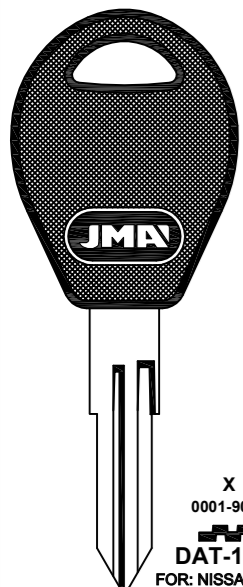

X
0001-9000
DAT-10.P
FOR: NISSAN ®

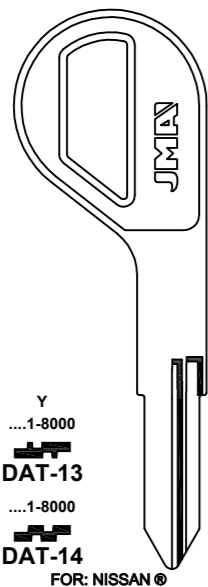

Y
....1-8000
DAT-13
....1-8000
DAT-14
FOR: NISSAN ®

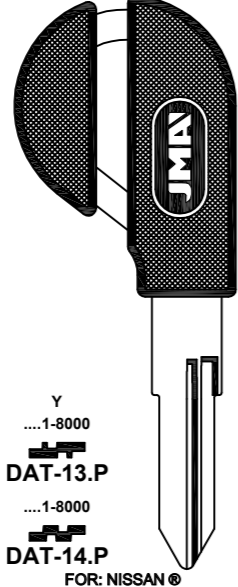

Y
....1-8000
DAT-13.P
....1-8000
DAT-14.P
FOR: NISSAN ®

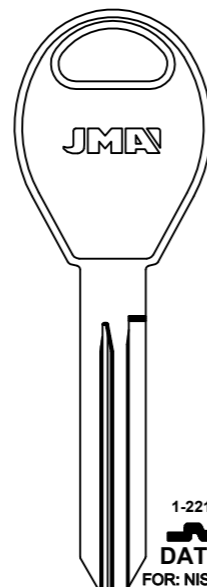

1-22185
DAT-16
FOR: NISSAN ®

FOR: INNOCENTI ®

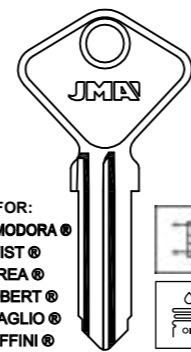

FOR:
CROMODORA ®
FIST ®
FREA ®
GIOBERT ®
MIRAGLIO ®
RUFFINI ®
6
100-309
AF-5I
2
100-309
AF-6I
FOR: SAFE ®

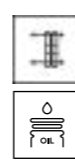

8
100-309
AF-5D
4
100-309
AF-6D

FOR: INNOCENTI ®

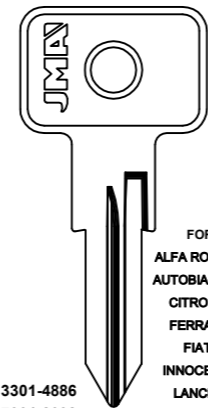

K 3301-4886
K 7001-8092
T 5000-6027
T 7001-8092
S 0501-3278
H 7001-8092
FI-6I
FOR: GIOBERT ®

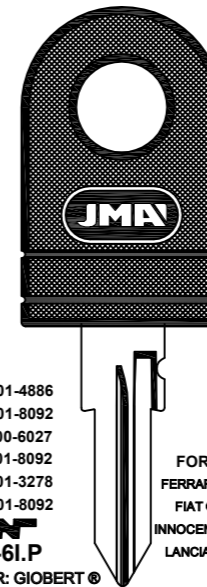

FOR:
ALFA ROMEO ®
AUTOBIANCHI ®
CITROEN ®
FERRARI ®
FIAT ®
INNOCENTI ®
LANCIA ®
PEUGEOT ®
YUGO ZASTAVA ®
CAGIVA ®
DUCATI ®
FANTIC MOTOR ®
GARELLI ®
GILERA ®
K 3301-4886
K 7001-8092
T 5000-6027
T 7001-8092
S 0501-3278
H 7001-8092
FI-6I.P
FOR: GIOBERT ®

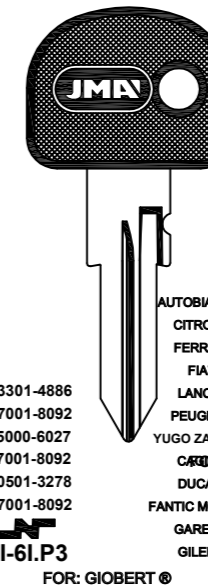

FOR:
FERRARI ®
FIAT ®
INNOCENTI ®
LANCIA ®
K 3301-4886
K 7001-8092
T 5000-6027
T 7001-8092
S 0501-3278
H 7001-8092
FI-6I.P3
FOR: GIOBERT ®

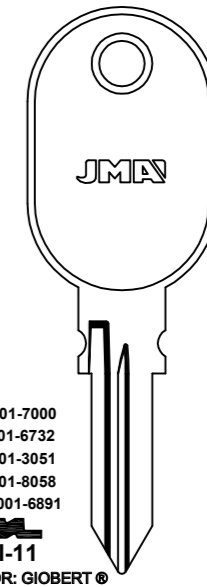

AUTOBIANCHI ®
CITROEN ®
FERRARI ®
FIAT ®
LANCIA ®
PEUGEOT ®
YUGO ZASTAVA ®
DUCATI ®
FANTIC MOTOR ®
GARELLI ®
GILERA ®
N 6001-7000
J 3001-6732
V 0001-3051
V 5001-8058
AB 6001-6891
FI-11
FOR: GIOBERT ®

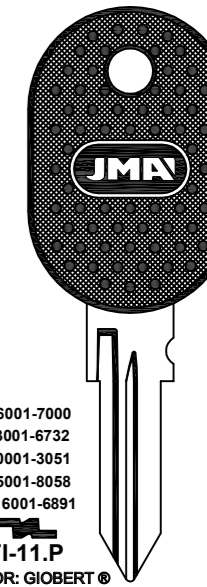

N 6001-7000
J 3001-6732
V 0001-3051
V 5001-8058
AB 6001-6891
FI-11.P
FOR: GIOBERT ®

Concerning the marks and commercial denominations see legal warning.
Concerniente a las marcas y denominaciones comerciales ver aviso legal.
Marka eta izendapen komertzialiei dagokienez, ikus lege-oharra.
Concernant les marques et dénominations commerciales voir la note dans l'index.

JMA Opening the future

JMA Opening the future

Beziehen auf die Marke und Handelsname sehen sie die Notiz im Impressum.
Relativamente às marcas e denominações comerciais, ver aviso legal.
Jeśli chodzi o znaki i nazwy handlowe, patrz Informacje prawne.



FOR: INNOCENTI®

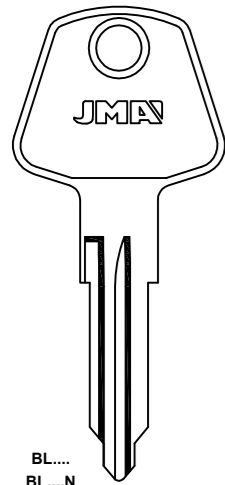

BL...
BL...N
1001-2000
LF-BL

FOR: L. & F.®
FOR: BRITAX®

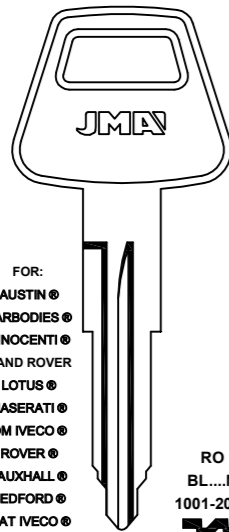

FOR:
AUSTIN®
CARBODIES®
INNOCENTI®
LAND ROVER®
LOTUS®
MASERATI®
OM IVECO®
ROVER®
VAUXHALL®
BEDFORD®
FIAT IVECO®

RO
BL...N
1001-2000
LF-RO

FOR: L. & F.®

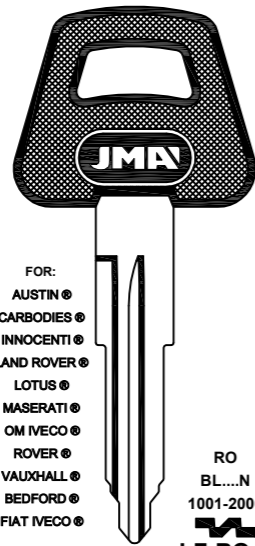

FOR:
AUSTIN®
CARBODIES®
INNOCENTI®
LAND ROVER®
LOTUS®
MASERATI®
OM IVECO®
ROVER®
VAUXHALL®
BEDFORD®
FIAT IVECO®

RO
BL...N
1001-2000
LF-RO.P

FOR: L. & F.®

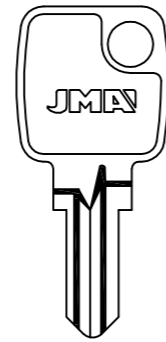

K...4-6-8
K...4-6-8-A-B-C

PJ-K
FOR: PJ®

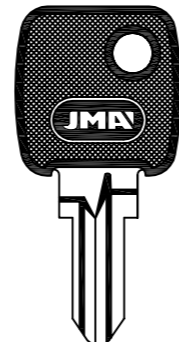

K...4-6-8
K...4-6-8-A-B-C

PJ-K.P
FOR: PJ®

FOR: INNOCENTI®

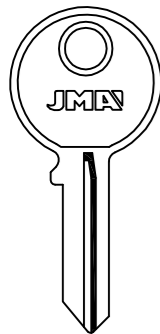

NRA
FFE...1-100
FJA...1-100
FL...251-500
NRA...51-90
YFB...1-75
FMD...1-75
FG...1-30
NF...1-30
EJR...1-75

UN-FFE



UN-3
UN-FP

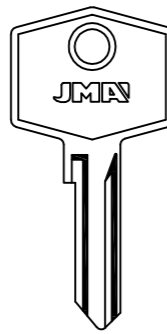

MC...1-40
MRA...251-290
MRN...1-54
MRN...201-250
MRN...251-300

UN-MRN



HX...100
UN-2
UN-FR

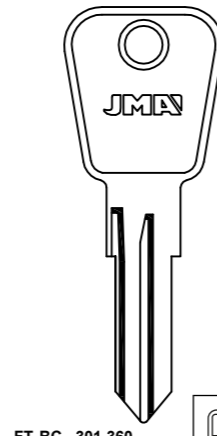

FT-BC...301-360
BC-FT...101-225
LF...451-575
CB...801-875

UN-FK
UN-FS
UN-FT
UN-TF

FOR: UNION®
FOR: WBH®

FOR: UNION®
FOR: CEM®

FOR: INTER HARVESTER®

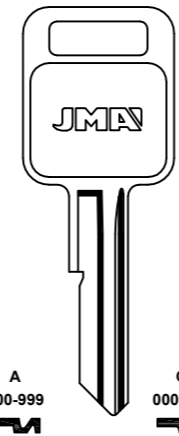

A
000-999
GM-6

E
000-999
GM-8

FOR: G.M.®
FOR: BRIGGS STRATTON®



C
000-999
GM-7

J
000-999
GM-9

FOR: G.M.®
FOR: BRIGGS STRATTON®

FOR: INTER.HARVESTER®



A
000-999
GM-6.P

E
000-999
GM-8.P

FOR: G.M.®
FOR: BRIGGS STRATTON®

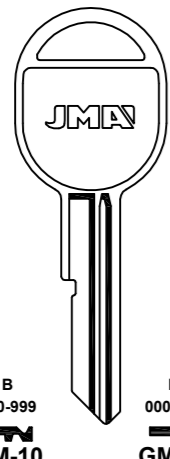

C
000-999
GM-7.P

J
000-999
GM-9.P

FOR: G.M.®
FOR: BRIGGS STRATTON®



B
000-999
GM-10

H
000-999
GM-12

FOR: G.M.®
FOR: BRIGGS STRATTON®

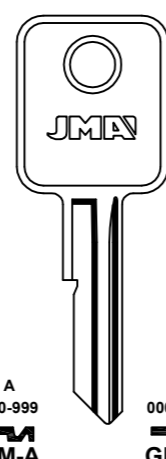

D
000-999
GM-11

K
000-999
GM-13

FOR: G.M.®
FOR: BRIGGS STRATTON®

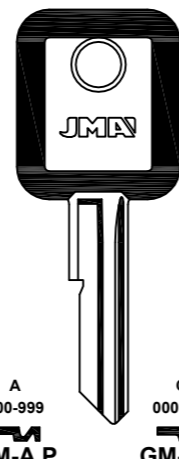

A
000-999
GM-A

E
000-999
GM-E

FOR: G.M.®
FOR: BRIGGS STRATTON®

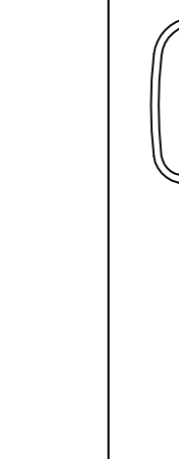

C
000-999
GM-C

J
000-999
GM-J

FOR: G.M.®
FOR: BRIGGS STRATTON®

FOR: INTER.HARVESTER®

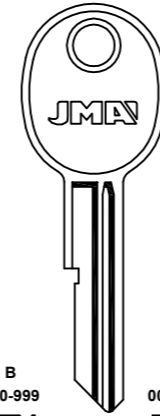

B
000-999
GM-B

H
000-999
GM-H

FOR: G.M.®
FOR: BRIGGS STRATTON®

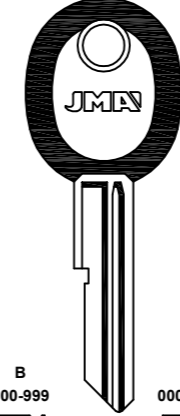

D
000-999
GM-D

K
000-999
GM-K

FOR: G.M.®
FOR: BRIGGS STRATTON®

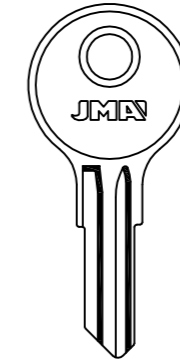

A...201-1050
C...500-699
H...601-1100
HM...201-1050

HUD-1
HUD-1D

FOR: HUDSON®

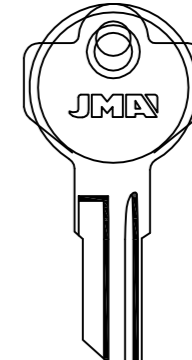

C...
250-499
1701-1950

KEN-1
KEN-1D

FOR: KENWORTH®

FOR: IRMSCHER®

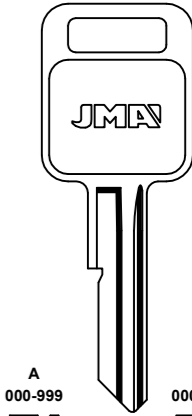

A
000-999
GM-6

E
000-999
GM-8

FOR: G.M.®
FOR: BRIGGS STRATTON®

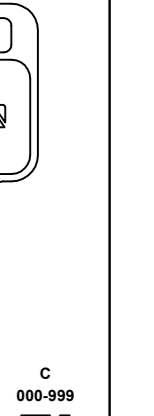

C
000-999
GM-7

J
000-999
GM-9

FOR: G.M.®
FOR: BRIGGS STRATTON®

FOR: IRMSCHER®



A
000-999
GM-6.P

E
000-999
GM-8.P

FOR: G.M.®
FOR: BRIGGS STRATTON®

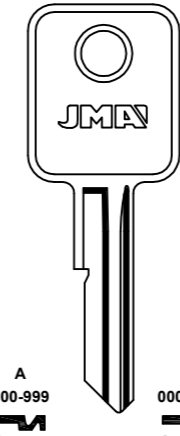

C
000-999
GM-7.P

J
000-999
GM-9.P

FOR: G.M.®
FOR: BRIGGS STRATTON®

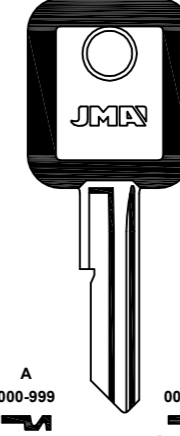

A
000-999
GM-A.P

E
000-999
GM-E.P

FOR: G.M.®
FOR: BRIGGS STRATTON®

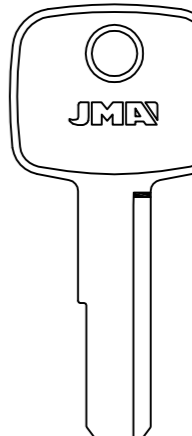

C
000-999
GM-C

J
000-999
GM-J

FOR: G.M.®
FOR: BRIGGS STRATTON®

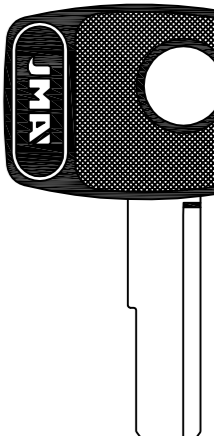

R...
1-1500
OP-R

R...
1-1500
OP-R.P

FOR: HUF®
FOR: YMOS®

FOR: IRMSCHER®

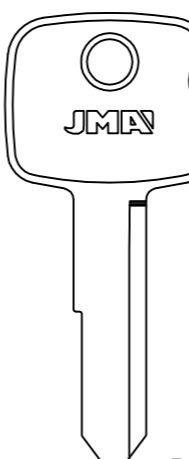

T...
1-500
501-1500
OP-T

FOR: HUF®
FOR: YMOS®

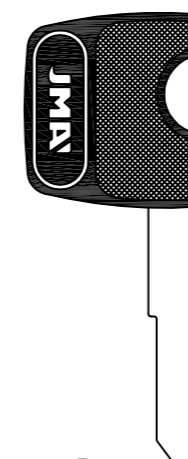

T...
1-500
501-1500
OP-T.P

FOR: HUF®
FOR: YMOS®

FOR: IRMSCHER®

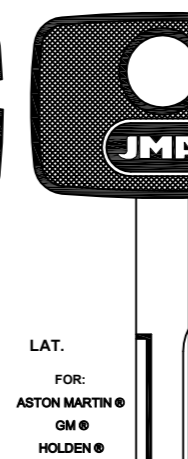

H...
WH...
0001-3000
OP-WH.P

LAT.
FOR:
ASTON MARTIN®
GM®
HOLDEN®
IRMSCHER®
OPEL®
VAUXHALL®

WY...
Y...
0001-3000
OP-WY.P

FOR: HUF®
FOR: YMOS®

FOR: ISUZU®

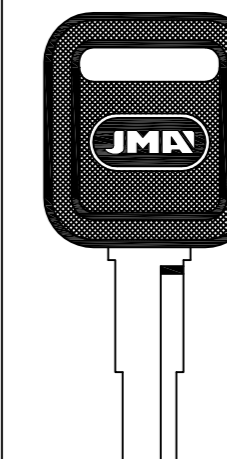

U
7001-8200
GM-1.P

FOR: G.M.®
FOR: BRIGGS STRATTON®

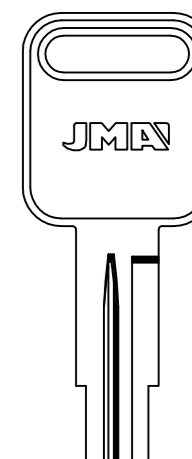

A
8001-9400
GM-2

FOR: G.M.®
FOR: BRIGGS STRATTON®

Concerning the marks and commercial denominations see legal warning.
Concerniente a las marcas y denominaciones comerciales ver aviso legal.
Marka eta izendapen komertzialiei dagokienez, ikus lege-oharra.
Concernant les marques et denominations commerciales voir la note dans l'index.

FOR: ISUZU ®

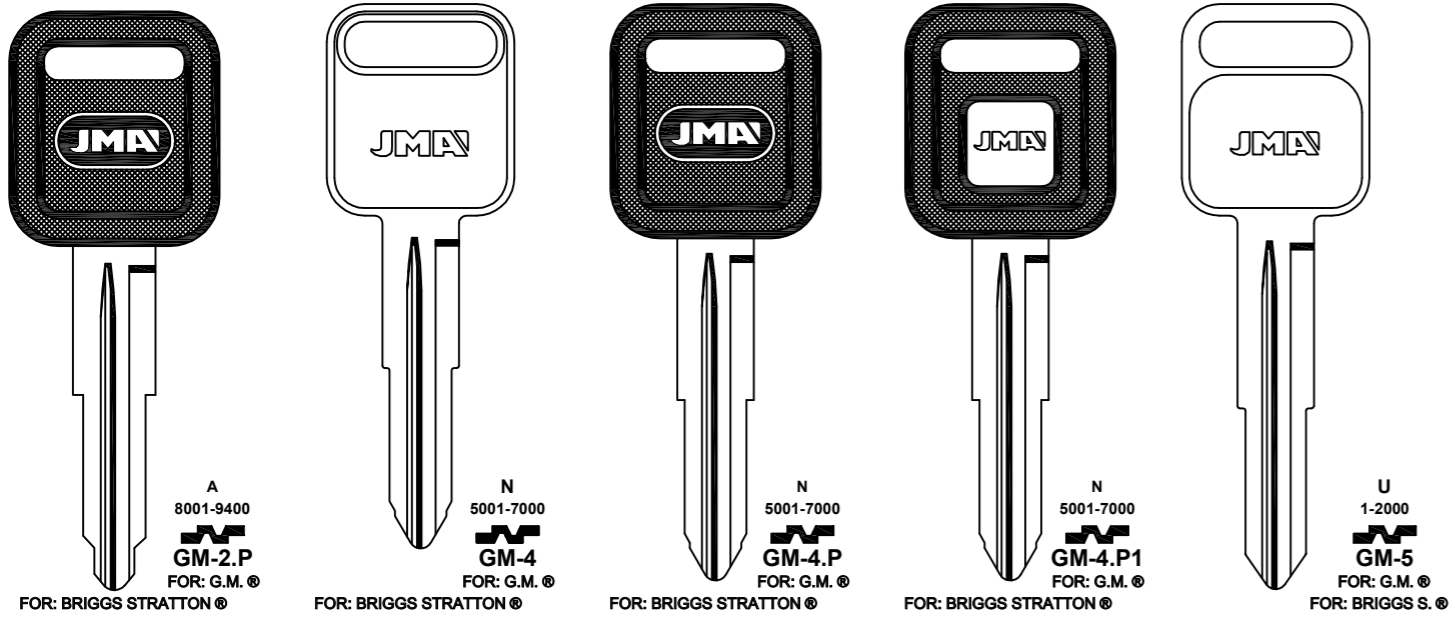

FOR: ISUZU ®

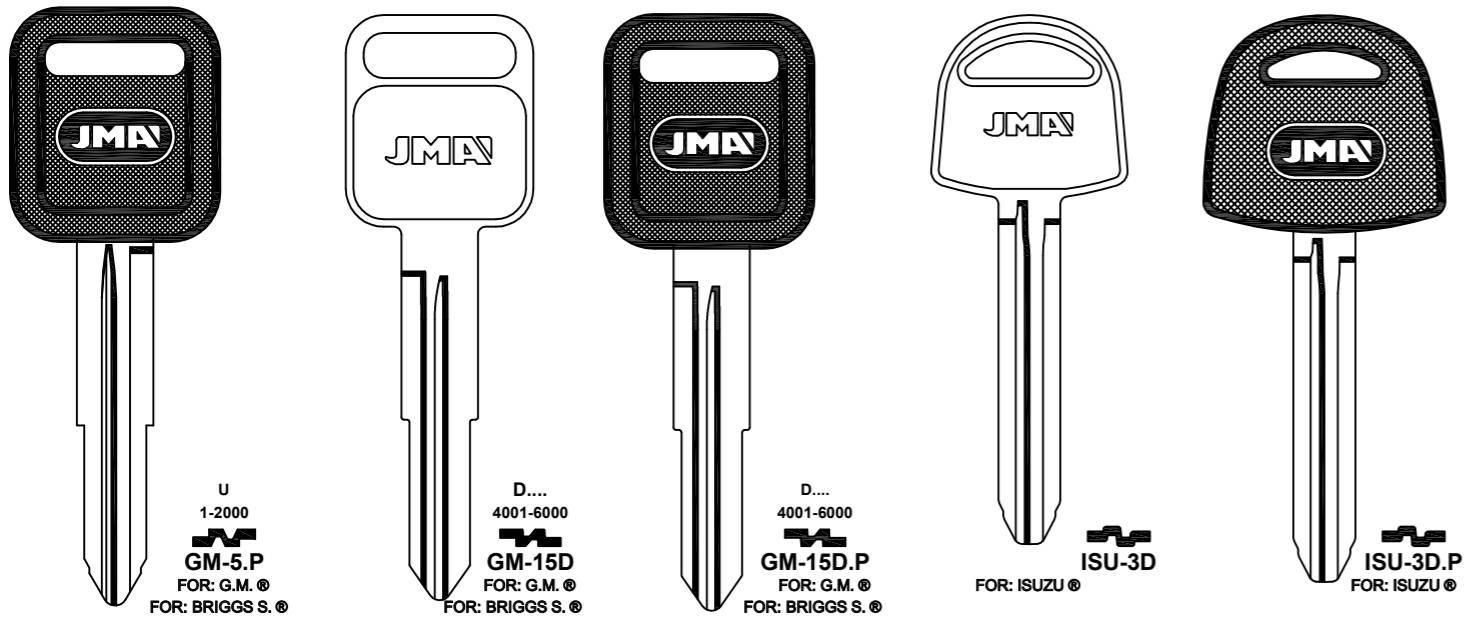

FOR: ISUZU ®

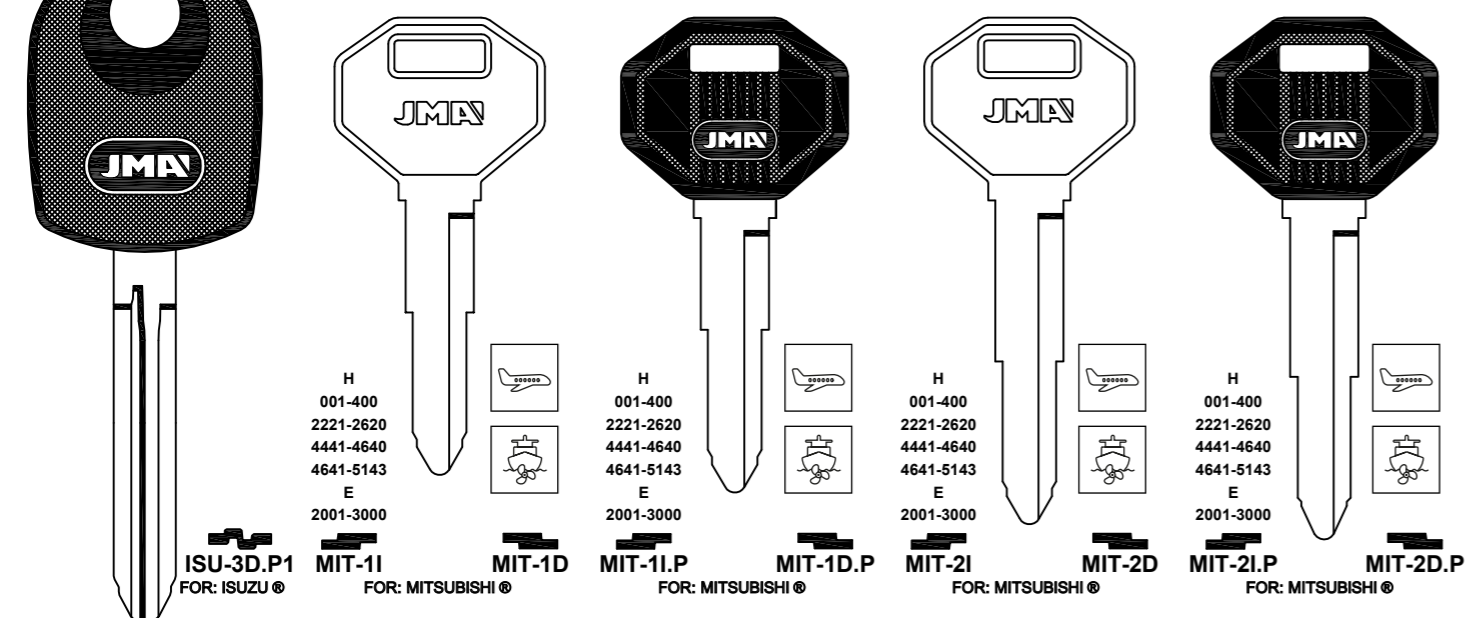

FOR: ISUZU ®

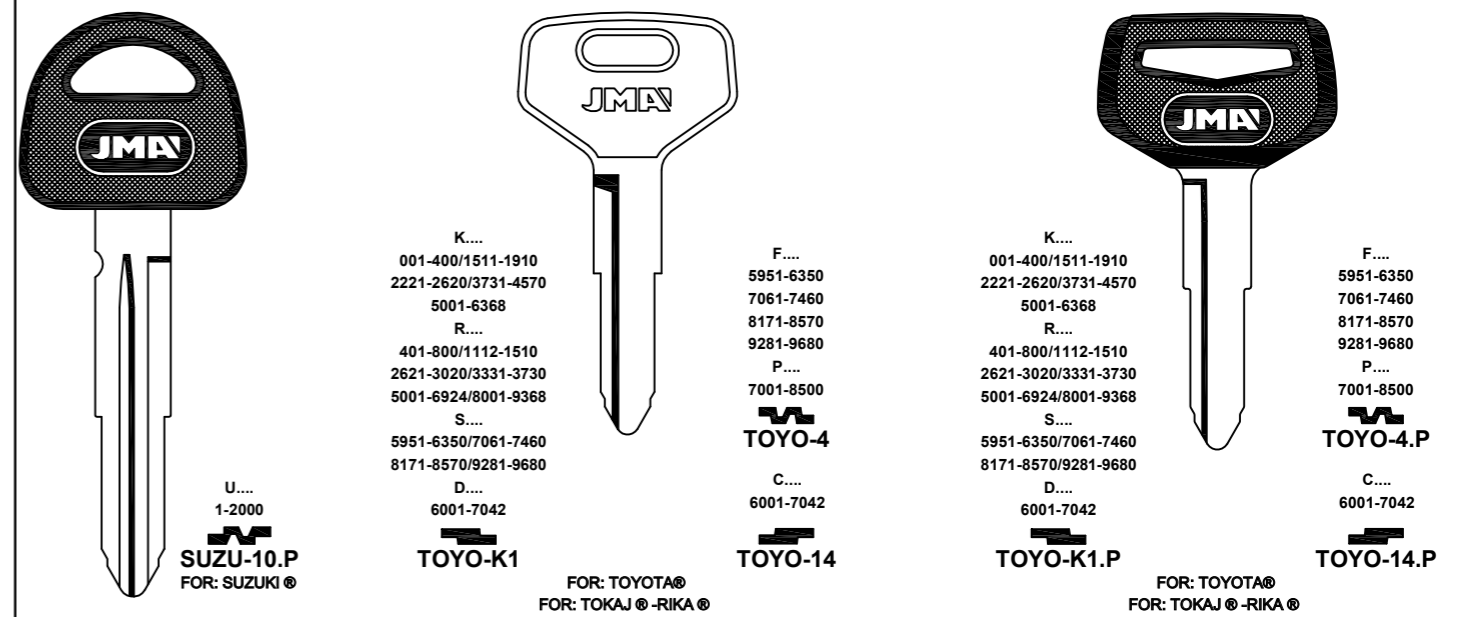

FOR: JAGUAR ®

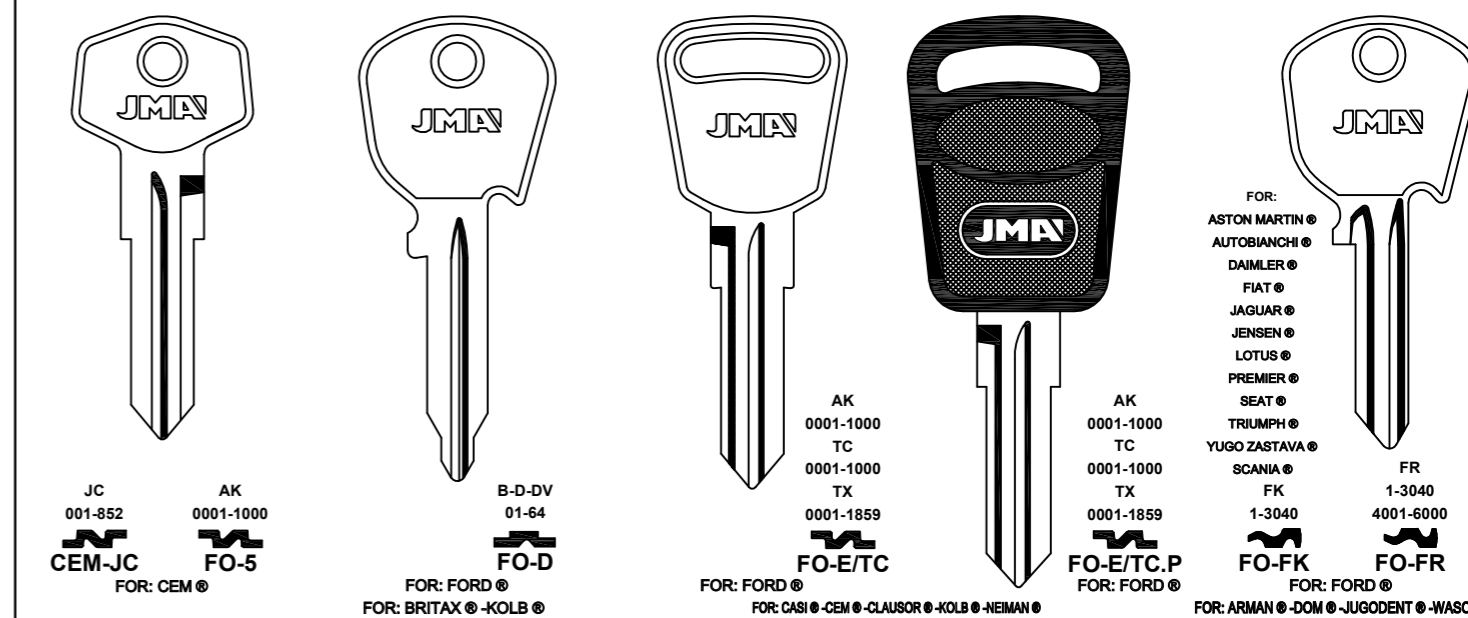

FOR: JAGUAR ®

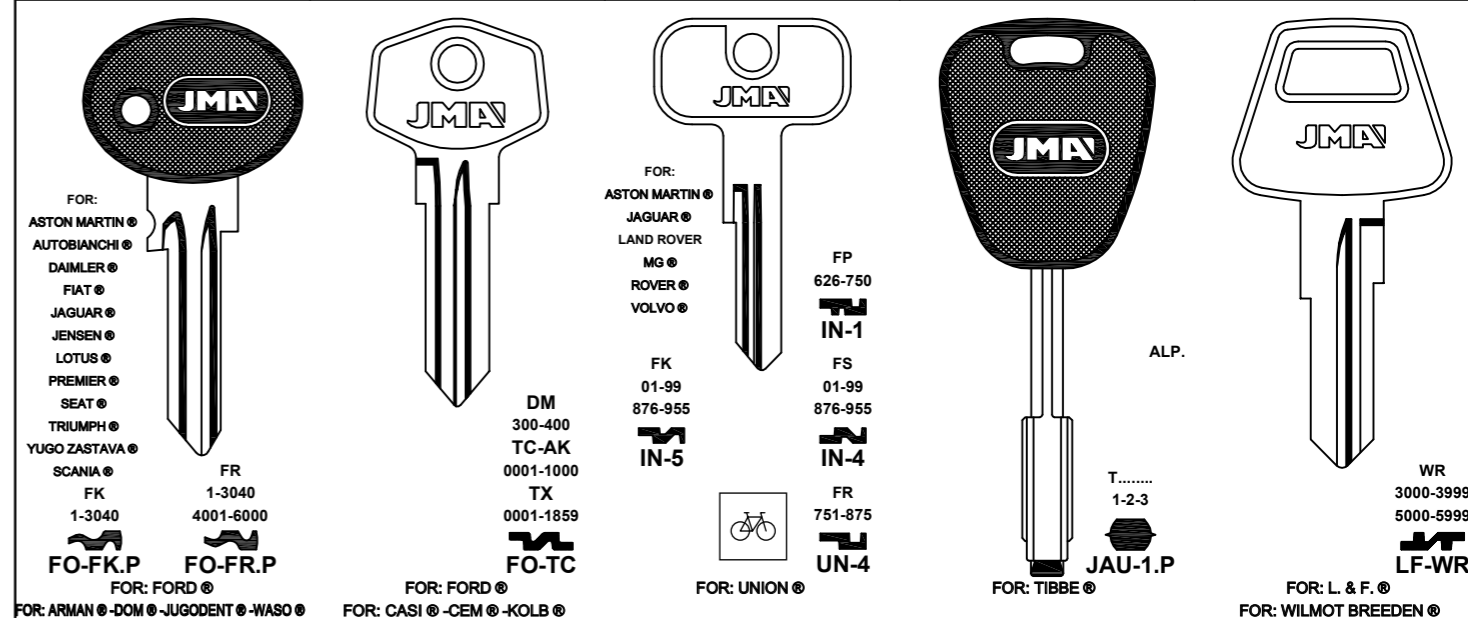

Concerning the marks and commercial denominations see legal warning.
Concieniente a las marcas y denominaciones comerciales ver aviso legal.
Marka eta izendapen komertzialiei dagokienez, ikus lege-oharra.
Concernant les marques et denominations commerciales voir la note dans l'index.

JMA Opening the future

JMA Opening the future

Beziehen auf die marke und handelsname sehen sie die notiz im Impressum.
Relativamente às marcas e denominações comerciais, ver aviso legal.
Jeśli chodzi o znaki i nazwy handlowe, patrz Informacje prawne.

FOR: KENWORTH®

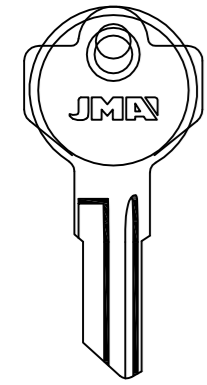

C....
250-499
1701-1950



KEN-1
FOR: KENWORTH®

KEN-1D
FOR: KENWORTH®

FOR: KIA®

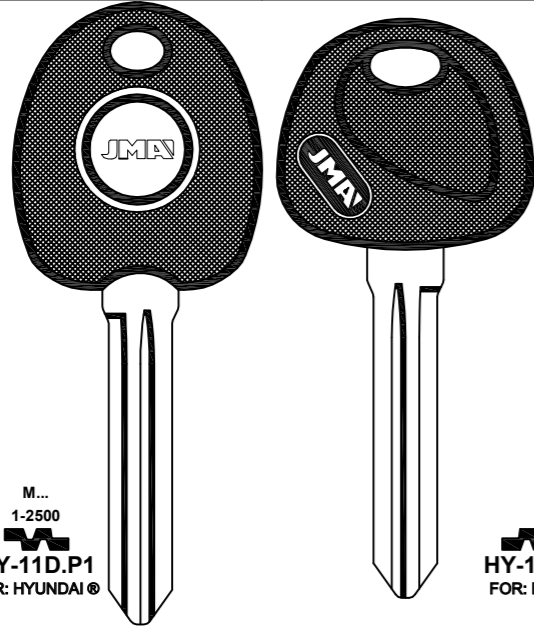

M...
1-2500

HY-11D.P1
FOR: HYUNDAI®

M...
1-2500

HY-11.P3
FOR: HYUNDAI®

HY-11D.P3
FOR: HYUNDAI®

WA...
1001-3040

HY-12.P3
FOR: HYUNDAI®

FOR: LADA-BAKONY®

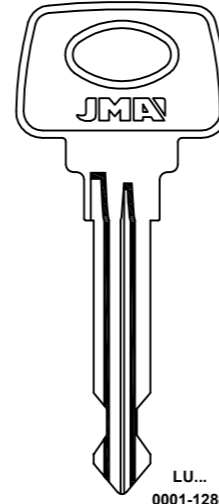

LU...
0001-1280

LA-1D
FOR: LADA-BAKONY®

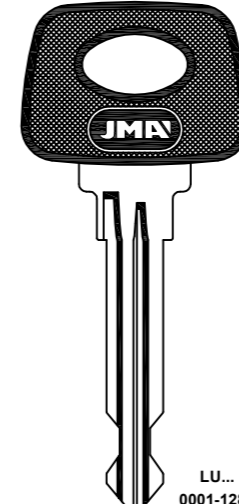

LU...
0001-1280

LA-1D.P
FOR: LADA-BAKONY®

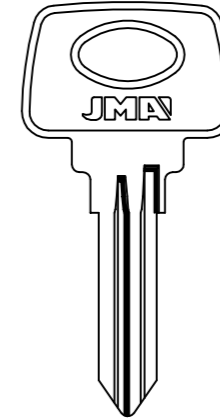

TU...
0001-1000

LA-2
FOR: LADA-BAKONY®

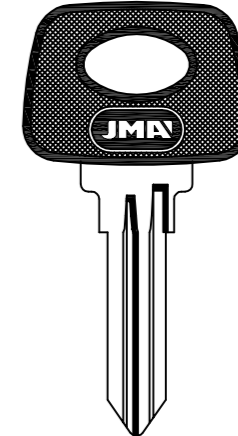

TU...
0001-1000

LA-2.P
FOR: LADA-BAKONY®

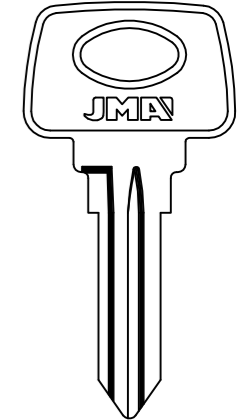

... AL 3

LA-3D
FOR: LADA-MOSKVITCH®

FOR: KIA®

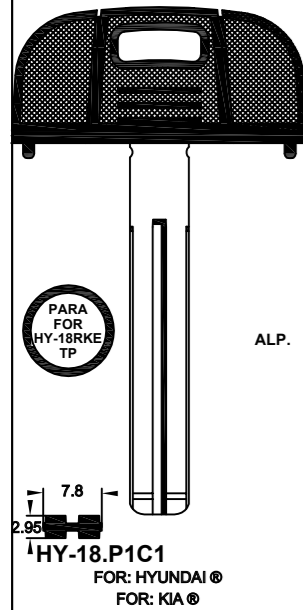

PARA FOR HY-18RKE TP

7.8
2.95

HY-18.P1C1
FOR: HYUNDAI®
FOR: KIA®

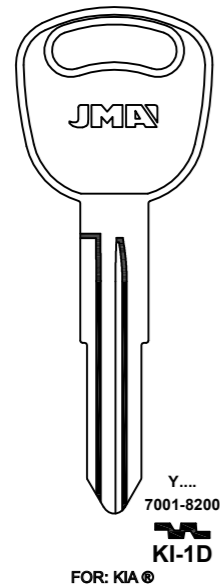

Y...
7001-8200

KI-1D
FOR: KIA®

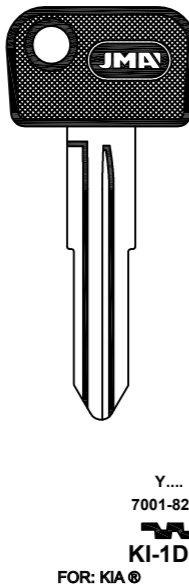

Y...
7001-8200

KI-1D.P
FOR: KIA®

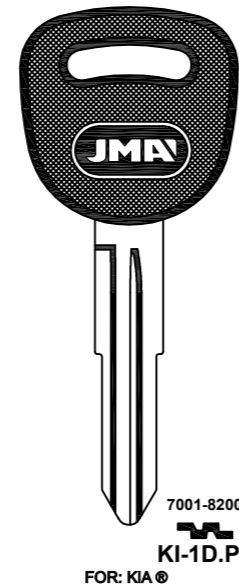

Y...
7001-8200

KI-1D.P1
FOR: KIA®

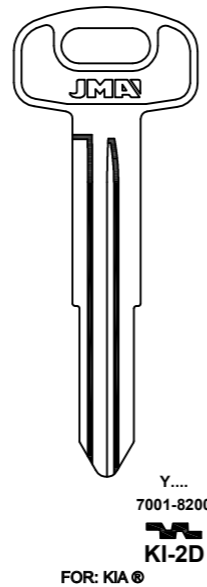

Y...
7001-8200

KI-2D
FOR: KIA®

FOR: LADA-BAKONY®

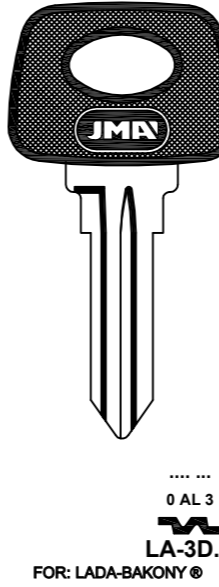

... AL 3

LA-3D.P
FOR: LADA-BAKONY®

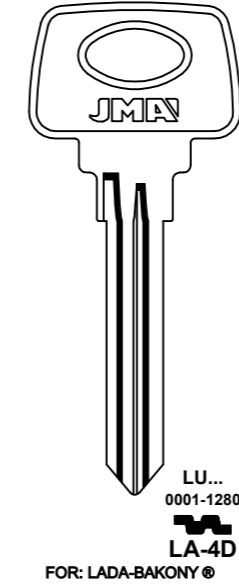

LU...
0001-1280

LA-4D
FOR: LADA-BAKONY®

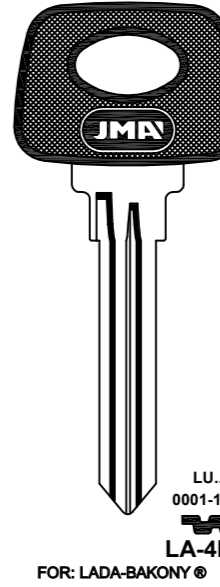

LU...
0001-1280

LA-4D.P
FOR: LADA-BAKONY®

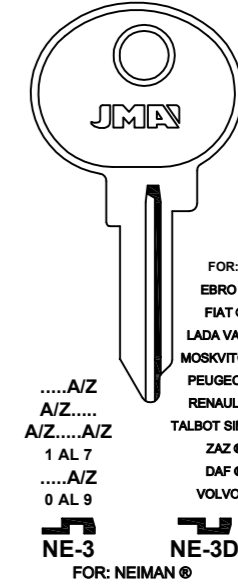

...A/Z
A/Z.....
A/Z.....A/Z

1 AL 7
...A/Z
0 AL 9

NE-3
FOR: NEIMAN®
FOR: CLAUSOR®

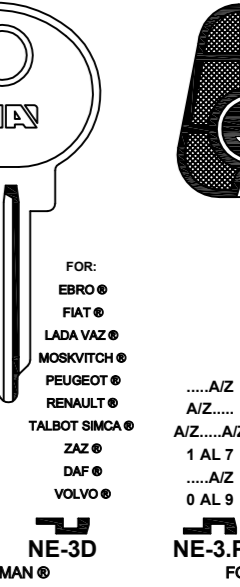

...A/Z
A/Z.....
A/Z.....A/Z

1 AL 7
...A/Z
0 AL 9

NE-3D
FOR: NEIMAN®
FOR: CLAUSOR®

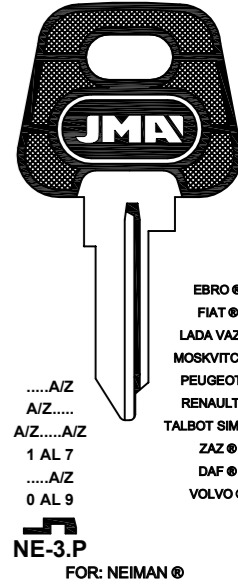

...A/Z
A/Z.....
A/Z.....A/Z

1 AL 7
...A/Z
0 AL 9

NE-3.P
FOR: NEIMAN®
FOR: CLAUSOR®

FOR: KIA®

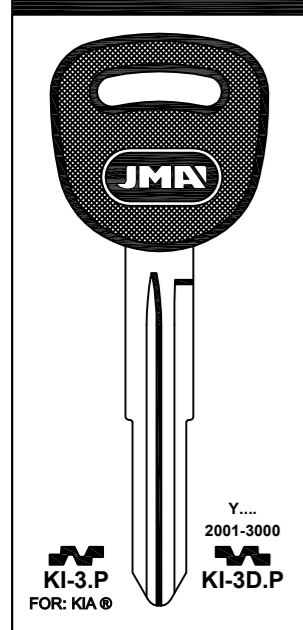

Y...
2001-3000

KI-3.P
FOR: KIA®

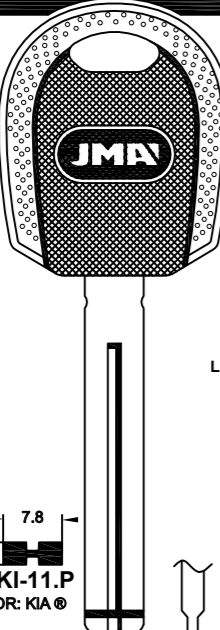

7.8
2.95

KI-11.P
FOR: KIA®



LAT.

7.8
2.95

KI-12.P
FOR: KIA®

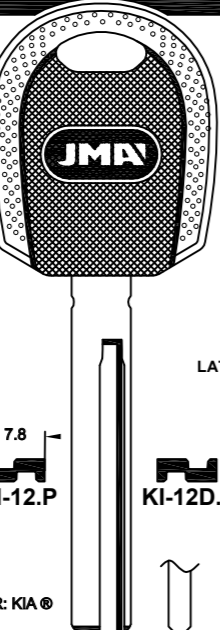

LAT.

KI-12D.P
FOR: KIA®

FOR: LADA VAZ®

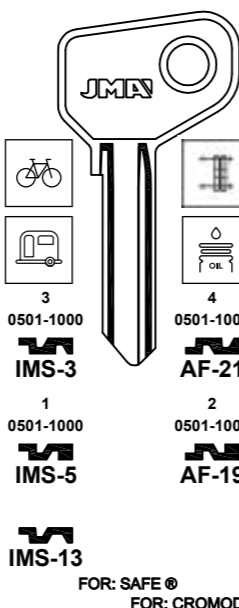

3
0501-1000

IMS-3

1
0501-1000

IMS-5

IMS-13

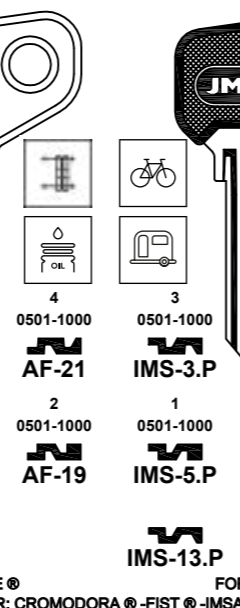

4
0501-1000

AF-21

2
0501-1000

AF-19

IMS-13.P

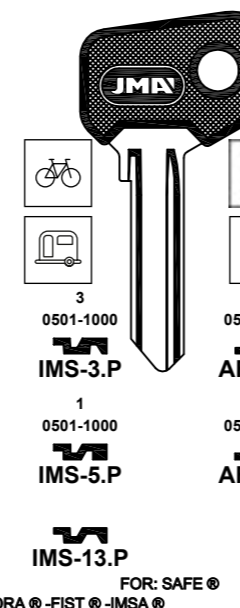

3
0501-1000

IMS-3.P

1
0501-1000

IMS-5.P

IMS-13.P

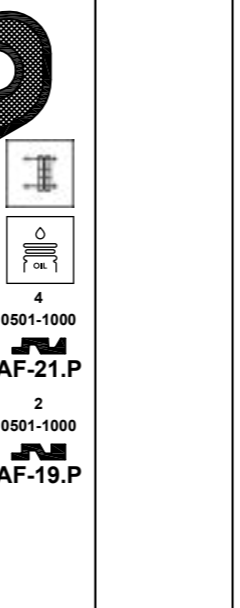

4
0501-1000

AF-21.P

2
0501-1000

AF-19.P

IMS-13.P

FOR: SAFE®
FOR: CROMODORA® -FIST® -IMS®

FOR: LADA-BAKONY®

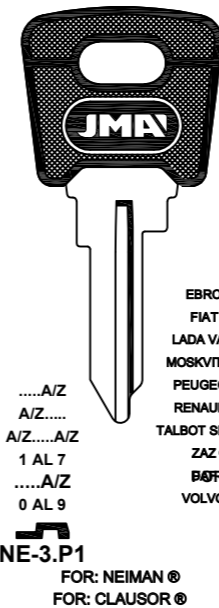

...A/Z
A/Z.....
A/Z.....A/Z

1 AL 7
...A/Z
0 AL 9

NE-3.P1
FOR: NEIMAN®
FOR: CLAUSOR®

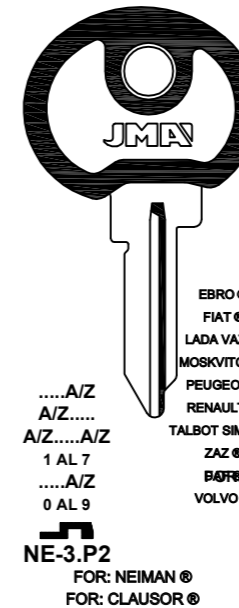

...A/Z
A/Z.....
A/Z.....A/Z

1 AL 7
...A/Z
0 AL 9

NE-3.P2
FOR: NEIMAN®
FOR: CLAUSOR®

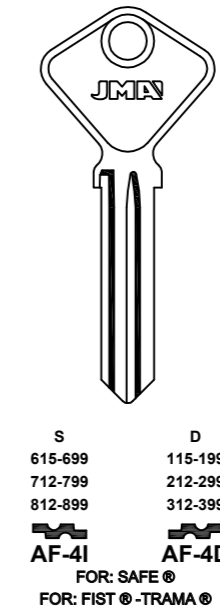

S
615-699
712-799
812-899

AF-4I
FOR: SAFE®

D
115-199
212-299
312-399

AF-4D
FOR: SAFE®

FOR: LAMBORGHINI®

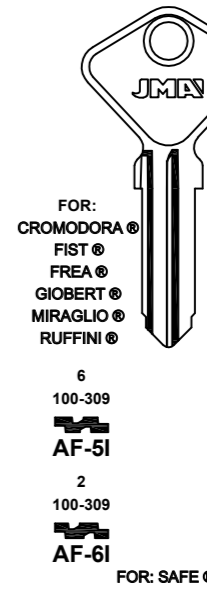

FOR: CROMODORA®
FIST®
GIOBERT®
MIRAGLIO®
RUFFINI®

6
100-309

AF-5I

2
100-309

AF-6I

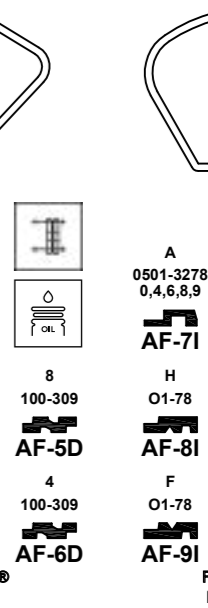

FOR: CROMODORA®
FIST®
GIOBERT®
MIRAGLIO®
RUFFINI®

8
100-309

AF-5D

4
100-309

AF-6D

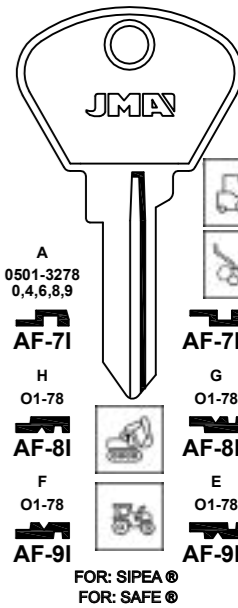

A
0501-3278
0,4,6,8,9

AF-7I

H
01-78

AF-8I

F
01-78

AF-9I



G
01-78

AF-8D

E
01-78

AF-9D

FOR: SIPEA®
FOR: SAFE®

Concerning the marks and commercial denominations see legal warning.
Concerniente a las marcas y denominaciones comerciales ver aviso legal.
Marka eta izendapen komertzialiei dagokienez, ikus lege-oharra.
Concernant les marques et dénominations commerciales voir la note dans l'index.

FOR: LANCIA ®

ALP.

0111111
FOR: AL ®
628888

B....501-3278
B.....0-4-6-8-9

SIP-3
FOR: SIPEA ®

SIX-3.P1
FOR: SIMPLEX ®

FOR: ARTEB ® -CLAUSOR ® -NEIMAN ® FOR: CITROEN ® -FIAT ® -LANCIA ® -PEUGEOT ®

FOR: LAND-RANGE ROVER ®

15

AB-6I AB-6D
FOR: PROAUTO ®

14 13

AB-8I AB-8D
FOR: ABSA ®

2,3,4,5,6,7,8

IMS-7
FOR: IMSA ®

2,3,4,5,6,7,8

IMS-7.P
FOR: IMSA ®

FOR: LAND-RANGE ROVER ®

NRA
FFE...1-100
FJA...1-100
FL...251-500
NRA...51-90
YFB...1-75
FMD...1-75
FG...1-30
NF...1-30
EJR...1-75

UN-FFE UN-3 UN-FP

MC...1-40
MRA...251-290
MRN...1-54
MRN...201-250
MRN...251-300

UN-MRN UN-2 UN-FR

FR...
626-750
UN-FP

FR...
751-875
UN-FR

FA...
501-625
UN-44

RM...
911-952
UN-44D

NGN...1-54
UN-NG

FK...
01-99
876-955
UN-FK

FS...
01-99
876-955
UN-FS

L.....
8001-10000
NE-52.P
FOR: NEIMAN ®

FS...1-99
FS...876-955
UN-1FS

FA...
501-625
UN-44

RM...
911-952
UN-44D

NGN...1-54
UN-NG

FK...
01-99
876-955
UN-FK

FS...
01-99
876-955
UN-FS

FOR: UNION ® FOR: WBH ®

FOR: LAND-RANGE ROVER ®

FOR:
ASTON MARTIN ®
JAGUAR ®
LAND ROVER
MG ®
ROVER ®
VOLVO ®

FP
626-750

IN-1

FK
01-99
876-955

IN-5

FOR: UNION ®

FOR:
AUSTIN ®
CARBODIES ®
INNOCENTI ®
LAND ROVER
LOTUS ®
MASERATI ®
OM IVECO ®
ROVER ®
VAUXHALL ®
BEDFORD ®
FIAT IVECO ®

RO
BL...N
1001-2000

LF-RO

FOR: L. & F. ®

FOR:
AUSTIN ®
CARBODIES ®
INNOCENTI ®
LAND ROVER
LOTUS ®
MASERATI ®
OM IVECO ®
ROVER ®
VAUXHALL ®
BEDFORD ®
FIAT IVECO ®

RO
BL...N
1001-2000

LF-RO.P

FOR: L. & F. ®

NSP....
4000-4999
7001-9000
E....
2001-3000
4001-5000
S....
2001-3000

NE-11

FOR: NEIMAN ®

NSP....
4000-4999
7001-9000
E....
2001-3000
4001-5000
S....
2001-3000

NE-11.P

FOR: NEIMAN ®

FOR: LAND-RANGE ROVER ®

FT-BC...301-360
BC-FT...101-225
LF...451-575
CB...801-875

UN-FT

TF
TF...1001-1140

UN-TF

FOR: UNION ® FOR: CEM ®

NH....
2001-3000

UN-NH

FOR: UNION ® FOR: CEM ®

FOR: LEXUS (TOYOTA) ®

LAT.

LAT.

ALP.

0111111
AL
628888

SIX-3.P
FOR: SIMPLEX ®

TOYO-41.P

TOYO-18.P
FOR: TOYOTA ®

TOYO-30.P1
FOR: TOYOTA ®

FOR: TOKAJ ® -RIKA ®

FOR: LIGIER ®

0111111
AL
628888

SIX-3.P
FOR: SIMPLEX ®

FOR: LAND-RANGE ROVER ®

NSP....
4000-4999
7001-9000
E....
2001-3000
4001-5000
S....
2001-3000

NE-11.P1

FOR: NEIMAN ®

NSP....
4000-4999
7001-9000
E....
2001-3000
4001-5000
S....
2001-3000

NE-11.P2

FOR: NEIMAN ®

NSP....
4000-4999
7001-9000
E....
2001-3000
4001-5000
S....
2001-3000

NE-24

FOR: NEIMAN ®

NSP....
4000-4999
7001-9000
E....
2001-3000
4001-5000
S....
2001-3000

NE-24.P

FOR: NEIMAN ®

NSP....
4000-4999
7001-9000
E....
2001-3000
4001-5000
S....
2001-3000

NE-24.P1

FOR: NEIMAN ®

FOR: LINCOLN ®

FB-PB
0000-1863

FO-1

FO-3

FOR: FORD ®

AF
0001-2600
FA-PA
0000-1863

FO-2

FOR: FORD ®

A
101-291
501-579

B
101-332
501-602

C
101-344
501-624

D
101-327
501-602

E
101-296
501-579

FA
6500-7733

FO-11D

FOR: FORD ®

A
101-291
501-579

B
101-332
501-602

C
101-344
501-624

D
101-327
501-602

E
101-296
501-579

FA
6500-7733

FO-20D

FOR: FORD ®

FOR: LOTUS ®

FOR:
ASTON MARTIN ®
AUTOBIANCHI ®
DAIMLER ®
FIAT ®
JAGUAR ®
JENSEN ®
LOTUS ®
PREMIER ®
SEAT ®
TRIUMPH ®
YUGO ZASTAVA ®

SCANIA ®
FR
1-3040
4001-6000

FO-FK

FO-FR

FOR: FORD ®

Concerning the marks and commercial denominations see legal warning.
Conceniende a las marcas y denominaciones comerciales ver aviso legal.
Marka eta izendapen komertzialiei dagokienez, ikus lege-oharra.
Concernant les marques et denominations commerciales voir la note dans l'index.



Beziehen auf die marke und handelsname sehen sie die notiz im Impressum.
Relativamente às marcas e denominações comerciais, ver aviso legal.
Jeśli chodzi o znaki i nazwy handlowe, patrz Informacje prawne.

FOR: MASERATI®

AF
0001-2600
FA-PA
0000-1863
FO-2
FOR: FORD®

GIOB-1D
FOR: GIOBERT®

GIOB-21.P
FOR: GIOBERT®

IMS-3
0501-1000
IMS-5
0501-1000
IMS-13
FOR: SAFE®
FOR: CROMODORA® -FIST® -IMS®

AF-21
0501-1000
AF-19
0501-1000
IMS-3.P
0501-1000
IMS-5.P
0501-1000
IMS-13.P
FOR: SAFE®
FOR: CROMODORA® -FIST® -IMS®

FOR: MASERATI®

FOR:
AUSTIN®
CARBODIES®
INNOCENTI®
LAND ROVER®
LOTUS®
MASERATI®
OM IVECO®
ROVER®
VAUXHALL®
BEDFORD®
FIAT IVECO®

RO
BL...N
1001-2000
LF-RO
FOR: L. & F.®

FOR:
AUSTIN®
CARBODIES®
INNOCENTI®
LAND ROVER®
LOTUS®
MASERATI®
OM IVECO®
ROVER®
VAUXHALL®
BEDFORD®
FIAT IVECO®

RO
BL...N
1001-2000
LF-RO.P
FOR: L. & F.®

C4..AA-ZY
D4..AA-HR
RO-5I
FOR: RONIS®
FOR: ABSA®

C3..AA-ZY
D3..AA-HR
J...1-544
RO-5D
FOR: RONIS®
FOR: ABSA®

FOR: MAZDA®

.....
.....A/Z
B-C-D-E
1/9...A/Z
1/9...A/Z
.....A/Z
B-D-E-G-H-J
.1/9...A/Z
.1/9...A/Z
E-M-N-P-R
CHR-3
FOR: CHRYSLER®
FOR: CLAUSSOR® -NEIMAN®

001-150
601-900
3-7
DAT-3I
001-150
601-900
1-5
DAT-4I
FOR: NISSAN®
FOR: DATSUN®

001-150
601-900
4-8
DAT-3D
001-150
601-900
6-9
DAT-4D
FOR: NISSAN®
FOR: DATSUN®

FOR: MAZDA®

VH
0001-3948
K
00001-14000
DAT-11
FOR: NISSAN®
FOR: DATSUN® -WASO®

VH
0001-3948
K
00001-14000
DAT-11D
FOR: NISSAN®
FOR: DATSUN® -WASO®

VH
0001-3948
K
00001-14000
DAT-11.P
FOR: NISSAN®
FOR: DATSUN® -WASO®

T
1 AL 4
T
0001-1050
FO-6.P
FOR: FORD®
FOR: HUF®

2000-2499
MAZ-1I
FOR: MAZDA®

1500-1999
5000-6100
MAZ-1D
FOR: MAZDA®

3000-3499
5000-6100
MAZ-2I
FOR: MAZDA®

2500-2999
3500-4600
MAZ-2D
FOR: MAZDA®

FOR: MAZDA®

3000-3499
5000-6100
MAZ-2I.P
FOR: MAZDA®

2500-2999
3500-4600
MAZ-2D.P
FOR: MAZDA®

6500-7733
MAZ-3I
FOR: MAZDA®

6500-7733
MAZ-3D
FOR: MAZDA®

MAZ-3I.P
FOR: MAZDA®

MAZ-3D.P
FOR: MAZDA®

MAZ-4
FOR: MAZDA®

MAZ-4.P
FOR: MAZDA®

FOR: MAZDA®

FA...
6500-7733
MAZ-5D
FOR: MAZDA®

FA...
6500-7733
MAZ-5D.P
FOR: MAZDA®

.....
6500-7733
MAZ-6
FOR: MAZDA®

.....
6500-7733
MAZ-6D
FOR: MAZDA®

MAZ-6.P
FOR: MAZDA®

MAZ-6D.P
FOR: MAZDA®

.....
10100-12099
MAZ-7D
FOR: MAZDA®

FOR: MAZDA®

.....
10100-12099
MAZ-7D.P
FOR: MAZDA®

.....
10100-12099
MAZ-7D.P1
FOR: MAZDA®

.....A...
101-291
501-579
...B...
101-332
501-602
...C...
101-344
501-624
...D...
101-327
501-602
...E...
101-296
501-579
MAZ-8D
FOR: MAZDA®

.....A...
101-291
501-579
...B...
101-332
501-602
...C...
101-344
501-624
...D...
101-327
501-602
...E...
101-296
501-579
MAZ-8D.P
FOR: MAZDA®

.....
10100-12099
MAZ-11D
FOR: MAZDA®

Concerning the marks and commercial denominations see legal warning.
Concerniente a las marcas y denominaciones comerciales ver aviso legal.
Marka eta izendapen komertzialiei dagokienez, ikus lege-oharra.
Concernant les marques et dénominations commerciales voir la note dans l'index.



FOR: MAZDA®

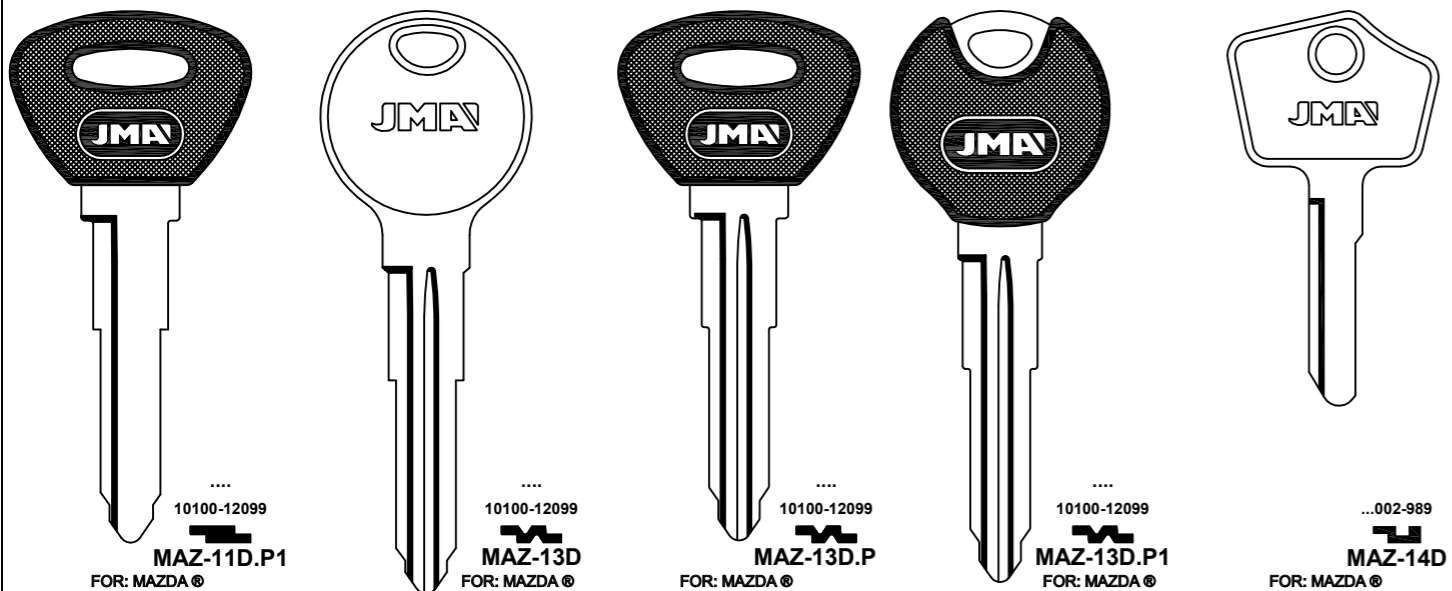

FOR: MERCEDES®

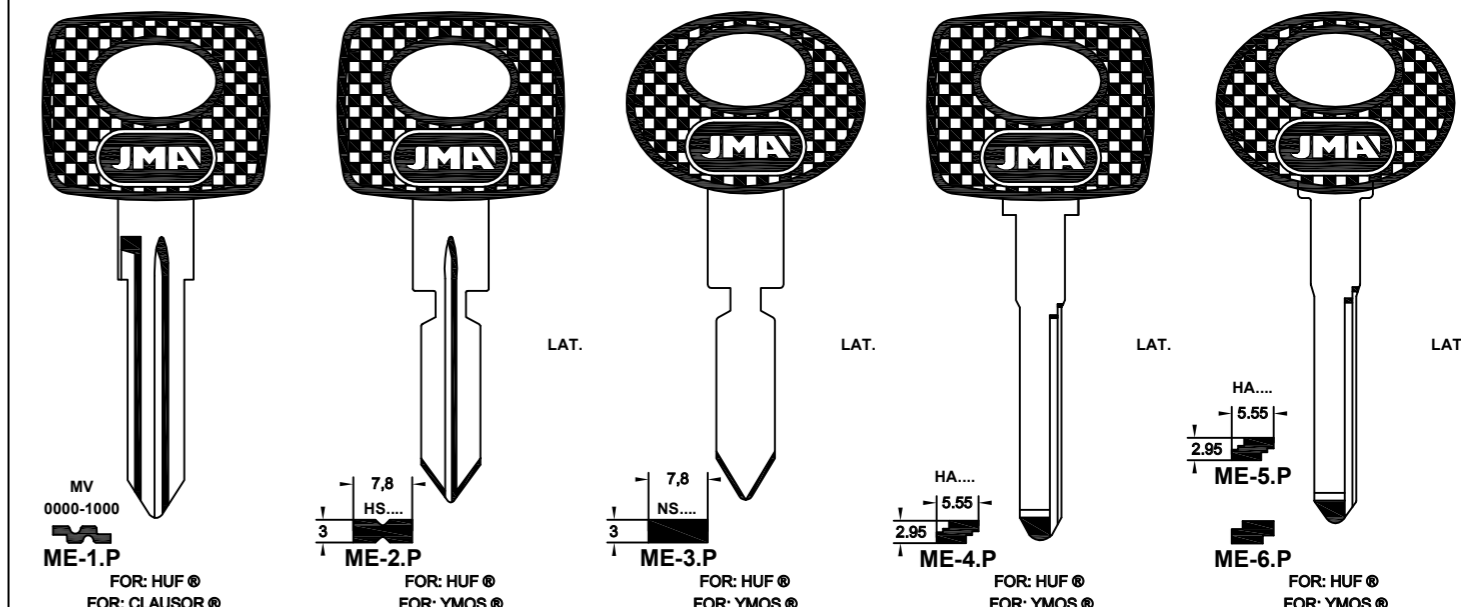

FOR: MAZDA®

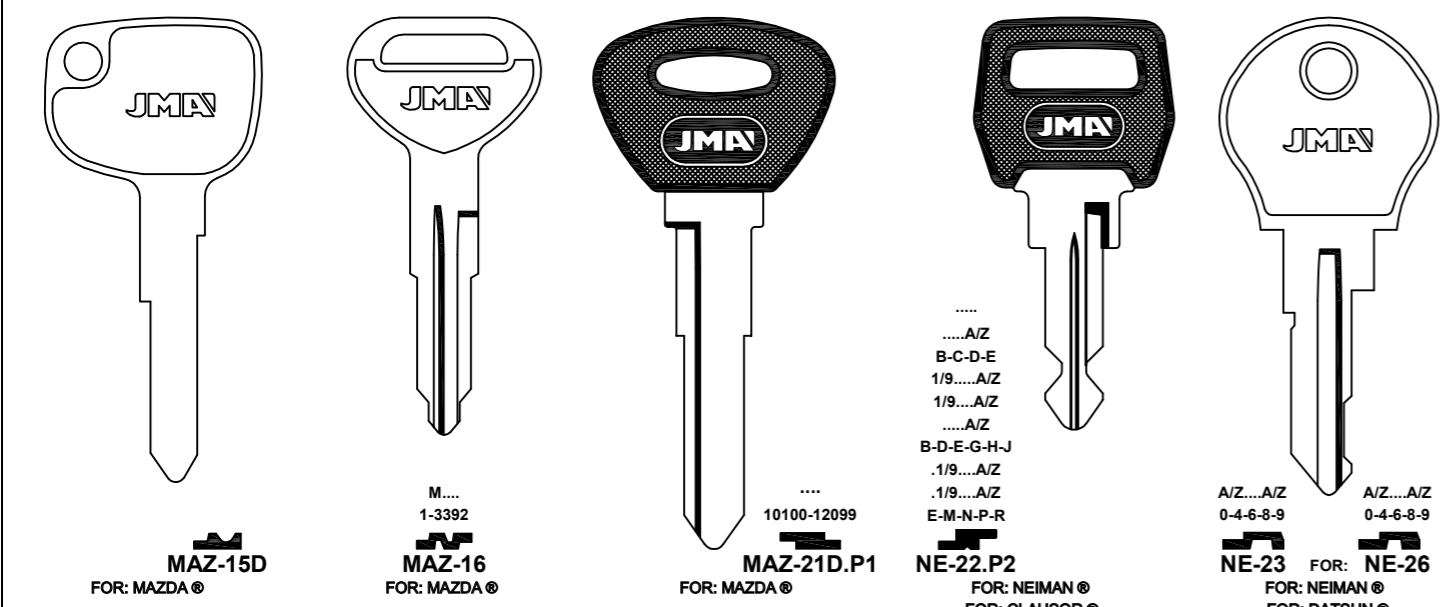

FOR: MERCEDES®

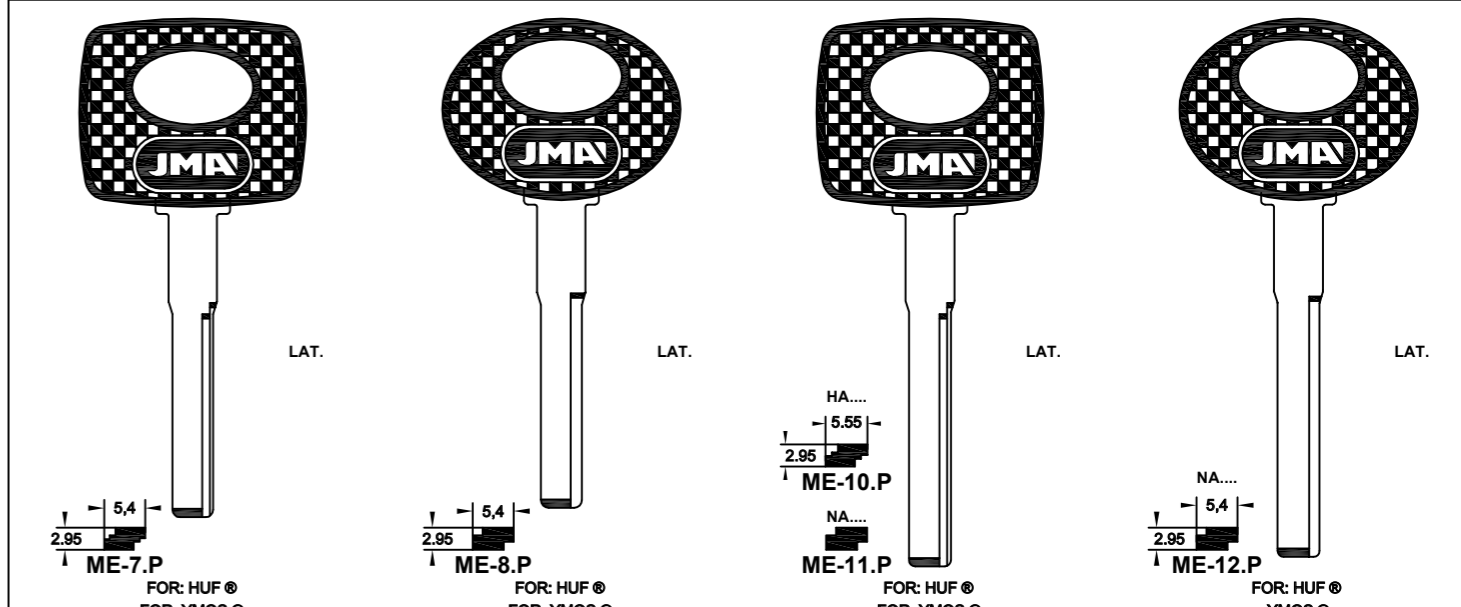

FOR: MAZDA®

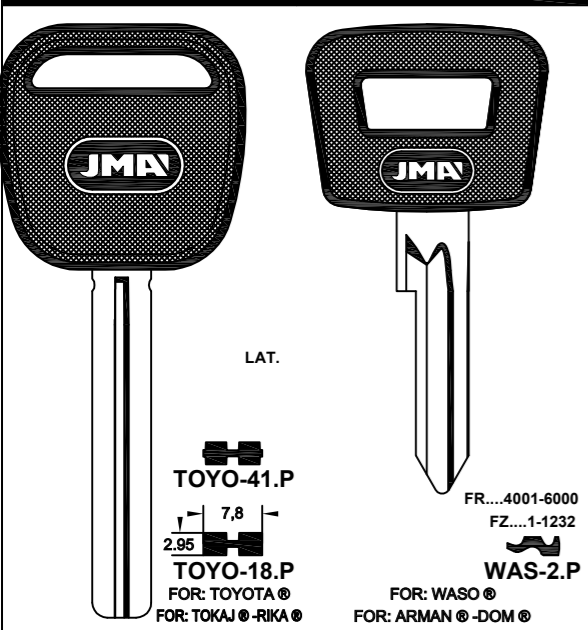

FOR: MERCEDES®

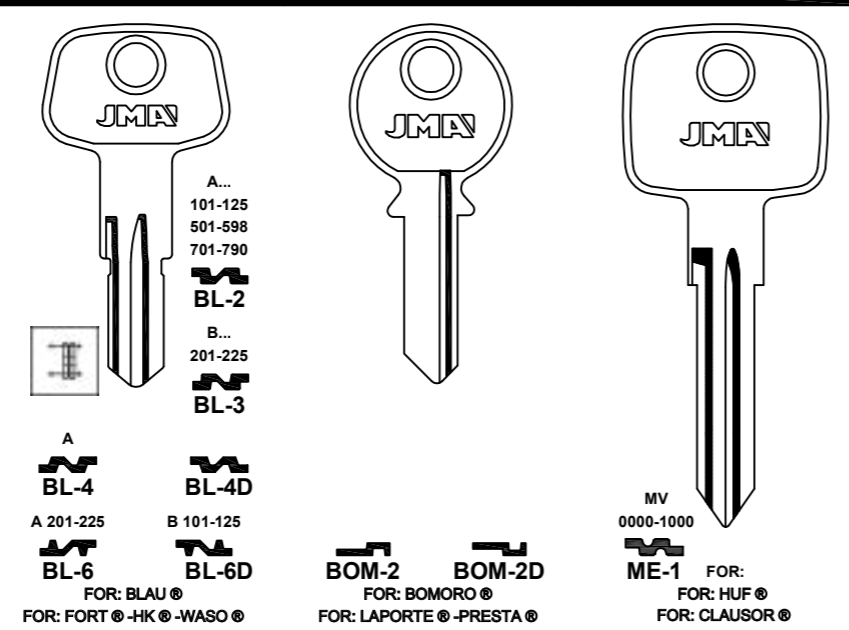

FOR: MERCEDES®

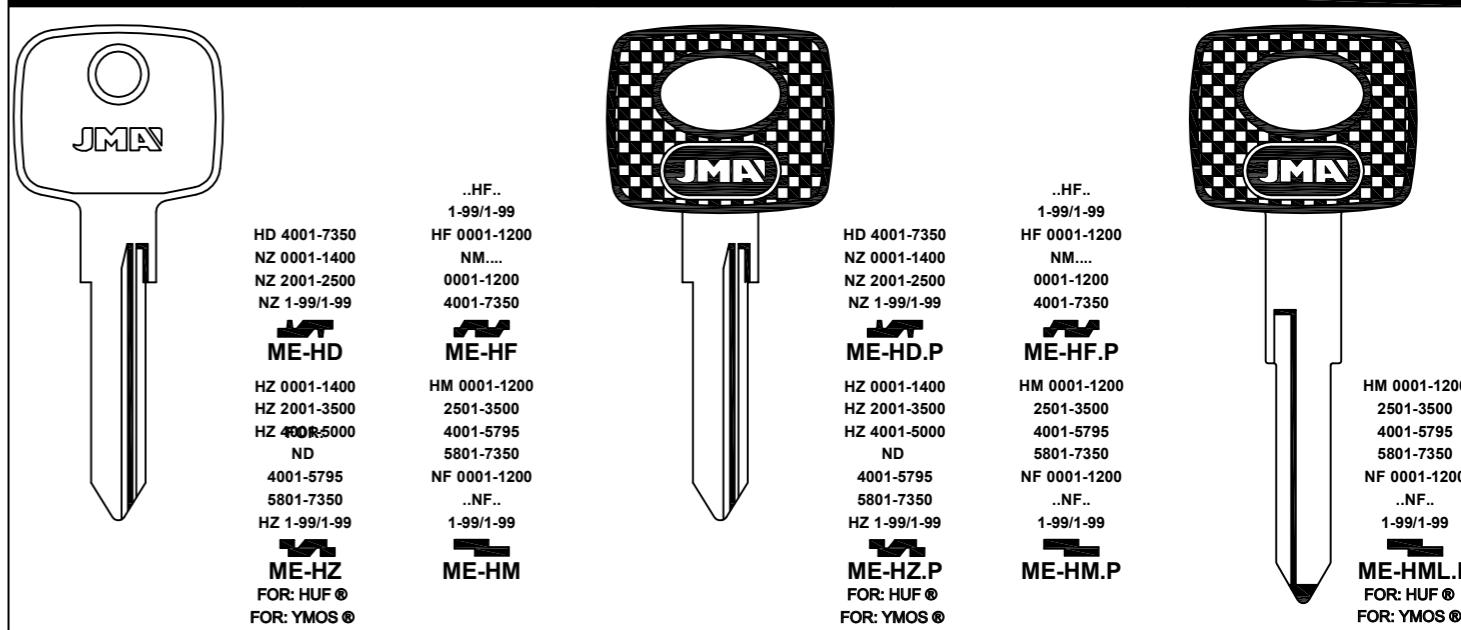

Concerning the marks and commercial denominations see legal warning.
 Concerniente a las marcas y denominaciones comerciales ver aviso legal.
 Marka eta izendapen komertzialiei dagokienez, ikus lege-oharra.
 Concernant les marques et denominations commerciales voir la note dans l'index.

JMA Opening the future

JMA Opening the future

Beziehen auf die marke und handelsname sehen sie die notiz im Impressum.
 Relativamente às marcas e denominações comerciais, ver aviso legal.
 Jeśli chodzi o znaki i nazwy handlowe, patrz Informacje prawne.

FOR: MERCEDES®

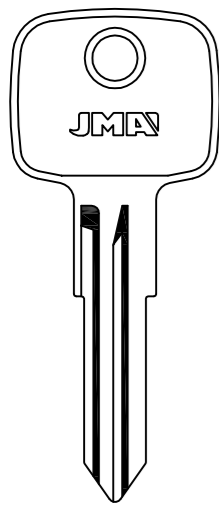

HU
6001-8130



ME-HU

NU
6001-8130



ME-NU

FOR: HUF®
FOR: YMOS®

HY
6001-8130



ME-HY

NY
6001-8130



ME-NY

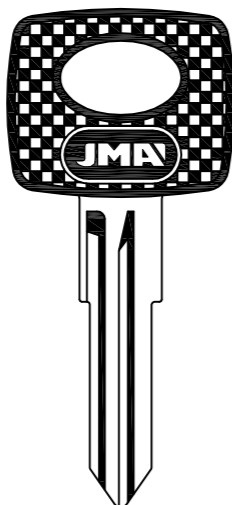

HU
6001-8130



ME-HU.P

NU
6001-8130



ME-NU.P

FOR: HUF®
FOR: YMOS®

HY
6001-8130



ME-HY.P

NY
6001-8130



ME-NY.P

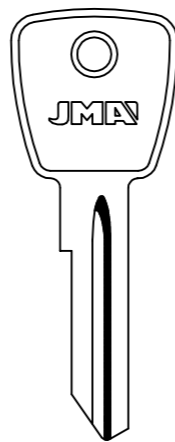

L
001-300



ME-L

FOR: HUF®
FOR: IMSA® -YMOS®

FOR: MERCURY®

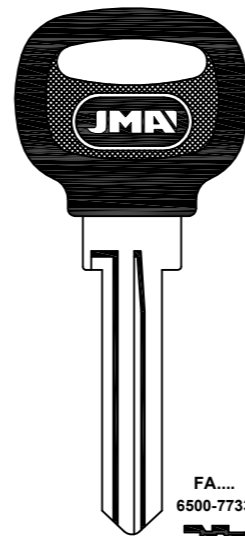

FA....
6500-7733



FO-14D.P

FOR: FORD®

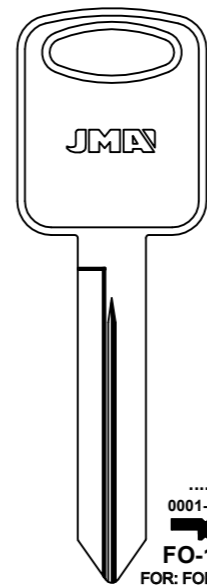

....X
0001-1706



FO-15D

FOR: FORD®

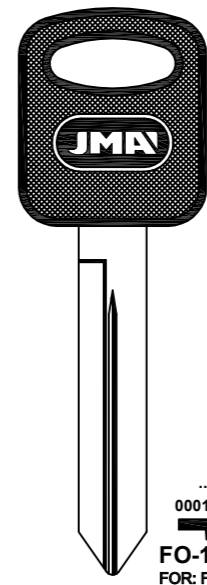

....X
0001-1706



FO-15D.P

FOR: FORD®

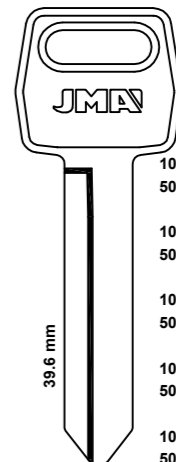

39.6 mm

A
101-291
501-579
B
101-332
501-602
C
101-344
501-624
D
101-327
501-602
E
101-296
501-579
FA
6500-7733

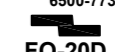

FO-20D

FOR: FORD®

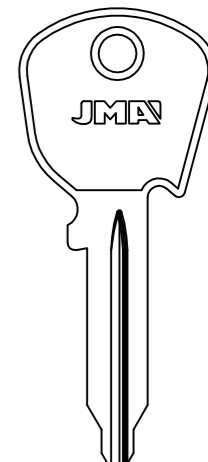

B-D-DV
01-64



FO-D

FOR: FORD®
FOR: BRITAX® -KOLB®

FOR: MERCEDES®

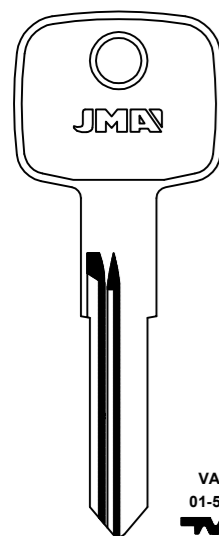

VA
01-50



ME-VA

FOR: HUF®
FOR: CASI®

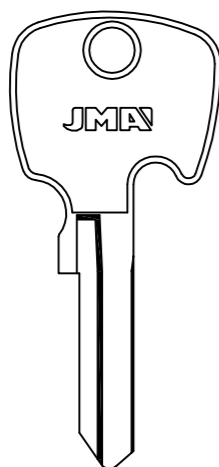

D...
1-2-3-4-5



NE-61D

FOR: NEIMAN®

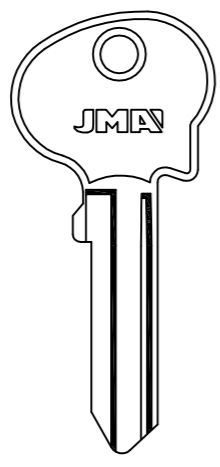

8...
1-2-3-4-5



NE-62

FOR: NEIMAN®

LAT.

FOR: MERCURY®

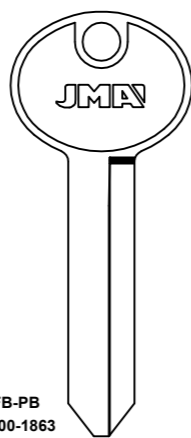

FB-PB
0000-1863



FO-1

FOR: FORD®

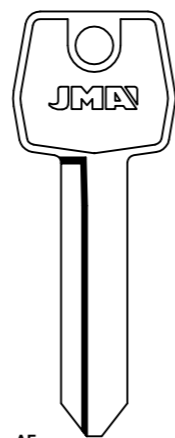

AF
0001-2600
FA-PA
0000-1863



FO-2

FOR: FORD®

FO-3

FOR: FORD®

FO-3D

FOR: FORD®

FOR: MERCURY®

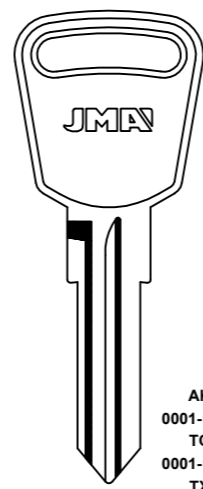

AK
0001-1000



FO-E/TC

FOR: FORD®
FOR: CASI® -CEM® -CLAUSOR® -KOLB® -NEIMAN®

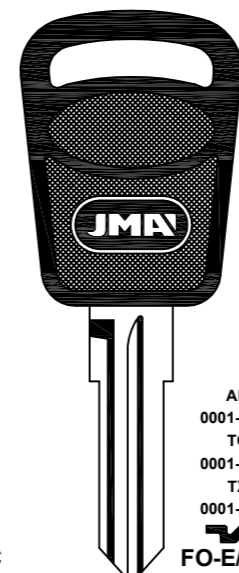

AK
0001-1000



FO-E/TC.P

FOR: FORD®

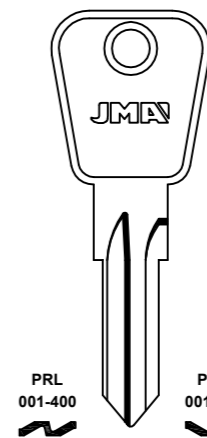

PRL
001-400



FO-PRL

FOR: FORD®

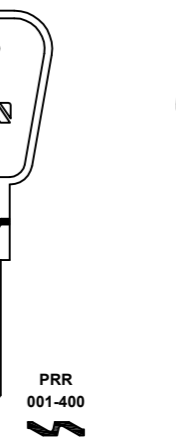

PRR
001-400



FO-PRR

FOR: FORD®

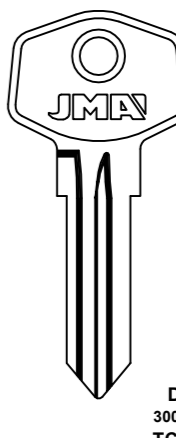

DM
300-400



FO-TC

FOR: FORD®
FOR: CASI® -CEM® -KOLB®

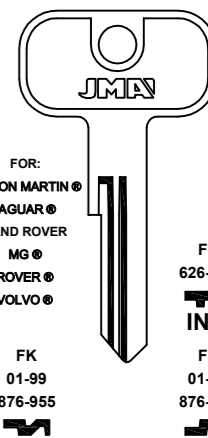

FOR:
ASTON MARTIN®
JAGUAR®
LAND ROVER
MG®
ROVER®
VOLVO®

FP
626-750



IN-1

FS
01-99



IN-4

FR
51-875



JN-4

FOR: UNION®

FOR: MERCURY®

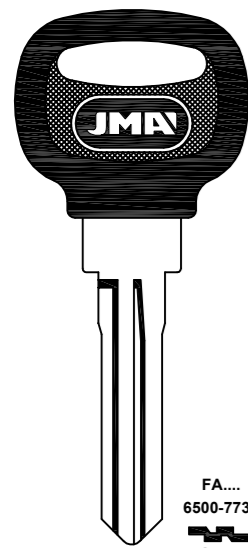

FA....
6500-7733



FO-7.P

FOR: FORD®

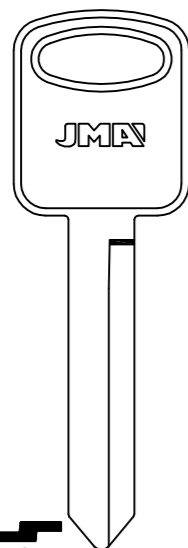

FO-8

FOR: FORD®

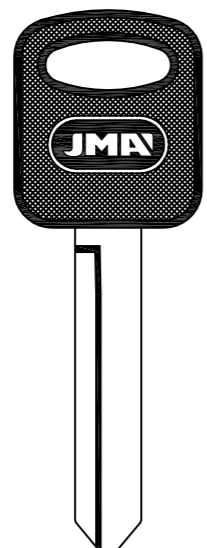

A
101-291
501-579
B
101-332
501-602
C
101-344
501-624
D
101-327
501-602
E
101-296
501-579



FO-8D

FOR: FORD®

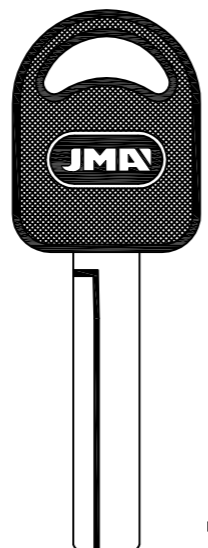

A
101-291
501-579
B
101-332
501-602
C
101-344
501-624
D
101-327
501-602
E
101-296
501-579



FO-8D.P

FOR: FORD®

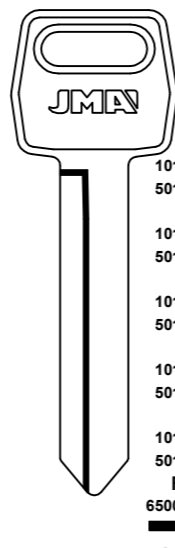

A
101-291
501-579
B
101-332
501-602
C
101-344
501-624
D
101-327
501-602
E
101-296
501-579
FA
6500-7733



FO-11D

FOR: FORD®

FOR: MG®

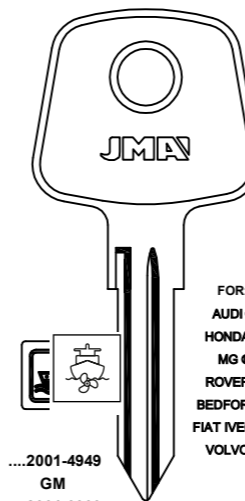

FOR:
AUDI®
HONDA®
MG®
ROVER®
BEDFORD®
FIAT IVECO®
VOLVO®

....2001-4949
GM



NE-1

FOR: NEIMAN®

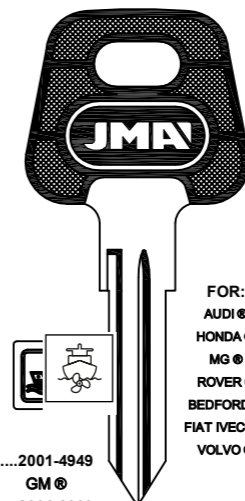

....2001-4949
GM



NE-1.P

FOR: NEIMAN®

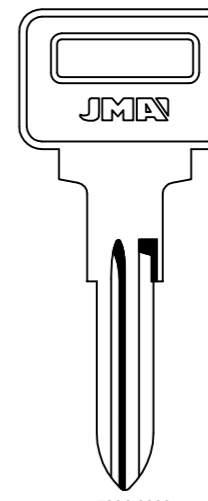

....7001-9000



NE-10

FOR: NEIMAN®

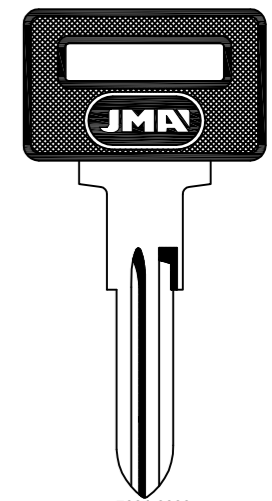

....7001-9000



NE-10.P

FOR: NEIMAN®

Concerning the marks and commercial denominations see legal warning.
Concerniente a las marcas y denominaciones comerciales ver aviso legal.
Marka eta izendapen komertzialiei dagokienez, ikus lege-oharra.
Concernant les marques et dénominations commerciales voir la note dans l'index.

JMA Opening the future

JMA Opening the future

Beziehen auf die marke und handelsname sehen sie die notiz im Impressum.
Relativamente às marcas e denominações comerciais, ver aviso legal.
Jeśli chodzi o znaki i nazwy handlowe, patrz Informacje prawne.



FOR: MG®

NRA
FFE...1-100
FJA...1-100
FL...251-500
NRA...51-90
YFB...1-75
FMD...1-75
FG...1-30
NF...1-30
EJR...1-75

FP...
626-750

UN-FFE
UN-3
UN-FP

MC...1-40
MRA...251-290
MRN...1-54
MRN...201-250
MRN...251-300

FR...
751-875

UN-MRN
UN-2
UN-FR

FS...1-99
FS...876-955

FA...
501-625

RM...
911-952

NGN...1-54

UN-1FS
UN-44
UN-44D
UN-NG

FOR: UNION®

FK...
01-99
876-955

FS...
01-99
876-955

UN-FK
UN-FS

FOR: UNION®
FOR: WBH®

FT-BC...301-360
BC-FT...101-225
LF...451-575
CB...801-875

TF...1001-1140

UN-FT
UN-TF

FOR: UNION®
FOR: CEM®

NH...
2001-3000

UN-NH

FOR: UNION®
FOR: CEM®

FOR: MITSUBISHI®

H
7001-8400
MIT-4
FOR: MITSUBISHI®

H
7001-8400
MIT-4.P
FOR: MITSUBISHI®

H
7001-9000
MIT-5
FOR: MITSUBISHI®

H
7001-9000
MIT-5.P
FOR: MITSUBISHI®

H
7001-9000
MIT-6
FOR: MITSUBISHI®

FOR: MICROCAR®

0111111
AL
628888

SIX-3.P
FOR: SIMPLEX®

FOR: MITSUBISHI®

E...
5001-7679

CHR-17
FOR: CHRYSLER®

Y
1001-2000

HY-3

X
1001-2000

HY-3D
FOR: HYUNDAI®

X
1001-2000

HY-3D.P1
FOR: HYUNDAI®

E
2001-3000

MIT-11
FOR: MITSUBISHI®

H
001-400
2221-2620
4441-4640
4641-5143

E
2001-3000

MIT-1D
FOR: MITSUBISHI®

FOR: MITSUBISHI®

H
7001-9000
MIT-6.P
FOR: MITSUBISHI®

E
5001-7000
MIT-7
FOR: MITSUBISHI®

E
5001-7000
7001-7679

MIT-15.P
FOR: MITSUBISHI®

30010-32009

MIT-8D
FOR: MITSUBISHI®

30010-32009

MIT-8D.P
FOR: MITSUBISHI®

FOR: MITSUBISHI®

H
001-400
2221-2620
4441-4640
4641-5143

E
2001-3000

MIT-11.P
FOR: MITSUBISHI®

H
001-400
2221-2620
4441-4640
4641-5143

E
2001-3000

MIT-1D.P
FOR: MITSUBISHI®

H
001-400
2221-2620
4441-4640
4641-5143

E
2001-3000

MIT-21
FOR: MITSUBISHI®

H
001-400
2221-2620
4441-4640
4641-5143

E
2001-3000

MIT-2D
FOR: MITSUBISHI®

H
001-400
2221-2620
4441-4640
4641-5143

E
2001-3000

MIT-21.P
FOR: MITSUBISHI®

H
001-400
2221-2620
4441-4640
4641-5143

E
2001-3000

MIT-2D.P
FOR: MITSUBISHI®

H
7001-8400

MIT-3
FOR: MITSUBISHI®

H
7001-8400

MIT-3.P
FOR: MITSUBISHI®

FOR: MITSUBISHI®

30010-32009

MIT-8D.P2
FOR: MITSUBISHI®

E
5001-7679

MIT-12
FOR: MITSUBISHI®

30010-32009

MIT-13D
FOR: MITSUBISHI®

30010-32009

MIT-14D
FOR: MITSUBISHI®

FOR: MOSKVITCH®

0 AL 3
LA-3D
FOR: LADA-MOSKVITCH®

Concerning the marks and commercial denominations see legal warning.
Concarniente a las marcas y denominaciones comerciales ver aviso legal.
Marka eta izendapen komertzialiei dagokienez, ikus lege-oharra.
Concernant les marques et denominations commerciales voir la note dans l'index.

JMA Opening the future

JMA Opening the future

Beziehen auf die marke und handelsname sehen sie die notiz im Impressum.
Relativamente às marcas e denominações comerciais, ver aviso legal.
Jeśli chodzi o znaki i nazwy handlowe, patrz Informacje prawne.

FOR: MOSKVITCH®

.....
0 AL 3
LA-3D.P
FOR: LADA-MOSKVITCH®

JMA
MOS-1
FOR: MOSKVITCH®

.....A/Z
A/Z.....
A/Z.....A/Z
1 AL 7
.....A/Z
0 AL 9
NE-3
FOR: NEIMAN®
FOR: CLAUSOR®

TALBOT SIMCA®
ZAZ®
DAF®
VOLVO®

FOR: EBRO®
FIAT®
LADA VAZ®
MOSKVITCH®
PEUGEOT®
RENAULT®

.....A/Z
A/Z.....
A/Z.....A/Z
1 AL 7
.....A/Z
0 AL 9
NE-3D
FOR: NEIMAN®
FOR: CLAUSOR®

TALBOT SIMCA®
ZAZ®
DAF®
VOLVO®

FOR: EBRO®
FIAT®
LADA VAZ®
MOSKVITCH®
PEUGEOT®
RENAULT®

.....A/Z
A/Z.....
A/Z.....A/Z
1 AL 7
.....A/Z
0 AL 9
NE-3.P
FOR: NEIMAN®
FOR: CLAUSOR®

TALBOT SIMCA®
ZAZ®
DAF®
VOLVO®

FOR: EBRO®
FIAT®
LADA VAZ®
MOSKVITCH®
PEUGEOT®
RENAULT®

.....A/Z
A/Z.....
A/Z.....A/Z
1 AL 7
.....A/Z
0 AL 9
NE-3.P1
FOR: NEIMAN®
FOR: CLAUSOR®

TALBOT SIMCA®
ZAZ®
DAF®
VOLVO®

FOR: NISSAN®

EBRO®
FIAT®
LADA VAZ®
MOSKVITCH®
PEUGEOT®
RENAULT®
TALBOT SIMCA®
ZAZ®
DAF®
VOLVO®

.....A/Z
A/Z.....
A/Z.....A/Z
1 AL 7
.....A/Z
0 AL 9
NE-3.P2
FOR: NEIMAN®
FOR: CLAUSOR®

VOL-2
VOL-2D

VOL-3
FOR: VOLGA®
FOR: GAZ®-ZAZ®

F
0001-1000
1001-2000
M
4001-5000
DAT-11

M
0001-1000
5001-6000
N
1001-2000
DAT-1D

M
6001-7000
W
0001-1000
DAT-21

M
0001-1000
7001-8000
M
DAT-2D

FOR: NISSAN®
FOR: DATSUN®-WASO®

FOR: NISSAN®

F
0001-1000
1001-2000
M
4001-5000
DAT-11.P

M
0001-1000
5001-6000
N
1001-2000
DAT-1D.P

M
6001-7000
W
0001-1000
DAT-21.P

M
7001-8000
M
DAT-2D.P

FOR: NISSAN®
FOR: DATSUN®-WASO®

001-150
601-900
3-7
DAT-31

001-150
601-900
4-8
DAT-3D

001-150
601-900
1-5
DAT-41

001-150
601-900
6-9
DAT-4D

VH
0001-3948
K
00001-14000
DAT-5D

FOR: NISSAN®
FOR: DATSUN®-WASO®

FOR: NISSAN®

X
0001-8000
DAT-6

Y
0001-8000
8001-9000
DAT-7

FOR: NISSAN®
FOR: DATSUN®

X
0001-8000
DAT-6D

Y
0001-8000
8001-9000
DAT-7.P

FOR: NISSAN®
FOR: DATSUN®

FOR: NISSAN®

X
0001-8000
DAT-6.P1

Y
0001-8000
8001-9000
DAT-7.P1

FOR: NISSAN®
FOR: DATSUN®

F
0001-1000
1001-2000
M
4001-5000
DAT-81

M
0001-1000
5001-6000
N
1001-2000
DAT-8

M
6001-7000
7001-800
W
0001-1000
DAT-91

M
7001-800
M
4001-5000
DAT-9D

F
0001-1000
1001-2000
M
4001-5000
DAT-81.P1

FOR: NISSAN®
FOR: DATSUN®

FOR: NISSAN®

F
0001-1000
1001-2000
M
4001-5000
DAT-81.P

M
6001-7000
7001-800
W
0001-1000
DAT-91.P

FOR: NISSAN®
FOR: DATSUN®

M
0001-1000
5001-6000
N
1001-2000
DAT-8.P

M
7001-800
M
4001-5000
DAT-9D.P

X
0001-9000
DAT-10

X
0001-9000
DAT-10.P

FOR: NISSAN®

VH
0001-3948
K
00001-14000
DAT-11

VH
0001-3948
K
00001-14000
DAT-11D

FOR: NISSAN®
FOR: DATSUN®-WASO®

Concerning the marks and commercial denominations see legal warning.
 Concerniente a las marcas y denominaciones comerciales ver aviso legal.
 Marka eta izendapen komertzialiei dagokienez, ikus lege-oharra.
 Concernant les marques et denominations commerciales voir la note dans l'index.

JMA Opening the future

JMA Opening the future

Beziehen auf die marke und handelsname sehen sie die notiz im Impressum.
 Relativamente às marcas e denominações comerciais, ver aviso legal.
 Jeśli chodzi o znaki i nazwy handlowe, patrz Informacje prawne.

FOR: NISSAN®

VH
0001-3948
K
00001-14000
DAT-11.P
FOR: NISSAN®
FOR: DATSUN® -WASO®

X
0001-9000
DAT-12
FOR: NISSAN®

Y
....1-8000
DAT-13
FOR: NISSAN®

Y
....1-8000
DAT-14.P
FOR: NISSAN®

1-22185
DAT-15
FOR: NISSAN®

FOR: NISSAN®

1-22185
DAT-15.P
FOR: NISSAN®

....1-22185
DAT-15.P4
FOR: NISSAN®

1-22185
DAT-16
FOR: NISSAN®

DAT-17
FOR: NISSAN®

DAT-17D
FOR: NISSAN®

DAT-18
FOR: NISSAN®

LAT.

FOR: NISSAN®

A
101-291
501-579
B
101-332
501-602
C
101-344
501-624
D
101-327
501-602
E
101-296
501-579
DAT-19.P
FOR: NISSAN®

....X
0001-1706
DAT-20
FOR: NISSAN®

....X
0001-1706
DAT-20.P
FOR: NISSAN®

FO-8
FOR: FORD®

A
101-291
501-579
B
101-332
501-602
C
101-344
501-624
D
101-327
501-602
E
101-296
501-579
FO-8D
FOR: FORD®

A
101-291
501-579
B
101-332
501-602
C
101-344
501-624
D
101-327
501-602
E
101-296
501-579
FO-8D.P
FOR: FORD®

FOR: NISSAN®

A
101-291
501-579
B
101-332
501-602
C
101-344
501-624
D
101-327
501-602
E
101-296
501-579
FO-8D.P1
FOR: FORD®

NSP....
4000-4999
7001-9000
E....
2001-3000
4001-5000
S....
2001-3000
NE-11
FOR: NEIMAN®

NSP....
4000-4999
7001-9000
E....
2001-3000
4001-5000
S....
2001-3000
NE-11.P
FOR: NEIMAN®

FOR: NISSAN (AUSTRALIA)®

X
0001-8000
DAT-6.P
FOR: NISSAN®

DAT-6D.P
FOR: DATSUN®

Y
0001-8000
8001-9000
DAT-7.P
FOR: NISSAN®

X
0001-9000
DAT-12
FOR: NISSAN®

FOR: NISSAN (AUSTRALIA)®

X
0001-8000
DAT-6
FOR: NISSAN®

Y
0001-8000
8001-9000
DAT-7
FOR: DATSUN®

DAT-6D
FOR: DATSUN®

FOR: NISSAN (USA)®

F
0001-1000
1001-2000
M
4001-5000
DAT-11
FOR: NISSAN®

M
0001-1000
5001-6000
N
1001-2000
DAT-1D
FOR: NISSAN®

M
6001-7000
W
0001-1000
DAT-21
FOR: DATSUN® -WASO®

M
0001-1000
7001-8000
DAT-2D
FOR: DATSUN® -WASO®

FOR: NISSAN (USA)®

F
0001-1000
1001-2000
M
4001-5000
DAT-11.P
FOR: NISSAN®

M
0001-1000
5001-6000
N
1001-2000
DAT-1D.P
FOR: DATSUN® -WASO®

M
6001-7000
W
0001-1000
DAT-21.P
FOR: NISSAN®

M
0001-1000
7001-8000
DAT-2D.P
FOR: DATSUN® -WASO®

X
0001-8000
DAT-6
FOR: NISSAN®

Y
0001-8000
8001-9000
DAT-7
FOR: DATSUN®

DAT-6D
FOR: DATSUN®

Concerning the marks and commercial denominations see legal warning.
 Concerniente a las marcas y denominaciones comerciales ver aviso legal.
 Marka eta izendapen komertzialiei dagokienez, ikus lege-oharra.
 Concernant les marques et denominations commerciales voir la note dans l'index.

JMA Opening the future

JMA Opening the future

Beziehen auf die marke und handelsname sehen sie die notiz im Impressum.
 Relativamente às marcas e denominações comerciais, ver aviso legal.
 Jeśli chodzi o znaki i nazwy handlowe, patrz Informacje prawne.



FOR: NISSAN (USA)®

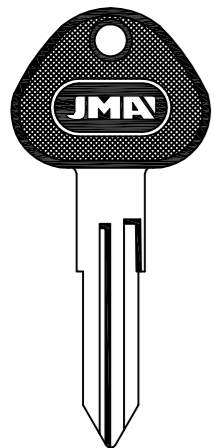

X
0001-8000
DAT-6.P DAT-6D.P

Y
0001-8000
8001-9000
DAT-7.P

FOR: NISSAN®
FOR: DATSUN®

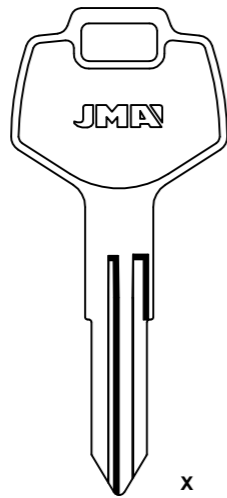

X
0001-9000
DAT-12

FOR: NISSAN®

FOR: NSU®

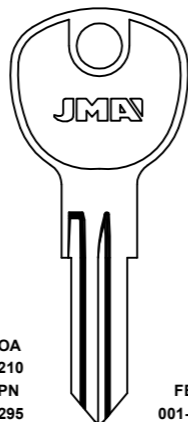

DA-OA
001-210
ER-PN
101-295
ER
001-195
ER
501-695
FO-OA

FB
001-210
PO
501-695
PO
101-295
FO-PN

FOR: FORD®
FOR: CASI® -HUF® -YMOS®

OL
001-210
07R
001-195
7OR
001-210
FO-OL

O7L
001-195
7OL
001-210
OR
001-210
FO-OR

FOR: CASI® -YMOS®

OB...
1-210
VO-7

FOR: OM IVECO®

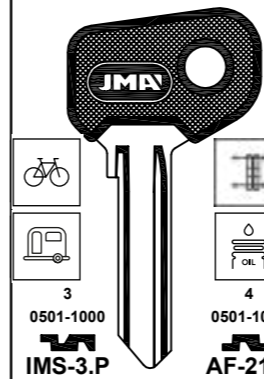

3
0501-1000
IMS-3.P

4
0501-1000
AF-21.P

1
0501-1000
IMS-5.P

2
0501-1000
AF-19.P

IMS-13.P

FOR: SAFE®
FOR: CROMODORA® -FIST® -IMSA®

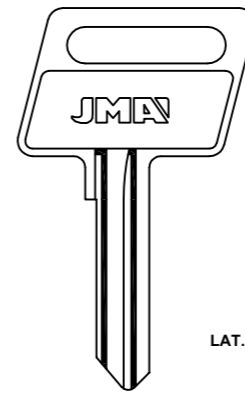

LAT.

1
0501-1000
IMS-12

FOR: IMSA®
FOR: SAFE®

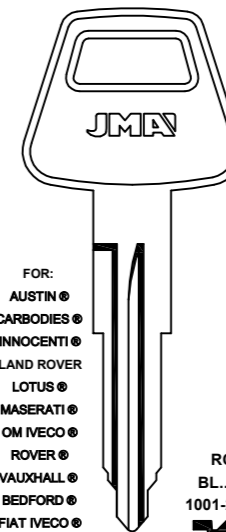

FOR:
AUSTIN®
CARBODIES®
INNOCENTI®
LAND ROVER
LOTUS®
MASERATI®
OM IVECO®
ROVER®
VAUXHALL®
BEDFORD®
FIAT IVECO®

FOR: L. & F.®

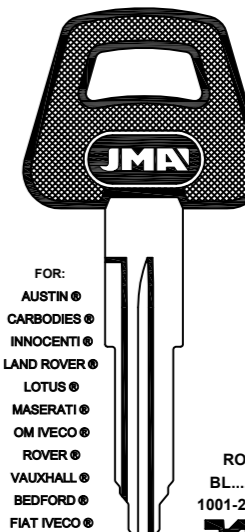

FOR:
AUSTIN®
CARBODIES®
INNOCENTI®
LAND ROVER
LOTUS®
MASERATI®
OM IVECO®
ROVER®
VAUXHALL®
BEDFORD®
FIAT IVECO®

FOR: L. & F.®

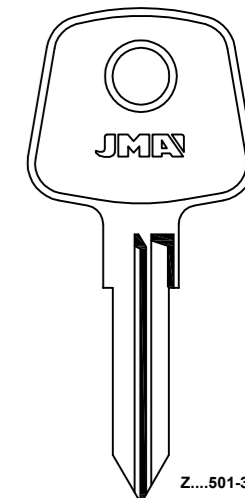

RO
BL...N
1001-2000
LF-RO

FOR: L. & F.®

Z...501-3278
P...501-3278
SIP-1

FOR: SIPEA®

FOR: OM IVECO®

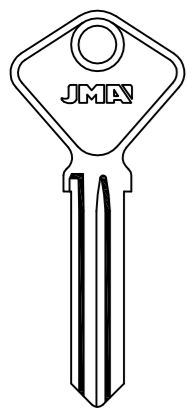

S
615-699
712-799
812-899
AF-4I

FOR: SAFE®
FOR: FIST® -TRAMA®

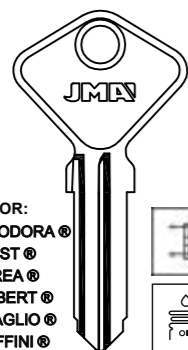

FOR:
CROMODORA®
FIST®
FREA®
GIOBERT®
MIRAGLIO®
RUFFINI®

6
100-309
AF-5I

2
100-309
AF-6I

FOR: SAFE®

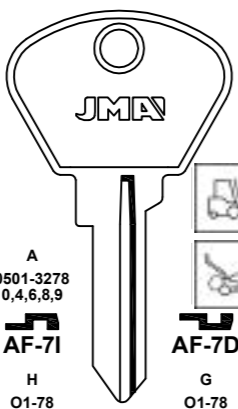

A
0501-3278
0,4,6,8,9
AF-7I

H
01-78
AF-8I

F
01-78
AF-9I

FOR: SIPEA®

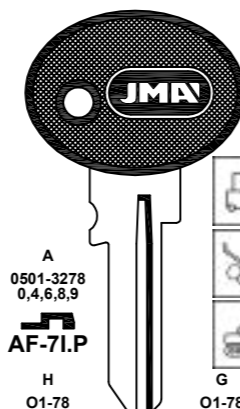

A
0501-3278
0,4,6,8,9
AF-7I.P

H
01-78
AF-8I.P

F
01-78
AF-9I.P

FOR: SIPEA®

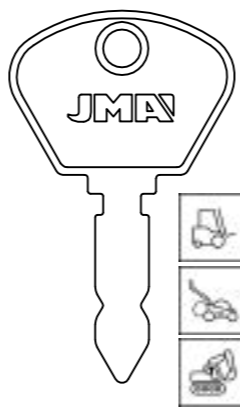

7,1
1,95
BH-4

FOR: BOSCH®
FOR: KOLB® -POLAR®

FOR: OM IVECO®

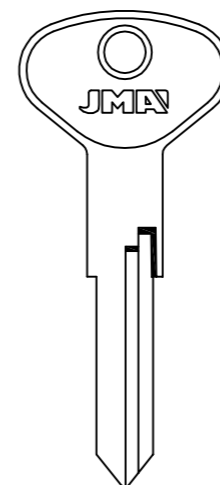

AH...
1-8154
1001-9282
VO-AH

HV...
1-8154
1001-9282
VO-HV

VB-NV-MD...
1-8154
1001-9282
VO-VB

N...
VO-N

FOR: HUF®
FOR: AKS® -CASI® -UBE® -WITTE®

AN...
001-854
1001-1918
2001-2830
3001-3890
4001-5151
6001-7086
7001-8154
8201-9282
AU-AN

FOR: OPEL-VAUXHALL®

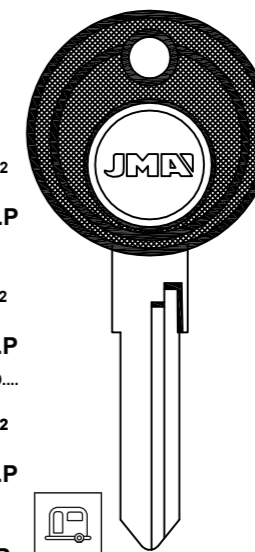

AH...
1-8154
1001-9282
VO-AH.P

HV...
1-8154
1001-9282
VO-HV.P

VB-NV-MD...
1-8154
1001-9282
VO-VB.P

N...
VO-N.P

FOR: HUF®
FOR: AKS® -CASI® -UBE® -WITTE®

AN...
001-854
1001-1918
2001-2830
3001-3890
4001-5151
6001-7086
7001-8154
8201-9282
AU-AN.P

DAC-4D.P
FOR: DACIA®

FOR: OM IVECO®

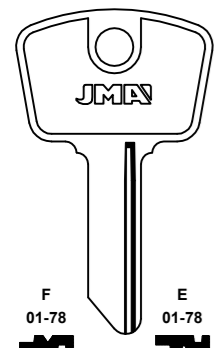

F
01-78
FEM-1I

H
01-78
FEM-2I

FEM-3I

FOR: FEMSA®

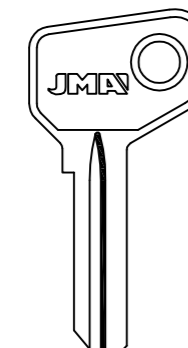

E
01-78
FEM-1D

G
01-78
FEM-2D

FI-4D

FOR: GIOBERT®
FOR: IACAM®

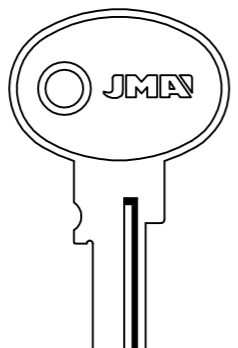

M
0001-1050
FI-9I

FOR: GIOBERT®

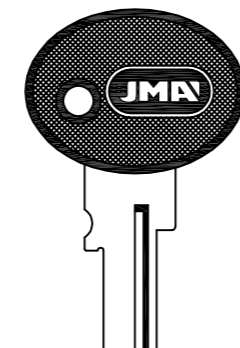

M
0001-1050
FI-9I.P

FOR: GIOBERT®

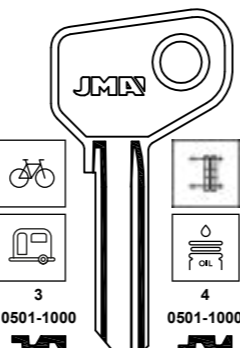

3
0501-1000
IMS-3

1
0501-1000
IMS-5

IMS-13

FOR: SAFE®
FOR: CROMODORA® -FIST® -IMSA®

4
0501-1000
AF-21

2
0501-1000
AF-19

FOR: OPEL-VAUXHALL®

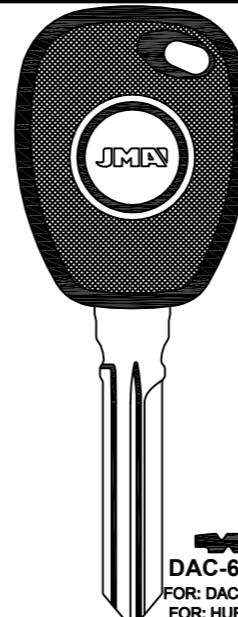

DAC-6D.P
FOR: DACIA®
FOR: HUF®

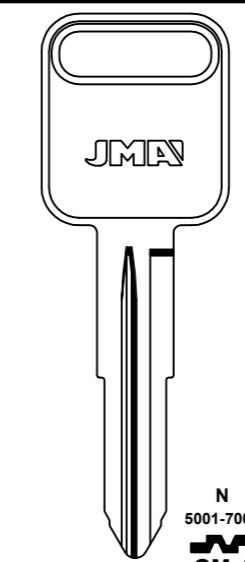

N
5001-7000
GM-4
FOR: G.M.®

FOR: BRIGGS STRATTON®

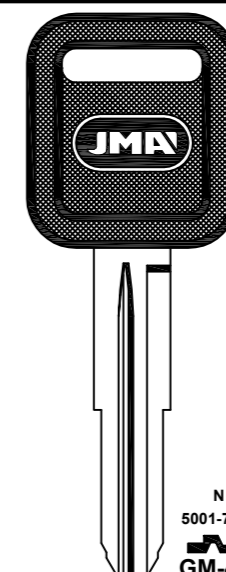

N
5001-7000
GM-4.P
FOR: G.M.®

FOR: BRIGGS STRATTON®

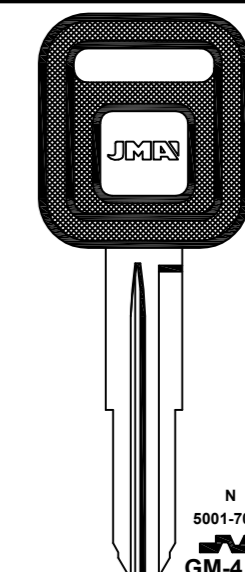

N
5001-7000
GM-4.P1
FOR: G.M.®

FOR: BRIGGS STRATTON®

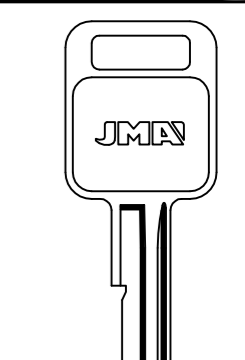

A
000-999
GM-6

E
000-999
GM-8

FOR: G.M.®

C
000-999
GM-7

J
000-999
GM-9

FOR: G.M.®

FOR: BRIGGS STRATTON®

Concerning the marks and commercial denominations see legal warning.
Concerniente a las marcas y denominaciones comerciales ver aviso legal.
Marka eta izendapen komertzialiei dagokienez, ikus lege-oharra.
Concernant les marques et denominations commerciales voir la note dans l'index.

JMA Opening the future

JMA Opening the future

Beziehen auf die Marke und Handelsname sehen sie die Notiz im Impressum.
Relativamente às marcas e denominações comerciais, ver aviso legal.
Jeśli chodzi o znaki i nazwy handlowe, patrz Informacje prawne.

FOR: OPEL-VAUXHALL ®

SR
001-240
KSR
001-240
LSR
001-240
TSR
001-240
HU-SR

SU
001-240
401-630
HU-SU
SX
001-240
HU-SX
SY
001-240
HU-SY

SZ
1-240
HU-SZ

A 000-999 GM-6.P
C 000-999 GM-7.P
A 000-999 GM-A
C 000-999 GM-C
A 000-999 GM-E.P
C 000-999 GM-J.P
E 000-999 GM-8.P
J 000-999 GM-9.P
E 000-999 GM-E
J 000-999 GM-J
E 000-999 GM-E.P
J 000-999 GM-J.P
SE 001-750
SC 401-630
HU-SC
FOR: G.M. ®
FOR: BRIGGS STRATTON ®
FOR: G.M. ®
FOR: BRIGGS STRATTON ®
FOR: G.M. ®
FOR: BRIGGS STRATTON ®
FOR: HUF ®
FOR: AKS ®

FOR: OPEL-VAUXHALL ®

G...1-250
G...1251-1500
OP-HG
H...1-250
H...1251-1500
OP-HH
J...
1-2874
OP-J
J...
1-2874
OP-J.P
R...
1-1500
OP-R
R...
1-1500
OP-R.P
FOR: HUF ®
FOR: YMOS ®
FOR: HUF ®
FOR: YMOS ®
FOR: HUF ®
FOR: YMOS ®
FOR: HUF ®
FOR: YMOS ®

FOR: OPEL-VAUXHALL ®

H 7001-8400
MIT-3
FOR: MITSUBISHI ®

H 7001-8400
MIT-3.P
FOR: MITSUBISHI ®

6 001-250
OP-6
7 001-250
OP-7
8 001-250
OP-8
9 001-250
OP-9
AB... 1-1000
OP-AB
BA... 1-1000
OP-BA
AB... 1-1000
OP-AB.P
BA... 1-1000
OP-BA.P
FOR: HUF ®
FOR: YMOS ®
FOR: HUF ®
FOR: YMOS ®
FOR: HUF ®
FOR: YMOS ®
FOR: HUF ®
FOR: YMOS ®

FOR: OPEL-VAUXHALL ®

S... 1-5200
OP-S.P1
FOR: HUF ®

T... 1-500
501-1500
OP-T
FOR: HUF ®
FOR: YMOS ®

T... 1-500
501-1500
OP-T.P
FOR: HUF ®
FOR: YMOS ®

H...
WH...
0001-3000
LAT.
FOR:
ASTON MARTIN ®
GM ®
HOLDEN ®
IRMSCHER ®
OPEL ®
VAUXHALL ®
7.18
2.95
OP-WH.P
WY...
Y...
0001-3000
6.88
2.95
OP-WY.P
FOR: HUF ®
FOR: YMOS ®

FOR: PEUGEOT ®

FOR:
A.MOTORS
CITROEN ®
MAZDA ®
PEUGEOT ®
RENAULT ®
TALBOT
DAF ®
NISSAN ®
PEGASO ®
.....
A/Z
B-C-D-E
1/9...A/Z
1/9...A/Z
.....A/Z
B-D-E-G-H-J
1/9...A/Z
1/9...A/Z
E-M-N-P-R
CHR-3
FOR: CHRYSLER ®
FOR: CLAUSOR ®-NEIMAN ®

FOR: OPEL-VAUXHALL ®

CC...501-1000
CC...1751-2000
CC...2501-3000
OP-CC
DD...501-1000
DD...1751-2000
DD...2501-3000
OP-DD
B...1-380
BB...501-1000
BB...1751-2000
BB...2501-3000
OP-BB
EE...501-1000
EE...1751-2000
EE...2501-3000
OP-EE
FF...501-1000
FF...1751-2000
FF...2501-3000
OP-FF
D 1-5200
OP-D
S... 1-5200
OP-S
FOR: HUF ®
FOR: YMOS ®
D 1-5200
OP-D.P
S... 1-5200
OP-S.P
FOR: HUF ®
FOR: YMOS ®
A... 1-500
OP-NA
B... 1-500
OP-NB
FOR: HUF ®
FOR: YMOS ®

FOR: PEUGEOT ®

.....
A/Z
B-C-D-E
1/9...A/Z
1/9...A/Z
.....A/Z
B-D-E-G-H-J
1/9...A/Z
1/9...A/Z
E-M-N-P-R
CHR-3.P
FOR: CHRYSLER ®
FOR: CLAUSOR ®-NEIMAN ®

FOR:
A.MOTORS
CITROEN ®
MAZDA ®
PEUGEOT ®
RENAULT ®
TALBOT
DAF ®
NISSAN ®
PEGASO ®
CHR-4I
CHR-4D
RO-1IS
RO-1DS
C 001-224
RO-3
FOR: RONIS ®

6 100-517
FAR-1I
2 100-517
FAR-2I
H 100-309
FAR-3
8 100-517
FAR-1D
4 100-517
FAR-2D
FOR: FARMA ®
FOR: FISAM ®
6 100-517
FAR-3D
8 100-517
FAR-4D
FOR: FARMA ®
FOR: FISAM ®

Z-GR
7001-9956
FI-2D
G
2001-4530
G-Z
7001-9956
FI-3D
G
7001-9956
FI-12
FOR: GIOBERT ®

Concerning the marks and commercial denominations see legal warning.
Concerniente a las marcas y denominaciones comerciales ver aviso legal.
Marka eta izendapen komertzialiei dagokienez, ikus lege-oharra.
Concernant les marques et denominations commerciales voir la note dans l'index.

JMA Opening the future

JMA Opening the future

Beziehen auf die Marke und Handelsname sehen sie die Notiz im Impressum.
Relativamente às marcas e denominações comerciais, ver aviso legal.
Jeśli chodzi o znaki i nazwy handlowe, patrz Informacje prawne.

FOR: PEUGEOT®

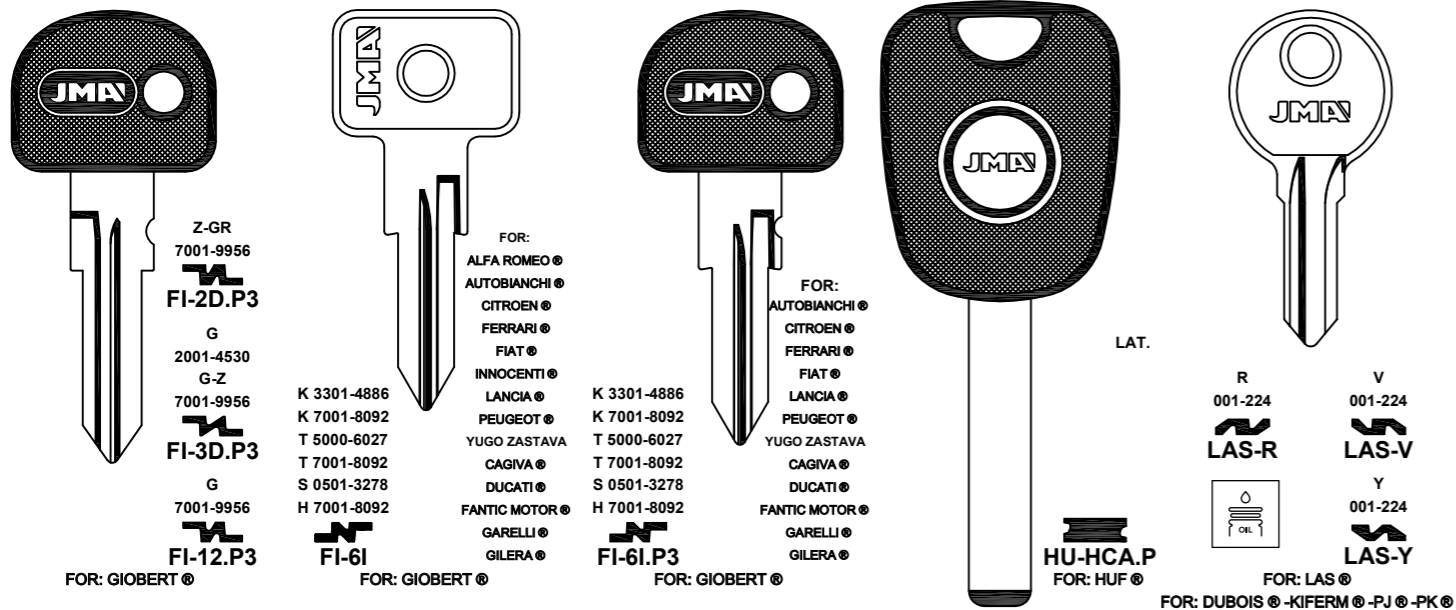

FOR: PEUGEOT®

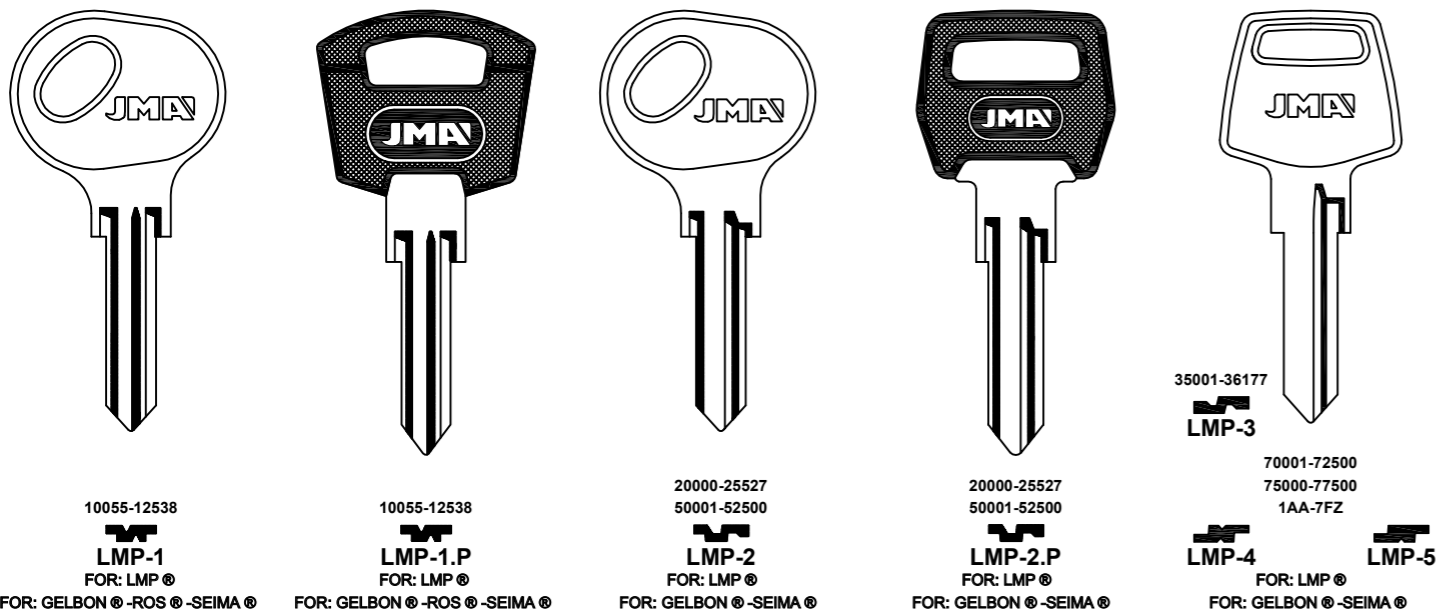

FOR: PEUGEOT®

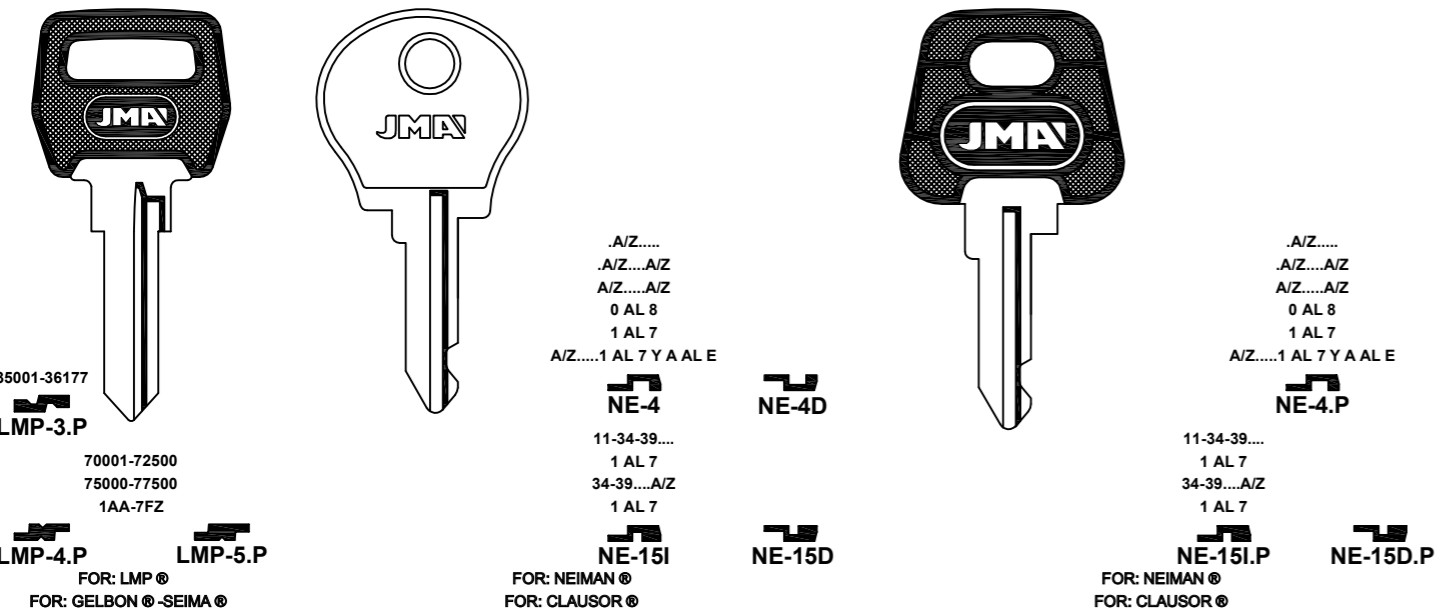

FOR: PEUGEOT®

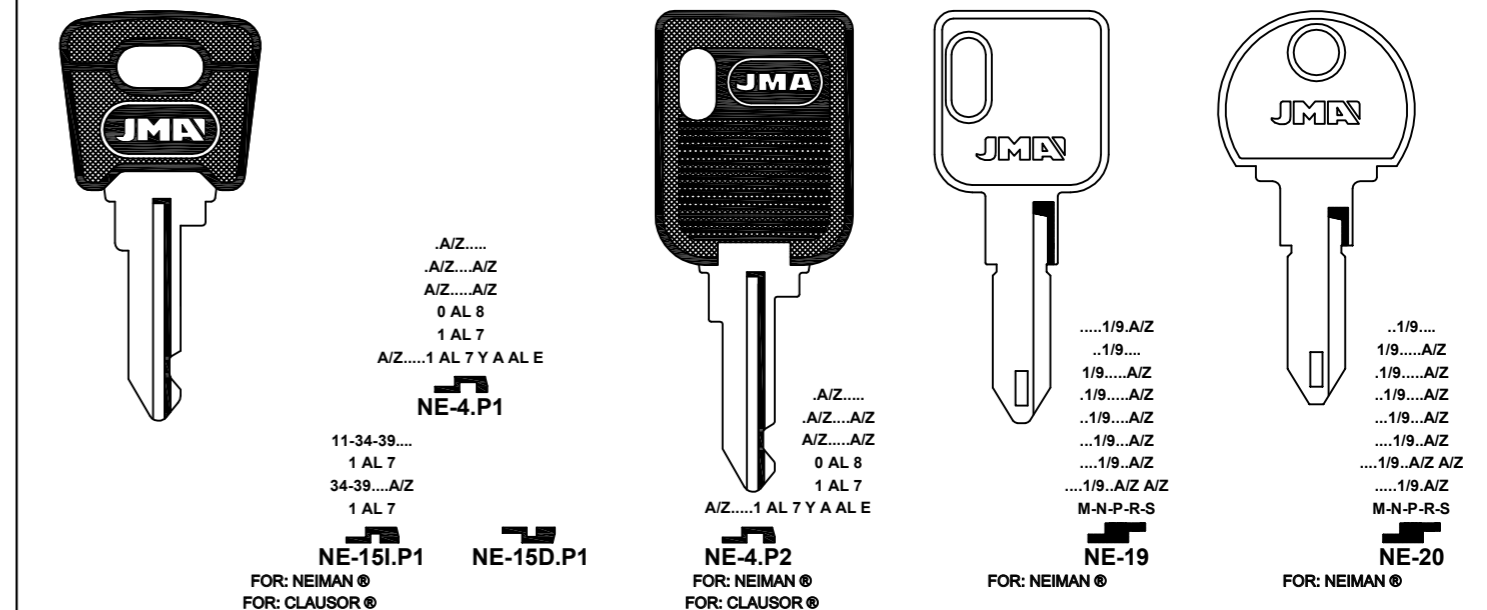

FOR: PEUGEOT®

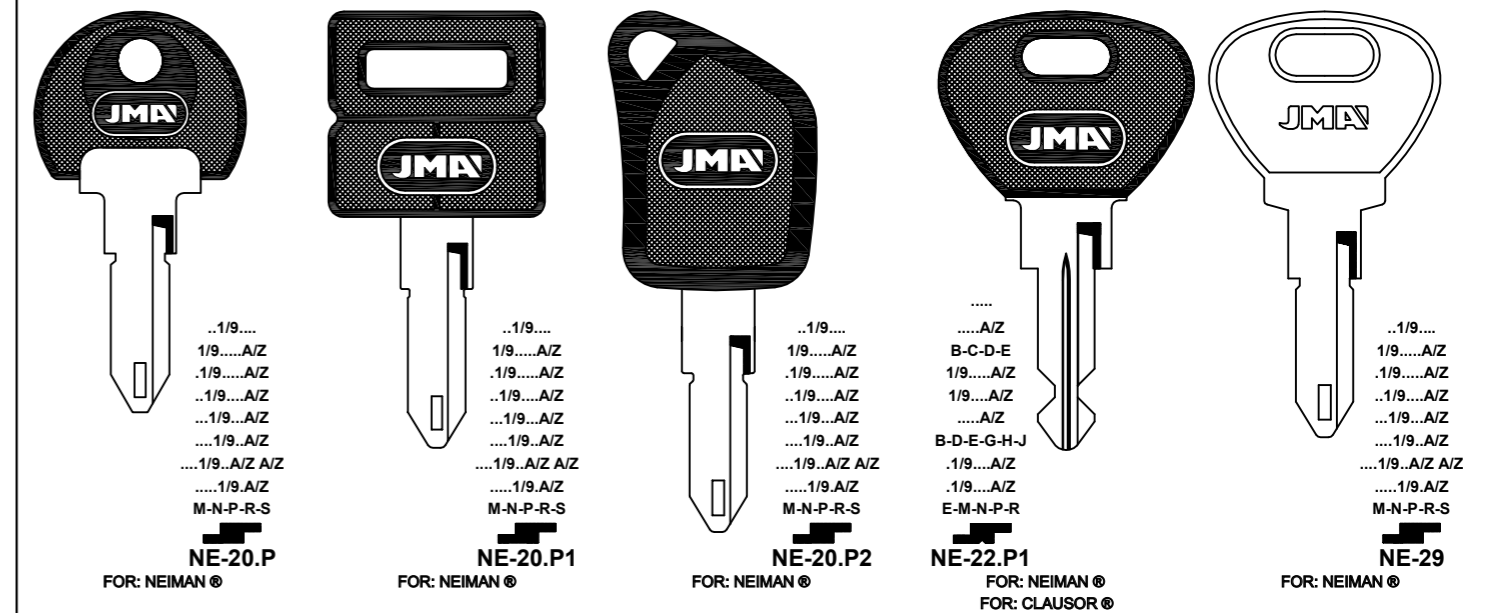

FOR: PEUGEOT®

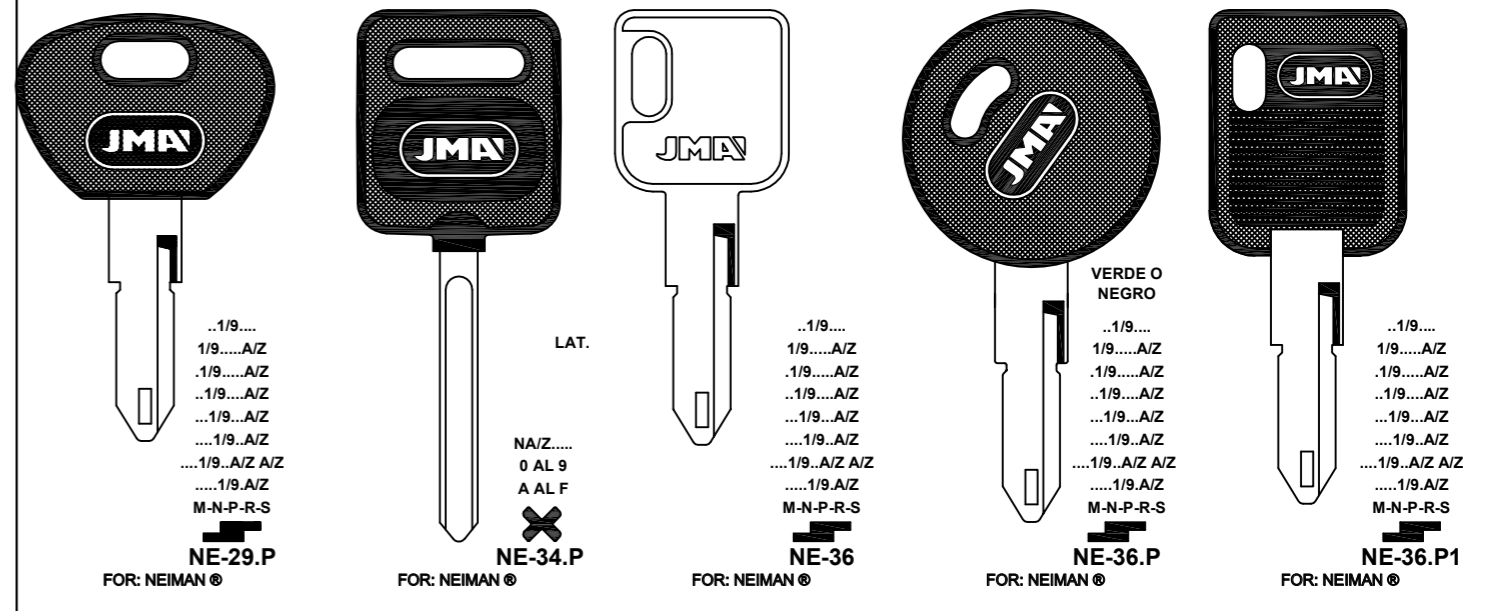

Concerning the marks and commercial denominations see legal warning.
Concerniente a las marcas y denominaciones comerciales ver aviso legal.
Marka eta izendapen komertzialiei dagokienez, ikus lege-oharra.
Concernant les marques et dénominations commerciales voir la note dans l'index.

JMA Opening the future

JMA Opening the future

Beziehen auf die marke und handelsname sehen sie die notiz im Impressum.
Relativamente às marcas e denominações comerciais, ver aviso legal.
Jeśli chodzi o znaki i nazwy handlowe, patrz Informacje prawne.

FOR: PEUGEOT (ARGENTINA) ®

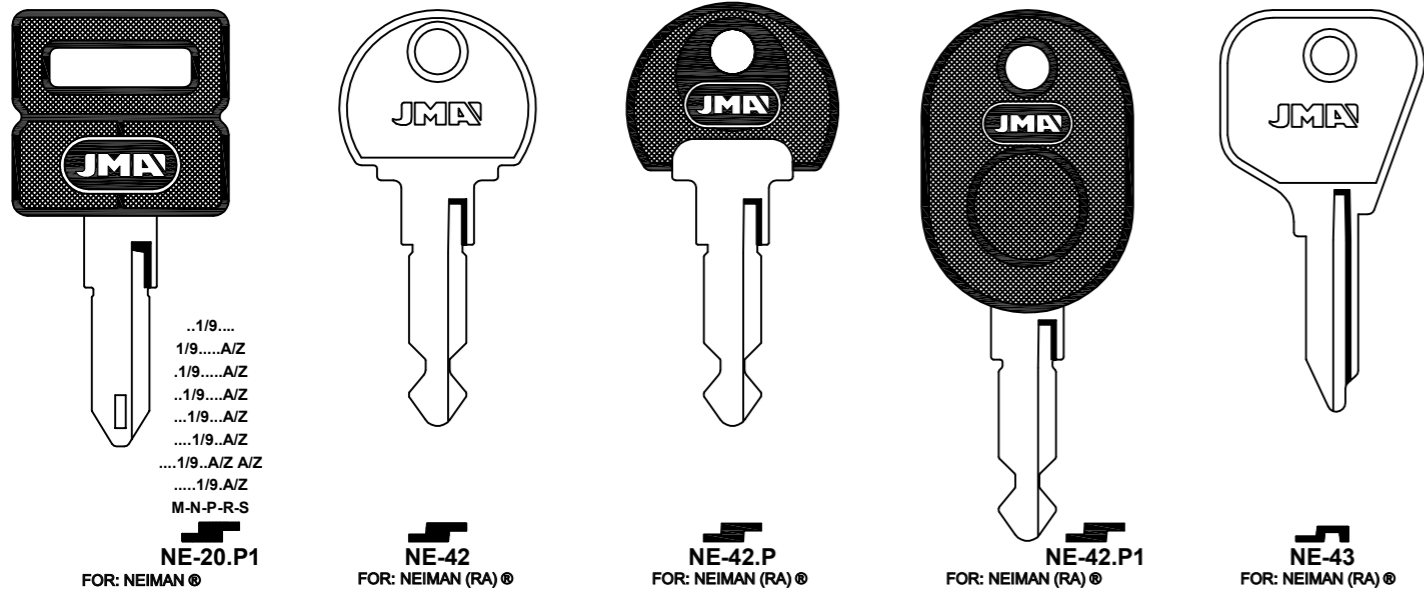

FOR: PLYMOUTH ®

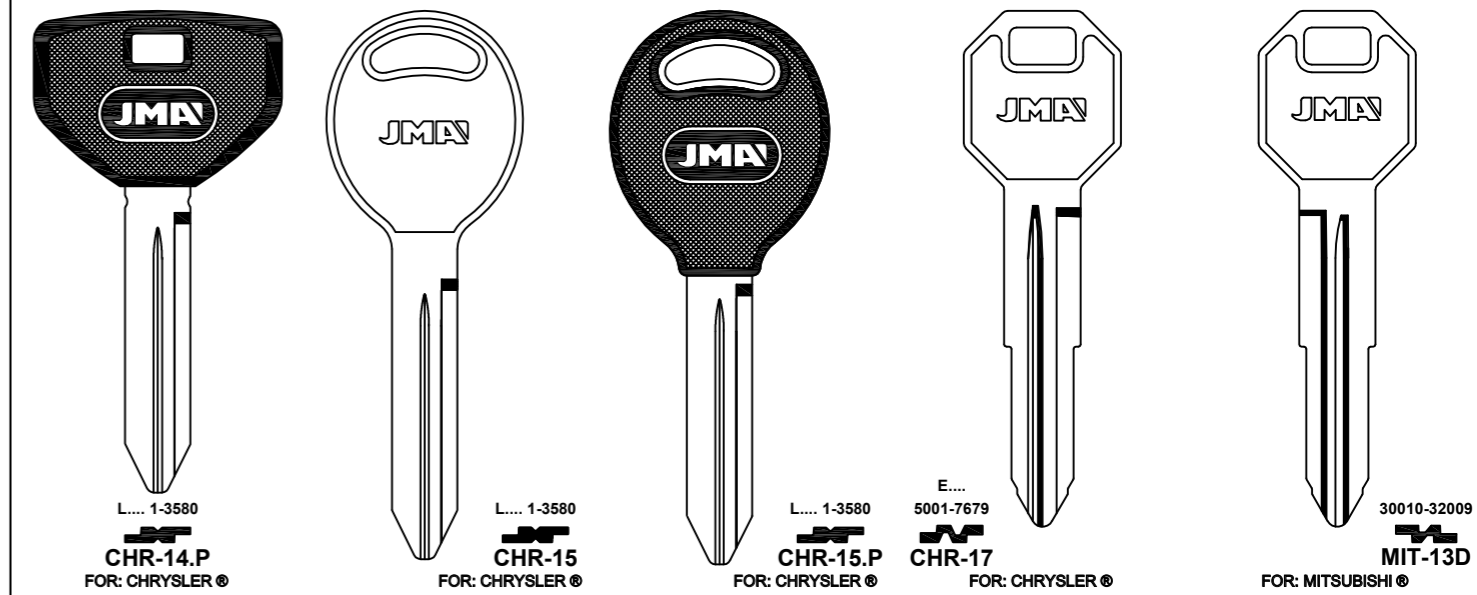

FOR: PEUGEOT (ARG.) ®

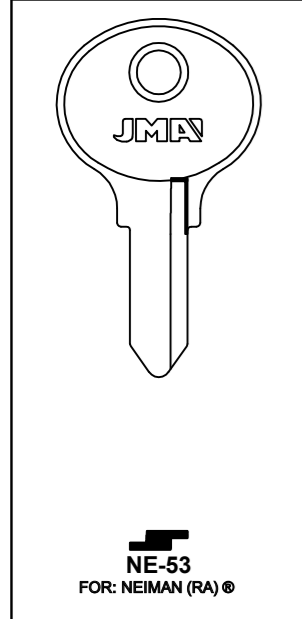

FOR: PIAGGIO ®

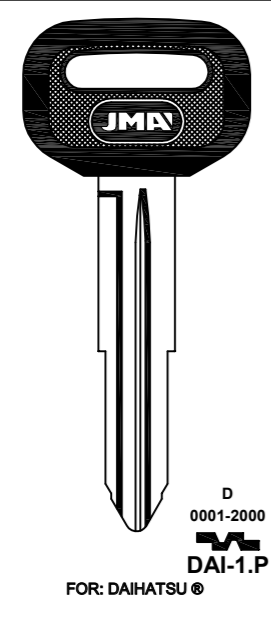

FOR: PLYMOUTH ®

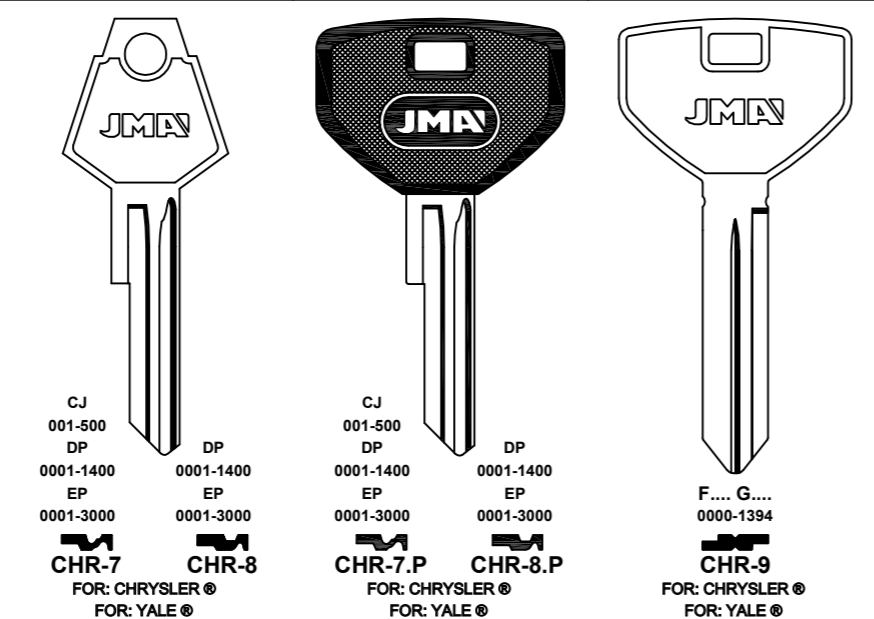

FOR: PLYMOUTH ®

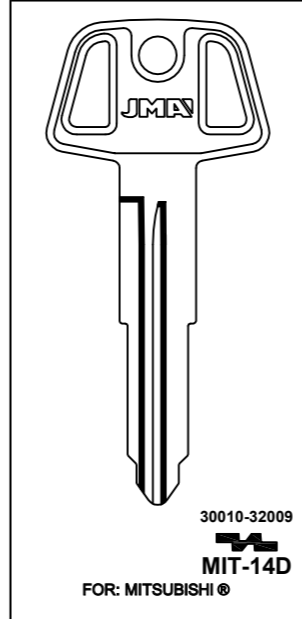

FOR: PORSCHE ®

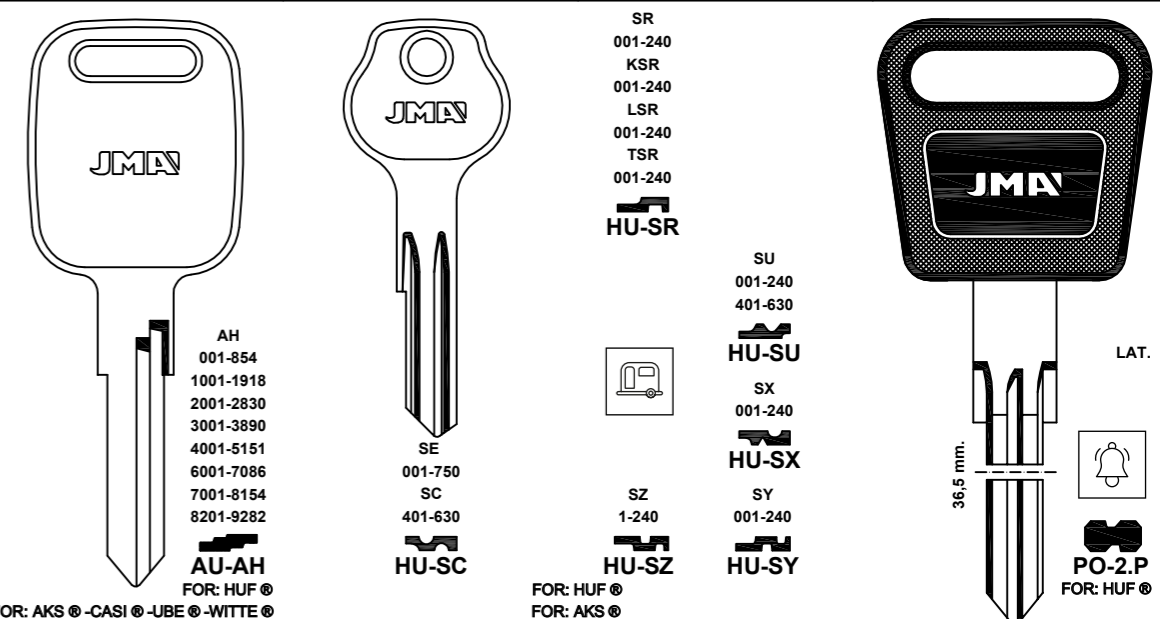

FOR: PLYMOUTH ®

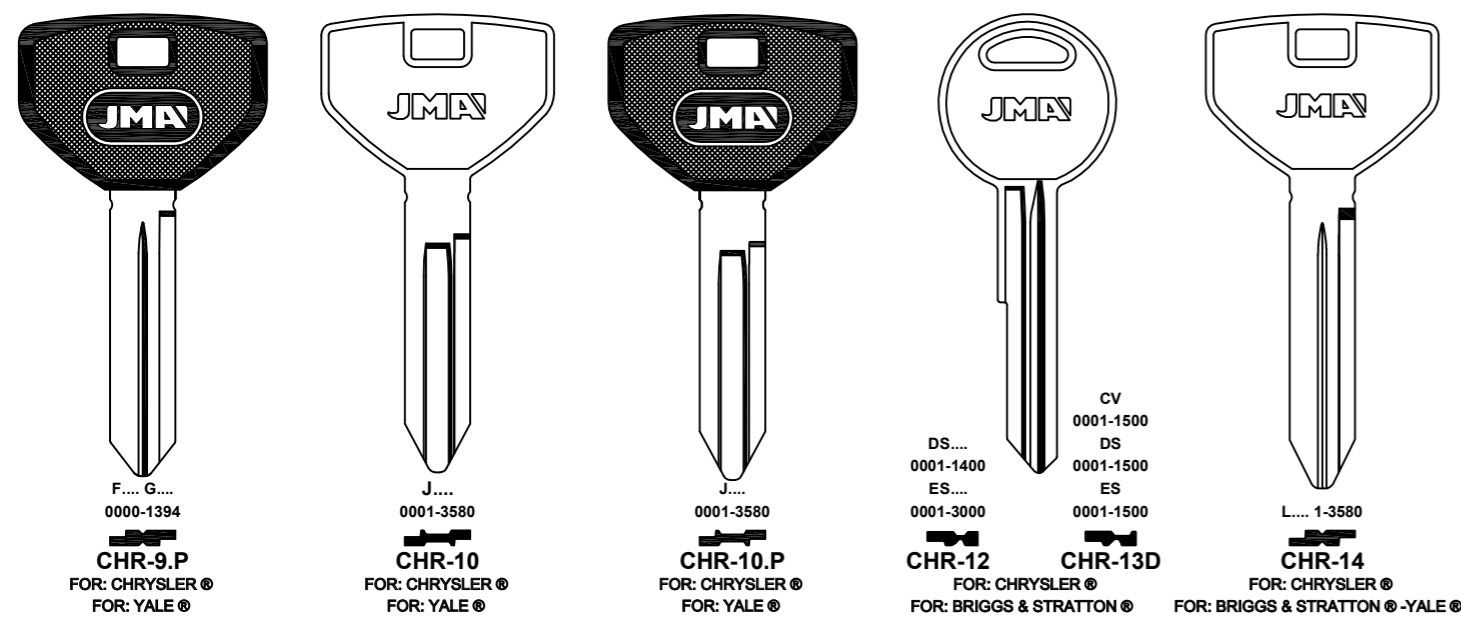

FOR: PORSCHE ®

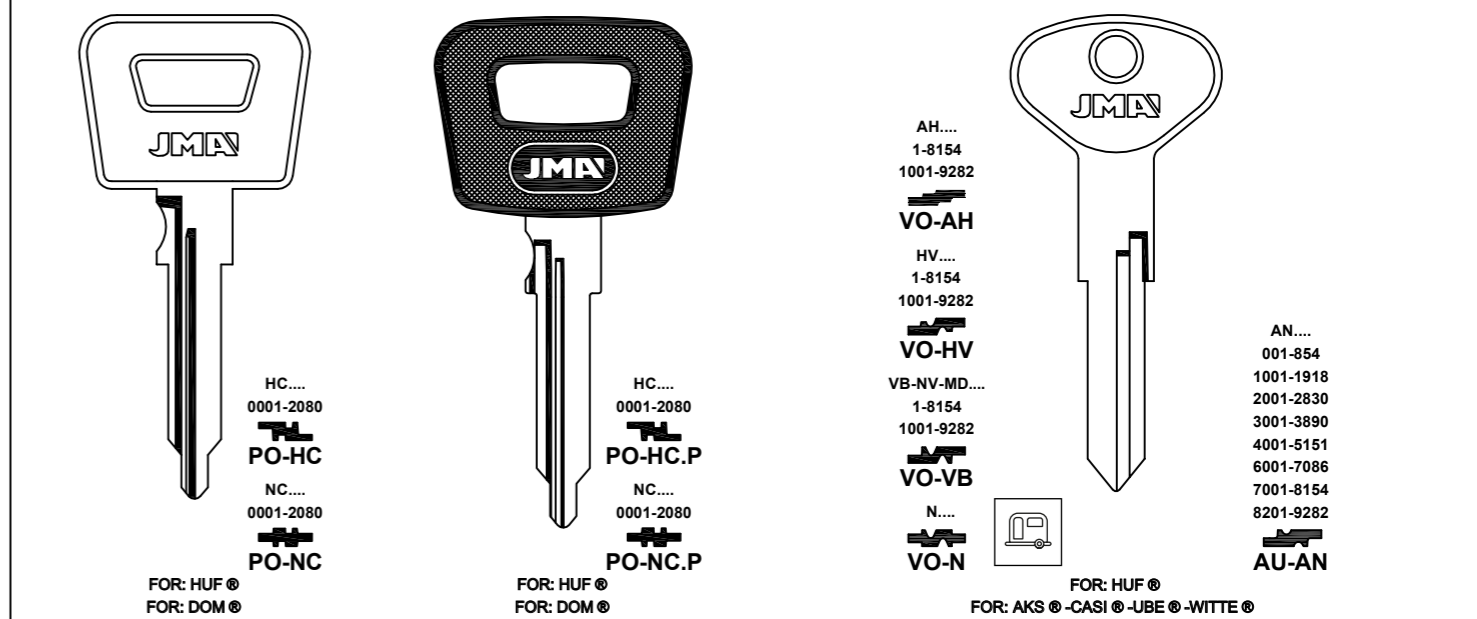

Concerning the marks and commercial denominations see legal warning.
Concerniente a las marcas y denominaciones comerciales ver aviso legal.
Marka eta izendapen komertzialiei dagokienez, ikus lege-oharra.
Concernant les marques et denominations commerciales voir la note dans l'index.



Beziehen auf die marke und handelsname sehen sie die notiz im Impressum.
Relativamente às marcas e denominações comerciais, ver aviso legal.
Jeśli chodzi o znaki i nazwy handlowe, patrz Informacje prawne.

FOR: ALFA ROMEO®

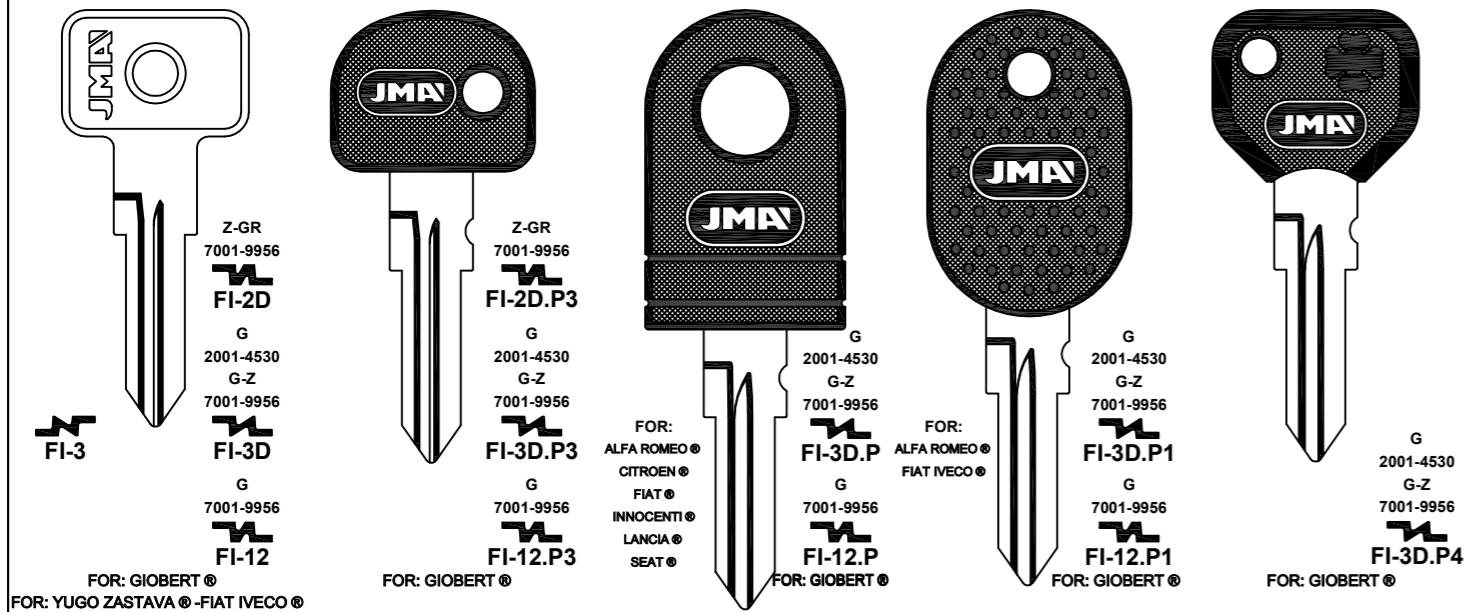

FOR: ALFA ROMEO®

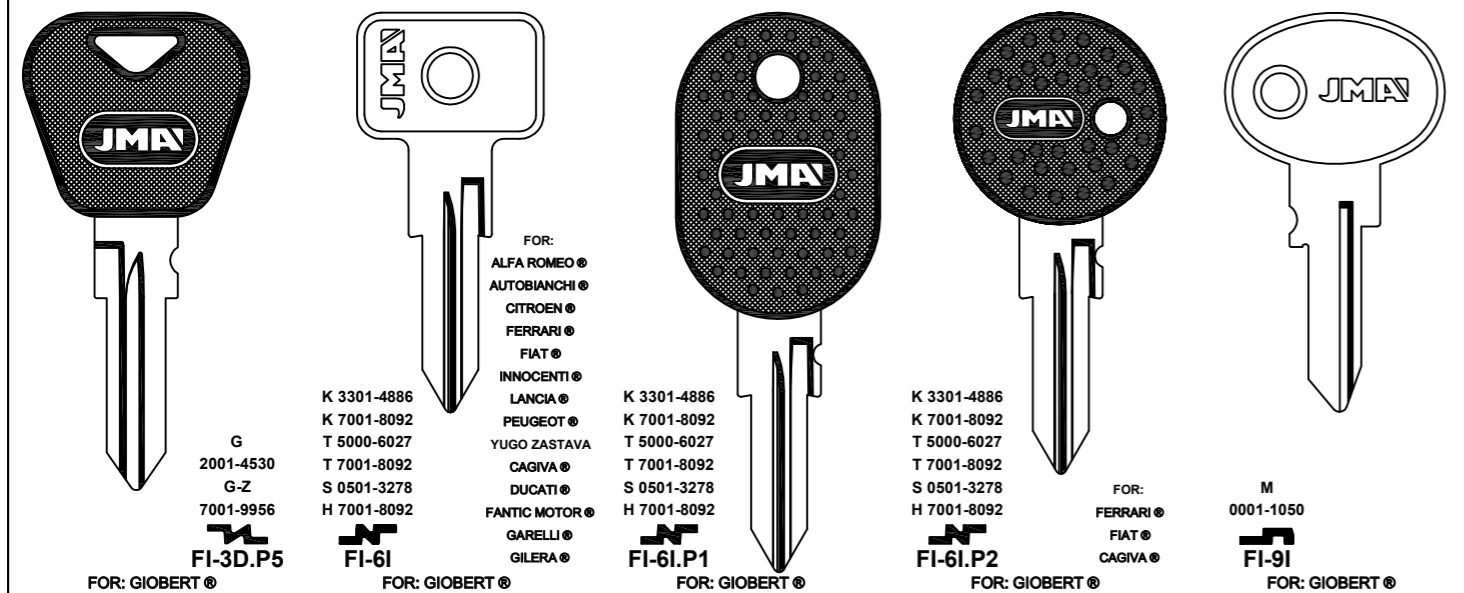

FOR: ALFA ROMEO®

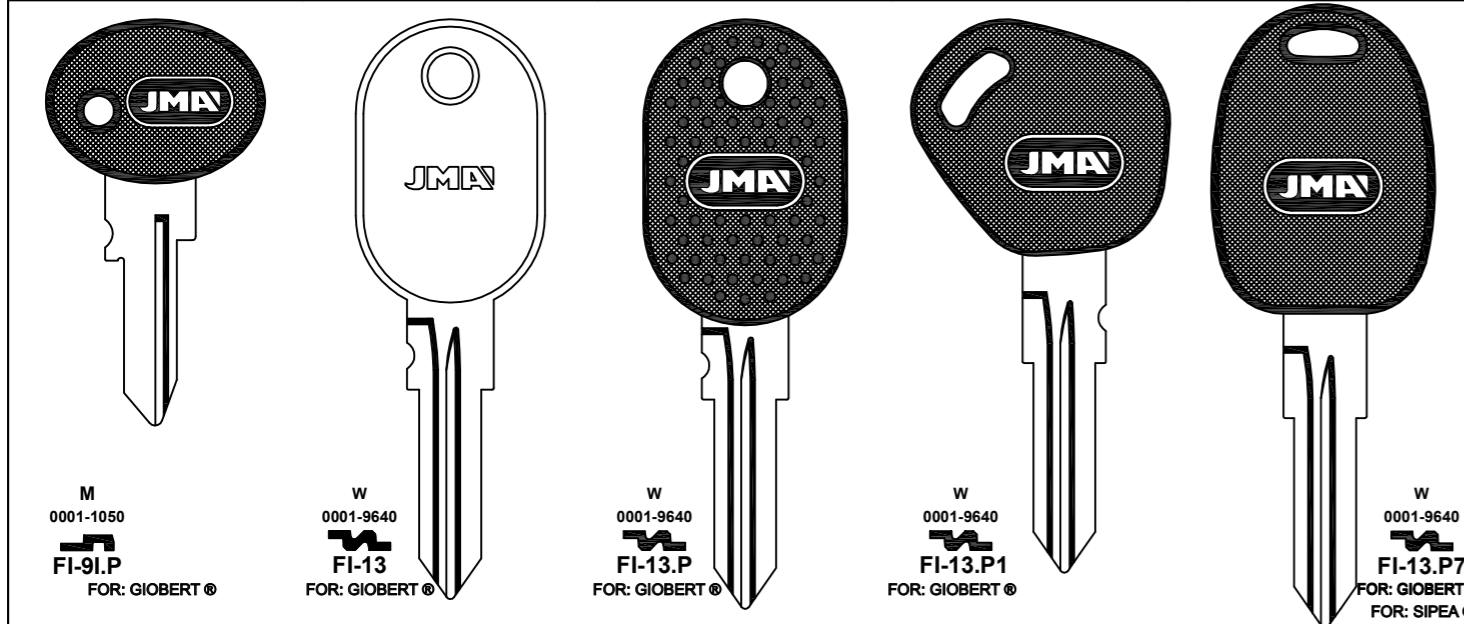

FOR: RENAULT®

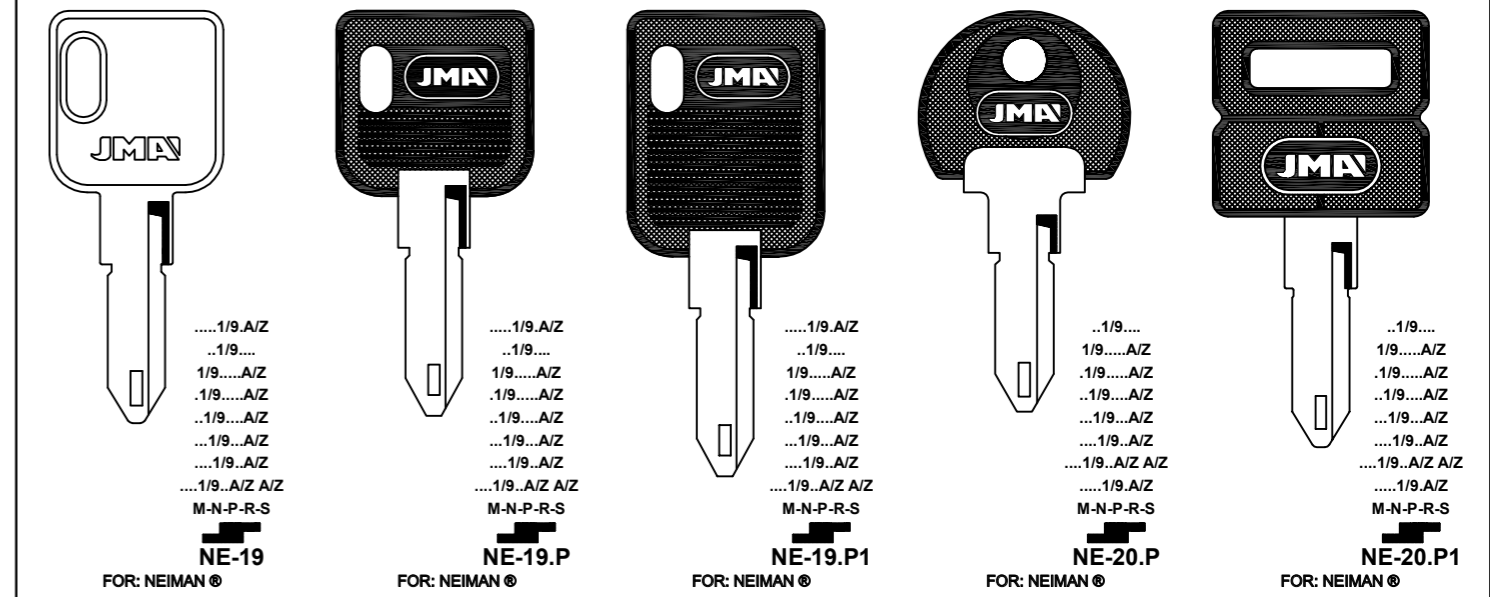

FOR: RENAULT®

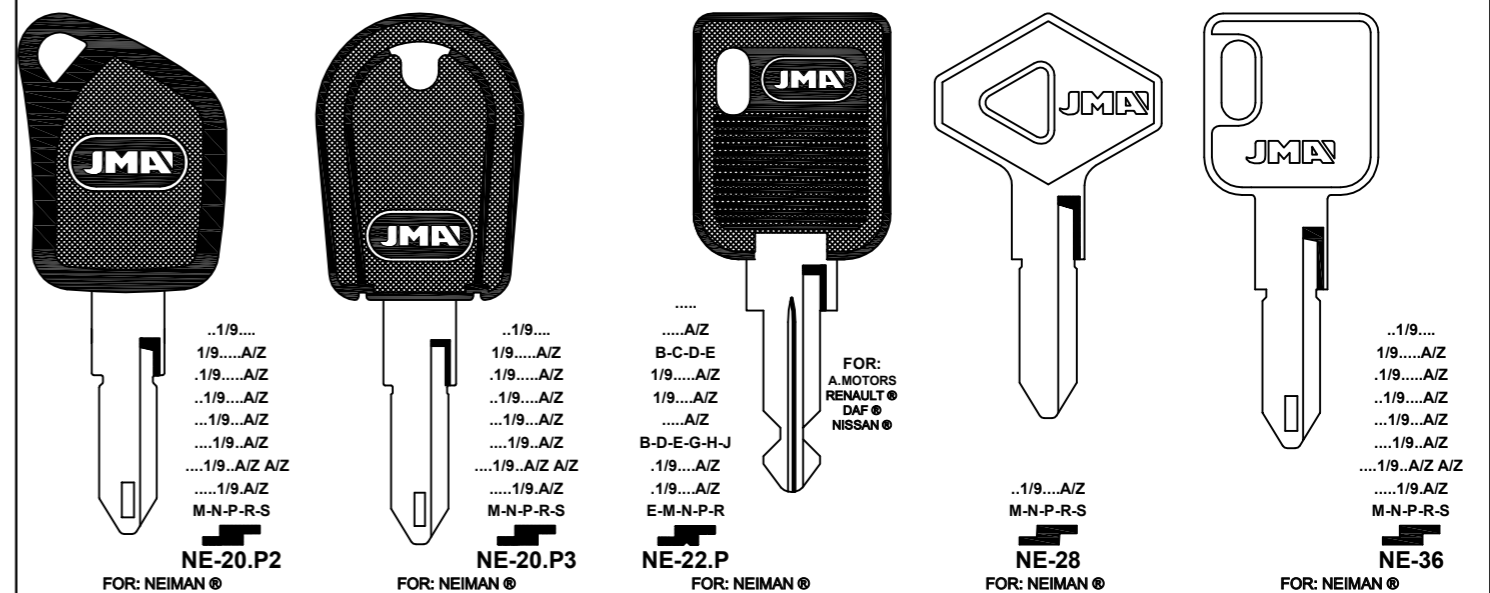

FOR: RENAULT®

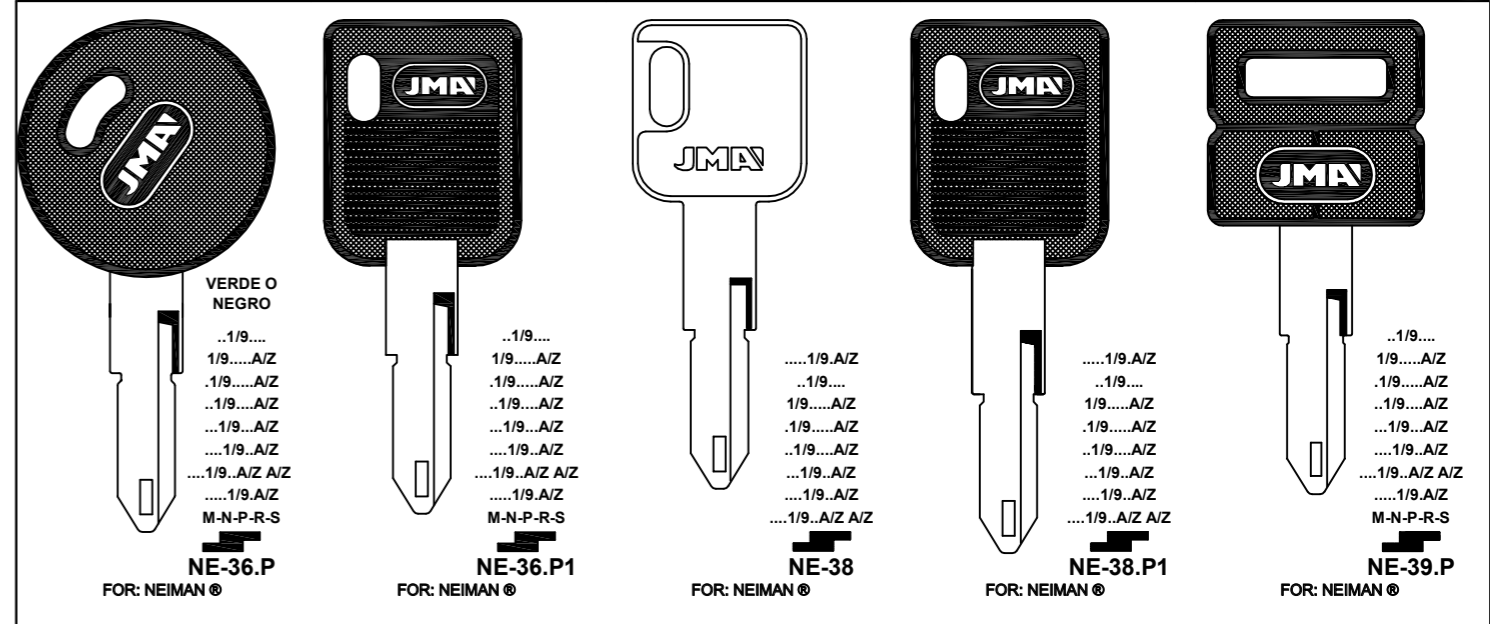

Concerning the marks and commercial denominations see legal warning.
Concerniente a las marcas y denominaciones comerciales ver aviso legal.
Marka eta izendapen komertzialiei dagokienez, ikus lege-oharra.
Concernant les marques et denominations commerciales voir la note dans l'index.

JMA Opening the future

JMA Opening the future

Beziehen auf die marke und handelsname sehen sie die notiz im Impressum.
Relativamente às marcas e denominações comerciais, ver aviso legal.
Jeśli chodzi o znaki i nazwy handlowe, patrz Informacje prawne.

FOR: RENAULT®

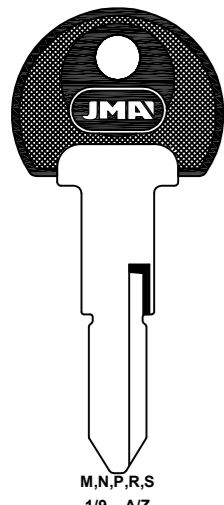

M,N,P,R,S
1/9...A/Z
NE-50.P
FOR: NEIMAN®

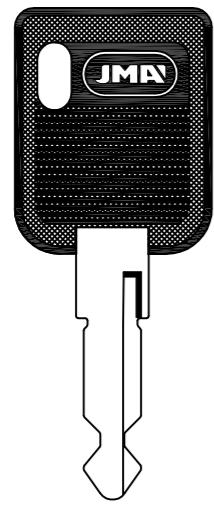

NE-55.P
FOR: NEIMAN (RA)®

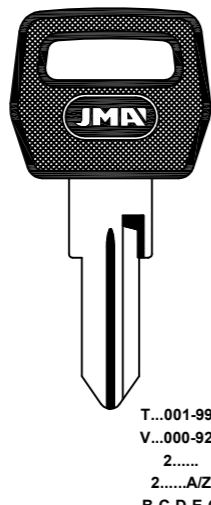

T...001-999
V...000-922
2.....
2.....A/Z
B-C-D-E-G
NE-59.P
FOR: NEIMAN®
FOR: CLAUSOR®

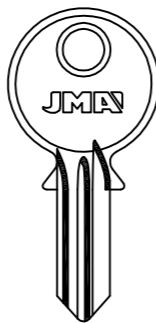

...4AB-ZZ
S...331-348
RO-2I

AA-JZ
A4...A.4.
RO-4I

AB-ZZ
...6
RO-6I

FOR: RONIS®
FOR: ABSA® -FROSER® -PJ® -SADV®

...3AB-ZZ
...1 AL 4
RO-2D

AA-JZ
A3...A.3.
S...213-246
RO-4D

AB-ZZ
...7
S...367-384
RO-6D

FOR: NEIMAN®

FOR: RENAULT (ARGENTINA)®

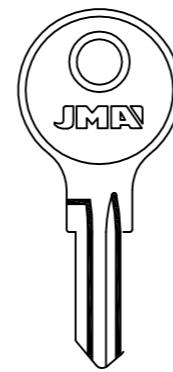

GAS-1
FOR: GAS®

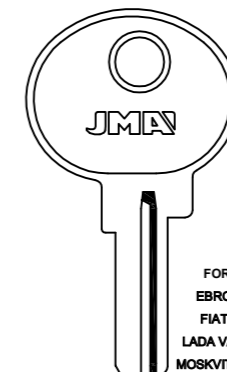

GAS-1D
FOR: GAS®

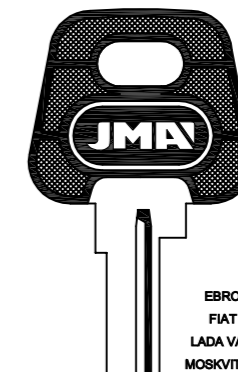

FOR:
EBRO®
FIAT®
LADA VAZ®
MOSKVITCH®
PEUGEOT®
RENAULT®
TALBOT SIMCA®
ZAZ®
DAF®
VOLVO®
.....A/Z
A/Z.....
A/Z.....A/Z
1 AL 7
.....A/Z
0 AL 9
NE-3
FOR: NEIMAN®
FOR: CLAUSOR®

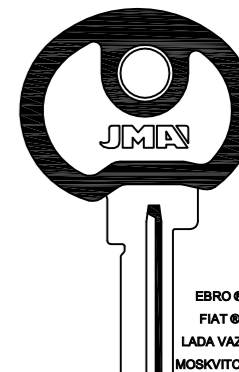

FOR:
EBRO®
FIAT®
LADA VAZ®
MOSKVITCH®
PEUGEOT®
RENAULT®
TALBOT SIMCA®
ZAZ®
DAF®
VOLVO®
.....A/Z
A/Z.....
A/Z.....A/Z
1 AL 7
.....A/Z
0 AL 9
NE-3.P2
FOR: NEIMAN®
FOR: CLAUSOR®

FOR: RENAULT®

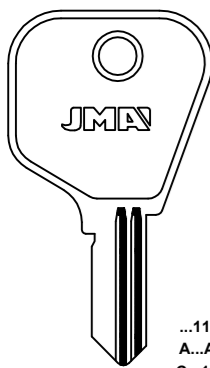

...11 1-700
A...A1-700
C...101-600
D...1-1000
T...1-380
TA...1-224
GV...1-300
F1-500
1F-1-21
RO-11
FOR: RONIS®
FOR: ABSA® -SADV® -SIMPLEX®

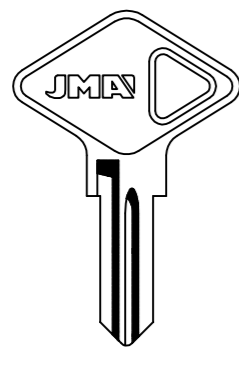

70.....
1 AL 3
...1-975
RO-15
FOR: RONIS®

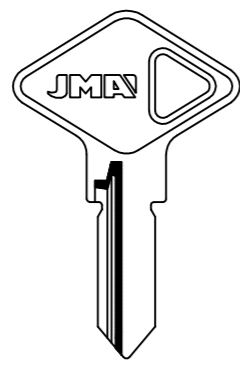

1R...000-999
2R...1000-1837
3R...000-665
VA-7
FOR: VACHETTE®

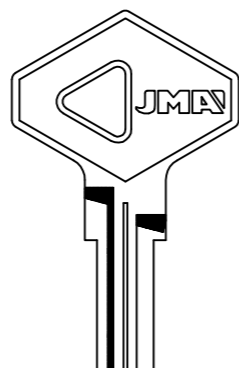

A/Z.....
.....A/Z
.....A/Z 1/9
2700-4816
VA-10
FOR: VACHETTE®

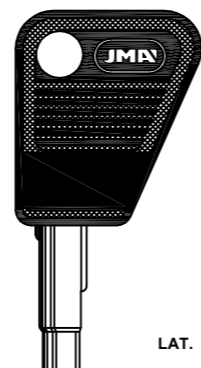

...A/Z
A/Z...A/Z
1000-2560
.E...A/Z 0 AL 4
VA-17.P
FOR: VACHETTE®
FOR: NEIMAN®

FOR: RENAULT (ARGENTINA)®

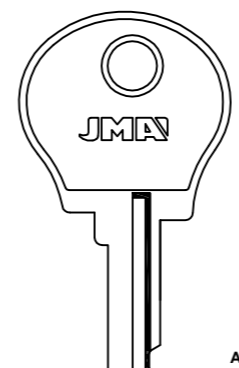

.A/Z.....
.A/Z...A/Z
A/Z.....A/Z
0 AL 8
1 AL 7
A/Z.....1 AL 7 Y A AL E
NE-4
11-34-39....
1 AL 7
34-39...A/Z
1 AL 7
NE-15I
FOR: NEIMAN®
FOR: CLAUSOR®

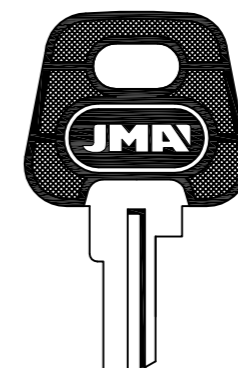

NE-4D
NE-15D

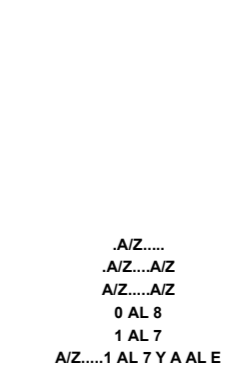

.A/Z.....
.A/Z...A/Z
A/Z.....A/Z
0 AL 8
1 AL 7
A/Z.....1 AL 7 Y A AL E
NE-4.P
11-34-39....
1 AL 7
34-39...A/Z
1 AL 7
NE-15I.P
FOR: NEIMAN®
FOR: CLAUSOR®

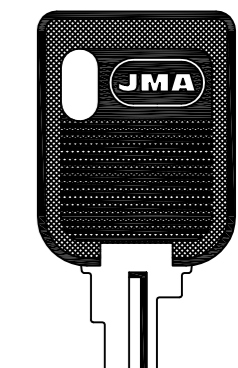

.A/Z.....
.A/Z...A/Z
A/Z.....A/Z
0 AL 8
1 AL 7
A/Z.....1 AL 7 Y A AL E
NE-4.P2
FOR: NEIMAN®
FOR: CLAUSOR®

FOR: RENAULT®

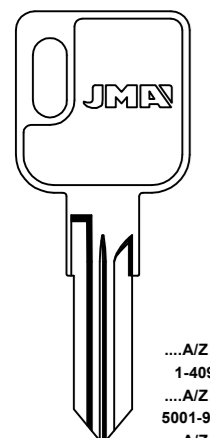

.....A/Z 0/9
1-4092
.....A/Z 0/9
5001-9092
.....A/Z 0/9
1-4092
.....A/Z 0/9
5001-9092
VA-34
FOR: VACHETTE®

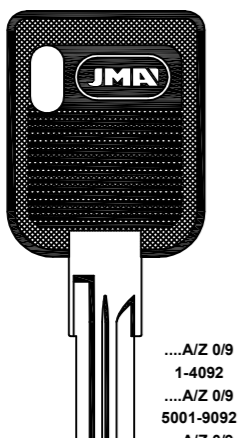

.....A/Z 0/9
1-4092
.....A/Z 0/9
5001-9092
.....A/Z 0/9
1-4092
.....A/Z 0/9
5001-9092
VA-34.P
FOR: VACHETTE®

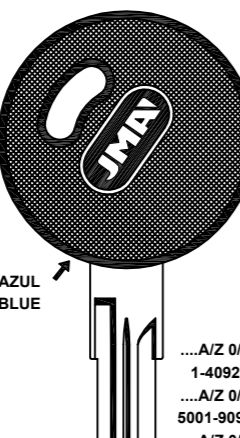

AZUL BLUE

.....A/Z 0/9
1-4092
.....A/Z 0/9
5001-9092
.....A/Z 0/9
1-4092
.....A/Z 0/9
5001-9092
VA-34.P1
FOR: VACHETTE®



.....A/Z 0/9
1-4092
.....A/Z 0/9
5001-9092
.....A/Z 0/9
1-4092
.....A/Z 0/9
5001-9092
VA-34.P2
FOR: VACHETTE®

FOR: RENAULT(ARG.)®

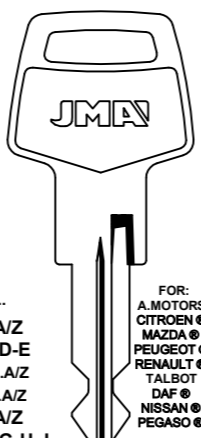

.....
.....A/Z
B-C-D-E
1/9...A/Z
1/9...A/Z
.....A/Z
B-D-E-G-H-J
1/9...A/Z
1/9...A/Z
E-M-N-P-R
CHR-3
FOR: CHRYSLER®
FOR: CLAUSOR® -NEIMAN®

FOR: RENAULT (ARGENTINA)®

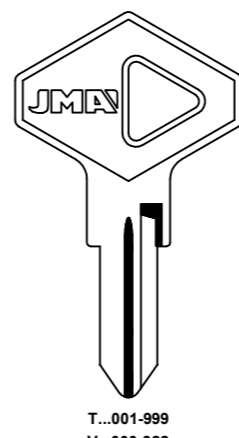

T...001-999
V...000-922
2.....
2.....A/Z
B-C-D-E-G
NE-16
FOR: NEIMAN®
FOR: CLAUSOR®

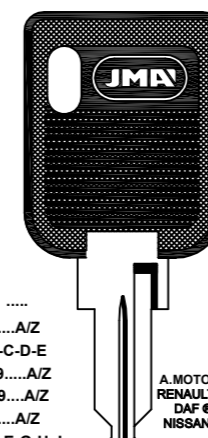

.....
.....A/Z
B-C-D-E
1/9...A/Z
1/9...A/Z
.....A/Z
B-D-E-G-H-J
1/9...A/Z
1/9...A/Z
E-M-N-P-R
NE-22.P
FOR: NEIMAN®
FOR: CLAUSOR®

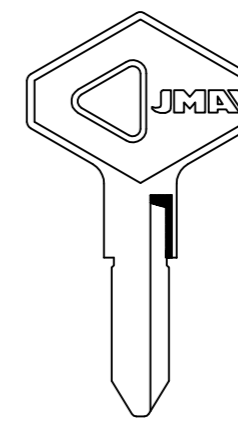

..1/9...A/Z
M-N-P-R-S
NE-28
FOR: NEIMAN®

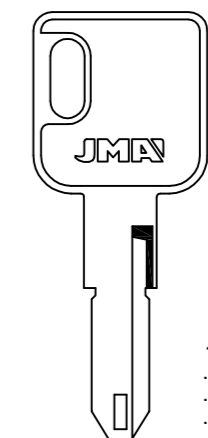

..1/9....
1/9...A/Z
..1/9...A/Z
..1/9...A/Z
.....1/9...A/Z
.....1/9...A/Z
.....1/9...A/Z
M-N-P-R-S
NE-36
FOR: NEIMAN®

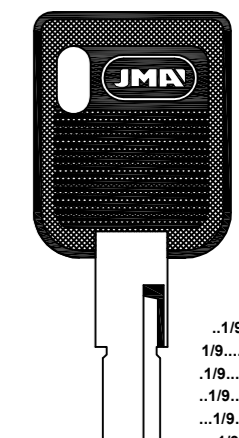

..1/9....
1/9...A/Z
..1/9...A/Z
..1/9...A/Z
.....1/9...A/Z
.....1/9...A/Z
.....1/9...A/Z
M-N-P-R-S
NE-36.P1
FOR: NEIMAN®

Concerning the marks and commercial denominations see legal warning.
Concerniente a las marcas y denominaciones comerciales ver aviso legal.
Marka eta izendapen komertzialiei dagokienez, ikus lege-oharra.
Concernant les marques et denominations commerciales voir la note dans l'index.

JMA Opening the future

JMA Opening the future

Beziehen auf die marke und handelsname sehen sie die notiz im Impressum.
Relativamente às marcas e denominações comerciais, ver aviso legal.
Jeśli chodzi o znaki i nazwy handlowe, patrz Informacje prawne.

FOR: RENAULT (ARGENTINA) ®

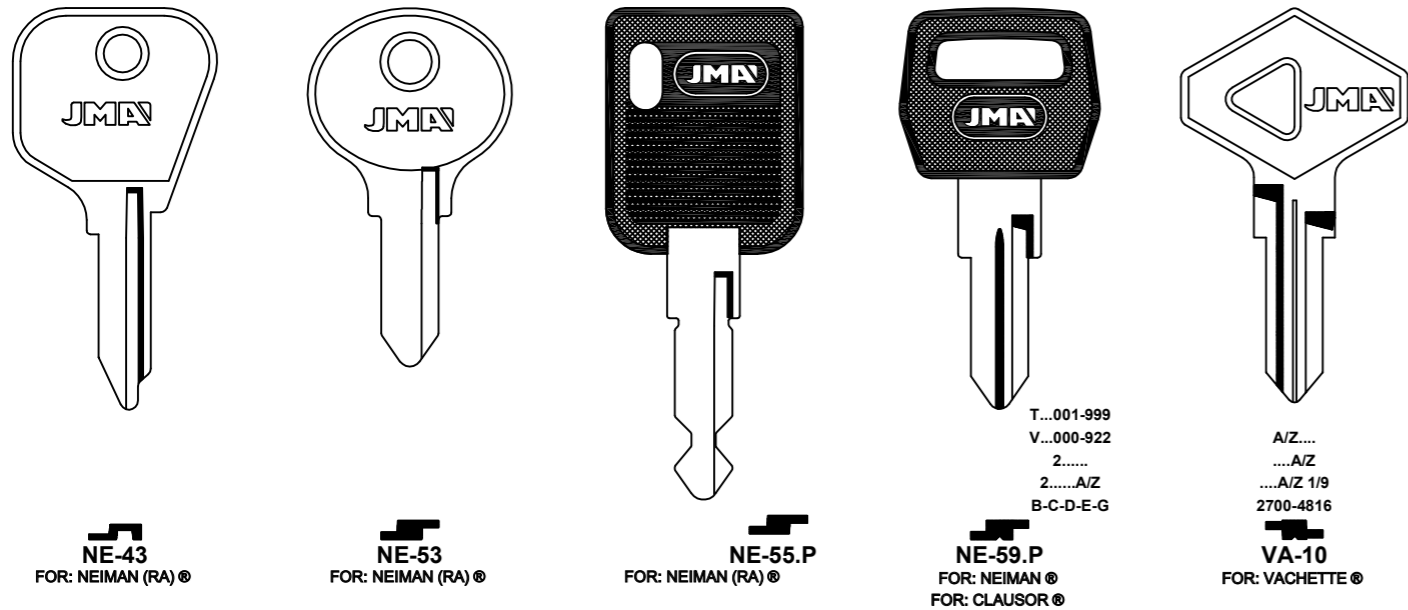

FOR: RENAULT SAVIEM ®

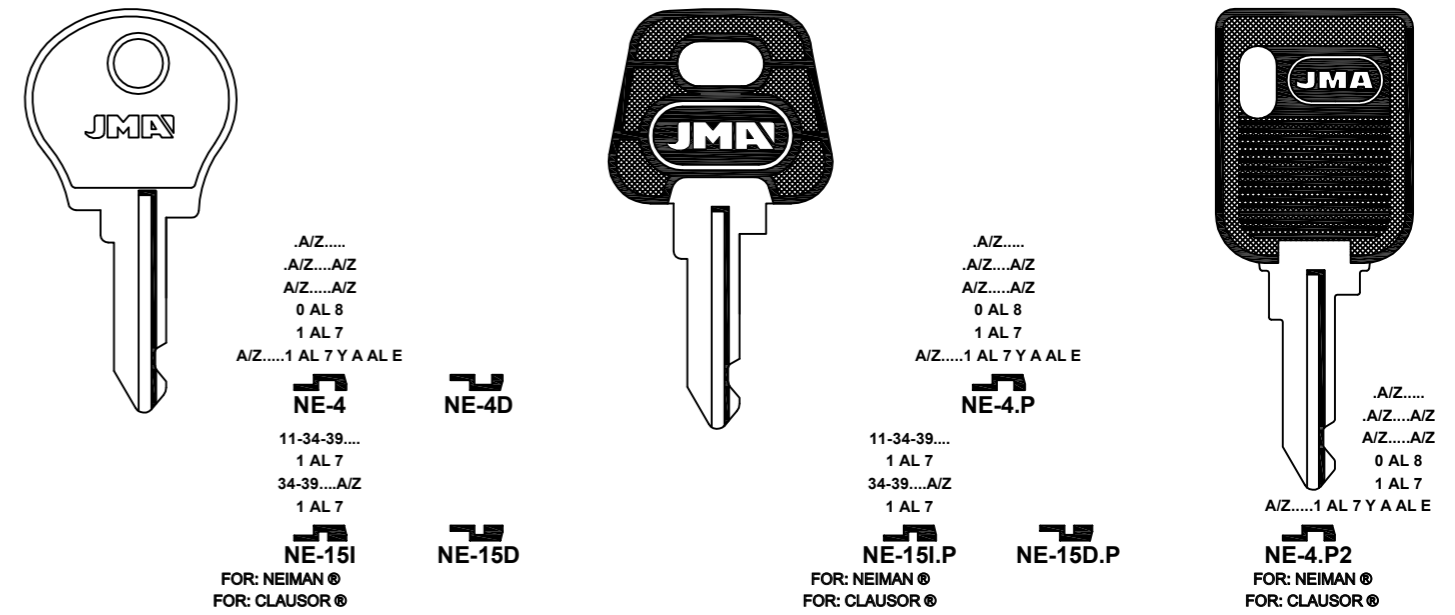

FOR: RENAULT DACIA ®

FOR: RENAULT SAVIEM ®

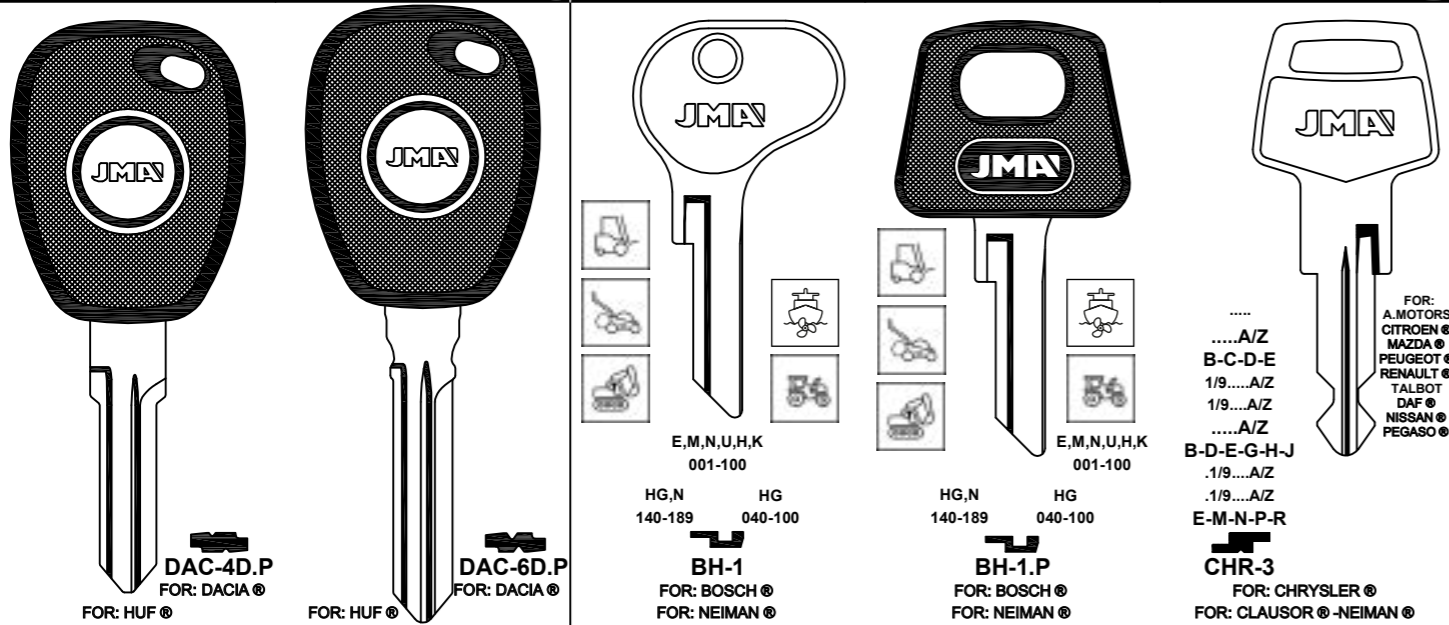

FOR: RENAULT SAVIEM ®

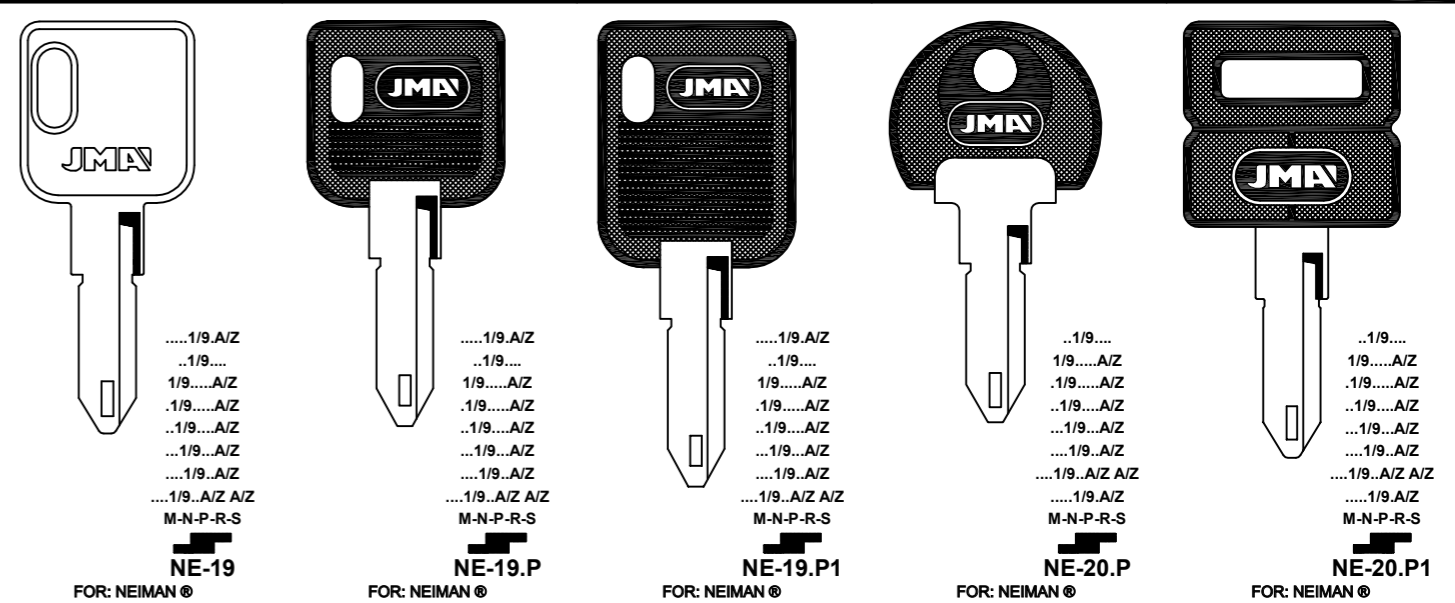

FOR: RENAULT SAVIEM ®

FOR: RENAULT SAVIEM ®

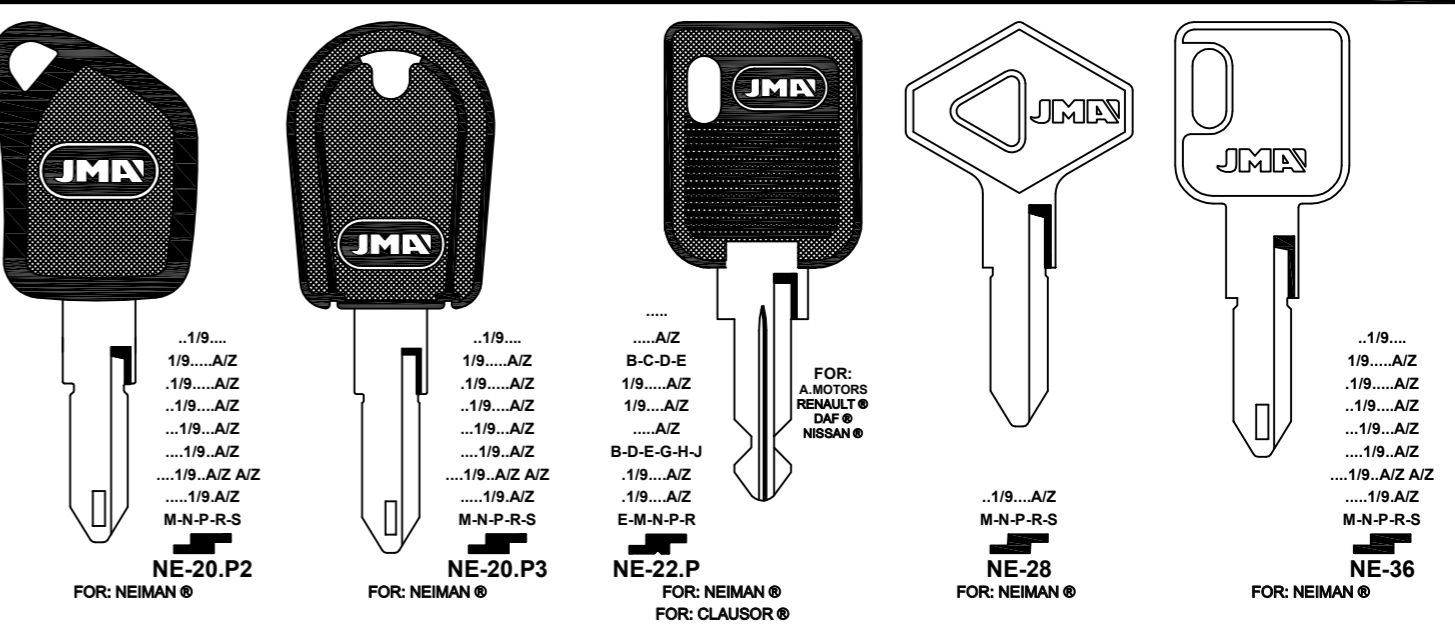
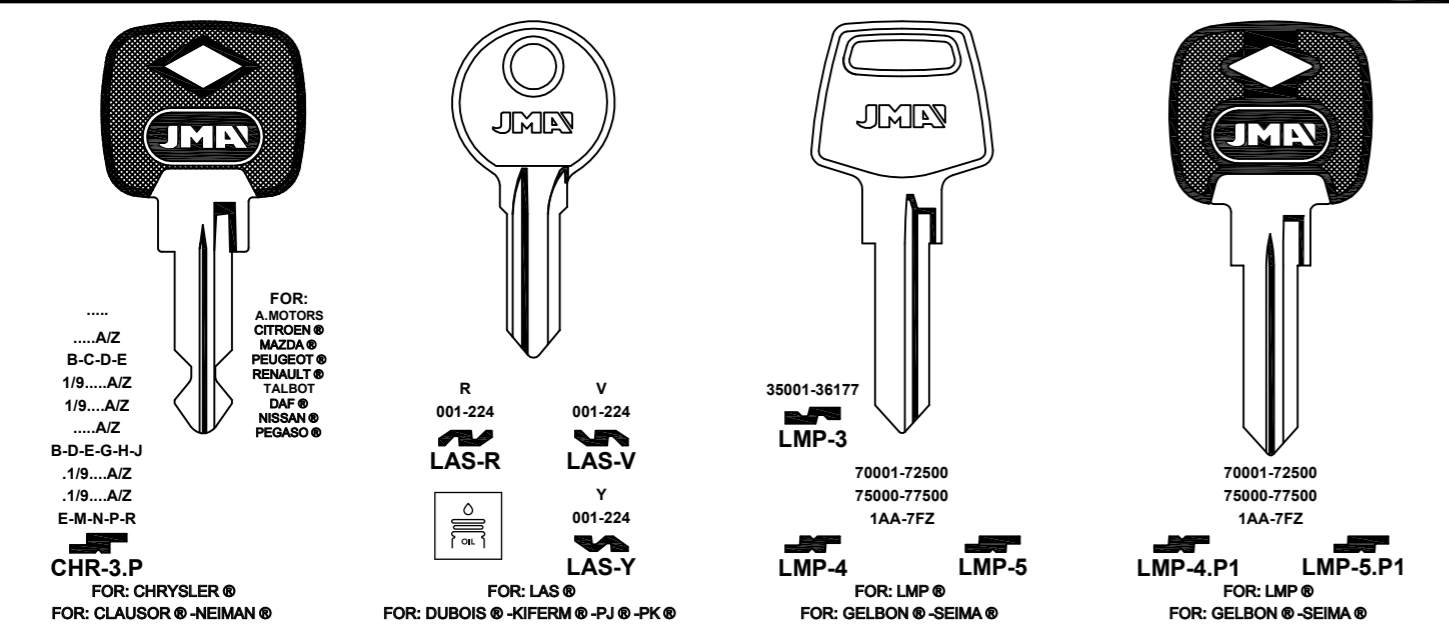

Concerning the marks and commercial denominations see legal warning.
Concerniente a las marcas y denominaciones comerciales ver aviso legal.
Marka eta izendapen komertzialiei dagokienez, ikus lege-oharra.
Concernant les marques et denominations commerciales voir la note dans l'index.

JMA Opening the future

JMA Opening the future

Beziehen auf die marke und handelsname sehen sie die notiz im Impressum.
Relativamente às marcas e denominações comerciais, ver aviso legal.
Jeśli chodzi o znaki i nazwy handlowe, patrz Informacje prawne.

FOR: RENAULT SAVIEM®

VERDE O NEGRO
 ..1/9...
 1/9...A/Z
 ..1/9...A/Z
 ...1/9...A/Z
 ...1/9...A/Z
 ...1/9...A/Z
 ...1/9...A/Z
 ...1/9...A/Z
 M-N-P-R-S
NE-36.P
 FOR: NEIMAN®

..1/9...
 1/9...A/Z
 ..1/9...A/Z
 ...1/9...A/Z
 ...1/9...A/Z
 ...1/9...A/Z
 ...1/9...A/Z
 ...1/9...A/Z
 M-N-P-R-S
NE-36.P1
 FOR: NEIMAN®

..1/9...
 1/9...A/Z
 ..1/9...A/Z
 ...1/9...A/Z
 ...1/9...A/Z
 ...1/9...A/Z
 ...1/9...A/Z
 ...1/9...A/Z
 M-N-P-R-S
NE-39.P
 FOR: NEIMAN®

J...
 001-224
PJ-1
 FOR: PJ®
 FOR: KIFERM®

J...
 001-224
PJ-2
 FOR: PJ®
 FOR: KIFERM®

FOR: RENAULT SAVIEM®

..4AB-ZZ
 S...331-348
RO-2I

..3AB-ZZ
1 AL 4
RO-2D

AA-JZ
 A4.../A.4.
RO-4I

AA-JZ
 A3.../A.3.
 S...213-246
RO-4D

AB-ZZ
 ..6
 S...349-366
RO-6I

AB-ZZ
 ..7
 S...367-384
RO-6D

70.....
 1 AL 3
 ...1-975
RO-15
 FOR: RONIS®

77....
 0 AL 3
RO-17
 FOR: RONIS®

J...
 001-224
PJ-2.P
 FOR: PJ®
 FOR: KIFERM®

A8..AA-DS
 ..8AB-ZZ
 S...385-402
RO-1I

A9..AA-DS
 ..8AB-ZZ
 S...403-420
RO-1D

FOR: ABSA® -FROSER® -PJ® -SADV®

FOR: RONIS®

FOR: RENAULT SAVIEM®

1R...000-999
 2R...1000-1837
 3R...000-665
VA-7
 FOR: VACHETTE®

A/Z....
A/Z
 ...A/Z 1/9
 2700-4816
VA-10
 FOR: VACHETTE®

FOR: ROLLS ROYCE®

RRL
YA-18D
 FOR: YALE®

RRM
YA-19D
 FOR: YALE®

NRRL
YA-20I
 FOR: YALE®

NRRL
YA-20D
 FOR: YALE®

FOR: ROLLS ROYCE®

NRRM
YA-21I
 FOR: YALE®

JA...
YA-21D
 FOR: YALE®

FOR: ROVER®

AK
 0001-1000
 TC
 0001-1000
 TX
 0001-1859
FO-E/TC.P
 FOR: FORD®

AK
 0001-1000
 TC
 0001-1000
 TX
 0001-1859
FO-E/TC.P
 FOR: FORD®

3001-4481
HOND-10
 3001-4481
HOND-11
 FOR: HONDA®

FOR: ROVER®

FOR: ASTON MARTIN®
 JAGUAR®
 LAND ROVER®
 MG®
 ROVER®
 VOLVO®

FP
 626-750
IN-1

FK
 01-99
 876-955
IN-5

3001-4481
HOND-10.P

3001-4481
HOND-11.P
 FOR: HONDA®

FOR: UNION®

FS
 01-99
 876-955
IN-4

FR
 751-875
UN-4

15001-19000
 85001-87000
LF-9
 FOR: L. & F.®
 FOR: BRITAX®

BL....
 BL...N
 1001-2000
LF-BL
 FOR: L. & F.®
 FOR: BRITAX®

FOR:
 AUSTIN®
 CARBODIES®
 INNOCENTI®
 LAND ROVER®
 LOTUS®
 MASERATI®
 OM IVECO®
 ROVER®
 VAUXHALL®
 BEDFORD®
 FIAT IVECO®

RO
 BL...N
 1001-2000
LF-RO
 FOR: L. & F.®

FOR: ROVER®

FOR:
 AUSTIN®
 CARBODIES®
 INNOCENTI®
 LAND ROVER®
 LOTUS®
 MASERATI®
 OM IVECO®
 ROVER®
 VAUXHALL®
 BEDFORD®
 FIAT IVECO®

RO
 BL...N
 1001-2000
LF-RO.P

...2001-4949
 GM
 ...2001-3000
NE-1

FOR: L. & F.®

FOR:
 AUDI®
 HONDA®
 MG®
 ROVER®
 BEDFORD®
 FIAT IVECO®
 VOLVO®

...2001-4949
 GM®
 ...2001-3000
NE-1D

FOR: NEIMAN®
 FOR: CLAUSOR®

FOR:
 AUDI®
 HONDA®
 MG®
 ROVER®
 BEDFORD®
 FIAT IVECO®
 VOLVO®

NSP....
 4000-4999
 7001-9000
 E....
 2001-3000
 4001-5000
 S....
 2001-3000
NE-11

FOR: NEIMAN®

NSP....
 4000-4999
 7001-9000
 E....
 2001-3000
 4001-5000
 S....
 2001-3000
NE-11.P
 FOR: NEIMAN®

Concerning the marks and commercial denominations see legal warning.
 Concerniente a las marcas y denominaciones comerciales ver aviso legal.
 Marka eta izendapen komertzialiei dagokienez, ikus lege-oharra.
 Concernant les marques et dénominations commerciales voir la note dans l'index.

FOR: SKODA®

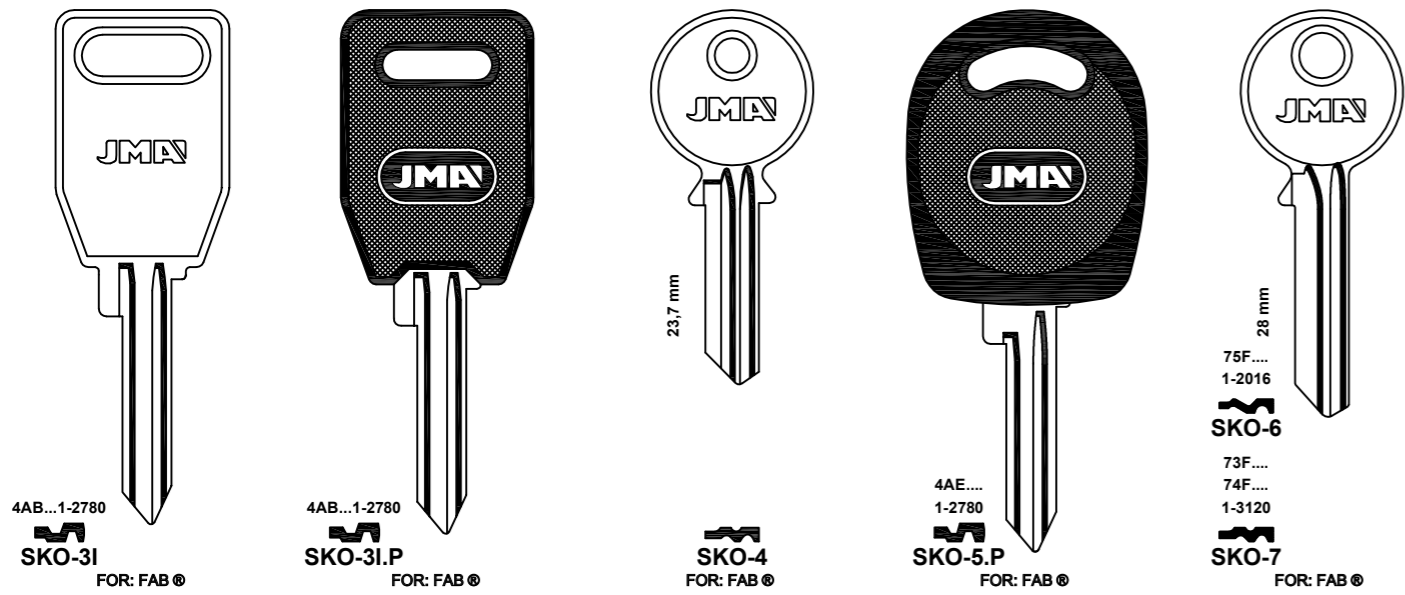

FOR: STEYR-PUCH®

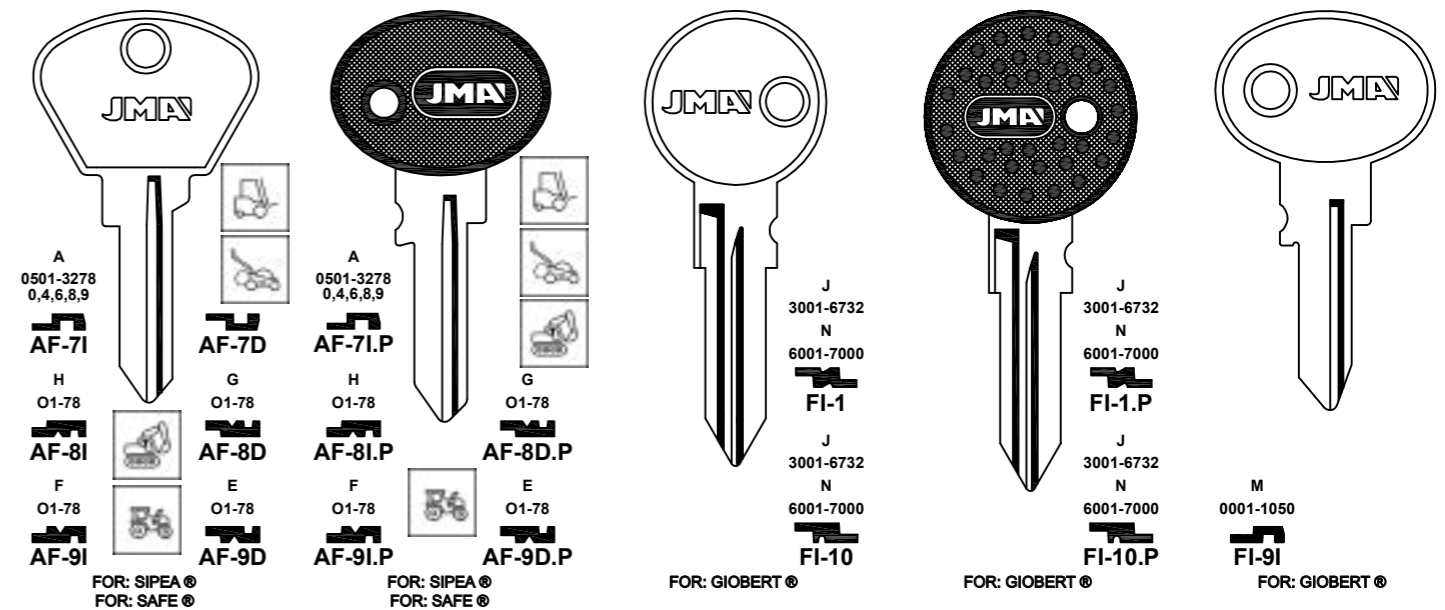

FOR: SKODA®

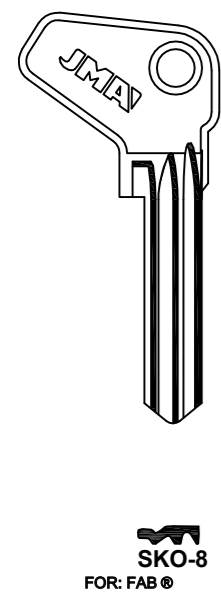

FOR: SSANGYONG®

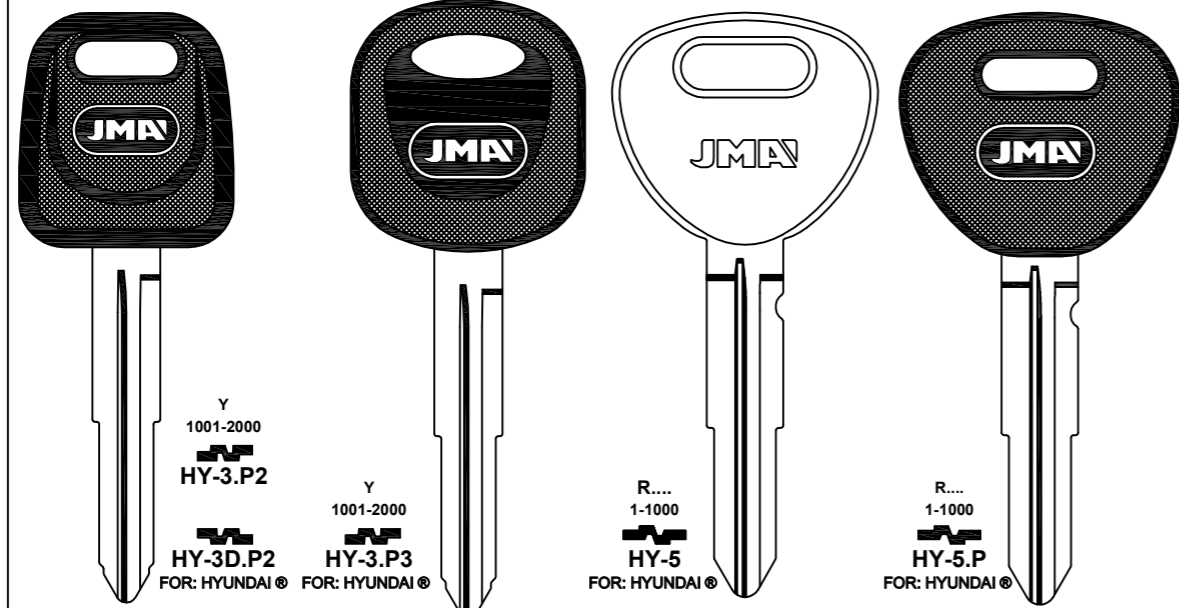

FOR: STEYR-PUCH®

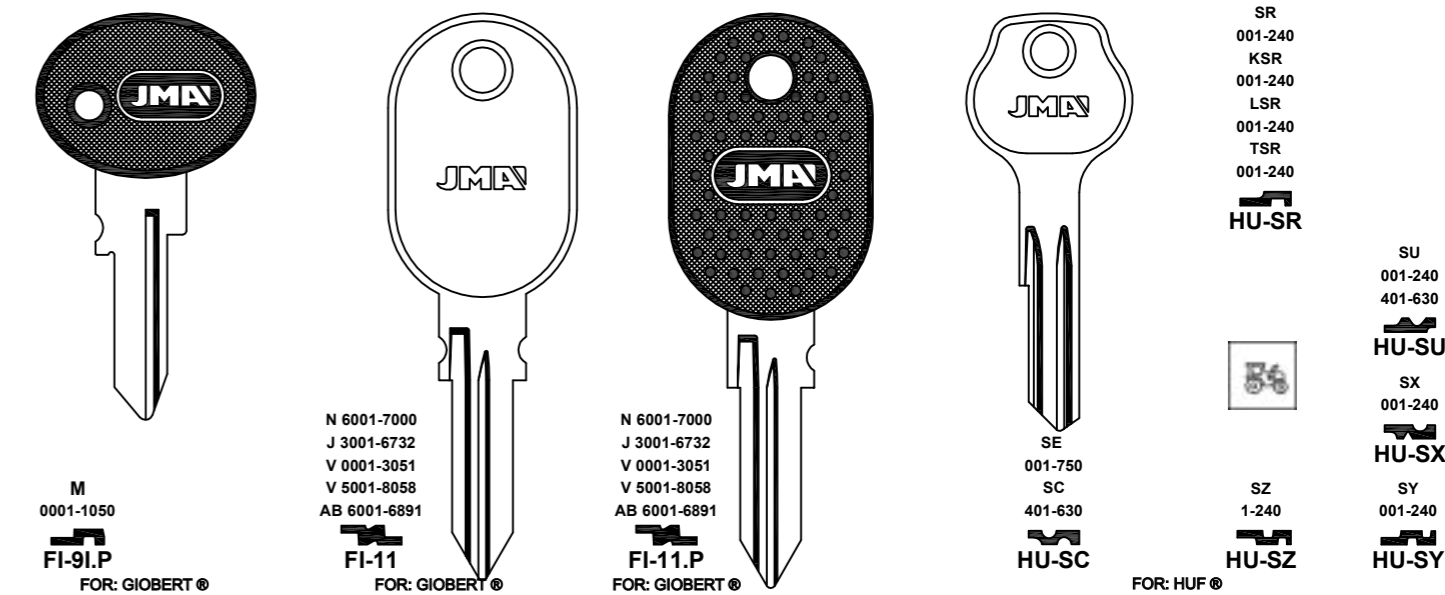

FOR: SSANGYONG®

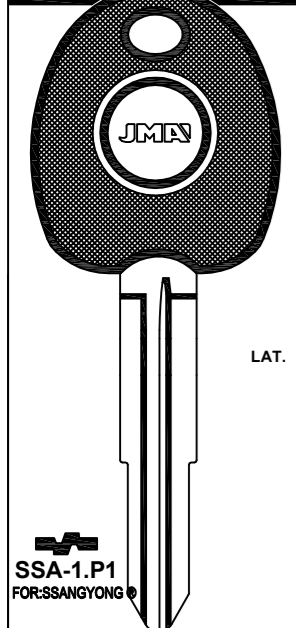

FOR: STERLING®

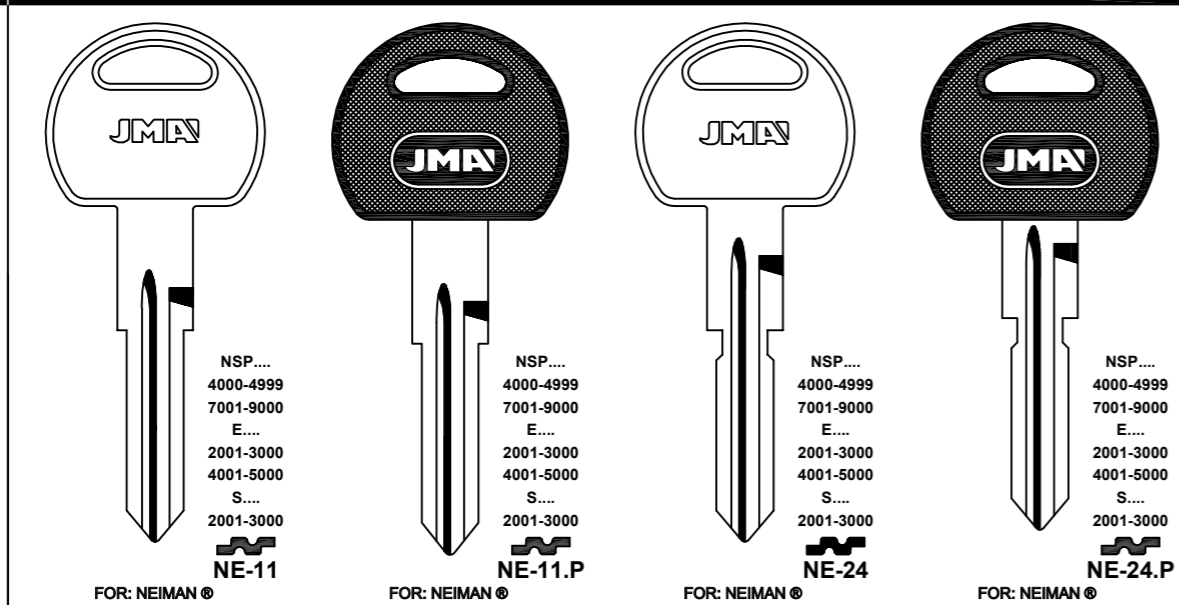

FOR: STEYR-PUCH®

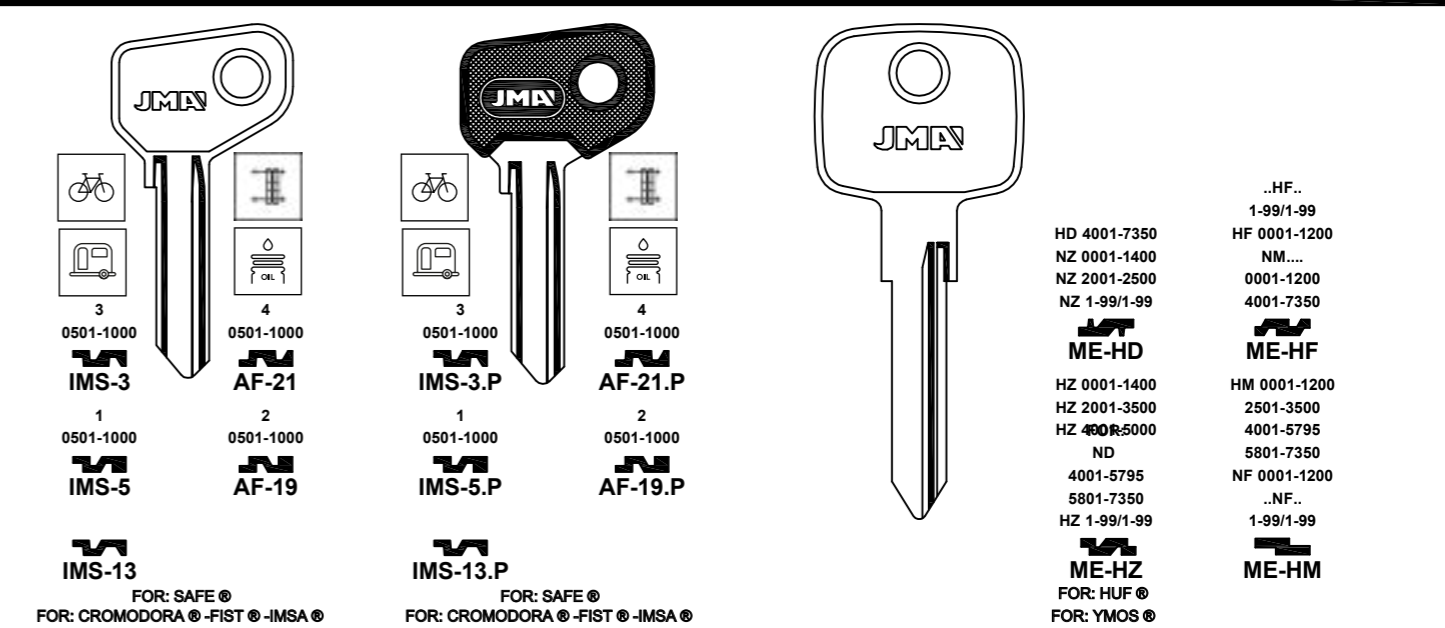

Concerning the marks and commercial denominations see legal warning.
 Concniente a las marcas y denominaciones comerciales ver aviso legal.
 Marka eta izendapen komertzialiei dagokienez, ikus lege-oharra.
 Concernant les marques et denominations commerciales voir la note dans l'index.

JMA Opening the future

JMA Opening the future

Beziehen auf die marke und handelsname sehen sie die notiz im Impressum.
 Relativamente às marcas e denominações comerciais, ver aviso legal.
 Jeśli chodzi o znaki i nazwy handlowe, patrz Informacje prawne.

FOR: STEYR-PUCH®

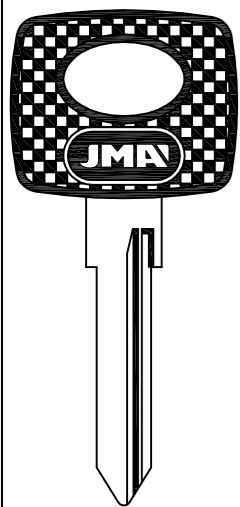

..HF..
1-99/1-99
HD 4001-7350
NZ 0001-1400
NZ 2001-2500
NZ 1-99/1-99

ME-HD.P

HZ 0001-1400
HZ 2001-3500
HZ 4001-5000
ND
4001-5795
5801-7350
HZ 1-99/1-99

ME-HZ.P
FOR: HUF®
FOR: YMOS®

..HF..
1-99/1-99
HF 0001-1200
NM....
0001-1200
4001-7350

ME-HF.P

HM 0001-1200
2501-3500
4001-5795
5801-7350
NF 0001-1200
..NF..
1-99/1-99

ME-HM.P

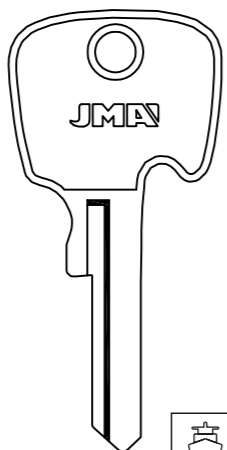

N....1 AL 5
NE-58D
FOR: NEIMAN®
FOR: BOMORO® -BOSCH®

FOR: SUBARU®

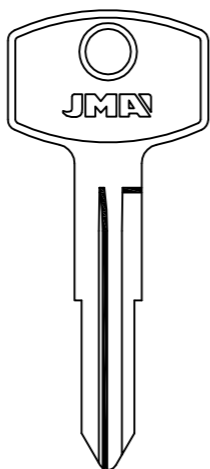

F
0001-1000
1001-2000

M
4001-5000

DAT-11

M
6001-7000
W
0001-1000

DAT-21

M
0001-1000
5001-6000

N
1001-2000

DAT-1D

M
1001-2000

DAT-1D

M
7001-8000

DAT-2D

FOR: NISSAN®
FOR: DATSUN® -WASO®

FOR: SUBARU®

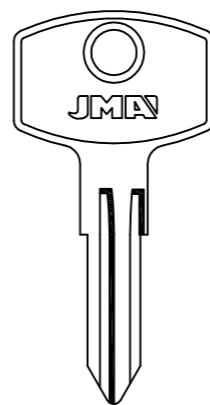

F
0001-1000
1001-2000

M
4001-5000

DAT-8I

M
6001-7000
7001-800

W
0001-1000

DAT-9I

FOR: NISSAN®
FOR: DATSUN®

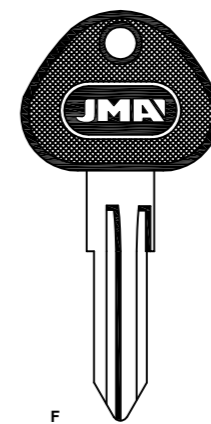

F
0001-1000
1001-2000

M
4001-5000

DAT-8I.P1

FOR: NISSAN®
FOR: DATSUN®



F
0001-1000
1001-2000

M
4001-5000

DAT-8I.P

M
6001-7000
7001-800

W
0001-1000

DAT-9I.P

FOR: NISSAN®
FOR: DATSUN®

M
0001-1000
5001-6000

N
1001-2000

DAT-8.P

M
1001-2000

DAT-8.P

M
7001-800

DAT-9D.P

FOR: NISSAN®
FOR: DATSUN®

FOR: SUBARU®

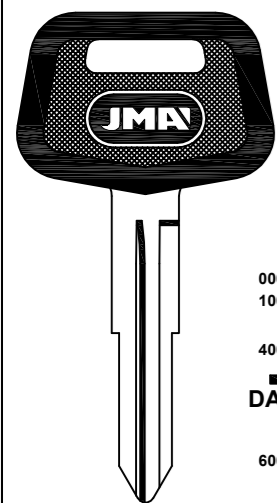

F
0001-1000
1001-2000

M
4001-5000

DAT-11.P

M
6001-7000
W
0001-1000

DAT-21.P

FOR: NISSAN®
FOR: DATSUN® -WASO®

M
0001-1000
5001-6000

N
1001-2000

DAT-1D.P

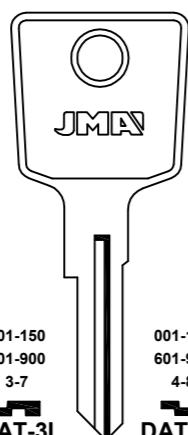

001-150
601-900
3-7

DAT-3I

001-150
601-900
1-5

DAT-4I

FOR: NISSAN®
FOR: DATSUN®

001-150
601-900
4-8

DAT-3D

001-150
601-900
6-9

DAT-4D

FOR: NISSAN®
FOR: DATSUN®

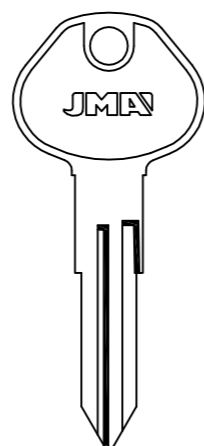

X
0001-8000

DAT-6

DAT-6D

Y
0001-8000
8001-9000

DAT-7

FOR: NISSAN®
FOR: DATSUN®

FOR: SUBARU®

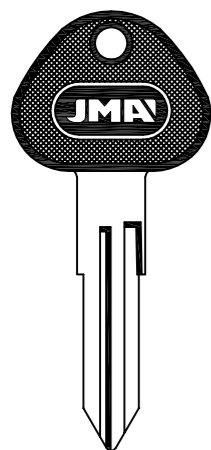

X
0001-8000

DAT-6.P

DAT-6D.P

Y
0001-8000
8001-9000

DAT-7.P

FOR: NISSAN®
FOR: DATSUN®

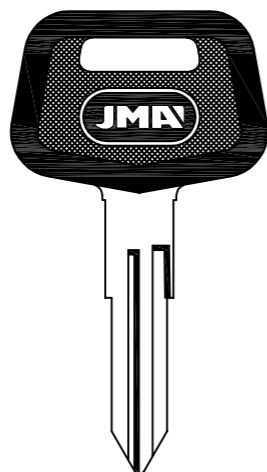

X
0001-8000

DAT-6.P1

DAT-6D.P1

Y
0001-8000
8001-9000

DAT-7.P1

FOR: NISSAN®
FOR: DATSUN®

FOR: SUBARU®

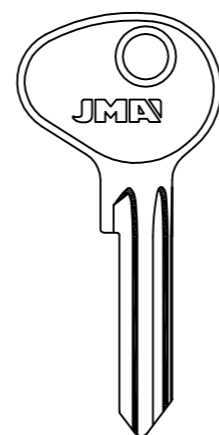

VH
0001-3948

K
00001-14000

DAT-11

FOR: NISSAN®
FOR: DATSUN® -WASO®

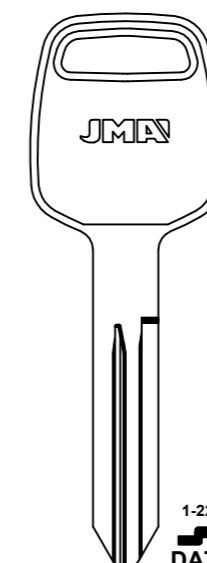

1-22185

DAT-15

FOR: NISSAN®

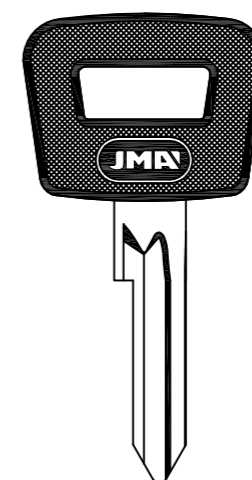

FR...4001-6000
FZ...1-1232

WAS-2.P

FOR: WASO®
FOR: ARMAN® -DOM®

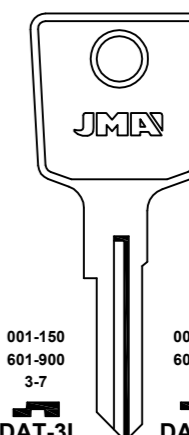

001-150
601-900
3-7

DAT-3I

001-150
601-900
1-5

DAT-4I

FOR: NISSAN®
FOR: DATSUN®

001-150
601-900
4-8

DAT-3D

001-150
601-900
6-9

DAT-4D

FOR: NISSAN®
FOR: DATSUN®

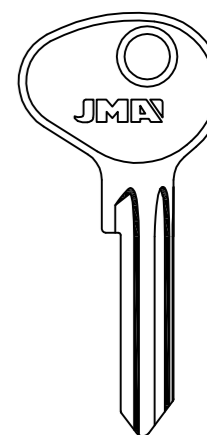

VH
0001-3948

K
00001-14000

DAT-11

DAT-11D

FOR: NISSAN®
FOR: DATSUN® -WASO®

FOR: SUBARU®

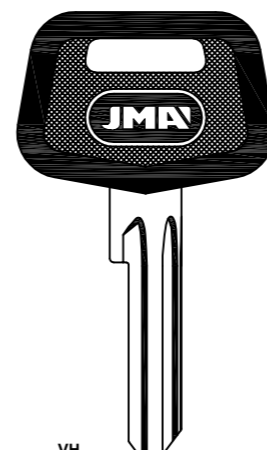

VH
0001-3948

K
00001-14000

DAT-11.P

FOR: NISSAN®
FOR: DATSUN® -WASO®

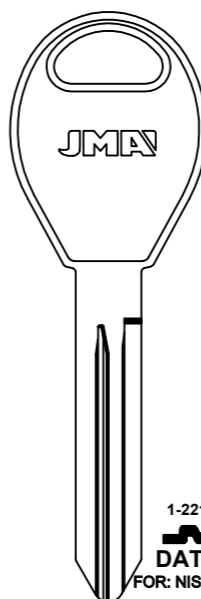

1-22185

DAT-16

T...1-3000

SUB-2.P

FOR: NISSAN®
FOR: SUBARU®

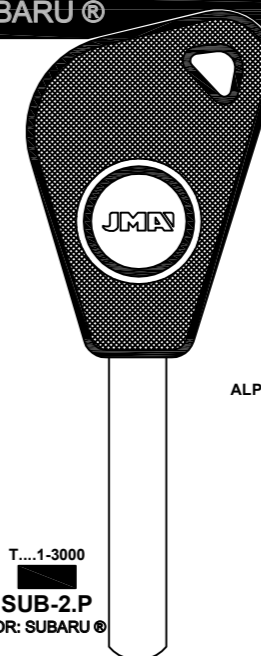

ALP.

LAT.

7.8

TOYO-30.P1

FOR: TOYOTA®

FOR: SULKY®

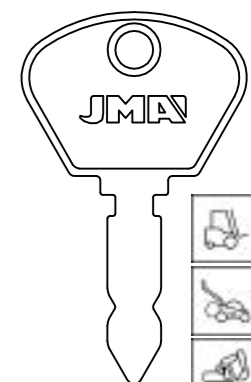

7.1

1.95

BH-4

FOR: BOSCH®
FOR: KOLB® -POLAR®

Concerning the marks and commercial denominations see legal warning.
Concerniente a las marcas y denominaciones comerciales ver aviso legal.
Marka eta izendapen komertzialiei dagokienez, ikus lege-oharra.
Concernant les marques et denominations commerciales voir la note dans l'index.

JMA Opening the future

JMA Opening the future

Beziehen auf die marke und handelsname sehen sie die notiz im Impressum.
Relativamente às marcas e denominações comerciais, ver aviso legal.
Jeśli chodzi o znaki i nazwy handlowe, patrz Informacje prawne.

FOR: SULKY®

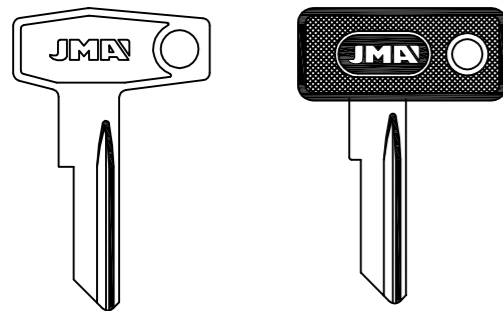

....1-1625
....5001-6278
E...1-710

ZA-1
FOR: ZADI®
FOR: BRETER®



....1-1625
....5001-6278
E...1-710

ZA-1.P
FOR: ZADI®
FOR: BRETER®

FOR: SUNBEAM®

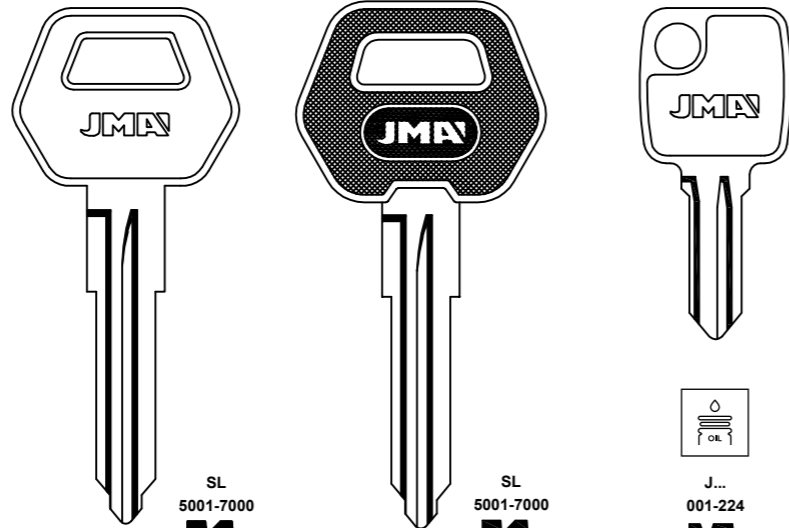

J...
001-224

PJ-2
FOR: PJ®
FOR: KIFERM®

SL
5001-7000

LF-SL
FOR: L. & F.®
FOR: ROOTES®

SL
5001-7000

LF-SL.P
FOR: L. & F.®
FOR: ROOTES®

FOR: SUZUKI®

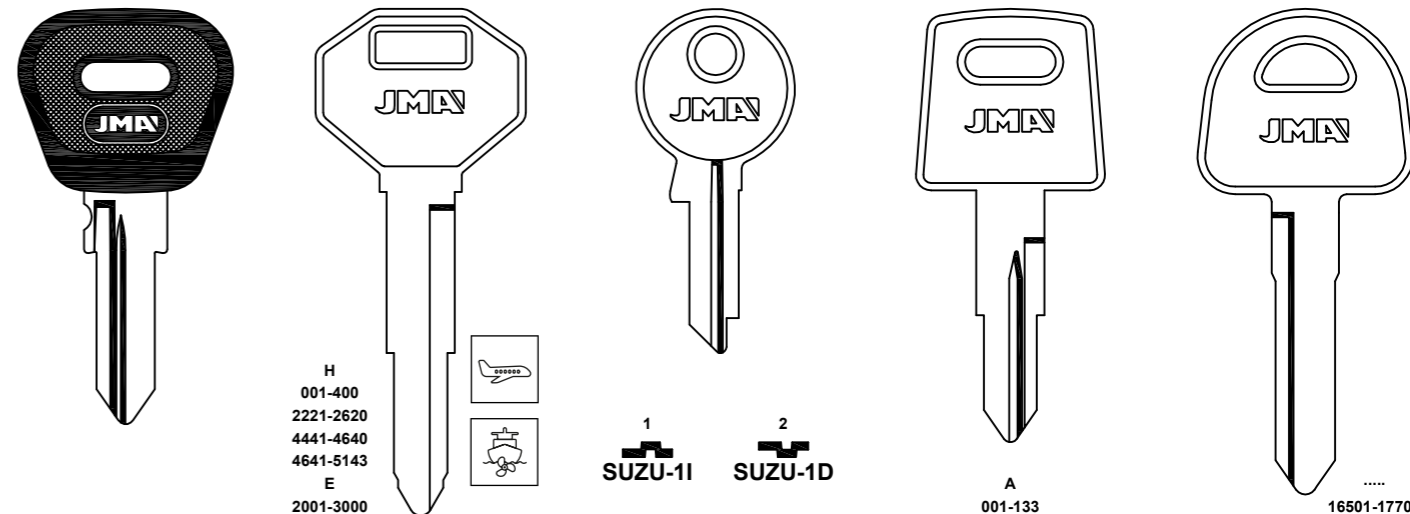

H
001-400
2221-2620
4441-4640
4641-5143
E
2001-3000

MIT-2I
FOR: MITSUBISHI®



MIT-2D
FOR: MITSUBISHI®

1
SUZU-1I

SUZU-2I
FOR: SUZUKI®

2
SUZU-1D

SUZU-2D
FOR: SUZUKI®

A
001-133

SUZU-6
FOR: SUZUKI®

....
16501-17704

SUZU-7
FOR: SUZUKI®

FOR: SUNBEAM®

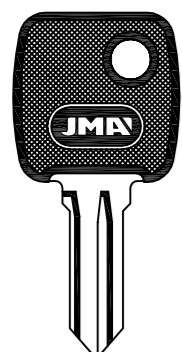

J...
001-224

PJ-2.P
FOR: PJ®
FOR: KIFERM®

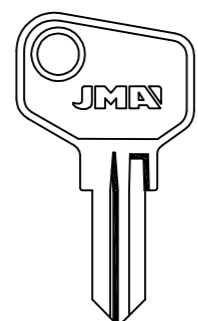

15
AB-6I

14
AB-8I

FOR: ARFE® -FROSER® -KEYA®

13
AB-8D

FOR: ABSA®

FOR: SUZUKI®

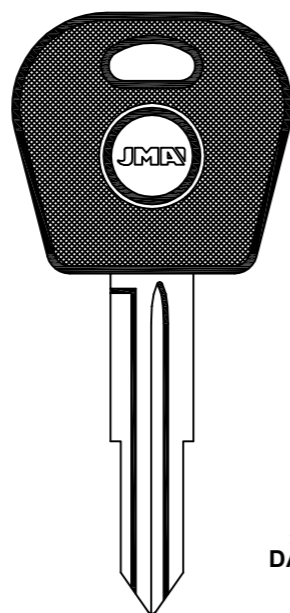

J...
1-1200

DAE-3D.P1

V...
1-1200

DAE-4.P1

T...
1-1200

DAE-4D.P1

FOR: DAEWOO®

FOR: SUZUKI®

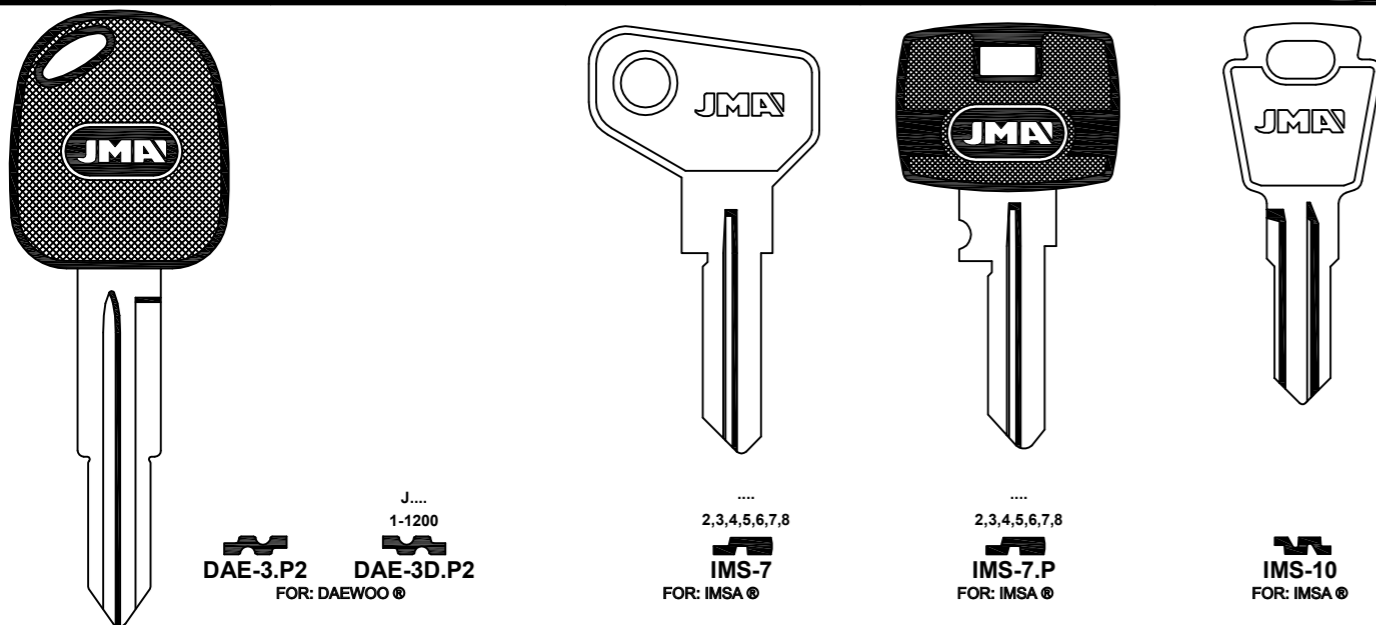

J...
1-1200
DAE-3.P2 **DAE-3D.P2**
FOR: DAEWOO®

....
2,3,4,5,6,7,8
IMS-7
FOR: IMSA®

....
2,3,4,5,6,7,8
IMS-7.P
FOR: IMSA®

....
IMS-10
FOR: IMSA®

FOR: SUZUKI®

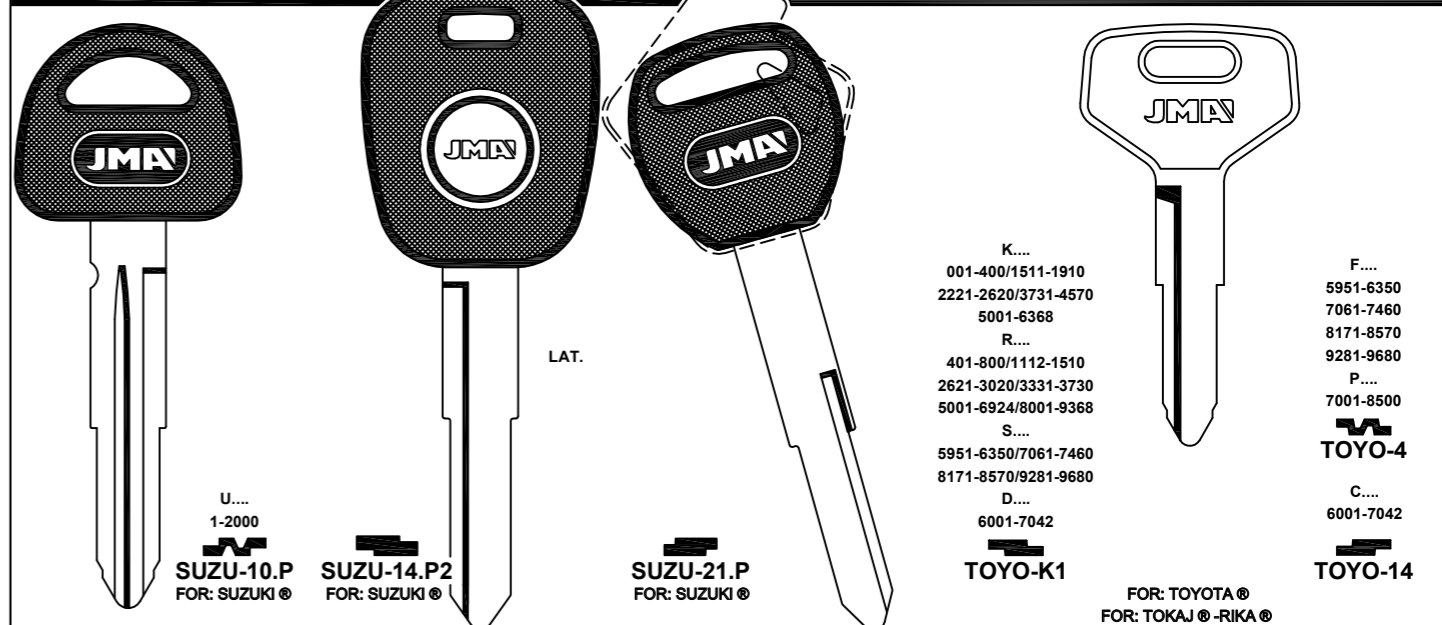

U...
1-2000
SUZU-10.P
FOR: SUZUKI®

SUZU-14.P2
FOR: SUZUKI®

LAT.

SUZU-21.P
FOR: SUZUKI®

K...
001-400/1511-1910
2221-2620/3731-4570
5001-6368
R...
401-800/1112-1510
2621-3020/3331-3730
5001-6924/8001-9368
S...
5951-6350/7061-7460
8171-8570/9281-9680
D...
6001-7042
TOYO-K1

FOR: TOYOTA®
FOR: TOKAJ® -RIKA®

F...
5951-6350
7061-7460
8171-8570
9281-9680
P...
7001-8500
TOYO-4
C...
6001-7042
TOYO-14

Concerning the marks and commercial denominations see legal warning.
Concerniente a las marcas y denominaciones comerciales ver aviso legal.
Marka eta izendapen komertzialiei dagokienez, ikus lege-oharra.
Concernant les marques et denominations commerciales voir la note dans l'index.

JMA Opening the future

JMA Opening the future

Beziehen auf die marke und handelsname sehen sie die notiz im Impressum.
Relativamente às marcas e denominações comerciais, ver aviso legal.
Jeśli chodzi o znaki i nazwy handlowe, patrz Informacje prawne.



FOR: SUZUKI®

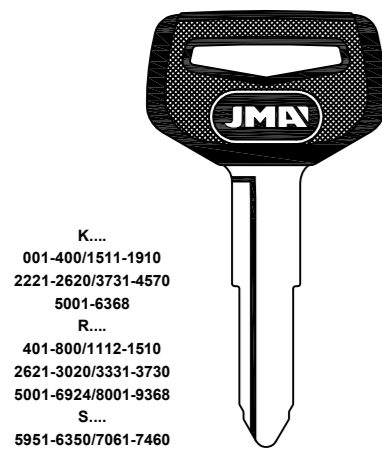

K....
001-400/1511-1910
2221-2620/3731-4570
5001-6368
R....
401-800/1112-1510
2621-3020/3331-3730
5001-6924/8001-9368
S....
5951-6350/7061-7460
8171-8570/9281-9680

F....
5951-6350
7061-7460
8171-8570
9281-9680
P....
7001-8500

TOYO-4.P

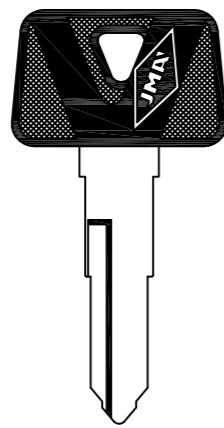

1 AL 4
32010-79897

A....
32010-79897
YAMA-18I.P

B....
32010-79897
YAMA-18D.P

C....
32010-79897
YAMA-19I.P

D....
32010-79897
YAMA-19D.P

E....
32010-79897
YAMA-20I.P

F....
32010-79897
YAMA-20D.P

C....
32010-79897
YAMA-28.P

E....
32010-79897
YAMA-29.P

FOR: YAMAHA®

TOYO-K1.P

FOR: TOYOTA®
FOR: TOKAJ®-RIKA®

TOYO-14.P

FOR: TOYOTA®

FOR: TALBOT SIMCA®

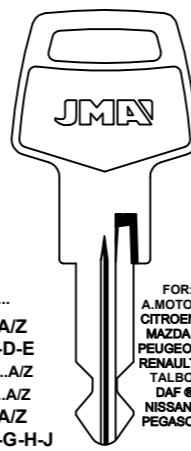

FOR: A.MOTORS
CITROEN®
MAZDA®
PEUGEOT®
RENAULT®
TALBOT®
DAF®
NISSAN®
PEGASO®

.....
A/Z
B-C-D-E
1/9...A/Z
1/9...A/Z
1/9...A/Z
B-D-E-G-H-J
.1/9...A/Z
.1/9...A/Z
E-M-N-P-R
CHR-3
FOR: CHRYSLER®
FOR: CLAUSOR®-NEIMAN®

FOR: TALBOT SIMCA®

CHR-4I CHR-4D
RO-1IS RO-1DS
BT 001-650 LAS-BT LAS-TB
TB 001-650 LAS-CR LAS-RC
35001-36177 LMP-3 70001-72500 75000-77500 1AA-7FZ
35001-36177 LMP-3.P 70001-72500 75000-77500 1AA-7FZ
LMP-4 LMP-5 LMP-4.P LMP-5.P
FOR: LMP® FOR: LMP®
FOR: GELBON®-SEIMA® FOR: GELBON®-SEIMA®

.....A/Z
A/Z.....
A/Z.....A/Z
1 AL 7
.....A/Z
0 AL 9
NE-3 NE-3D
FOR: NEIMAN®
FOR: CLAUSOR®

FOR: EBRO®
FIAT®
LADA VAZ®
MOSKVITCH®
PEUGEOT®
RENAULT®
TALBOT SIMCA®
ZAZ®
DAF®
VOLVO®

FOR: TALBOT SIMCA®

.....A/Z
A/Z.....
A/Z.....A/Z
1 AL 7
.....A/Z
0 AL 9
NE-3.P1
FOR: NEIMAN®
FOR: CLAUSOR®

EBRO®
FIAT®
LADA VAZ®
MOSKVITCH®
PEUGEOT®
RENAULT®
TALBOT SIMCA®
ZAZ®
DAF®
VOLVO®

.....A/Z
A/Z.....
A/Z.....A/Z
1 AL 7
.....A/Z
0 AL 9
NE-3.P2
FOR: NEIMAN®
FOR: CLAUSOR®

.....A/Z
B-C-D-E
1/9...A/Z
1/9...A/Z
.....A/Z
B-D-E-G-H-J
.1/9...A/Z
.1/9...A/Z
E-M-N-P-R
NE-22.P2
FOR: NEIMAN®
FOR: CLAUSOR®

.....A/Z
B-C-D-E
1/9...A/Z
1/9...A/Z
.....A/Z
B-D-E-G-H-J
.1/9...A/Z
.1/9...A/Z
E-M-N-P-R
NE-44.P
FOR: NEIMAN®
FOR: CLAUSOR®

.....A/Z
B-C-D-E
1/9...A/Z
1/9...A/Z
.....A/Z
B-D-E-G-H-J
.1/9...A/Z
.1/9...A/Z
E-M-N-P-R
NE-33.P1
FOR: NEIMAN®
FOR: CLAUSOR®

FOR: TALBOT SIMCA®

J...
001-224
PJ-1
FOR: PJ®
FOR: KIFERM®

J...
001-224
PJ-2
FOR: PJ®
FOR: KIFERM®

J...
001-224
PJ-2.P
FOR: PJ®
FOR: KIFERM®

K....4-6-8
K....4-6-8-A-B-C
G..01-99
PJ-3
FOR: PJ®

K....4-6-8
K....4-6-8-A-B-C
PJ-K
FOR: PJ®

FOR: TALBOT SIMCA®

..4AB-ZZ
S...331-348
RO-2I

..3AB-ZZ
....1 AL 4
RO-2D

AA-JZ
A4...A.4.
RO-4I

AA-JZ
A3...A.3.
S...213-246
RO-4D

AB-ZZ
..6
S...349-366
RO-6I

AB-ZZ
..7
S...367-384
RO-6D

K....4-6-8
K....4-6-8-A-B-C
PJ-K.P
FOR: PJ®

A8..AA-DS
..8AB-ZZ
S...385-402
RO-1I

A9..AA-DS
..8AB-ZZ
S...403-420
RO-1D

FOR: RONIS®
FOR: ABSA®-FROSER®-PJ®-SADV®

E...
001-649
VA-6
FOR: VACHETTE®
FOR: SIMPLEX®

E...
001-649
VA-6.P
FOR: VACHETTE®
FOR: SIMPLEX®

FOR: TALBOT SIMCA®

1R...000-999
2R...1000-1837
3R...000-665
VA-7
FOR: VACHETTE®

A...000-999
B...000-999
F...000-116
VA-16
FOR: VACHETTE®

FOR: TATA®

FOR: TATA® TAT-1D

FOR: TATA® TAT-1D.P

FOR: TATA® TAT-2D.P

Concerning the marks and commercial denominations see legal warning.
Concieniente a las marcas y denominaciones comerciales ver aviso legal.
Marka eta izendapen komertzialiei dagokienez, ikus lege-oharra.
Concernant les marques et denominations commerciales voir la note dans l'index.

FOR: TOYOTA®

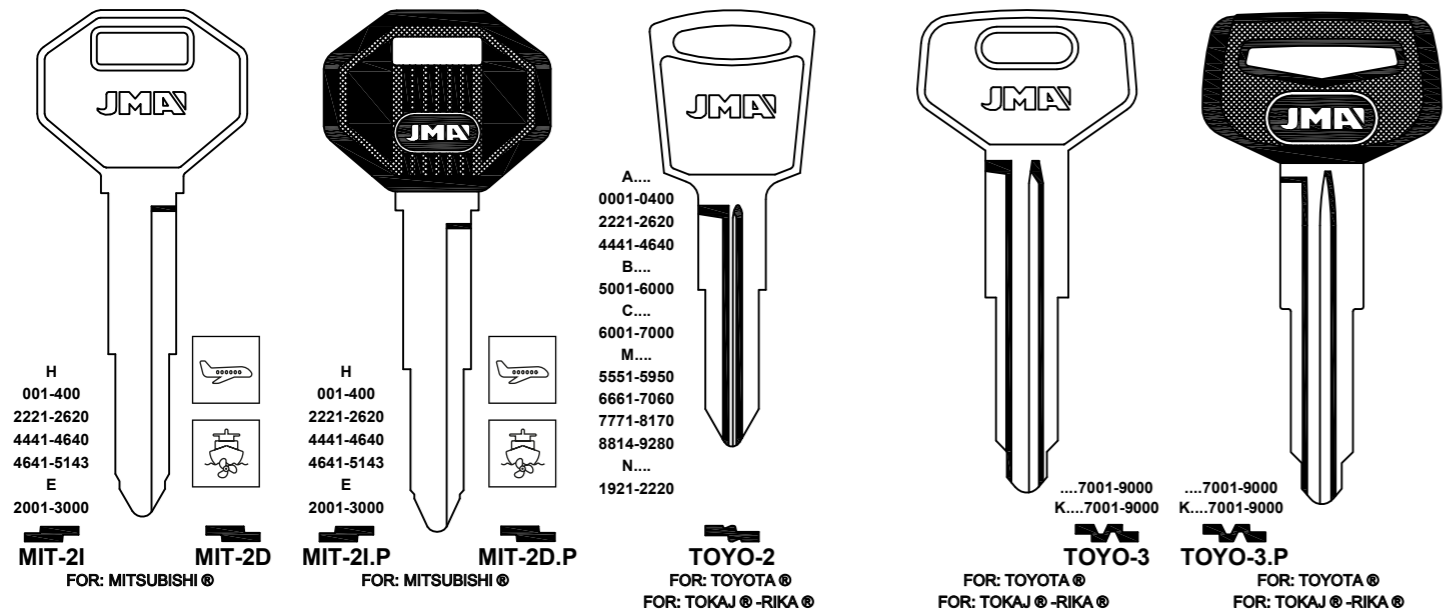

FOR: TOYOTA®

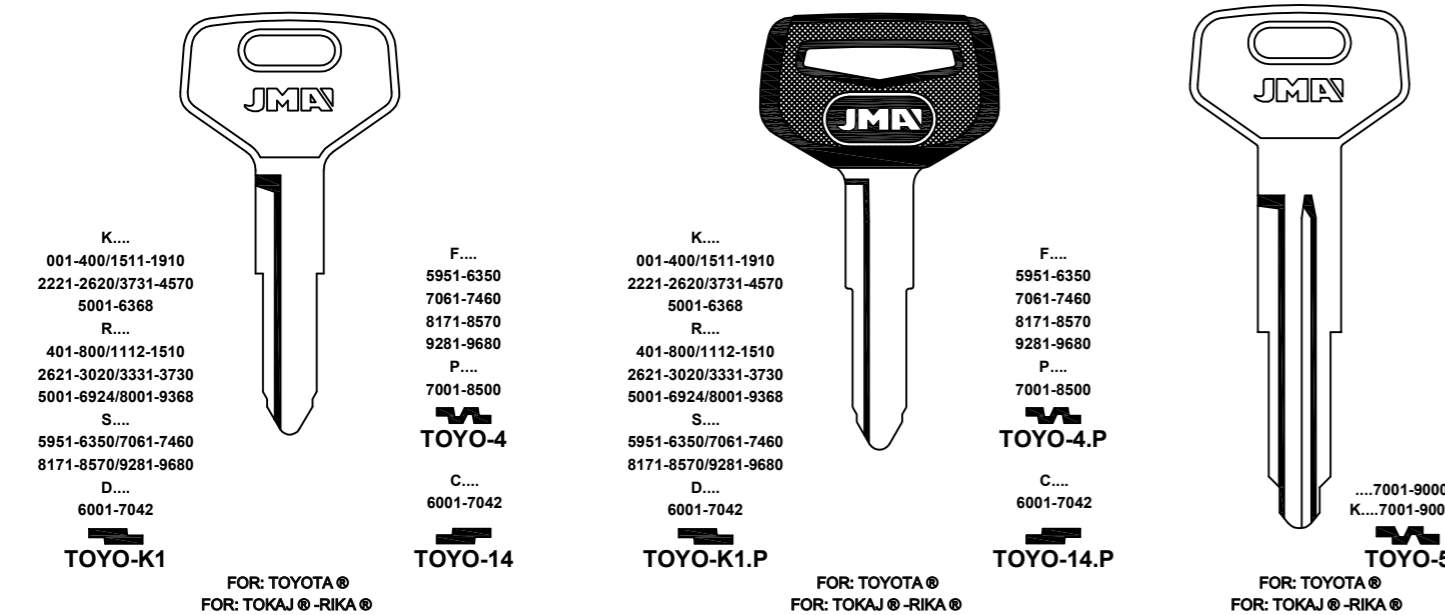

FOR: TOYOTA®

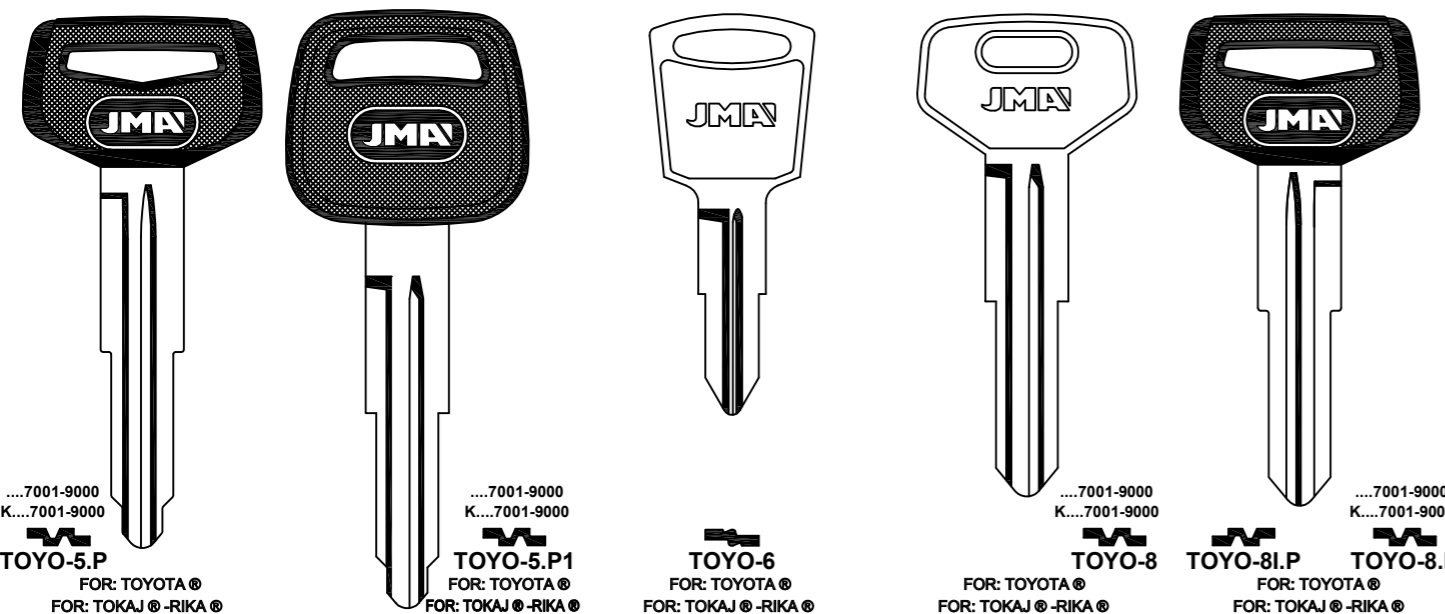

FOR: TOYOTA®

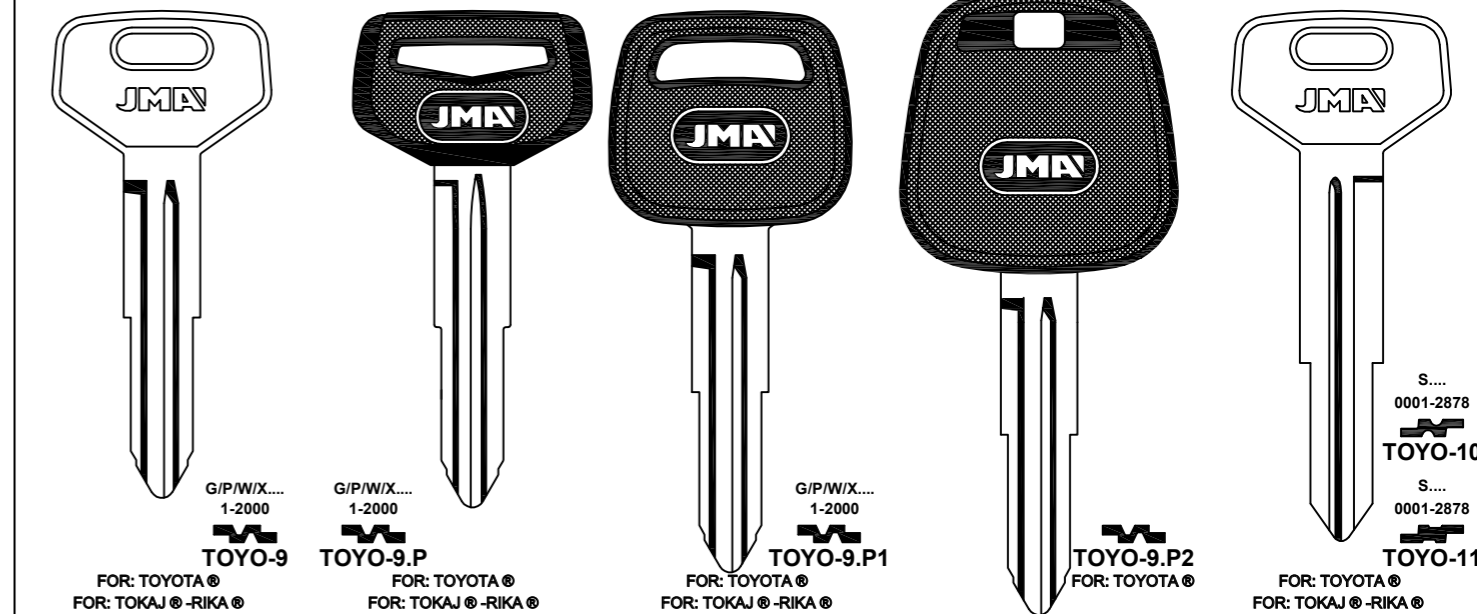

FOR: TOYOTA®

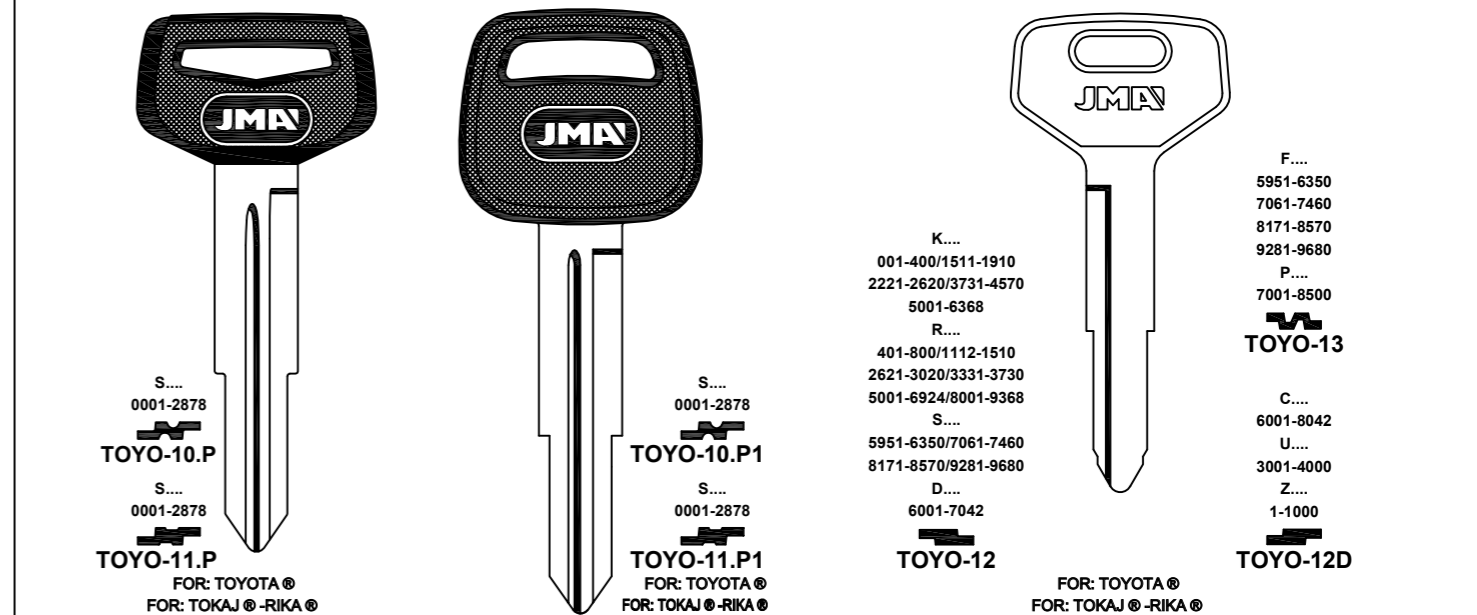

FOR: TOYOTA®

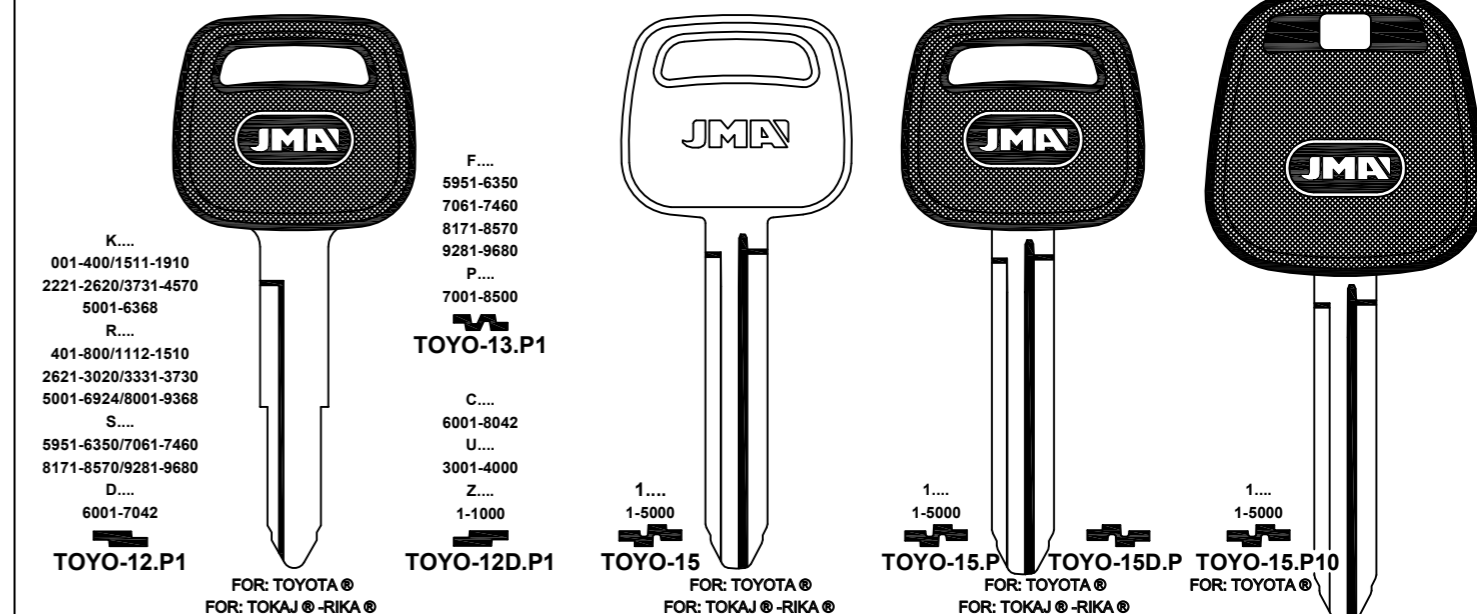

Concerning the marks and commercial denominations see legal warning.
 Concerniente a las marcas y denominaciones comerciales ver aviso legal.
 Marka eta izendapen komertzialiei dagokienez, ikus lege-oharra.
 Concernant les marques et dénominations commerciales voir la note dans l'index.

JMA Opening the future

JMA Opening the future

Beziehen auf die marke und handelsname sehen sie die notiz im Impressum.
 Relativamente às marcas e denominações comerciais, ver aviso legal.
 Jeśli chodzi o znaki i nazwy handlowe, patrz Informacje prawne.

FOR: TOYOTA®

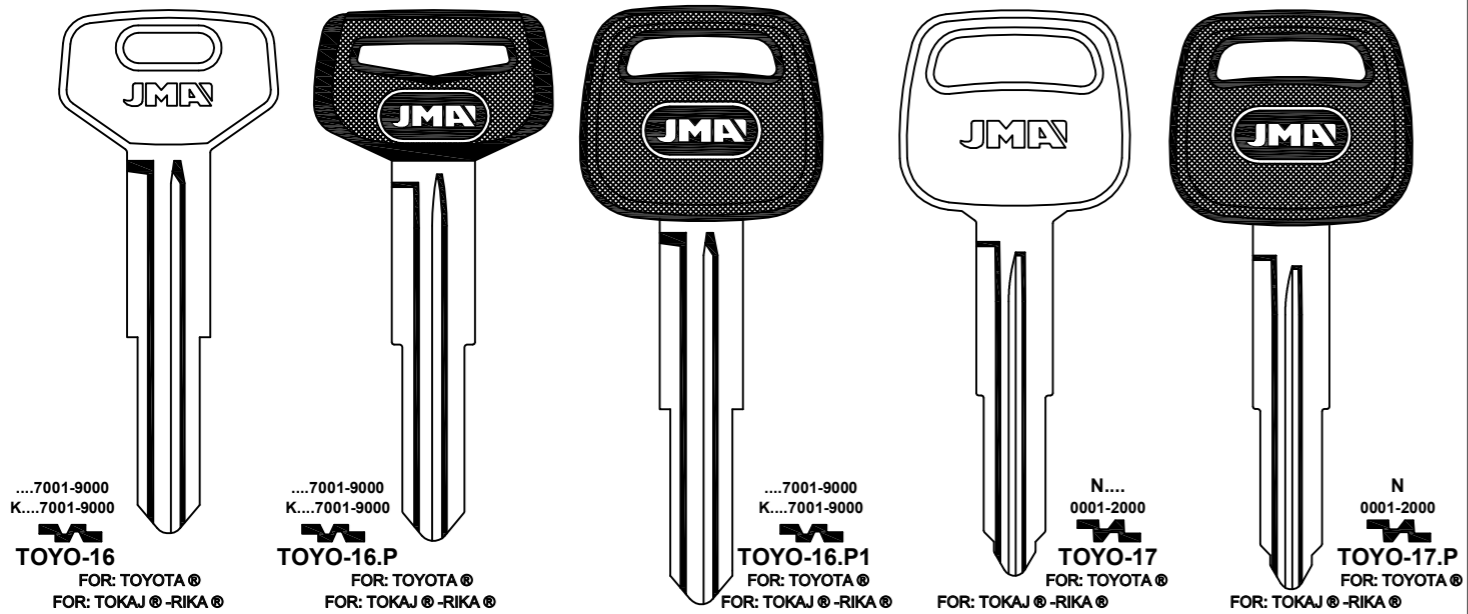

FOR: TOYOTA®

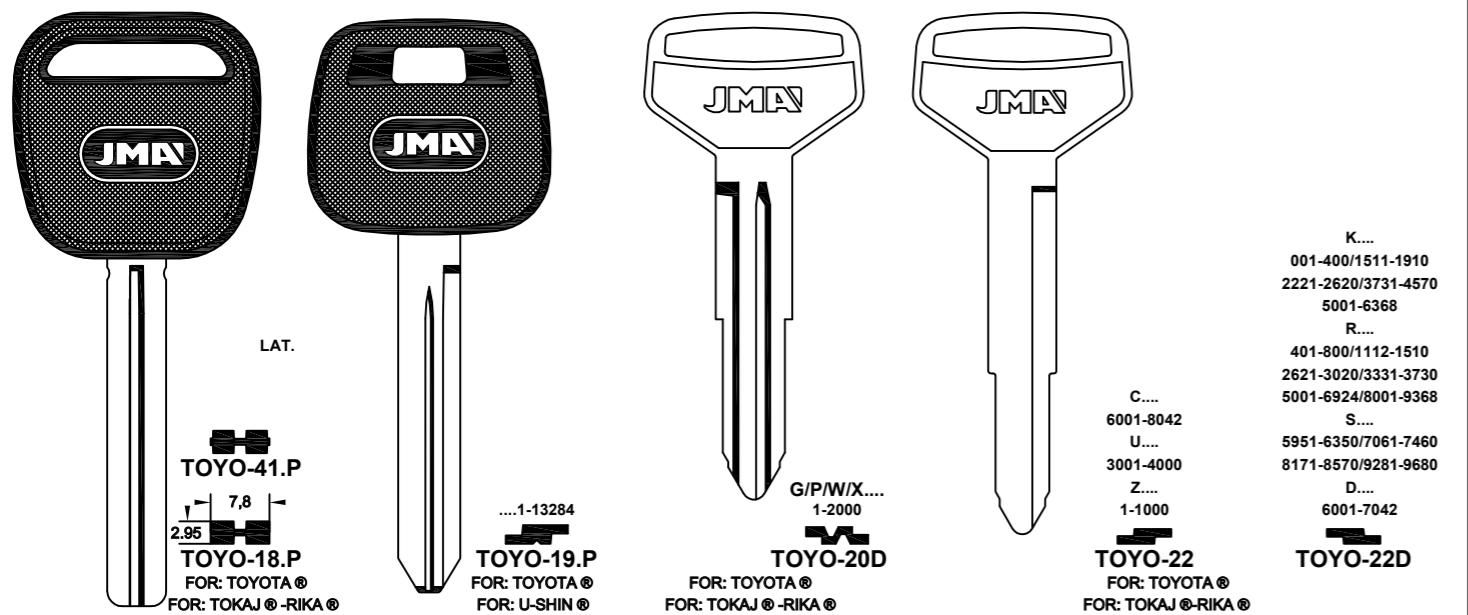

FOR: TOYOTA®

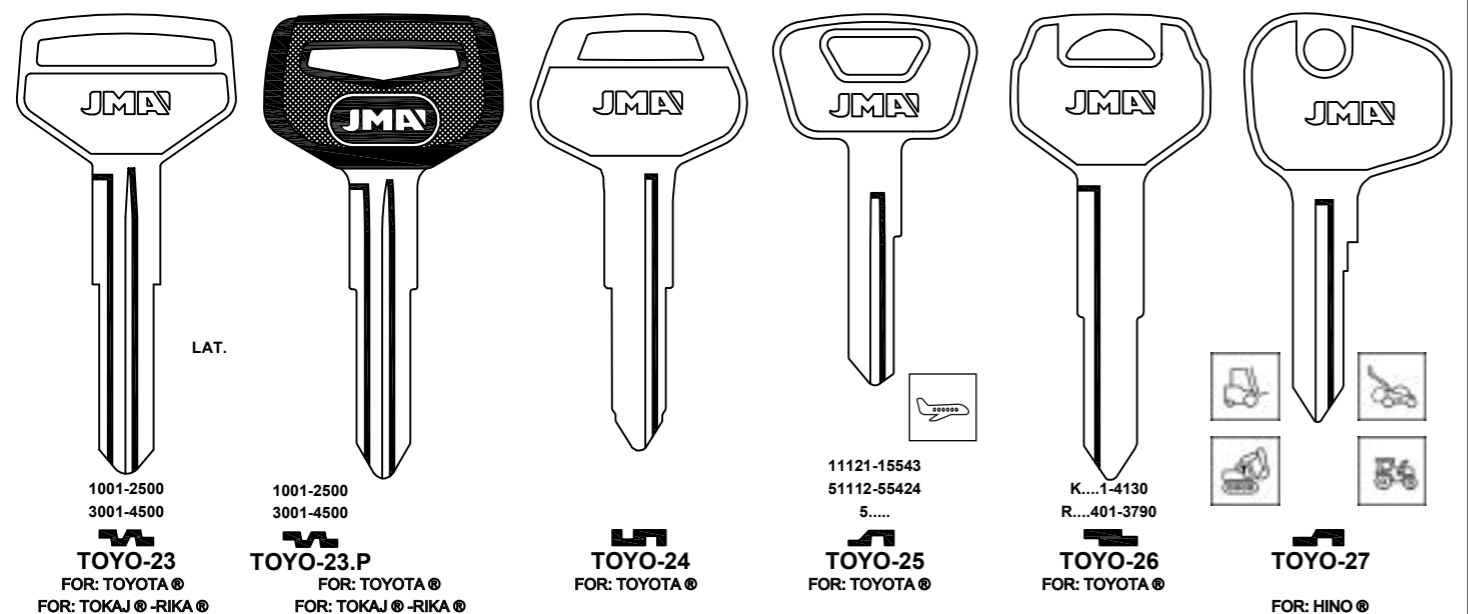

FOR: TOYOTA®

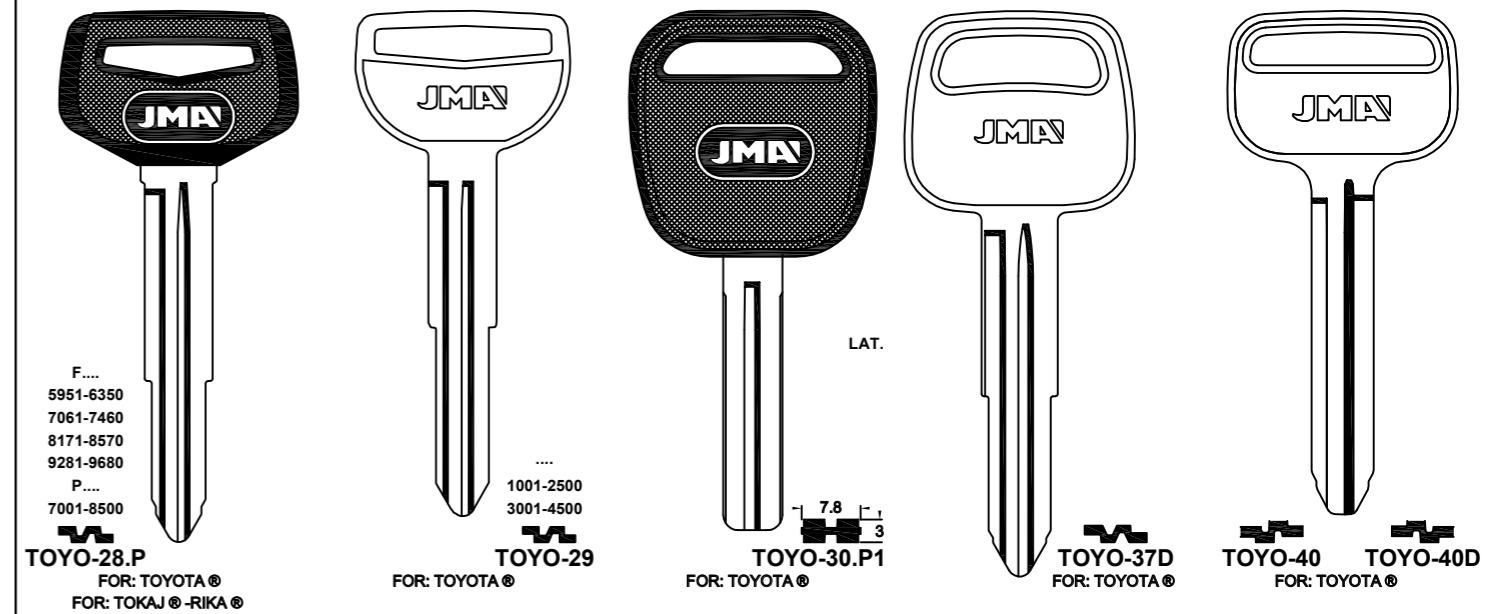

FOR: TRABANT®

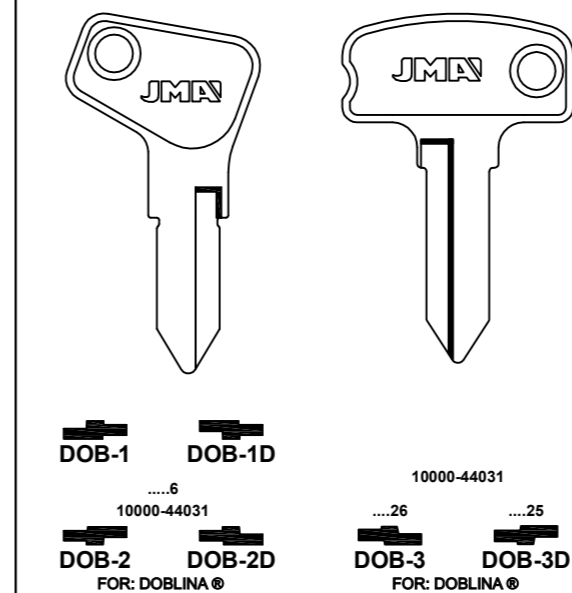

FOR: TRIUMPH®

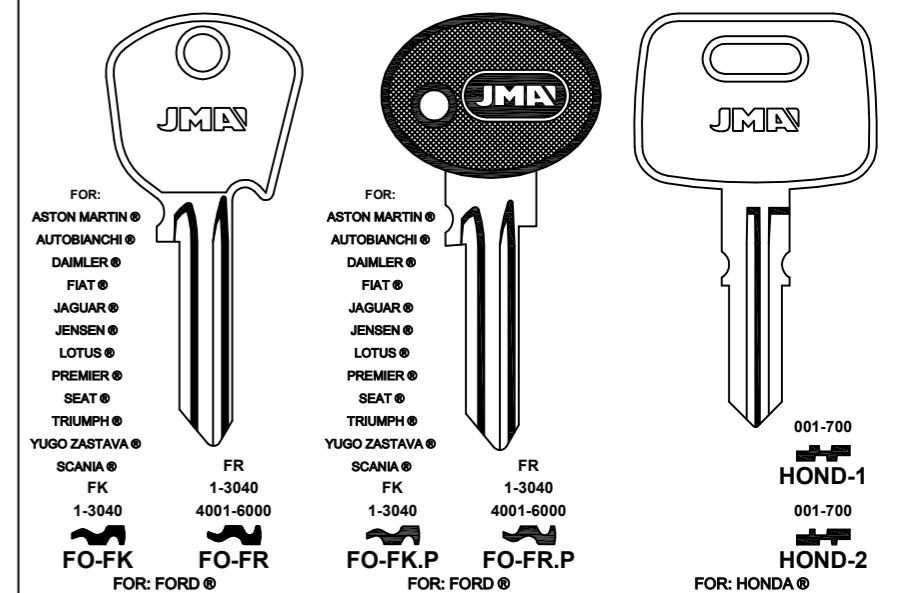

FOR: TRIUMPH®

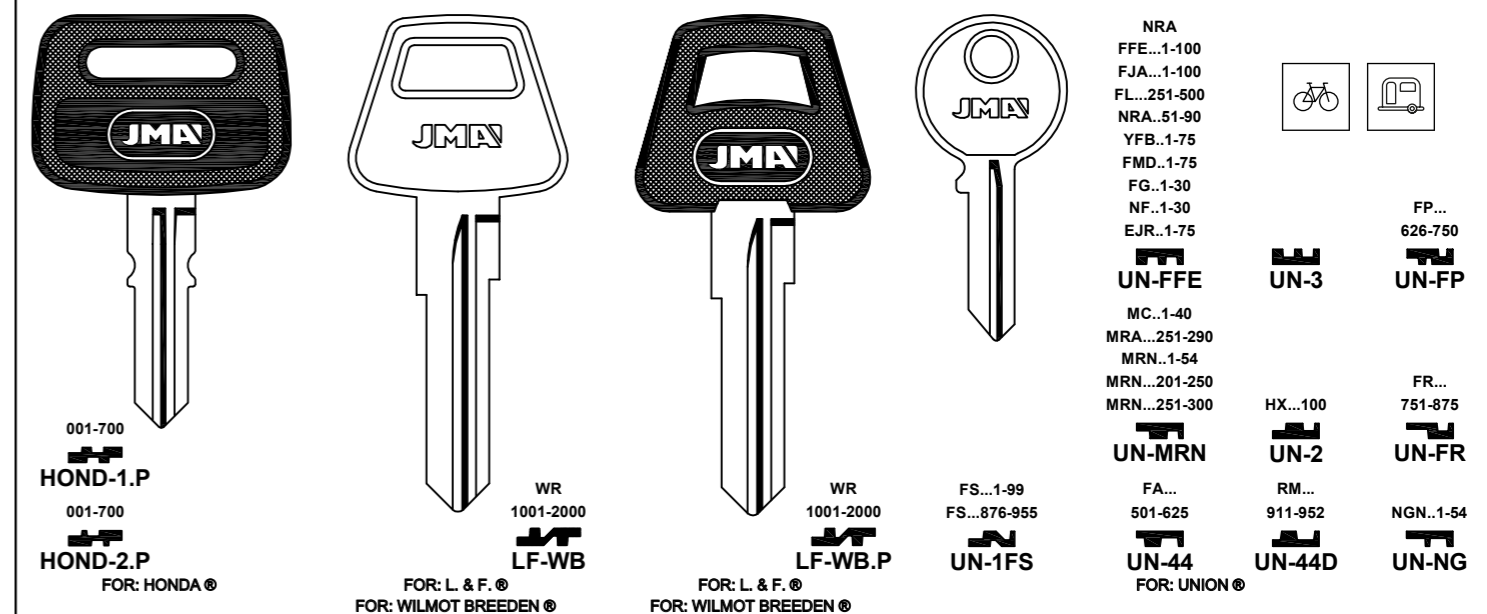

Concerning the marks and commercial denominations see legal warning.
Concerniente a las marcas y denominaciones comerciales ver aviso legal.
Marka eta izendapen komertzialiei dagokienez, ikus lege-oharra.
Concernant les marques et denominations commerciales voir la note dans l'index.

JMA Opening the future

JMA Opening the future

Beziehen auf die Marke und Handelsname sehen Sie die Notiz im Impressum.
Relativamente às marcas e denominações comerciais, ver aviso legal.
Jeśli chodzi o znaki i nazwy handlowe, patrz Informacje prawne.



FOR: TRIUMPH®

FOR: UAZ®

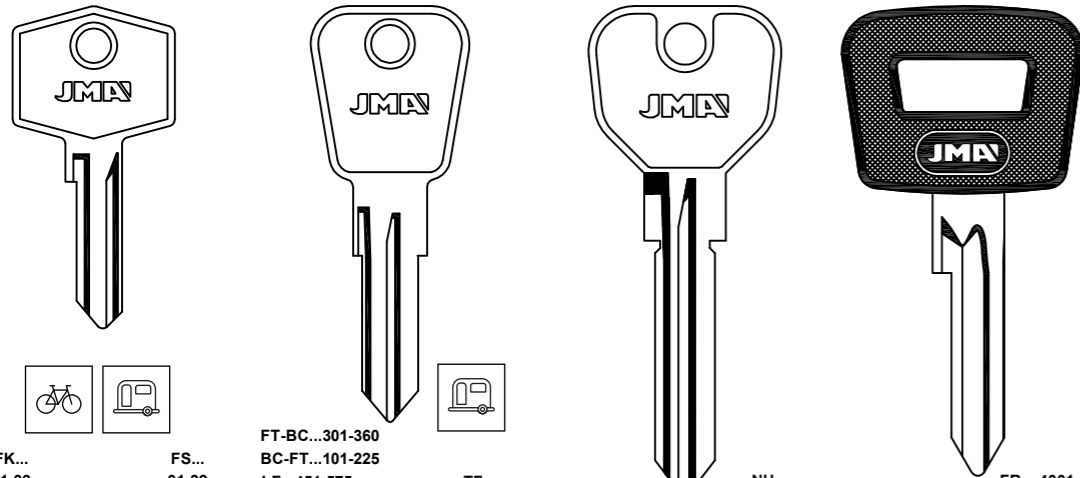

FK... 01-99 876-955
 FS... 01-99 876-955
 FT-BC...301-360
 BC-FT...101-225
 LF...451-575
 CB...801-875
 TF...1001-1140
 NH... 2001-3000
 FR...4001-6000
 FZ...1-1232

UN-FK FOR: UNION®
 FOR: WBH®
 UN-FS FOR: UNION®
 UN-FT FOR: UNION®
 UN-TF FOR: CEM®
 UN-NH FOR: UNION®
 FOR: CEM®
 WAS-2.P FOR: WASO®
 FOR: ARMAN® -DOM®

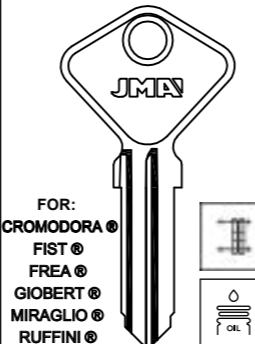

FOR: CROMODORA®
 FIST®
 FREA®
 GIOBERT®
 MIRAGLIO®
 RUFFINI®

6 100-309
 AF-5I
 2 100-309
 AF-6I

8 100-309
 AF-5D
 4 100-309
 AF-6D

FOR: SAFE®

FOR: VAUXHALL®

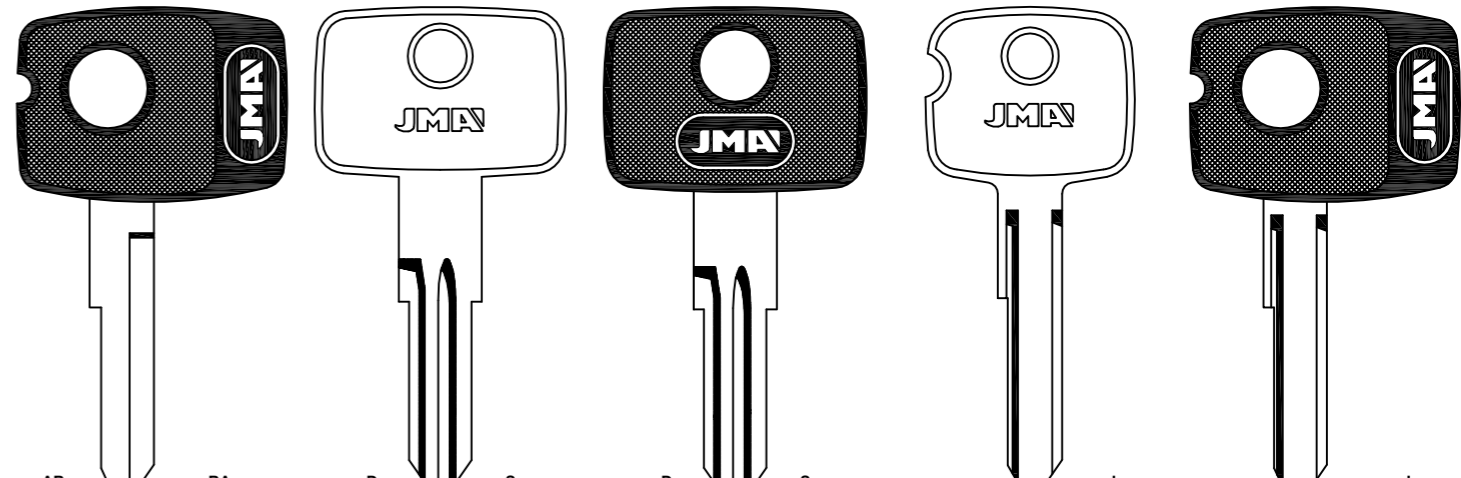

AB... 1-1000
 OP-AB.P FOR: HUF®
 FOR: YMOS®

BA... 1-1000
 OP-BA.P FOR: HUF®
 FOR: YMOS®

D 1-5200
 OP-D FOR: HUF®
 FOR: YMOS®

S... 1-5200
 OP-S FOR: HUF®
 FOR: YMOS®

D 1-5200
 OP-D.P FOR: HUF®
 FOR: YMOS®

S... 1-5200
 OP-S.P FOR: HUF®
 FOR: YMOS®

J... 1-2874
 OP-J FOR: HUF®
 FOR: YMOS®

J... 1-2874
 OP-J.P FOR: HUF®
 FOR: YMOS®

FOR: UAZ®

FOR: VAUXHALL®

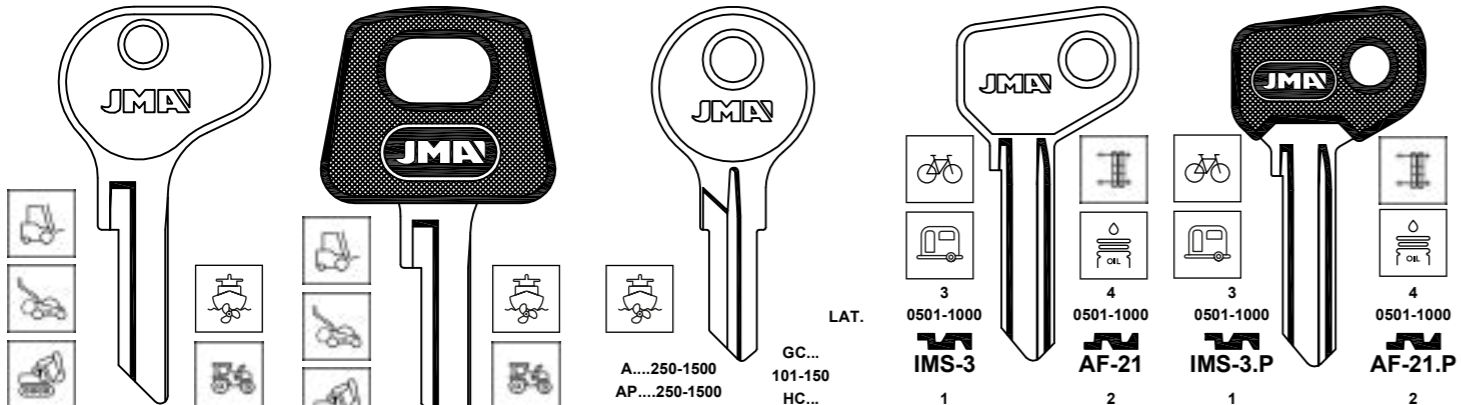

E,M,N,U,H,K 001-100
 HG,N 140-189
 HG 040-100
 BH-1 FOR: BOSCH®
 FOR: NEIMAN®

E,M,N,U,H,K 001-100
 HG,N 140-189
 HG 040-100
 BH-1.P FOR: BOSCH®
 FOR: NEIMAN®

A...250-1500
 AP...250-1500
 B...250-1500
 C...1251-1700
 CB...250-1500
 DC-EP...250-699
 P...250-1500

GC... 101-150
 HC... 0-499
 BS-4D FOR: B & S®

3 0501-1000
 IMS-3 FOR: SAFE®
 FOR: CROMODORA® -FIST® -IMSA®

4 0501-1000
 AF-21 FOR: SAFE®
 FOR: CROMODORA® -FIST® -IMSA®

3 0501-1000
 IMS-3.P FOR: SAFE®
 FOR: CROMODORA® -FIST® -IMSA®

4 0501-1000
 AF-21.P FOR: SAFE®
 FOR: CROMODORA® -FIST® -IMSA®

1 0501-1000
 IMS-5 FOR: SAFE®
 FOR: CROMODORA® -FIST® -IMSA®

2 0501-1000
 AF-19 FOR: SAFE®
 FOR: CROMODORA® -FIST® -IMSA®

1 0501-1000
 IMS-5.P FOR: SAFE®
 FOR: CROMODORA® -FIST® -IMSA®

2 0501-1000
 AF-19.P FOR: SAFE®
 FOR: CROMODORA® -FIST® -IMSA®

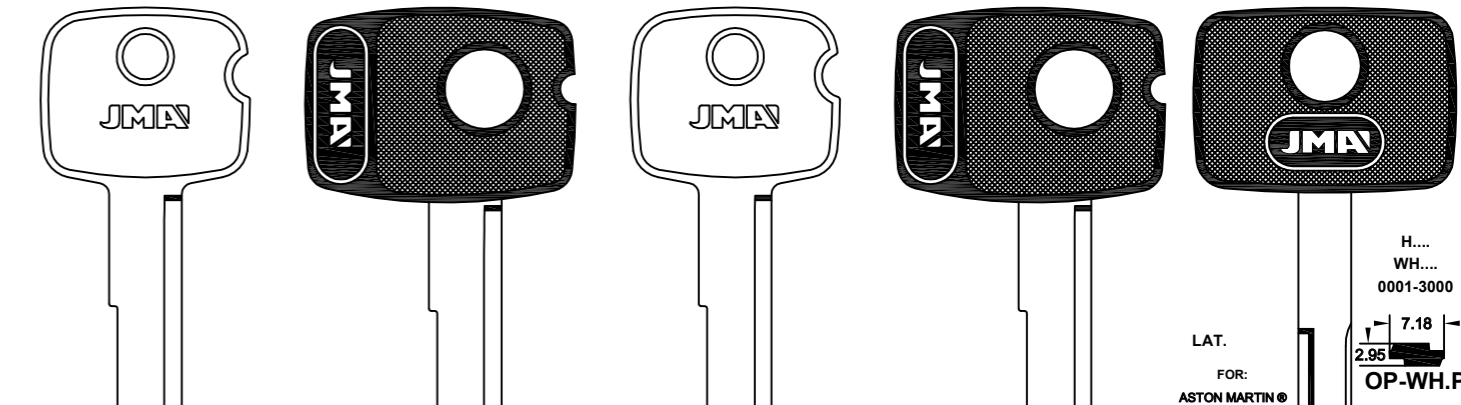

R... 1-1500
 OP-R FOR: HUF®
 FOR: YMOS®

R... 1-1500
 OP-R.P FOR: HUF®
 FOR: YMOS®

T... 1-500
 501-1500
 OP-T FOR: HUF®
 FOR: YMOS®

T... 1-500
 501-1500
 OP-T.P FOR: HUF®
 FOR: YMOS®

H... 0001-3000
 WH... 7.18
 2.95
 OP-WH.P FOR: HUF®
 FOR: YMOS®

WY... 0001-3000
 Y... 6.88
 2.95
 OP-WY.P FOR: HUF®
 FOR: YMOS®

LAT.
 FOR: ASTON MARTIN®
 GM®
 HOLDEN®
 IRMSCHER®
 OPEL®
 VAUXHALL®

FOR: UAZ®

FOR: VAUXHALL®

FOR: VOLGA®

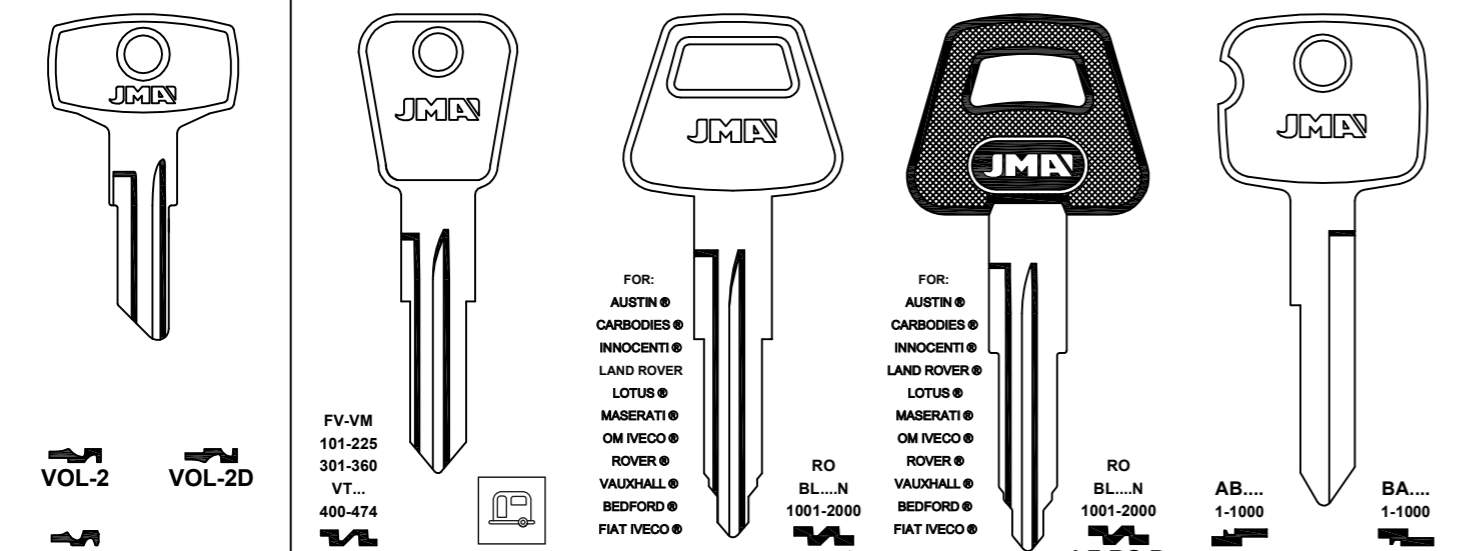

VOL-2 FOR: VOLGA®
 FOR: GAZ® -ZAZ®

VOL-3 FOR: VOLGA®
 FOR: GAZ® -ZAZ®

FV-VM 101-225 301-360
 VT... 400-474
 LF-6 FOR: L. & F.®

FOR: AUSTIN®
 CARBODIES®
 INNOCENTI®
 LAND ROVER®
 LOTUS®
 MASERATI®
 OM IVECO®
 ROVER®
 VAUXHALL®
 BEDFORD®
 FIAT IVECO®

RO BL...N 1001-2000
 LF-RO FOR: L. & F.®

FOR: AUSTIN®
 CARBODIES®
 INNOCENTI®
 LAND ROVER®
 LOTUS®
 MASERATI®
 OM IVECO®
 ROVER®
 VAUXHALL®
 BEDFORD®
 FIAT IVECO®

RO BL...N 1001-2000
 LF-RO.P FOR: L. & F.®

AB... 1-1000
 OP-AB FOR: HUF®
 FOR: YMOS®

BA... 1-1000
 OP-BA FOR: HUF®
 FOR: YMOS®

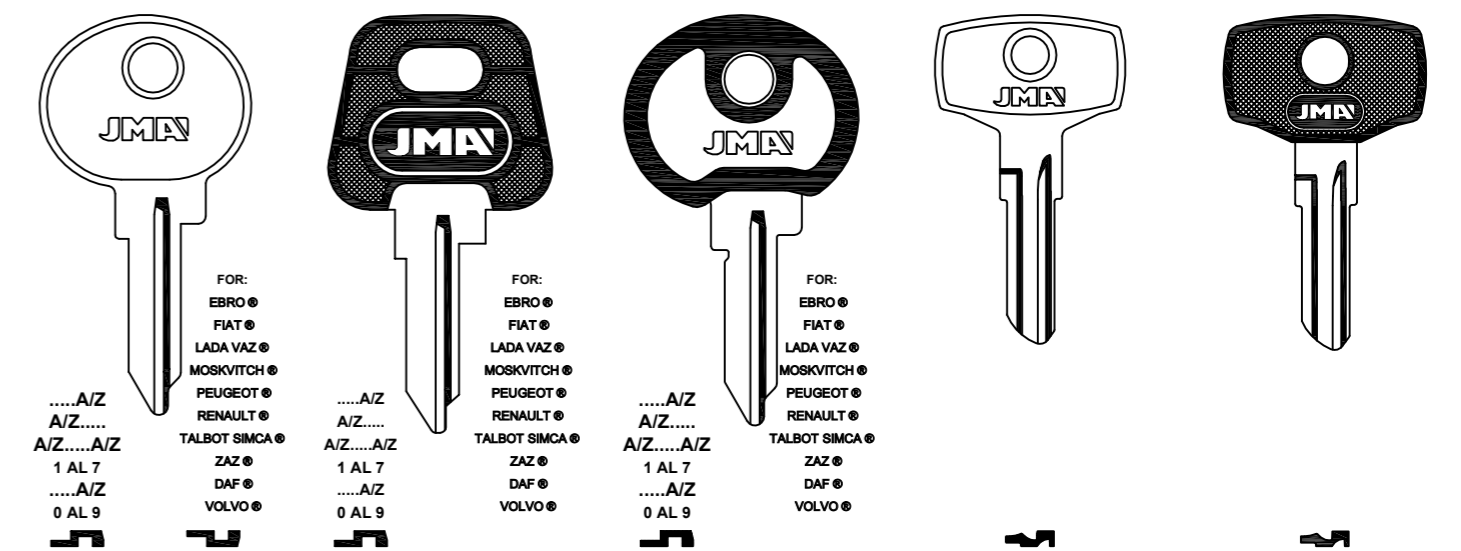

...A/Z
 A/Z...
 A/Z...A/Z
 1 AL 7
 ...A/Z
 0 AL 9
 NE-3 FOR: NEIMAN®
 FOR: CLAUSOR®

...A/Z
 A/Z...
 A/Z...A/Z
 1 AL 7
 ...A/Z
 0 AL 9
 NE-3D FOR: NEIMAN®
 FOR: CLAUSOR®

...A/Z
 A/Z...
 A/Z...A/Z
 1 AL 7
 ...A/Z
 0 AL 9
 NE-3.P FOR: NEIMAN®
 FOR: CLAUSOR®

...A/Z
 A/Z...
 A/Z...A/Z
 1 AL 7
 ...A/Z
 0 AL 9
 NE-3.P2 FOR: NEIMAN®
 FOR: CLAUSOR®

VOL-1 FOR: VOLGA®

VOL-1.P FOR: VOLGA®

Concerning the marks and commercial denominations see legal warning.
 Concerniente a las marcas y denominaciones comerciales ver aviso legal.
 Marka eta izendapen komertzialiei dagokienez, ikus lege-oharra.
 Concernant les marques et denominations commerciales voir la note dans l'index.



Beziehen auf die marke und handelsname sehen sie die notiz im Impressum.
 Relativamente às marcas e denominações comerciais, ver aviso legal.
 Jeśli chodzi o znaki i nazwy handlowe, patrz Informacje prawne.

FOR: VOLGA®

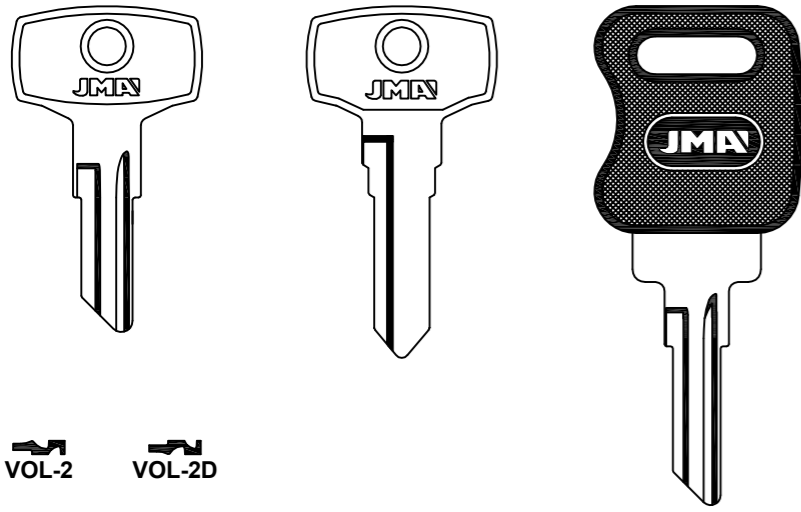

VOL-2 VOL-2D
VOL-3 FOR: VOLGA®
FOR: GAZ®-ZAZ®
VOL-4 FOR: VOLGA®
VOL-5.P FOR: VOLGA®

FOR: VOLKSWAGEN®

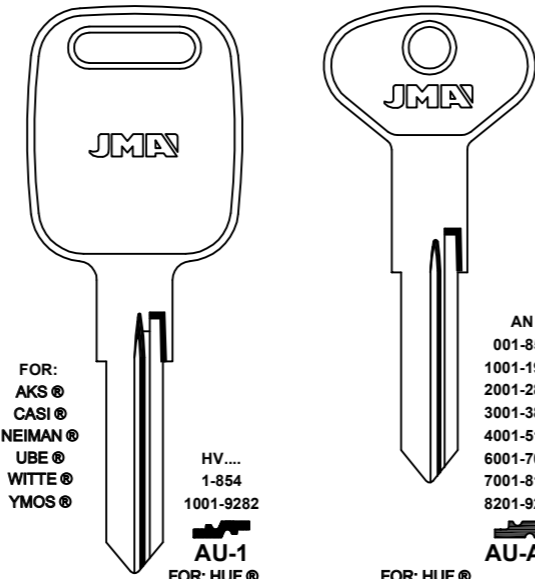

AN
001-854
1001-1918
2001-2830
3001-3890
4001-5151
6001-7086
7001-8154
8201-9282
FOR: AKS®
FOR: CASI®
FOR: NEIMAN®
FOR: UBE®
FOR: WITTE®
FOR: YMOS®
HV...
1-854
1001-9282
AU-1 FOR: HUF®
AU-AN FOR: HUF®
FOR: AKS®-CASI®-UBE®-WITTE®

FOR: VOLKSWAGEN®

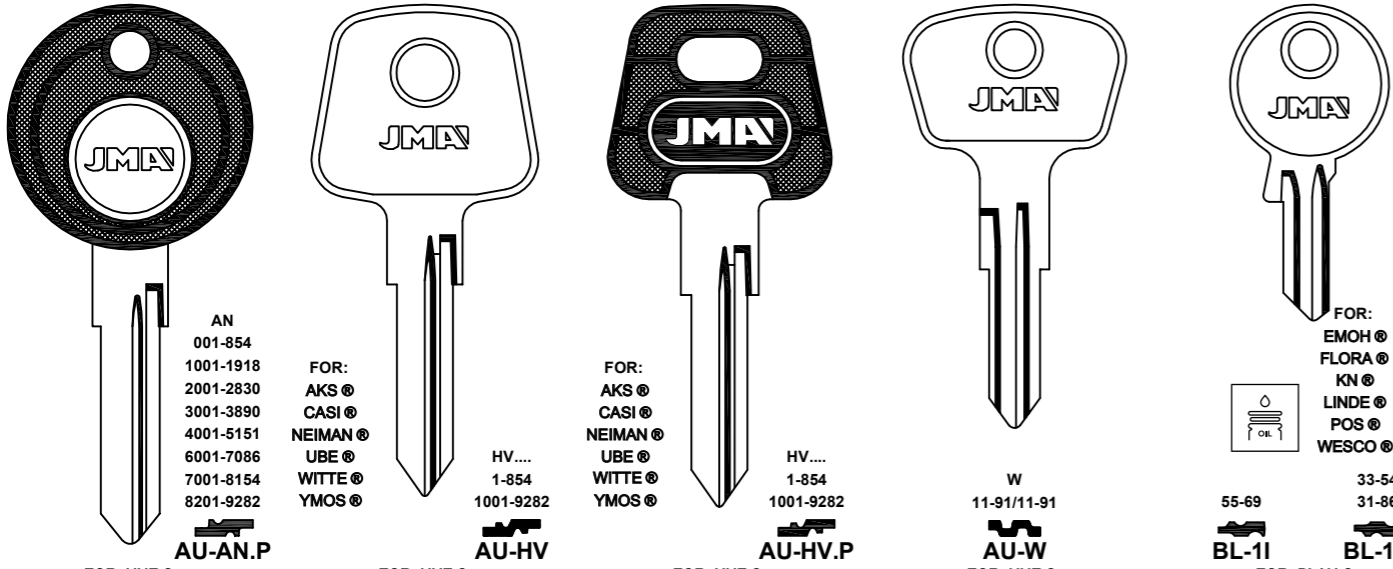

AN
001-854
1001-1918
2001-2830
3001-3890
4001-5151
6001-7086
7001-8154
8201-9282
FOR: HUF®
FOR: AKS®-CASI®-UBE®-WITTE®
FOR: AKS®
FOR: CASI®
FOR: NEIMAN®
FOR: UBE®
FOR: WITTE®
FOR: YMOS®
HV...
1-854
1001-9282
AU-HV FOR: HUF®
FOR: AKS®
FOR: CASI®
FOR: NEIMAN®
FOR: UBE®
FOR: WITTE®
FOR: YMOS®
HV...
1-854
1001-9282
AU-HV.P FOR: HUF®
W
11-91/11-91
AU-W FOR: HUF®
FOR: AKS®-WITTE®
33-54
31-86
BL-1 FOR: BLAU®
BL-1D FOR: BLAU®

FOR: VOLKSWAGEN®

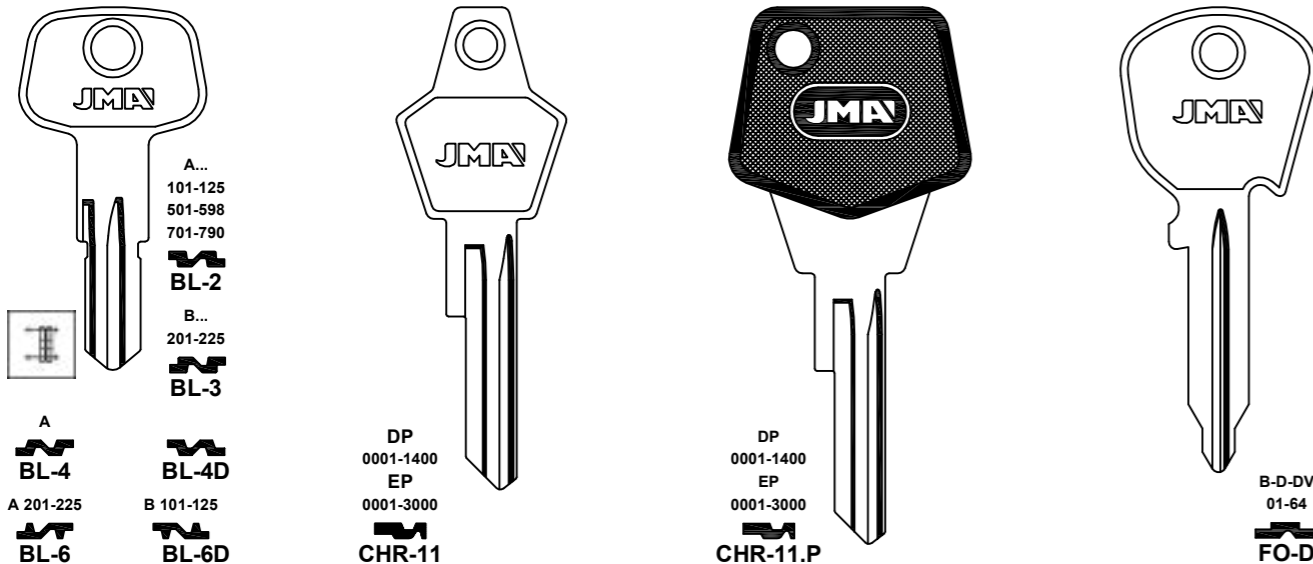

A...
101-125
501-598
701-790
BL-2
B...
201-225
BL-3
A
BL-4
A 201-225 B 101-125
BL-6 BL-6D
FOR: BLAU®
FOR: FORT®-HK®-WASO®
DP
0001-1400
EP
0001-3000
CHR-11 FOR: CHRYSLER®
FOR: YALE®
DP
0001-1400
EP
0001-3000
CHR-11.P FOR: CHRYSLER®
FOR: YALE®
B-D-DV
01-64
FO-D FOR: FORD®
FOR: BRITAX®-KOLB®

FOR: FERRARI®

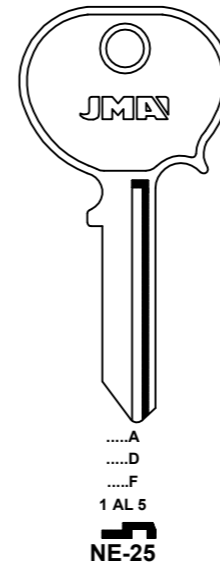

.....A
.....D
.....F
1 AL 5
NE-25 FOR: NEIMAN®

FOR: FIAT®

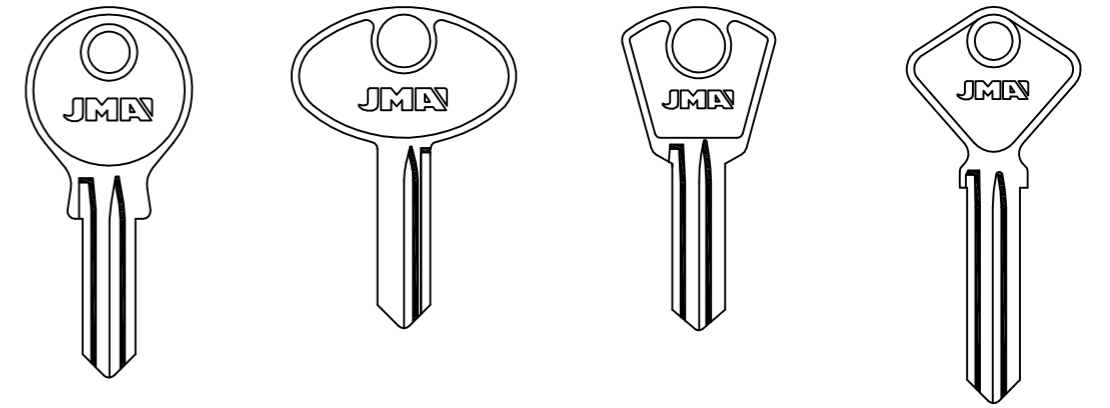

A
001-125
AF-1I FOR: SAFE®
FOR: SIPEA®-MAGNETI MARELLI®
B
001-125
AF-1D FOR: SAFE®
FOR: SIPEA®-MAGNETI MARELLI®
D
1-125
AF-2I FOR: SAFE®
FOR: SIPEA®-MAGNETI MARELLI®
C
1-125
AF-2D FOR: SAFE®
FOR: SIPEA®-MAGNETI MARELLI®
S
615-699
712-799
812-899
AF-4I FOR: SAFE®
FOR: FIST®-TRAMA®
D
115-199
212-299
312-399
AF-4D FOR: SAFE®
FOR: FIST®-TRAMA®

FOR: FIAT®

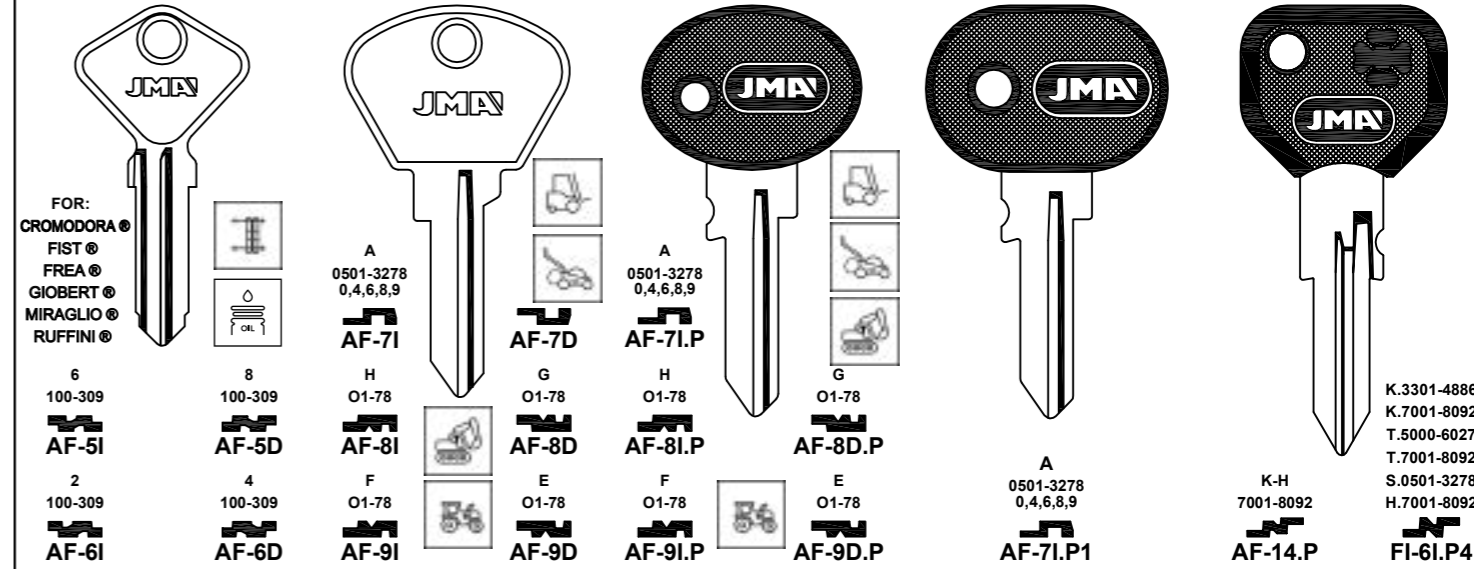

FOR: CROMODORA®
FOR: FIST®
FOR: FREA®
FOR: GIOBERT®
FOR: MIRAGLIO®
FOR: RUFFINI®
A
0501-3278
0,4,6,8,9
AF-7I FOR: SAFE®
AF-7D FOR: SAFE®
AF-7I.P FOR: SAFE®
AF-7D.P FOR: SAFE®
H
01-78
AF-8I FOR: SIPEA®
FOR: SAFE®
G
01-78
AF-8D FOR: SIPEA®
FOR: SAFE®
AF-8I.P FOR: SIPEA®
FOR: SAFE®
AF-8D.P FOR: SIPEA®
FOR: SAFE®
A
0501-3278
0,4,6,8,9
AF-7I.P1 FOR: SIPEA®
FOR: NEIMAN®
K-H
7001-8092
AF-14.P FOR: GIOBERT®
FOR: FIST®-M.MARELLI®-NEIMAN®-SIPEA®
K.3301-4886
K.7001-8092
T.5000-6027
T.7001-8092
S.0501-3278
H.7001-8092

FOR: FIAT®

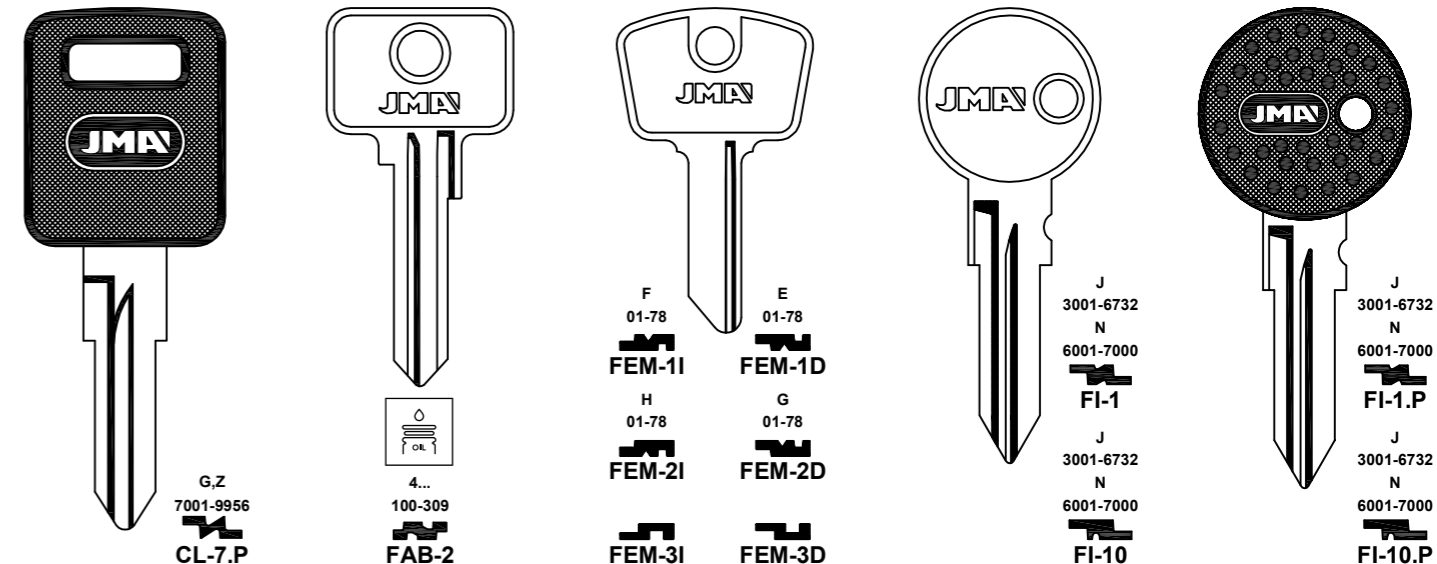

G,Z
7001-9956
CL-7.P FOR: CLAUSOR®
FOR: GIOBERT®
4...
100-309
FAB-2 FOR: FAAB®
F
01-78
FEM-1I FOR: FEMSA®
H
01-78
FEM-2I FOR: FEMSA®
E
01-78
FEM-1D FOR: FEMSA®
G
01-78
FEM-2D FOR: FEMSA®
J
3001-6732
N
6001-7000
FI-1 FOR: GIOBERT®
FOR: GIOBERT®
J
3001-6732
N
6001-7000
FI-10 FOR: GIOBERT®
FOR: GIOBERT®
J
3001-6732
N
6001-7000
FI-1.P FOR: GIOBERT®
FOR: GIOBERT®

Concerning the marks and commercial denominations see legal warning.
Concerniente a las marcas y denominaciones comerciales ver aviso legal.
Marka eta izendapen komertzialiei dagokienez, ikus lege-oharra.
Concernant les marques et dénominations commerciales voir la note dans l'index.

JMA Opening the future

JMA Opening the future

Beziehen auf die Marke und Handelsname sehen sie die Notiz im Impressum.
Relativamente às marcas e denominações comerciais, ver aviso legal.
Jeśli chodzi o znaki i nazwy handlowe, patrz Informacje prawne.

FOR: FIAT®

Z-GR
 7001-9956
FI-2D
 G
 2001-4530
 G-Z
 7001-9956
FI-3D
 G
 7001-9956
FI-12
 FOR: GIOBERT®

Z-GR
 7001-9956
FI-2D.P3
 G
 2001-4530
 G-Z
 7001-9956
FI-3D.P3
 G
 7001-9956
FI-12.P3
 FOR: GIOBERT®

FOR:
 ALFA ROMEO®
 CITROEN®
 FIAT®
 INNOCENTI®
 LANCIA®
 SEAT®
 YUGO ZASTAVA®

G
 2001-4530
 G-Z
 7001-9956
FI-3D.P
 FOR: GIOBERT®

FOR:
 ALFA ROMEO®
 FIAT IVECO®

G
 2001-4530
 G-Z
 7001-9956
FI-3D.P1
 G
 7001-9956
FI-12.P1
 FOR: GIOBERT®

G
 2001-4530
 G-Z
 7001-9956
FI-3D.P2
 FOR: GIOBERT®

FOR: FIAT®

G
 2001-4530
 G-Z
 7001-9956
FI-3D.P4
 FOR: GIOBERT®

G
 2001-4530
 G-Z
 7001-9956
FI-3D.P5
 FOR: GIOBERT®

K 3301-4886
K 7001-8092
T 5000-6027
T 7001-8092
S 0501-3278
H 7001-8092
FI-6I
 FOR: GIOBERT®

FOR:
 ALFA ROMEO®
 AUTOBIANCHI®
 CITROEN®
 FERRARI®
 FIAT®
 INNOCENTI®
 LANCIA®
 PEUGEOT®
 YUGO ZASTAVA®
 CAGIVA®
 DUCATI®
 FANTIC MOTOR®
 GARELLI®
 GILERA®

K 3301-4886
K 7001-8092
T 5000-6027
T 7001-8092
S 0501-3278
H 7001-8092
FI-6I.P
 FOR: GIOBERT®

FOR:
 FERRARI®
 FIAT®
 INNOCENTI®
 LANCIA®

K 3301-4886
K 7001-8092
T 5000-6027
T 7001-8092
S 0501-3278
H 7001-8092
FI-6I.P2
 FOR: GIOBERT®

FOR:
 FERRARI®
 FIAT®
 CAGIVA®

FOR: FIAT®

X
 3301-4886
FI-7I
 FOR: GIOBERT®
 FOR: NEIMAN®-SIPA®

Y
 7001-9956
FI-8I
 FOR: GIOBERT®
 FOR: ARMAN®

Y
 7001-9956
FI-8I.P
 FOR: GIOBERT®
 FOR: ARMAN®

Y
 7001-9956
FI-8I.P1
 FOR: GIOBERT®
 FOR: ARMAN®

M
 0001-1050
FI-9I
 FOR: GIOBERT®

FOR: FIAT®

M
 0001-1050
FI-9I.P
 FOR: GIOBERT®

N 6001-7000
J 3001-6732
V 0001-3051
V 5001-8058
AB 6001-6891
FI-11
 FOR: GIOBERT®

N 6001-7000
J 3001-6732
V 0001-3051
V 5001-8058
AB 6001-6891
FI-11.P
 FOR: GIOBERT®

W
 0001-9640
FI-13
 FOR: GIOBERT®

W
 0001-9640
FI-13.P
 FOR: GIOBERT®

FOR: RAYTON FISSORE®-STEYR PUCH®-APRILIA®
 FOR: RAYTON FISSORE®-STEYR PUCH®-APRILIA®
 FOR: ALFA ROMEO®-FIAT®-LANCIA®
 FOR: ALFA ROMEO®-FIAT®-LANCIA®

FOR: FIAT®

W
 0001-9640
FI-13.P1
 FOR: GIOBERT®

W
 0001-9640
FI-14.P
 FOR: GIOBERT®

FI-15
 FOR: GIOBERT®

FIA-2
 FOR: FIAT®

FR
 1-3040
FO-FK
 FOR: ARMAN®-DOM®-JUGODENT®-WASO®

FR
 1-3040
FO-FR
 FOR: FORD®

FOR:
 ASTON MARTIN®
 AUTOBIANCHI®
 DAIMLER®
 FIAT®
 JAGUAR®
 JENSEN®
 LOTUS®
 PREMIER®
 SEAT®
 TRIUMPH®
 YUGO ZASTAVA®
 SCANIA®
 FK
 1-3040
 4001-6000

FOR: FIAT®

FOR:
 ASTON MARTIN®
 AUTOBIANCHI®
 DAIMLER®
 FIAT®
 JAGUAR®
 JENSEN®
 LOTUS®
 PREMIER®
 SEAT®
 TRIUMPH®
 YUGO ZASTAVA®
 SCANIA®
 FK
 1-3040
 4001-6000
FO-FK.P
 FOR: FORD®

FR
 1-3040
FO-FR.P
 FOR: FORD®

3
 0501-1000
IMS-3
 FOR: SAFE®

4
 0501-1000
AF-21
 FOR: CROMODORA®-FIST®-IMSA®

3
 0501-1000
IMS-3.P
 FOR: SAFE®

4
 0501-1000
AF-21.P
 FOR: CROMODORA®-FIST®-IMSA®

1
 0501-1000
IMS-5
 FOR: SAFE®

2
 0501-1000
AF-19
 FOR: CROMODORA®-FIST®-IMSA®

1
 0501-1000
IMS-5.P
 FOR: SAFE®

2
 0501-1000
AF-19.P
 FOR: CROMODORA®-FIST®-IMSA®

1
 0501-1000
IMS-12
 FOR: IMSA®
 FOR: SAFE®

FOR: NEIMAN®
FOR: CLAUSSOR®

FOR: EBRO®
 FIAT®
 LADA VAZ®
 MOSKVITCH®
 PEUGEOT®
 RENAULT®
 TALBOT SIMCA®
 ZAZ®
 DAF®
 VOLVO®

Concerning the marks and commercial denominations see legal warning.
 Concerniente a las marcas y denominaciones comerciales ver aviso legal.
 Marka eta izendapen komertzialiei dagokienez, ikus lege-oharra.
 Concernant les marques et denominations commerciales voir la note dans l'index.

JMA Opening the future

JMA Opening the future

Beziehen auf die marke und handelsname sehen sie die notiz im Impressum.
 Relativamente às marcas e denominações comerciais, ver aviso legal.
 Jeśli chodzi o znaki i nazwy handlowe, patrz Informacje prawne.

FOR: FIAT ®

FOR: EBRO®
FIAT®
LADA VAZ®
MOSKVITCH®
PEUGEOT®
RENAULT®
TALBOT SIMCA®
ZAZ®
DAF®
VOLVO®

.....A/Z
A/Z.....
A/Z.....A/Z
1 AL 7
.....A/Z
0 AL 9

NE-3.P
FOR: NEIMAN®
FOR: CLAUSOR®

FOR: EBRO®
FIAT®
LADA VAZ®
MOSKVITCH®
PEUGEOT®
RENAULT®
TALBOT SIMCA®
ZAZ®
DAF®
VOLVO®

.....A/Z
A/Z.....
A/Z.....A/Z
1 AL 7
.....A/Z
0 AL 9

NE-3.P2
FOR: NEIMAN®
FOR: CLAUSOR®

FOR: EBRO®
FIAT®
LADA VAZ®
MOSKVITCH®
PEUGEOT®
RENAULT®
TALBOT SIMCA®
ZAZ®
DAF®
VOLVO®

NE-47
FOR: NEIMAN (RA)®

SI-3
SI-3D
SI-2D
FOR: SISPA®
FOR: AUTOBLOCK®

.....4-6-8-9
SIP-2
FOR: SIPEA®
FOR: MAGNETI MARELLI® - NEIMAN®

FOR: VOLKSWAGEN (BRASIL) ®

J...
001-224
PJ-2.P
FOR: PJ®
FOR: KIFERM®

AH....
1-8154
1001-9282
VO-2
FOR: HUF®
FOR: AKS® -CASI® -UBE® -WITTE®

HV....
1-8154
1001-9282
VO-HV.P1
2FF
VO-8.P
AH....
1-8154
1001-9282
VO-2.P
FOR: HUF®
FOR: AKS® -CASI® -UBE® -WITTE®

VO-2D.P
FOR: HUF®

FOR: FIAT ®

FOR: FIAT (ARGENTINA) ®

B....01-3278
B....0-4-6-8-9
SIP-3
FOR: SIPEA®
FOR: ARTEB® -CLAUSOR® -NEIMAN®

0111111
FOR: AL®
628888
SIX-3.P1
FOR: SIMPLEX®

FOR: CROMODORA®
FIST®
FREA®
GIOBERT®
MIRAGLIO®
RUFFINI®

6
100-309
AF-5I

8
100-309
AF-5D

2
100-309
AF-6I

A
0501-3278
0,4,6,8,9
AF-7I

H
01-78
AF-8I

F
01-78
AF-9I

G
01-78
AF-7D

G
01-78
AF-8D

E
01-78
AF-9D

A
0501-3278
0,4,6,8,9
AF-7I.P

H
01-78
AF-8I.P

F
01-78
AF-9I.P

G
01-78
AF-8D.P

E
01-78
AF-9D.P

FOR: SIPEA®
FOR: SAFE®

FOR: SIPEA®
FOR: SAFE®

FOR: SIPEA®
FOR: SAFE®

FOR: VOLKSWAGEN (BRASIL) ®

FOR: VOLKSWAGEN (CH) ®

AH....
1-8154
1001-9282
VO-AH

HV....
1-8154
1001-9282
VO-HV

VB-NV-MD....
1-8154
1001-9282
VO-VB

N....
VO-N

FOR: HUF®
FOR: AKS® -CASI® -UBE® -WITTE®

AH....
1-8154
1001-9282
VO-AH.P

HV....
1-8154
1001-9282
VO-HV.P

VB-NV-MD....
1-8154
1001-9282
VO-VB.P

N....
VO-N.P

FOR: HUF®
FOR: AKS® -CASI® -UBE® -WITTE®

AN....
001-854
1001-1918
2001-2830
3001-3890
4001-5151
6001-7086
7001-8154
8201-9282
AU-AN

AN....
001-854
1001-1918
2001-2830
3001-3890
4001-5151
6001-7086
7001-8154
8201-9282
AU-AN.P

FOR: HUF®
FOR: AKS® -CASI® -UBE® -WITTE®

FOR: HUF®
FOR: AKS® -CASI® -UBE® -WITTE®

HV....
1-854
1001-9282
AU-1
FOR: HUF®

FOR: AKS®
CASI®
NEIMAN®
UBE®
WITTE®
YMOS®

FOR: FIAT (ARGETINA) ®

FOR: VOLKSWAGEN (CHINA) ®

J
3001-6732
N
6001-7000
FI-1

J
3001-6732
N
6001-7000
FI-1.P

J
3001-6732
N
6001-7000
FI-10

FOR: GIOBERT®

FOR: GIOBERT®

FOR: GIOBERT®

Y
7001-9956
FI-8I

Y
7001-9956
FI-8I.P

M
0001-1050
FI-9I

FOR: GIOBERT®
FOR: ARMAN®

FOR: GIOBERT®
FOR: ARMAN®

FOR: GIOBERT®

AN
001-854
1001-1918
2001-2830
3001-3890
4001-5151
6001-7086
7001-8154
8201-9282
AU-AN

FOR: HUF®
FOR: AKS® -CASI® -UBE® -WITTE®

AN
001-854
1001-1918
2001-2830
3001-3890
4001-5151
6001-7086
7001-8154
8201-9282
AU-AN.P

FOR: HUF®
FOR: AKS® -CASI® -UBE® -WITTE®

FOR: AKS®
CASI®
NEIMAN®
UBE®
WITTE®
YMOS®

HV....
1-854
1001-9282
AU-HV

FOR: HUF®

FOR: AKS®
CASI®
NEIMAN®
UBE®
WITTE®
YMOS®

HV....
1-854
1001-9282
AU-HV.P

FOR: HUF®

FOR: EMOH®
FLORA®
KN®
LINDE®
POS®
WESCO®

55-69
BL-1I

33-54
BL-1D

FOR: BLAU®

Concerning the marks and commercial denominations see legal warning.
Concieniente a las marcas y denominaciones comerciales ver aviso legal.
Marka eta izendapen komertzialiei dagokienez, ikus lege-oharra.
Concernant les marques et denominations commerciales voir la note dans l'index.

JMA Opening the future

JMA Opening the future

Beziehen auf die marke und handelsname sehen sie die notiz im Impressum.
Relativamente às marcas e denominações comerciais, ver aviso legal.
Jeśli chodzi o znaki i nazwy handlowe, patrz Informacje prawne.

FOR: VOLKSWAGEN (CHINA) ®

A...
101-125
501-598
701-790
BL-2

B...
201-225
BL-3

A
BL-4

A 201-225
BL-6

FOR: BLAU ®
FOR: FORT ® -HK ® -WASO ®

DA-OA
001-210
ER-PN
101-295
ER
001-195
ER
501-695
FO-OA

FOR: FORD ®
FOR: CASI ® -HUF ® -YMOS ®

OL
001-210
07R
001-195
7OR
001-210
FO-OL

O7L
001-195
7OL
001-210
OR
001-210
FO-OR

FOR: CASI ® -YMOS ®

FB
001-210
PO
501-695
PO
101-295
FO-PN

FOR: FORD ®
FOR: AKS ® -CASI ® -UBE ® -WITTE ®

AN
001-854
1001-1918
2001-2830
3001-3890
4001-5151
6001-7086
7001-8154
8201-9282
HU-AN

FOR: FORD ®
FOR: AKS ® -CASI ® -UBE ® -WITTE ®

J...
001-224
PJ-1

FOR: PJ ®
FOR: KIFERM ®

FOR: VOLKSWAGEN (CHINA) ®

J...
001-224
PJ-2

FOR: PJ ®
FOR: KIFERM ®

J...
001-224
PJ-2.P

FOR: PJ ®
FOR: KIFERM ®

AH...
1-8154
1001-9282
VO-2

FOR: HUF ®
FOR: AKS ® -CASI ® -UBE ® -WITTE ®

HV...
1-8154
1001-9282
VO-HV.P1

2FF
VO-8.P

AH...
1-8154
1001-9282
VO-2.P

FOR: HUF ®
FOR: AKS ® -CASI ® -UBE ® -WITTE ®

8...
1...
1001-3300
AS-1D

7...
6...
1001-3300
AS-24

FOR: ASSA ®

JC
001-852
CEM-JC

AK
0001-1000
FO-5

FOR: CEM ®

A...201-1050
C...500-699
H...601-1100
HM...201-1050
HUD-1

FOR: HUDSON ®

DF-F
0001-1975
HU-DF

FOR: HUF ®

DF-F
0001-1975
HU-DF.P

FOR: HUF ®

FOR: VOLKSWAGEN (CHINA) ®

AH...
1-8154
1001-9282
VO-AH

HV...
1-8154
1001-9282
VO-HV

VB-NV-MD...
1-8154
1001-9282
VO-VB

N...
VO-N

FOR: HUF ®
FOR: AKS ® -CASI ® -UBE ® -WITTE ®

AH...
1-8154
1001-9282
VO-AH.P

HV...
1-8154
1001-9282
VO-HV.P

VB-NV-MD...
1-8154
1001-9282
VO-VB.P

N...
VO-N.P

FOR: HUF ®
FOR: AKS ® -CASI ® -UBE ® -WITTE ®

AN...
001-854
1001-1918
2001-2830
3001-3890
4001-5151
6001-7086
7001-8154
8201-9282
AU-AN

FOR: HUF ®
FOR: AKS ® -CASI ® -UBE ® -WITTE ®

AN...
001-854
1001-1918
2001-2830
3001-3890
4001-5151
6001-7086
7001-8154
8201-9282
AU-AN.P

FOR: HUF ®
FOR: AKS ® -CASI ® -UBE ® -WITTE ®

FOR: VOLKSWAGEN (MEXICO) ®

SR
001-240
KSR
001-240
LSR
001-240
TSR
001-240
HU-SR

SE
001-750
SC
401-630
HU-SC

SU
001-240
401-630
HU-SU

SX
001-240
HU-SX

SZ
1-240
HU-SZ

SY
001-240
HU-SY

..M...
11-72.1-110
VO-M

..M...
11-72.1-110
VO-M.P

..R...
11-72.1-110
VO-R

FOR: HUF ®
FOR: AKS ® -CASI ® -WITTE ®

..M...
11-72.1-110
VO-M.P

..R...
11-72.1-110
VO-R.P

FOR: HUF ®
FOR: AKS ® -CASI ® -WITTE ®

KA
001-100
AKS-1

FOR: AKS ®

FOR: VOLVO ®

AS-11

AS-1D

7...
6...
1001-3300
AS-24

FOR: ASSA ®

JC
001-852
CEM-JC

AK
0001-1000
FO-5

FOR: CEM ®

A...201-1050
C...500-699
H...601-1100
HM...201-1050
HUD-1

FOR: HUDSON ®

DF-F
0001-1975
HU-DF

FOR: HUF ®

DF-F
0001-1975
HU-DF.P

FOR: HUF ®

FOR: VOLVO ®

DN-DH
6001-8000
HU-DH.P
FOR: HUF ®

DN-DH
6001-8000
HU-DN.P
FOR: HUF ®

FOR:
ASTON MARTIN ®
JAGUAR ®
LAND ROVER
MG ®
ROVER ®
VOLVO ®

FP
626-750
IN-1

FS
01-99
876-955
IN-4

FR
751-875
UN-4

FOR: UNION ®

...6250-6499
NE-9
FOR: NEIMAN ®

...6250-6499
NE-9.P
FOR: NEIMAN ®

Concerning the marks and commercial denominations see legal warning.
Conceniende a las marcas y denominaciones comerciales ver aviso legal.
Marka eta izendapen komertzialiei dagokienez, ikus lege-oharra.
Concernant les marques et denominations commerciales voir la note dans l'index.

JMA Opening the future

JMA Opening the future

Beziehen auf die Marke und Handelsname sehen sie die Notiz im Impressum.
Relativamente às marcas e denominações comerciais, ver aviso legal.
Jeśli chodzi o znaki i nazwy handlowe, patrz Informacje prawne.

FOR: VOLVO®

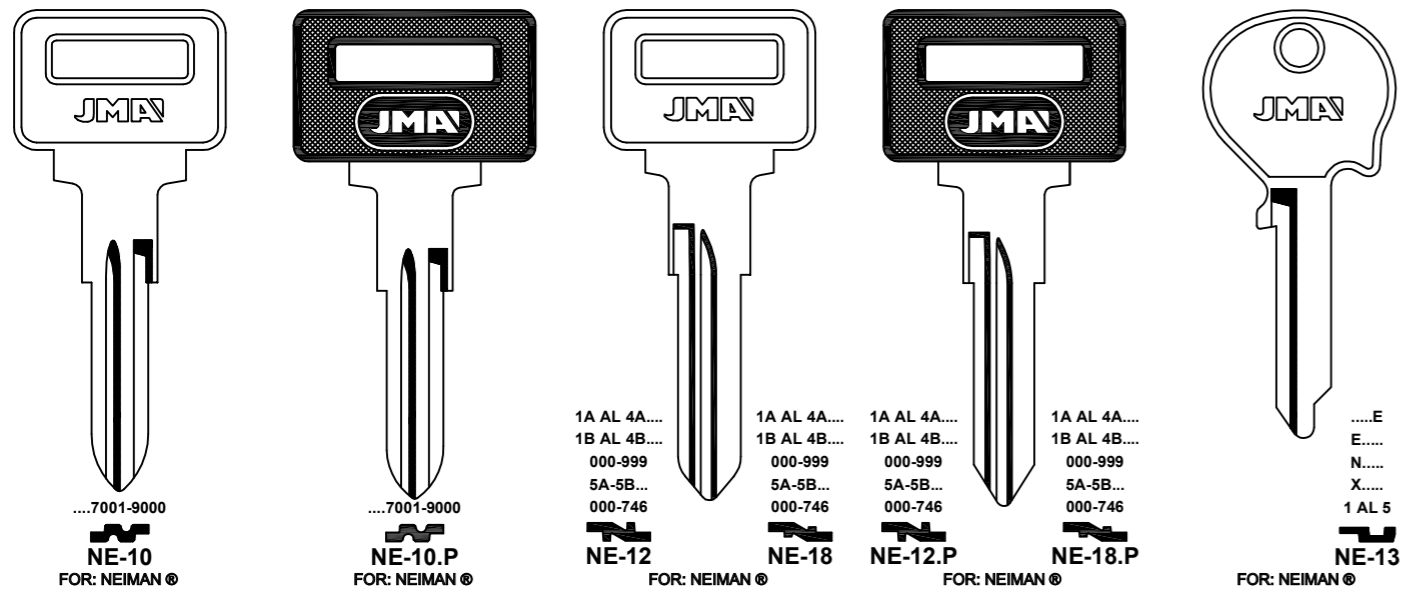

FOR: VOLVO®

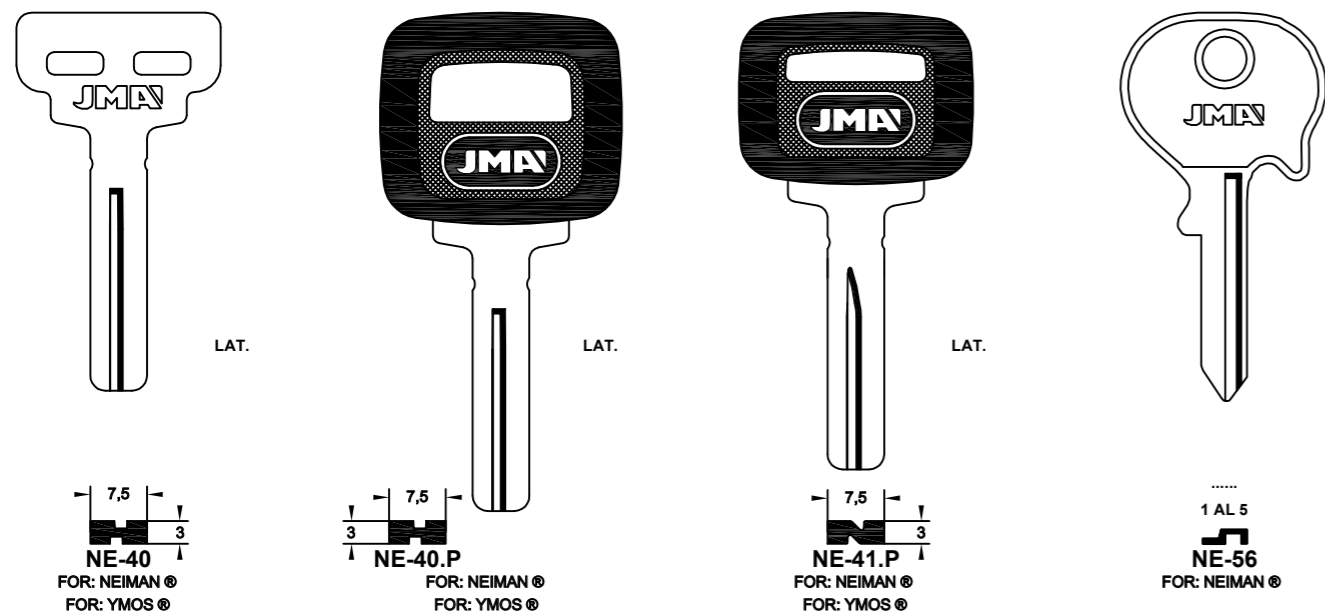

FOR: VOLVO®

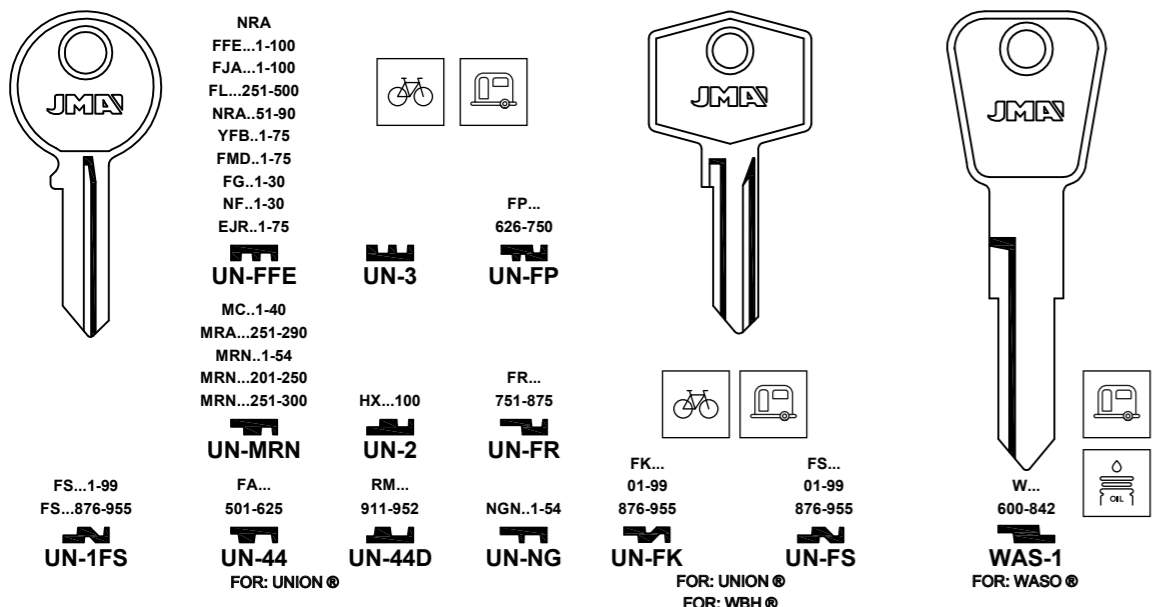

FOR: WARTBURG®

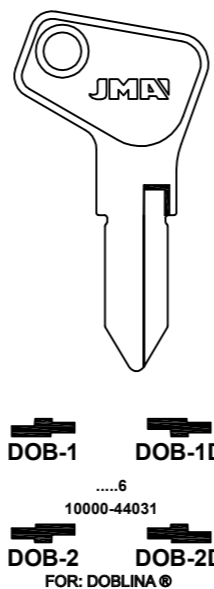

FOR: WARTBURG®

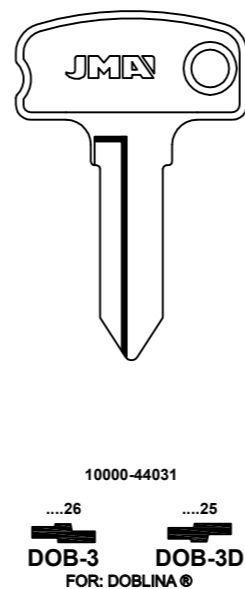

FOR: YAMAHA®

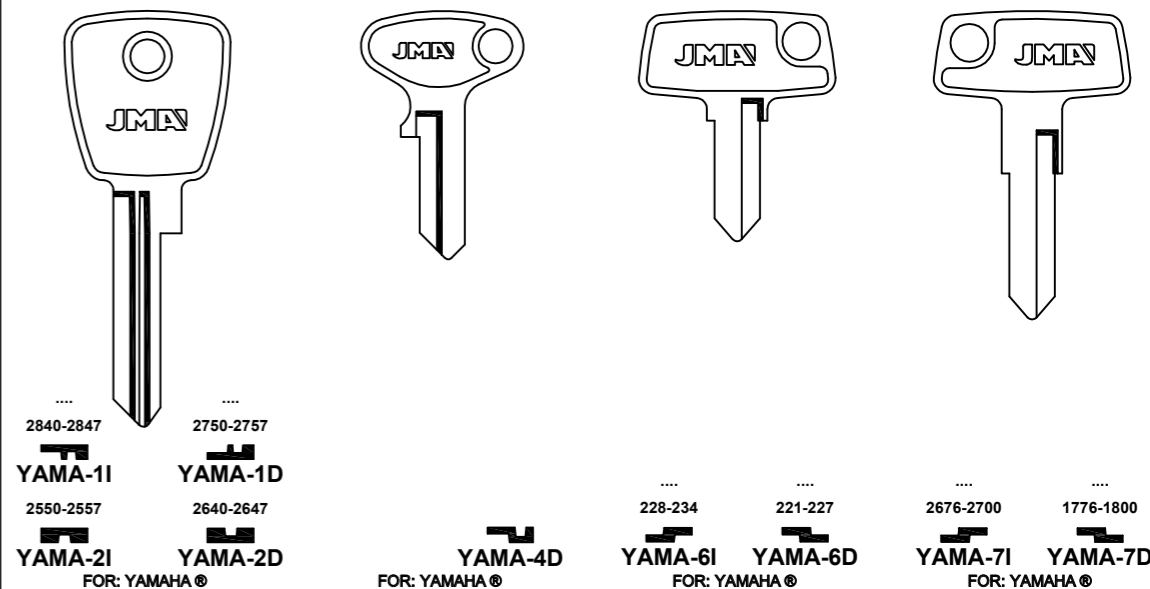

FOR: YAMAHA®

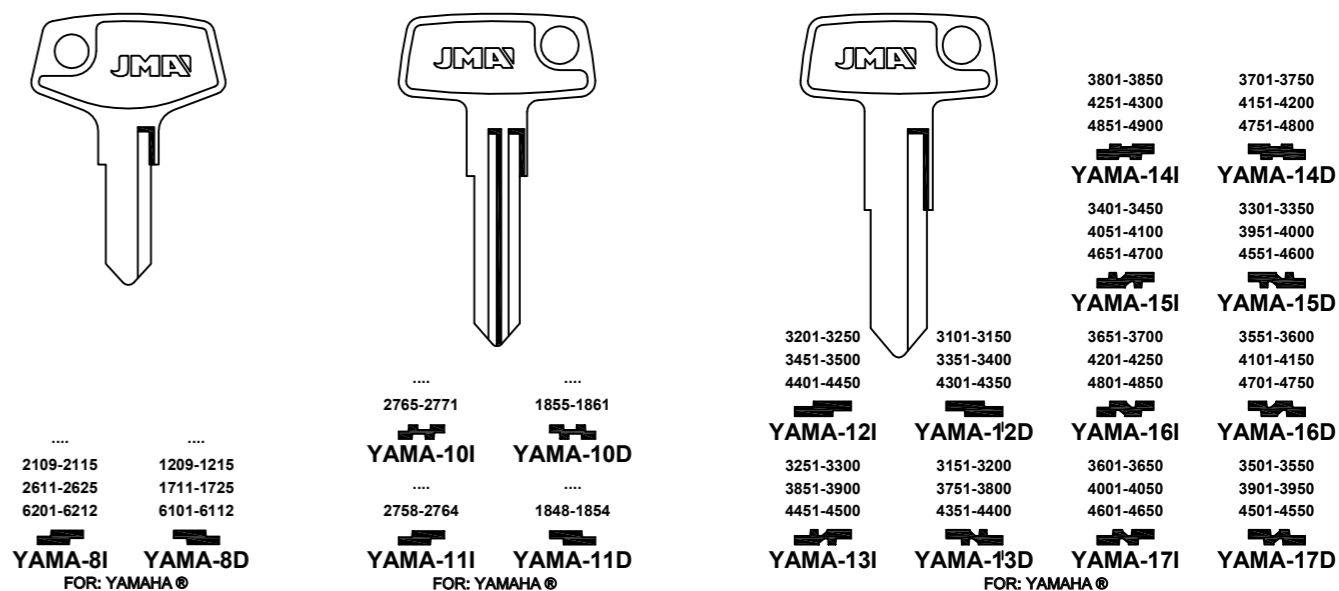

FOR: YAMAHA®

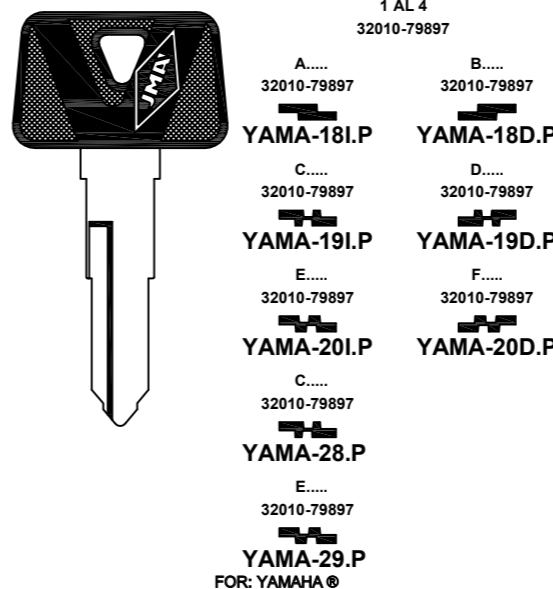

FOR: YUGO-ZASTAVA®

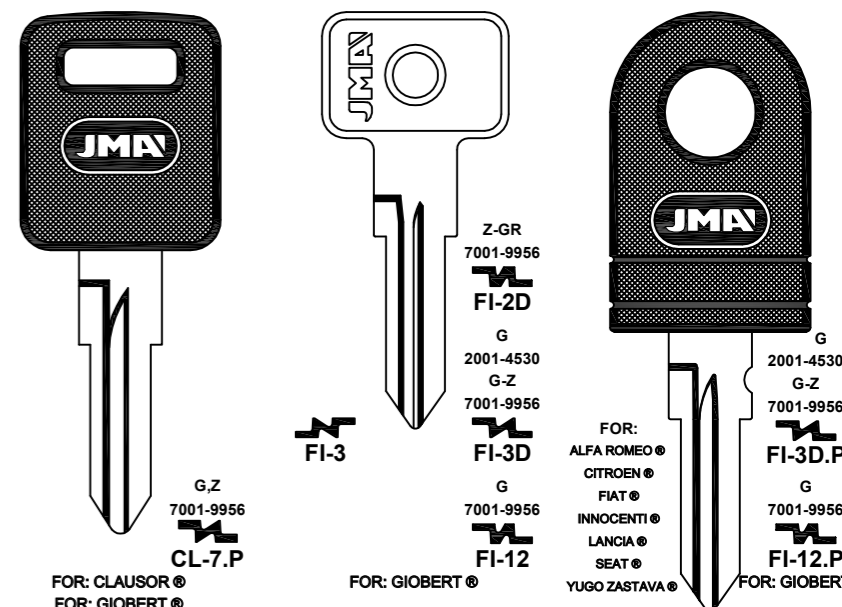

Concerning the marks and commercial denominations see legal warning.
 Concerniente a las marcas y denominaciones comerciales ver aviso legal.
 Marka eta izendapen komertzialiei dagokienez, ikus lege-oharra.
 Concernant les marques et denominations commerciales voir la note dans l'index.

JMA Opening the future

JMA Opening the future

Beziehen auf die marke und handelsname sehen sie die notiz im Impressum.
 Relativamente às marcas e denominações comerciais, ver aviso legal.
 Ješli chodzí o znaki i nazwy handlowe, patrz Informacje prawne.

FOR: ASTRA®

0501-3278
0,4,6,8,9

A
AF-7I

H
01-78
AF-8I

F
01-78
AF-9I

FOR: SIPEA®
FOR: SAFE®

0501-3278
0,4,6,8,9

A
AF-7D

G
01-78
AF-8D

E
01-78
AF-9D

FOR: SIPEA®
FOR: SAFE®

0501-1000
3

IMS-3

1
0501-1000
IMS-5

IMS-13

0501-1000
4

AF-21

2
0501-1000
AF-19

AF-19.P

IMS-3.P

IMS-5.P

IMS-13.P

FOR: SAFE®
FOR: CROMODORA® -FIST® -JMSA®
FOR: SAFE®
FOR: CROMODORA® -FIST® -JMSA®

FOR: BEDFORD®

FV-VM
101-225
301-360
VT...
400-474

LF-6

FOR: L. & F.®

FOR: BEDFORD®

W...600-842

WAS-5

M...100-174

WAS-6

FOR: WASO®

FOR: BROCKWAY®

USA GB ALU.

FOR: ABUS®
FOR: BENDIX®
FOR: CAB®
FOR: CHICAGO®
FOR: COLE HERSEE®

GC...
101-150
HC...
0-499

BS-4D

A...250-1500
AP...250-1500
B...250-1500
C...1251-1700
CB...250-1500
DC-EP...250-699
P...250-1500

DC...551-952

YA-8I

YA-8D

A...201-1050
C...500-699
H...601-1100
HM...201-1050

HUD-1

HUD-1D

FOR: HUDSON®

YA-9I

FOR: YALE®

YA-11I

YA-11D

FOR: YALE®

FOR: BEDFORD®

15001-19000
85001-87000

LF-9

FOR: L. & F.®
FOR: BRITAX®

FOR: AUSTRIN®
FOR: CARBODIES®
FOR: INNOCENTI®
FOR: LAND ROVER®
FOR: LOTUS®
FOR: MASERATI®
FOR: OM IVECO®
FOR: ROVER®
FOR: VAUXHALL®
FOR: BEDFORD®
FOR: FIAT IVECO®

RO
BL...N
1001-2000

LF-RO

FOR: L. & F.®

...2001-4949
GM
1001-3000

NE-1

FOR: NEIMAN®
FOR: CLAUSSOR®

...2001-4949
GM
1001-3000

NE-1D

FOR: NEIMAN®
FOR: CLAUSSOR®

...2001-4949
GM
1001-3000

NE-1.P

FOR: NEIMAN®
FOR: CLAUSSOR®

...2001-4949
GM
1001-3000

NE-1D.P

FOR: NEIMAN®
FOR: CLAUSSOR®

FOR: DAF®

.....A/Z
B-C-D-E
1/9...A/Z
1/9...A/Z
.....A/Z
B-D-E-G-H-J
.1/9...A/Z
.1/9...A/Z
E-M-N-P-R

CHR-3

FOR: CHRYSLER®
FOR: CLAUSSOR® -NEIMAN®

FOR: A. MOTORS
FOR: CITROEN®
FOR: MAZDA®
FOR: PEUGEOT®
FOR: RENAULT®
FOR: TALBOT®
FOR: DAF®
FOR: NISSAN®
FOR: PEGASO®

.....A/Z
B-C-D-E
1/9...A/Z
1/9...A/Z
.....A/Z
B-D-E-G-H-J
.1/9...A/Z
.1/9...A/Z
E-M-N-P-R

CHR-3.P

FOR: CHRYSLER®
FOR: CLAUSSOR® -NEIMAN®

6,1 | 1,95

DAV-1

FOR: DAV®

6,1 | 1,95

DAV-1.P

FOR: DAV®

FOR: BEDFORD®

...7001-9000

NE-10

FOR: NEIMAN®

...7001-9000

NE-10.P

FOR: NEIMAN®

FS...1-99
FS...876-955

UN-1FS

NRA
FFE...1-100
FJA...1-100
FL...251-500
NRA...51-90
YFB...1-75
FMD...1-75
FG...1-30
NF...1-30
EJR...1-75

UN-FFE

MC...1-40
MRA...251-290
MRN...1-54
MRN...201-250
MRN...251-300

UN-MRN

FA...
501-625

UN-44

FOR: UNION®

HX...100

UN-2

FR...
751-875

UN-FR

FT-BC...301-360
BC-FT...101-225
LF...451-575
CB...801-875

UN-FT

TF...1001-1140

UN-TF

FOR: UNION®
FOR: CEM®

FP...
626-750

UN-FP

FP...
626-750

UN-FP

FOR: DAF®

DA-OA
001-210
ER-PN
101-295
ER
001-195
ER
501-695

FO-OA

FOR: FORD®
FOR: CASI® -HUF® -YMOS®

OL
001-210
07R
001-195
7OR
001-210

FO-OL

FOR: FORD®
FOR: CASI® -YMOS®

07L
001-195
7OL
001-210
OR
001-210

FO-OR

R
001-224

LAS-R

FOR: LAS®
FOR: DUBOIS® -KIFERM® -PJ® -PK®

V
001-224

LAS-V

FOR: LAS®
FOR: DUBOIS® -KIFERM® -PJ® -PK®

Y
001-224

LAS-Y

FOR: LAS®
FOR: DUBOIS® -KIFERM® -PJ® -PK®

.....A/Z
A/Z...
A/Z...A/Z
1 AL 7
.....A/Z
0 AL 9

NE-3

FOR: NEIMAN®
FOR: CLAUSSOR®

.....A/Z
A/Z...
A/Z...A/Z
1 AL 7
.....A/Z
0 AL 9

NE-3D

FOR: NEIMAN®
FOR: CLAUSSOR®

.....A/Z
A/Z...
A/Z...A/Z
1 AL 7
.....A/Z
0 AL 9

NE-3.P

FOR: NEIMAN®
FOR: CLAUSSOR®

FOR: EBRO®
FOR: FIAT®
FOR: LADA VAZ®
FOR: MOSKVITCH®
FOR: PEUGEOT®
FOR: RENAULT®
FOR: TALBOT SIMCA®
FOR: ZAZ®
FOR: DAF®
FOR: VOLVO®

FOR: EBRO®
FOR: FIAT®
FOR: LADA VAZ®
FOR: MOSKVITCH®
FOR: PEUGEOT®
FOR: RENAULT®
FOR: TALBOT SIMCA®
FOR: ZAZ®
FOR: DAF®
FOR: VOLVO®

Concerning the marks and commercial denominations see legal warning.
Concerniente a las marcas y denominaciones comerciales ver aviso legal.
Marka eta izendapen komertzialiei dagokienez, ikus lege-oharra.
Concernant les marques et denominations commerciales voir la note dans l'index.

Beziehen auf die marke und handelsname sehen sie die notiz im Impressum.
Relativamente às marcas e denominações comerciais, ver aviso legal.
Jeśli chodzi o znaki i nazwy handlowe, patrz Informacje prawne.

FOR: DAF®

.....A/Z
A/Z.....
A/Z.....A/Z
1 AL 7
.....A/Z
0 AL 9

EBRO®
FIAT®
LADA VAZ®
MOSKVITCH®
PEUGEOT®
RENAULT®
TALBOT SIMCA®
ZAZ®
VOLVO®

NE-3.P1
FOR: NEIMAN®
FOR: CLAUSOR®

.....A/Z
A/Z.....
A/Z.....A/Z
1 AL 7
.....A/Z
0 AL 9

EBRO®
FIAT®
LADA VAZ®
MOSKVITCH®
PEUGEOT®
RENAULT®
TALBOT SIMCA®
ZAZ®
VOLVO®

NE-3.P2
FOR: NEIMAN®
FOR: CLAUSOR®

NSP....
4000-4999
7001-9000
E.....
2001-3000
4001-5000
S.....
2001-3000

NE-11
FOR: NEIMAN®
FOR: DAF®-KENWORTH®

NSP....
4000-4999
7001-9000
E.....
2001-3000
4001-5000
S.....
2001-3000

NE-11.P
FOR: NEIMAN®
FOR: DAF®-KENWORTH®

.....A/Z
B-C-D-E
1/9.....A/Z
1/9.....A/Z
.....A/Z
B-D-E-G-H-J
.1/9.....A/Z
.1/9.....A/Z
E-M-N-P-R

A.MOTORS
RENAULT®
DAF®
NISSAN®

NE-22.P
FOR: NEIMAN®
FOR: CLAUSOR®

FOR: DAF®

.....
.....A/Z
B-C-D-E
1/9.....A/Z
1/9.....A/Z
.....A/Z
B-D-E-G-H-J
.1/9.....A/Z
.1/9.....A/Z
E-M-N-P-R

NE-22.P2
FOR: NEIMAN®
FOR: CLAUSOR®

.....
.....A/Z
B-C-D-E
1/9.....A/Z
1/9.....A/Z
.....A/Z
B-D-E-G-H-J
.1/9.....A/Z
.1/9.....A/Z
E-M-N-P-R

RO-2I
FOR: RONIS®
FOR: ABSA®-FROSER®-PJ®-SADV®

.....
.....A/Z
B-C-D-E
1/9.....A/Z
1/9.....A/Z
.....A/Z
B-D-E-G-H-J
.1/9.....A/Z
.1/9.....A/Z
E-M-N-P-R

RO-1I
FOR: RONIS®
FOR: ABSA®-FROSER®-PJ®-SADV®

.....
.....A/Z
B-C-D-E
1/9.....A/Z
1/9.....A/Z
.....A/Z
B-D-E-G-H-J
.1/9.....A/Z
.1/9.....A/Z
E-M-N-P-R

RO-1D
FOR: RONIS®
FOR: ABSA®-FROSER®-PJ®-SADV®

.....
.....A/Z
B-C-D-E
1/9.....A/Z
1/9.....A/Z
.....A/Z
B-D-E-G-H-J
.1/9.....A/Z
.1/9.....A/Z
E-M-N-P-R

RO-6I
FOR: RONIS®
FOR: ABSA®-FROSER®-PJ®-SADV®

.....
.....A/Z
B-C-D-E
1/9.....A/Z
1/9.....A/Z
.....A/Z
B-D-E-G-H-J
.1/9.....A/Z
.1/9.....A/Z
E-M-N-P-R

RO-6D
FOR: RONIS®
FOR: ABSA®-FROSER®-PJ®-SADV®

AH....
1-8154
1001-9282

VO-AH
FOR: HUF®

HV....
1-8154
1001-9282

VO-HV
FOR: HUF®

VB-NV-MD....
1-8154
1001-9282

VO-VB
FOR: HUF®

N....
FOR: HUF®

AN....
001-854
1001-1918
2001-2830
3001-3890
4001-5151
6001-7086
7001-8154
8201-9282

AU-AN
FOR: HUF®

FOR: DAF®

AH....
1-8154
1001-9282

VO-AH.P
FOR: HUF®

HV....
1-8154
1001-9282

VO-HV.P
FOR: AKS®-CASI®-UBE®-WITTE®

VB-NV-MD....
1-8154
1001-9282

VO-VB.P
FOR: HUF®

N....
FOR: HUF®

VO-N.P
FOR: HUF®

AN....
001-854
1001-1918
2001-2830
3001-3890
4001-5151
6001-7086
7001-8154
8201-9282

AU-AN.P
FOR: HUF®

X....1-4088
WAS-3
FOR: WASO®

D....1-4088
X....1-4088

WAS-4
FOR: WASO®

W...600-842
WAS-5
FOR: WASO®

M...100-174
WAS-6
FOR: WASO®

FOR: DIAMOND R.®

A....201-1050
C...500-699
H...601-1100
HM...201-1050

HUD-1
FOR: HUDSON®

HUD-1D
FOR: HUDSON®

FOR: FIAT IVECO®

FOR:
CROMODORA®
FIST®
FREA®
GIOBERT®
MIRAGLIO®
RUFFINI®

A
0501-3278
0,4,6,8,9

AF-7I
FOR: SAFE®

A
0501-3278
0,4,6,8,9

AF-7D
FOR: SAFE®

A
0501-3278
0,4,6,8,9

AF-7I.P
FOR: SIPEA®
FOR: SAFE®

6
100-309
AF-5I
FOR: SAFE®

8
100-309
AF-5D
FOR: SAFE®

H
O1-78
AF-8I
FOR: SIPEA®
FOR: SAFE®

G
O1-78
AF-8D
FOR: SIPEA®
FOR: SAFE®

H
O1-78
AF-8I.P
FOR: SIPEA®
FOR: SAFE®

G
O1-78
AF-8D.P
FOR: SIPEA®
FOR: SAFE®

F
O1-78
AF-9I.P
FOR: SIPEA®
FOR: SAFE®

E
O1-78
AF-9D.P
FOR: SIPEA®
FOR: SAFE®

K-H
7001-8092
AF-14.P
FOR: GIOBERT®
FOR: FIAT®-M.MARELLI®-NEIMAN®-SIPEA®

K.3301-4886
K.7001-8092
T.5000-6027
T.7001-8092
S.0501-3278
H.7001-8092

FI-6I.P4
FOR: GIOBERT®
FOR: FIAT®-M.MARELLI®-NEIMAN®-SIPEA®

FOR:
AKS®
CASI®
NEIMAN®
UBE®
WITTE®
YMOS®

HV....
1-854
1001-9282

AU-1
FOR: HUF®
FOR: VOLKSWAGEN®-SCANIA®

FOR: FIAT IVECO®

FOR:
AKS®
CASI®
NEIMAN®
UBE®
WITTE®
YMOS®

HV....
1-854
1001-9282

AU-HV
FOR: HUF®

FOR:
AKS®
CASI®
NEIMAN®
UBE®
WITTE®
YMOS®

HV....
1-854
1001-9282

AU-HV.P
FOR: HUF®

BH-2
FOR: BOSCH®

A...
101-125
501-598
701-790

BL-2
FOR: BLAU®
FOR: FORT®-HK®-WASO®

B...
201-225

BL-3
FOR: BLAU®
FOR: FORT®-HK®-WASO®

A
BL-4
FOR: BLAU®
FOR: FORT®-HK®-WASO®

B
BL-4D
FOR: BLAU®
FOR: FORT®-HK®-WASO®

U/V/Y...U
1 AL 7
CT-1
FOR: SIMPLEX®
FOR: NEIMAN®-VACHETTE®

FOR: FIAT IVECO®

U/V/Y...U
1 AL 7
CT-1.P
FOR: SIMPLEX®
FOR: NEIMAN®-VACHETTE®

B-T...T
1 AL 7
CT-3
FOR: SIMPLEX®
FOR: NEIMAN®-VACHETTE®

B-T...T
1 AL 7
CT-3.P
FOR: SIMPLEX®
FOR: NEIMAN®-VACHETTE®

F
01-78
FEM-1I
FOR: FEMSA®

E
01-78
FEM-1D
FOR: FEMSA®

H
01-78
FEM-2I
FOR: FEMSA®

G
01-78
FEM-2D
FOR: FEMSA®

F
01-78
FEM-3I
FOR: FEMSA®

E
01-78
FEM-3D
FOR: FEMSA®

J
3001-6732
N
6001-7000
FI-1.P
FOR: GIOBERT®
FOR: RAYTON FISSORE®-STREYR PUCH®
FOR: CAGIVA®-GILERA®-PIAGGIO VESPA®

Concerning the marks and commercial denominations see legal warning.
Concerniente a las marcas y denominaciones comerciales ver aviso legal.
Marka eta izendapen komertzialiei dagokienez, ikus lege-oharra.
Concernant les marques et denominations commerciales voir la note dans l'index.



Beziehen auf die Marke und Handelsname sehen sie die Notiz im Impressum.
Relativamente às marcas e denominações comerciais, ver aviso legal.
Jeśli chodzi o znaki i nazwy handlowe, patrz Informacje prawne.

FOR: FIAT IVECO®

FI-3
 Z-GR
 7001-9956
 G
 2001-4530
 G-Z
 7001-9956
 FOR: GIOBERT®
 FOR: YUGO ZASTAVA® -FIAT IVECO®

FI-2D
 Z-GR
 7001-9956
 G
 2001-4530
 G-Z
 7001-9956
 FOR: GIOBERT®

FI-2D.P3
 Z-GR
 7001-9956
 G
 2001-4530
 G-Z
 7001-9956
 FOR: GIOBERT®

FI-3D
 G
 2001-4530
 G-Z
 7001-9956
 FOR: GIOBERT®

FI-3D.P1
 G
 2001-4530
 G-Z
 7001-9956
 FOR: GIOBERT®

FI-3D.P4
 G
 2001-4530
 G-Z
 7001-9956
 FOR: GIOBERT®

FI-3D.P5
 G
 2001-4530
 G-Z
 7001-9956
 FOR: GIOBERT®

FI-12
 G
 7001-9956
 FOR: GIOBERT®

FI-12.P3
 G
 7001-9956
 FOR: GIOBERT®

FI-12.P1
 G
 7001-9956
 FOR: GIOBERT®

FOR: FIAT IVECO®

FI-4D
 FOR: GIOBERT®
 FOR: IACAM®

FI-5I
 FOR: GIOBERT®

FI-5D
 FOR: GIOBERT®

FI-6I
 FOR: GIOBERT®

FI-6I.P
 FOR: GIOBERT®

FI-6I.P1
 FOR: GIOBERT®

FI-6I.P2
 FOR: GIOBERT®

FOR:
 ALFA ROMEO®
 AUTOBIANCHI®
 CITROEN®
 FERRARI®
 FIAT®
 INNOCENTI®
 LANCIA®
 PEUGEOT®
 YUGO ZASTAVA®
 CAGIVA®
 DUCATI®
 FANTIC MOTOR®
 GARELLI®
 GILERA®

K 3301-4886
 K 7001-8092
 T 5000-6027
 T 7001-8092
 S 0501-3278
 H 7001-8092

K 3301-4886
 K 7001-8092
 T 5000-6027
 T 7001-8092
 S 0501-3278
 H 7001-8092

K 3301-4886
 K 7001-8092
 T 5000-6027
 T 7001-8092
 S 0501-3278
 H 7001-8092

FOR:
 FERRARI®
 FIAT®
 INNOCENTI®
 LANCIA®

FOR:
 FERRARI®
 FIAT®
 CAGIVA®

FOR: FIAT IVECO®

FI-9I
 FOR: GIOBERT®

FI-9I.P
 FOR: GIOBERT®

FI-11
 FOR: GIOBERT®

FI-11.P
 FOR: GIOBERT®

FIS-1D
 FOR: FIST®

N 6001-7000
 J 3001-6732
 V 0001-3051
 V 5001-8058
 AB 6001-6891

N 6001-7000
 J 3001-6732
 V 0001-3051
 V 5001-8058
 AB 6001-6891

FOR: FIAT IVECO®

IMS-3
 FOR: SAFE®
 FOR: CROMODORA® -FIST® -IMSA®

AF-21
 FOR: SAFE®
 FOR: CROMODORA® -FIST® -IMSA®

IMS-3.P
 FOR: SAFE®
 FOR: CROMODORA® -FIST® -IMSA®

AF-21.P
 FOR: SAFE®
 FOR: CROMODORA® -FIST® -IMSA®

IMS-5
 FOR: L. & F.®

AF-19
 FOR: L. & F.®

IMS-5.P
 FOR: L. & F.®

AF-19.P
 FOR: L. & F.®

IMS-13
 FOR: L. & F.®

IMS-13.P
 FOR: L. & F.®

LF-RO
 FOR: L. & F.®

NE-1
 FOR: NEIMAN®
 FOR: CLAUSOR®

NE-1D
 FOR: NEIMAN®
 FOR: CLAUSOR®

FOR:
 AUSTIN®
 CARBODIES®
 INNOCENTI®
 LAND ROVER®
 LOTUS®
 MASERATI®
 OM IVECO®
 ROVER®
 VAUXHALL®
 BEDFORD®
 FIAT IVECO®

FOR:
 AUSTIN®
 CARBODIES®
 INNOCENTI®
 LAND ROVER®
 LOTUS®
 MASERATI®
 OM IVECO®
 ROVER®
 VAUXHALL®
 BEDFORD®
 FIAT IVECO®

RO
 BL...N
 1001-2000

RO
 BL...N
 1001-2000

...2001-4949
 GM
 ...2001-3000

FOR:
 AUDI®
 HONDA®
 MG®
 ROVER®
 BEDFORD®
 FIAT IVECO®
 VOLVO®

...124-197
 ...501-598
 ...701-790
 ...G06-G10
 ...0G1-1G0
 A...101-125
 A...701-790
 G...001-100

FOR: FIAT IVECO®

NE-1.P
 FOR: NEIMAN®
 FOR: CLAUSOR®

NE-1D.P
 FOR: NEIMAN®
 FOR: CLAUSOR®

PRE-3
 FOR: PRESTA®
 FOR: LAPORTE®

PRE-11
 FOR: PRESTA®
 FOR: LAPORTE®

SIP-1
 FOR: SIPEA®

VO-1
 FOR: HUF®
 FOR: NEIMAN®

...2001-4949
 GM®
 ...2001-3000

...124-197
 ...501-598
 ...701-790
 ...G06-G10
 ...0G1-1G0
 A...101-125
 A...701-790
 G...001-100

FOR: FIAT IVECO®

VO-AH
 FOR: HUF®
 FOR: AKS® -CASI® -UBE® -WITTE®

VO-AH.P
 FOR: HUF®
 FOR: AKS® -CASI® -UBE® -WITTE®

VO-HV
 FOR: HUF®
 FOR: AKS® -CASI® -UBE® -WITTE®

VO-HV.P
 FOR: HUF®
 FOR: AKS® -CASI® -UBE® -WITTE®

VO-VB
 FOR: HUF®
 FOR: AKS® -CASI® -UBE® -WITTE®

VO-VB.P
 FOR: HUF®
 FOR: AKS® -CASI® -UBE® -WITTE®

VO-N
 FOR: HUF®
 FOR: AKS® -CASI® -UBE® -WITTE®

VO-N.P
 FOR: HUF®
 FOR: AKS® -CASI® -UBE® -WITTE®

AU-AN
 FOR: HUF®
 FOR: AKS® -CASI® -UBE® -WITTE®

AU-AN.P
 FOR: HUF®
 FOR: AKS® -CASI® -UBE® -WITTE®

AH...
 1-8154
 1001-9282

AH...
 1-8154
 1001-9282

HV...
 1-8154
 1001-9282

HV...
 1-8154
 1001-9282

VB-NV-MD...
 1-8154
 1001-9282

VB-NV-MD...
 1-8154
 1001-9282

N...
 001-854
 1001-1918
 2001-2830
 3001-3890
 4001-5151
 6001-7086
 7001-8154
 8201-9282

N...
 001-854
 1001-1918
 2001-2830
 3001-3890
 4001-5151
 6001-7086
 7001-8154
 8201-9282

FOR: FORD®

FO-E/TC
 FOR: FORD®
 FOR: CASI® -CEM® -CLAUSOR®
 FOR: KOLB® -NEIMAN®

AK
 0001-1000
 TC
 0001-1000
 TX
 0001-1859

Concerning the marks and commercial denominations see legal warning.
 Concerniente a las marcas y denominaciones comerciales ver aviso legal.
 Marka eta izendapen komertzialiei dagokienez, ikus lege-oharra.
 Concernant les marques et denominations commerciales voir la note dans l'index.

FOR: FORD®

AK 0001-1000 TC 0001-1000 TX 0001-1859 FO-E/TX.P FOR: FORD®	AK 0001-1000 TC 0001-1000 TX 0001-1859 FO-TX FOR: FORD®	AK 0001-1000 TC 0001-1000 TX 0001-1859 FO-TX.P FOR: FORD®	R 001-224 LAS-R V 001-224 LAS-V Y 001-224 LAS-Y FOR: LAS®	FV-VM 101-225 301-360 VT... 400-474 LF-6 FOR: L. & F.®

FOR: CASI®-CEM®-CLAUSOR®-KOLB®-NEIMAN® FOR: CASI®-CEM®-CLAUSOR®-KOLB®-NEIMAN® FOR: CASI®-CEM®-CLAUSOR®-KOLB®-NEIMAN® FOR: CASI®-CEM®-CLAUSOR®-KOLB®-NEIMAN® FOR: CASI®-CEM®-CLAUSOR®-KOLB®-NEIMAN® FOR: CASI®-CEM®-CLAUSOR®-KOLB®-NEIMAN® FOR: CASI®-CEM®-CLAUSOR®-KOLB®-NEIMAN® FOR: CASI®-CEM®-CLAUSOR®-KOLB®-NEIMAN® FOR: CASI®-CEM®-CLAUSOR®-KOLB®-NEIMAN® FOR: CASI®-CEM®-CLAUSOR®-KOLB®-NEIMAN® FOR: CASI®-CEM®-CLAUSOR®-KOLB®-NEIMAN® FOR: CASI®-CEM®-CLAUSOR®-KOLB®-NEIMAN® FOR: CASI®-CEM®-CLAUSOR®-KOLB®-NEIMAN®

FOR: FORD (USA)®

A 101-291 501-579 B 101-332 501-602 C 101-344 501-624 D 101-327 501-602 E 101-296 501-579 FA 6500-7733 FO-20D FOR: FORD®	WR 3000-3999 5000-5999 LF-WR FOR: L. & F.® FOR: WILMOT BREEDEN®	MAZ-1I 2000-2499 MAZ-1D 1500-1999 5000-6100 FOR: MAZDA®	MAZ-14D ...002-989 FOR: MAZDA®	NE-11 NSP... 4000-4999 7001-9000 E... 2001-3000 4001-5000 S... 2001-3000 FOR: NEIMAN®

FOR: FORD®

S 101-295 401-465 501-695 ME-S FOR: HUF® FOR: CASI®	S 101-295 401-465 501-695 ME-S.P FOR: HUF® FOR: CASI®	NSP... 4000-4999 7001-9000 E... 2001-3000 4001-5000 S... 2001-3000 NE-11.P3 FOR: NEIMAN®	NRA FFE...1-100 FJA...1-100 FL...251-500 NRA...51-90 YFB...1-75 FMD...1-75 FG...1-30 NF...1-30 EJR...1-75 UN-FFE MC...1-40 MRA...251-290 MRN...1-54 MRN...201-250 MRN...251-300 UN-MRN FA... 501-625 UN-44 FOR: UNION®	FP... 626-750 UN-FP FR... 751-875 UN-FR HX...100 UN-2 RM... 911-952 UN-44D NGN...1-54 UN-NG FOR: L. & F.® FOR: WILMOT BREEDEN®

FOR: FORD (USA)®

NSP... 4000-4999 7001-9000 E... 2001-3000 4001-5000 S... 2001-3000 NE-11.P FOR: NEIMAN®	NSP... 4000-4999 7001-9000 E... 2001-3000 4001-5000 S... 2001-3000 NE-11.P3 FOR: NEIMAN®	FT-BC...301-360 BC-FT...101-225 LF...451-575 CB...801-875 UN-FT FOR: UNION®

FOR: FREIGHTLIN®

LAT. A...250-1500 AP...250-1500 B...250-1500 C...1251-1700 CB...250-1500 DC-EP...250-699 P...250-1500 AMM-1 FOR: AMERICAN MOT.®	LAT. GC... 101-150 HC... 0-499 BS-4D FOR: B & S®

FOR: FORD®

FK... 01-99 876-955 UN-FK FOR: UNION® FOR: WBH®	FS... 01-99 876-955 UN-FS FOR: UNION® FOR: CEM®

FOR: FORD (USA)®

A 101-291 501-579 B 101-332 501-602 C 101-344 501-624 D 101-327 501-602 E 101-296 501-579 FA 6500-7733 FO-11D FOR: FORD®	...X 0001-1706 FO-15D FOR: FORD®	...X 0001-1706 FO-15D.P FOR: FORD®

FOR: FREIGHTLIN®

A...201-1050 C...500-699 H...601-1100 HM...201-1050 HUD-1 FOR: HUDSON®	GB YA-8I YA-8D YA-9I FOR: YALE®	FOR: ABUS® BENDIX® CAB® CHICAGO® COLE HERSEE® HELIX® FORT® USA GB DC...551-952 YA-27 YA-27D FOR: YALE®

FOR: GM (CHEVROLET)®

H 001-400 2221-2620 4441-4640 4641-5143 E 2001-3000 MIT-1I FOR: MITSUBISHI®	H 001-400 2221-2620 4441-4640 4641-5143 E 2001-3000 MIT-1D MIT-1I.P MIT-1D.P FOR: MITSUBISHI®

Concerning the marks and commercial denominations see legal warning.
 Concerniente a las marcas y denominaciones comerciales ver aviso legal.
 Marka eta izendapen komertzialei dagokienez, ikus lege-oharra.
 Concernant les marques et denominations commerciales voir la note dans l'index.



FOR: GM (CHEVROLET)®

H
001-400
2221-2620
4441-4640
4641-5143
E
2001-3000

H
001-400
2221-2620
4441-4640
4641-5143
E
2001-3000

A....
0001-0400
2221-2620
4441-4640
B....
5001-6000
C....
6001-7000
M....
5551-5950
6661-7060
7771-8170
8814-9280
N....
1921-2220

MIT-21
FOR: MITSUBISHI®

MIT-21.P
FOR: MITSUBISHI®

TOYO-2
FOR: TOYOTA®
FOR: TOKAJ® -RIKA®

FOR: GM (GMC)®

X
0001-8000
DAT-6
DAT-6D

Y
0001-8000
8001-9000
DAT-7
FOR: NISSAN®
FOR: DATSUN®

FOR: ISUZU®

X
0001-8000
DAT-6
DAT-6D

X
0001-8000
DAT-6.P1
DAT-6D.P1

Y
0001-8000
8001-9000
DAT-7
FOR: NISSAN®
FOR: DATSUN®

Y
0001-8000
8001-9000
DAT-7.P1
FOR: NISSAN®
FOR: DATSUN®

A....
8001-9400
ISU-1
FOR: ISUZU®

FOR: GM (GMC)®

X
0001-8000
DAT-6.P1
DAT-6D.P1

Y
0001-8000
8001-9000
DAT-7.P1
FOR: NISSAN®
FOR: DATSUN®

A....
8001-9400
ISU-2
FOR: ISUZU®

FOR: GMC®

U
1-2000
GM-5
FOR: BRIGGS S.®

U
1-2000
GM-5.P
FOR: BRIGGS S.®

FOR: ISUZU®

A....
8001-9400
ISU-2
FOR: ISUZU®

H
001-400
2221-2620
4441-4640
4641-5143
E
2001-3000
MIT-11
FOR: MITSUBISHI®

H
001-400
2221-2620
4441-4640
4641-5143
E
2001-3000
MIT-1D
FOR: MITSUBISHI®

H
001-400
2221-2620
4441-4640
4641-5143
E
2001-3000
MIT-11.P
FOR: MITSUBISHI®

E
5001-7000
MIT-1D.P
FOR: MITSUBISHI®

E
5001-7000
7001-7679
MIT-15.P
FOR: MITSUBISHI®

FOR: IVECO®

FOR:
AUTOBIANCHI®
CITROEN®
FERRARI®
FIAT®
LANCIA®
PEUGEOT®
YUGO ZASTAVA®
CAGIVA®
DUCATI®
FANTIC MOTOR®
GARELLI®
GILERA®

K 3301-4886
K 7001-8092
T 5000-6027
T 7001-8092
S 0501-3278
H 7001-8092
FI-6I.P3
FOR: GIOBERT®

FOR: HINO®

K....
001-400/1511-1910
2221-2620/3731-4570
5001-6368
R....
401-800/1112-1510
2621-3020/3331-3730
5001-6924/8001-9368
S....
5951-6350/7061-7460
8171-8570/9281-9680
D....
6001-7042
TOYO-K1
FOR: TOYOTA®
FOR: TOKAJ® -RIKA®

F....
5951-6350
7061-7460
8171-8570
9281-9680
P....
7001-8500
TOYO-4

K....
001-400/1511-1910
2221-2620/3731-4570
5001-6368
R....
401-800/1112-1510
2621-3020/3331-3730
5001-6924/8001-9368
S....
5951-6350/7061-7460
8171-8570/9281-9680
D....
6001-7042
TOYO-K1.P
FOR: TOYOTA®
FOR: TOKAJ® -RIKA®

F....
5951-6350
7061-7460
8171-8570
9281-9680
P....
7001-8500
TOYO-14.P

FOR: KENWORTH®

OL
001-210
07R
001-195
7OR
001-210
FO-OL
FOR: FORD®
FOR: CASI® -YMOŠ®

O7L
001-195
7OL
001-210
OR
001-210
FO-OR

NSP....
4000-4999
7001-9000
E....
2001-3000
4001-5000
S....
2001-3000
NE-11
FOR: NEIMAN®
FOR: DAF® -KENWORTH®

FOR: MACK®

NSP....
4000-4999
7001-9000
E....
2001-3000
4001-5000
S....
2001-3000
AMM-1
FOR: AMERICAN MOT.®

LAT.

Concerning the marks and commercial denominations see legal warning.
Concerniente a las marcas y denominaciones comerciales ver aviso legal.
Marka eta izendapen komertzialiei dagokienez, ikus lege-oharra.
Concernant les marques et denominations commerciales voir la note dans l'index.

FOR: MACK®

BAS-4
FOR: BASCO®
FOR: ELMO®-HERSEE E.®-ILLINOIS®-YALE®

BH-1
FOR: BOSCH®
FOR: NEIMAN®

BH-1.P
FOR: BOSCH®
FOR: NEIMAN®

BS-1I
FOR: B & S®
FOR: DEXTER®-POLLAK®-BOBCAT®

DAV-1
FOR: DAV®

FOR: MACK®

DAV-1.P
FOR: DAV®

MAK-1
FOR: MACK®

RO-1I
RO-1D
FOR: RONIS®
FOR: ABSA®-FROSER®-PJ®-SADV®

RO-2I
RO-2D
RO-4I
RO-4D
RO-6I
RO-6D
FOR: RONIS®
FOR: ABSA®-FROSER®-PJ®-SADV®

YA-11I
YA-11D
FOR: RONIS®

FOR: ABUS®
BENDIX®
CAB®
CHICAGO®
COLE HERSEE®

USA GB
ALU.

FOR: MAGIRUS DEUTZ®

BH-1
FOR: BOSCH®
FOR: NEIMAN®

BH-1.P
FOR: BOSCH®
FOR: NEIMAN®

BH-2
FOR: BOSCH®

LAS-R
LAS-V
LAS-Y
FOR: LAS®
FOR: DUBOIS®-KIFERM®-PJ®-PK®

PRE-1I
PRE-3
FOR: PRESTA®
FOR: LAPORTE®

FOR: MAGIRUS DEUTZ®

RO-2I
FOR: RONIS®
FOR: ABSA®-FROSER®-PJ®-SADV®

RO-2D
RO-4I
RO-4D
RO-6I
RO-6D
FOR: RONIS®
FOR: ABSA®-FROSER®-PJ®-SADV®

FOR: MAN®

BH-1
FOR: BOSCH®
FOR: NEIMAN®

BH-1.P
FOR: BOSCH®
FOR: NEIMAN®

BL-2
BL-3
BL-4
BL-6
BL-4D
BL-6D
FOR: BLAU®
FOR: FORT®-HK®-WASO®

FOR: MAN®

FO-OL
FOR: FORD®
FOR: CASI®-YMOS®

FO-OR
FOR: FORD®

HU-MN
FOR: HUF®

FOR: MAN®

HU-SR
FOR: HUF®
FOR: AKS®

FOR: MERCEDES ARG.®

VO-M
VO-R.P
FOR: AKS®-CASI®-WITTE®

ME-9.P
FOR: HUF®

Concerning the marks and commercial denominations see legal warning.
Concerniente a las marcas y denominaciones comerciales ver aviso legal.
Marka eta izendapen komertzialiei dagokienez, ikus lege-oharra.
Concernant les marques et dénominations commerciales voir la note dans l'index.

JMA Opening the future

JMA Opening the future

Beziehen auf die Marke und Handelsname sehen Sie die Notiz im Impressum.
Relativamente às marcas e denominações comerciais, ver aviso legal.
Jeśli chodzi o znaki i nazwy handlowe, patrz Informacje prawne.

K04 / 307

FOR: MERCEDES (ARGENTINA) ®

TX
ME-13D.P
FOR: HUF ®

ME-14.P
FOR: HUF ®

ME-HD.P
FOR: HUF ®

ME-HZ.P
FOR: HUF ®

ME-HM.P
FOR: YMOS ®

ME-HML.P
FOR: HUF ®
FOR: YMOS ®

..HF..
1-99/1-99
HD 4001-7350
NZ 0001-1400
NZ 2001-2500
NZ 1-99/1-99

HF 0001-1200
NM....
0001-1200
4001-7350

HZ 0001-1400
HZ 2001-3500
HZ 4001-5000
ND
4001-5795
5801-7350
HZ 1-99/1-99

HM 0001-1200
2501-3500
4001-5795
5801-7350
NF 0001-1200
..NF..
1-99/1-99

HM 0001-1200
2501-3500
4001-5795
5801-7350
NF 0001-1200
..NF..
1-99/1-99

FOR: NISSAN ®

X
0001-8000
DAT-6
DAT-6D

Y
0001-8000
8001-9000
DAT-7
FOR: NISSAN ®
FOR: DATSUN ®

X
0001-8000
DAT-6.P
DAT-6D.P

Y
0001-8000
8001-9000
DAT-7.P
FOR: NISSAN ®
FOR: DATSUN ®

X
0001-9000
DAT-12
FOR: NISSAN ®

FOR: MERCEDES ®

FOR: MITSUBISHI ®

L
001-300
ME-L
FOR: HUF ®
FOR: IMSA ® -YMOS ®

S
101-295
401-465
501-695
ME-S
FOR: HUF ®
FOR: CASI ®

H
001-400
2221-2620
4441-4640
4641-5143
E
2001-3000
MIT-2I
FOR: MITSUBISHI ® -SUZUKI ®

H
001-400
2221-2620
4441-4640
4641-5143
E
2001-3000
MIT-2I.P
MIT-2D.P
FOR: MITSUBISHI ® -SUZUKI ®

H
001-400
2221-2620
4441-4640
4641-5143
E
2001-3000
MIT-9
FOR: MITSUBISHI ® -SUZUKI ®

FOR: NISSAN ®

FOR: PEGASO ®

.....
...A/Z
B-C-D-E
1/9...A/Z
1/9...A/Z
.....A/Z
B-D-E-G-H-J
.1/9...A/Z
.1/9...A/Z
E-M-N-P-R
NE-22.P
FOR: NEIMAN ®
CLAUSOR ®

FOR:
A.MOTORS
RENAULT ®
DAF ®
NISSAN ®

ROS-2
FOR: ROSS ®

FOR:
AKS ®
CASI ®
NEIMAN ®
UBE ®
WITTE ®
YMOS ®

HV....
1-854
1001-9282
AU-1
FOR: HUF ®

FOR:
AKS ®
CASI ®
NEIMAN ®
UBE ®
WITTE ®
YMOS ®

HV....
1-854
1001-9282
AU-HV
FOR: HUF ®

FOR:
AKS ®
CASI ®
NEIMAN ®
UBE ®
WITTE ®
YMOS ®

HV....
1-854
1001-9282
AU-HV.P
FOR: HUF ®

FOR: MITSUBISHI ®

FOR: NISSAN ®

H
0001-0400
2221-2620
4441-5143
MIT-10
FOR: MITSUBISHI ®

H
0001-0400
2221-2620
4441-5143
MIT-11D
FOR: MITSUBISHI ®

.....
...A/Z
B-C-D-E
1/9...A/Z
1/9...A/Z
.....A/Z
B-D-E-G-H-J
.1/9...A/Z
.1/9...A/Z
E-M-N-P-R
CHR-3
FOR: CHRYSLER ®
FOR: CLAUSOR ® -NEIMAN ®

FOR:
A.MOTORS
CITROEN ®
MAZDA ®
PEUGEOT ®
RENAULT ®
TALBOT
DAF ®
NISSAN ®
PEGASO ®

CHR-5
FOR: CHRYSLER ®
FOR: ROSS ®

FOR: PEGASO ®

A...
101-125
501-598
701-790
BL-2
B...
201-225
BL-3

A
BL-4
BL-6
FOR: BLAU ®
FOR: FORT ® -HK ® -WASO ®

.....
...A/Z
B-C-D-E
1/9...A/Z
1/9...A/Z
.....A/Z
B-D-E-G-H-J
.1/9...A/Z
.1/9...A/Z
E-M-N-P-R
CHR-3
FOR: CHRYSLER ®
FOR: CLAUSOR ® -NEIMAN ®

FOR:
A.MOTORS
CITROEN ®
MAZDA ®
PEUGEOT ®
RENAULT ®
TALBOT
DAF ®
NISSAN ®
PEGASO ®

.....
...A/Z
B-C-D-E
1/9...A/Z
1/9...A/Z
.....A/Z
B-D-E-G-H-J
.1/9...A/Z
.1/9...A/Z
E-M-N-P-R
CHR-3.P
FOR: CHRYSLER ®
FOR: CLAUSOR ® -NEIMAN ®

FOR:
A.MOTORS
CITROEN ®
MAZDA ®
PEUGEOT ®
RENAULT ®
TALBOT
DAF ®
NISSAN ®
PEGASO ®

CHR-5
FOR: CHRYSLER ®
FOR: ROSS ®

3
0501-1000
IMS-3
1
0501-1000
IMS-5
IMS-13
FOR: CROMODORA ® -FIST ® -JMSA ®

4
0501-1000
AF-21
2
0501-1000
AF-19

Concerning the marks and commercial denominations see legal warning.
Concarniente a las marcas y denominaciones comerciales ver aviso legal.
Marka eta izendapen komertzialiei dagokienez, ikus lege-oharra.
Concernant les marques et denominations commerciales voir la note dans l'index.

FOR: PEGASO®

IMS-3.P
 0501-1000
 FOR: SAFE®
 FOR: CROMODORA® -FIST® -IMSA®

AF-21.P
 0501-1000
 FOR: NEIMAN®
 FOR: CLAUSOR®

ROS-2
 FOR: ROSS®

VO-AH
 AH....
 1-8154
 1001-9282
 HV....
 1-8154
 1001-9282
 VO-HV
 VB-NV-MD....
 1-8154
 1001-9282
 VO-VB
 N....
 VO-N
 FOR: HUF®
 FOR: AKS® -CASI® -UBE® -WITTE®

AN....
 001-854
 1001-1918
 2001-2830
 3001-3890
 4001-5151
 6001-7086
 7001-8154
 8201-9282
AU-AN

FOR: RENAULT SAVIEM®

CHR-3
 FOR: CHRYSLER®
 FOR: CLAUSOR® -NEIMAN®

CHR-3.P
 FOR: CHRYSLER®
 FOR: CLAUSOR® -NEIMAN®

DAV-1
 FOR: DAV®

DAV-1.P
 FOR: DAV®

LAS-R
 FOR: LAS®

LAS-V
 FOR: LAS®

LAS-Y
 FOR: LAS®

LAS-R
 FOR: DUBOIS® -KIFERM® -PJ® -PK®

FOR: PEGASO®

FOR: PIAGGIO®

VO-AH.P
 AH....
 1-8154
 1001-9282
VO-HV.P
 HV....
 1-8154
 1001-9282
VO-VB.P
 VB-NV-MD....
 1-8154
 1001-9282
VO-N.P
 N....
 FOR: HUF®
 FOR: AKS® -CASI® -UBE® -WITTE®

AF-7I
 A
 0501-3278
 0,4,6,8,9
AF-8I
 H
 01-78
AF-9I
 F
 01-78
AU-AN.P
 AN....
 001-854
 1001-1918
 2001-2830
 3001-3890
 4001-5151
 6001-7086
 7001-8154
 8201-9282

AF-7D
 G
 01-78
AF-8D
 G
 01-78
AF-9D
 E
 01-78
FAB-1
 2
 100-309
 FOR: SIPEA®
 FOR: SAFE®

FOR: RENAULT SAVIEM®

LMP-3
 35001-36177
 70001-72500
 75000-77500
 1AA-7FZ
LMP-4
 FOR: LMP®
 FOR: GELBON® -SEIMA®

LMP-5
 70001-72500
 75000-77500
 1AA-7FZ
LMP-4.P1
 FOR: LMP®
 FOR: GELBON® -SEIMA®

LMP-5.P1
 FOR: LMP®
 FOR: GELBON® -SEIMA®

NE-3
 FOR: NEIMAN®
 FOR: CLAUSOR®

NE-3D
 FOR: NEIMAN®
 FOR: CLAUSOR®

NE-3.P
 FOR: NEIMAN®
 FOR: CLAUSOR®

NE-3.P1
 FOR: NEIMAN®
 FOR: CLAUSOR®

FOR: PIAGGIO®

FOR: RENAULT SAVIEM®

FEM-1I
 F
 01-78
FEM-2I
 H
 01-78
FEM-3I
 FOR: FEMSA®

FEM-1D
 E
 01-78
FEM-2D
 G
 01-78
FEM-3D
 FOR: NEIMAN®

NE-6
 .0.../...0...
 ...0.../...0...
 AA.../BA...
 CA.../EA...
 Z.../Z...
 ...Z.../...Z...
 ...Z.../...Z...
 1 AL 5
 FOR: NEIMAN®

NE-6.P
 .0.../...0...
 ...0.../...0...
 AA.../BA...
 CA.../EA...
 Z.../Z...
 ...Z.../...Z...
 ...Z.../...Z...
 1 AL 5
 FOR: NEIMAN®

BH-1
 E,M,N,U,H,K
 001-100
 HG,N
 140-189
 040-100
 FOR: BOSCH®
 FOR: NEIMAN®

BH-1.P
 E,M,N,U,H,K
 001-100
 HG,N
 140-189
 040-100
 FOR: BOSCH®
 FOR: NEIMAN®

FOR: RENAULT SAVIEM®

NE-3.P2
 FOR: NEIMAN®
 FOR: CLAUSOR®

NE-19
 FOR: NEIMAN®

NE-19.P
 FOR: NEIMAN®

NE-22.P
 FOR: NEIMAN®
 FOR: CLAUSOR®

NE-28
 FOR: NEIMAN®

Concerning the marks and commercial denominations see legal warning.
 Concerniente a las marcas y denominaciones comerciales ver aviso legal.
 Marka eta izendapen komertzialiei dagokienez, ikus lege-oharra.
 Concernant les marques et denominations commerciales voir la note dans l'index.

JMA Opening the future

JMA Opening the future

Beziehen auf die marke und handelsname sehen sie die notiz im Impressum.
 Relativamente às marcas e denominações comerciais, ver aviso legal.
 Jeśli chodzi o znaki i nazwy handlowe, patrz Informacje prawne.

FOR: RENAULT SAVIEM®

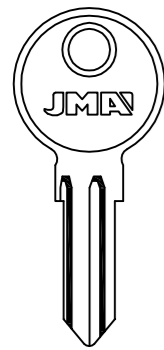

J...
001-224
FOR: PJ®
FOR: KIFERM®

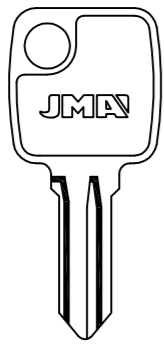

J...
001-224
FOR: PJ®
FOR: KIFERM®

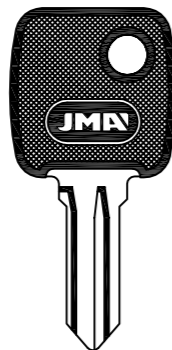

J...
001-224
FOR: PJ®
FOR: KIFERM®

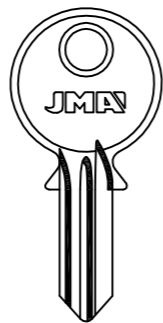

A8..AA-DS
..8AB-ZZ
S...385-402
RO-11

A9..AA-DS
..8AB-ZZ
S...403-420
RO-1D

FOR: RONIS®
FOR: ABSA® -FROSER® -PJ® -SADV®

..4AB-ZZ
S...331-348
RO-2I

AA-JZ
A4../A.4.
RO-4I

AB-ZZ
..6
S...349-366
RO-6I

..3AB-ZZ
...1 AL 4
RO-2D

AA-JZ
A3../A.3.
S...213-246
RO-4D

AB-ZZ
..7
S...367-384
RO-6D

FOR: RENAULT SAVIEM®

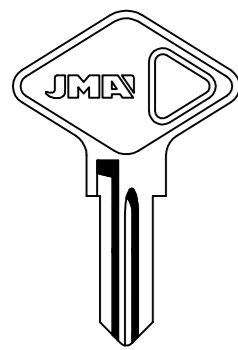

70.....
1 AL 3
...1-975
RO-15
FOR: RONIS®

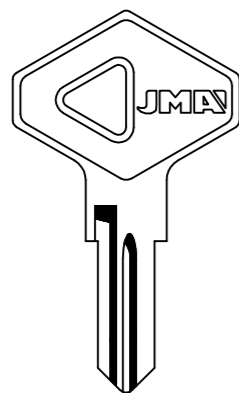

77....
0 AL 3
RO-17
FOR: RONIS®

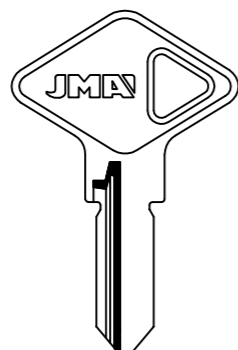

1R...000-999
2R...1000-1837
3R...000-665
VA-7
FOR: VACHETTE®

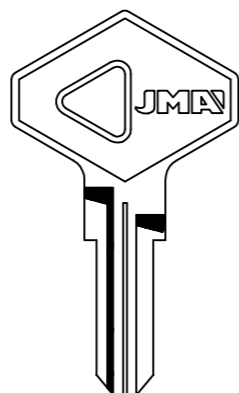

A/Z....
...A/Z
...A/Z 1/9
2700-4816
VA-10
FOR: VACHETTE®

FOR: ROVER®

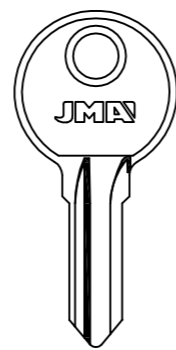

R
001-224
LAS-R



FOR: LAS®
FOR: DUBOIS® -KIFERM® -PJ® -PK®

V
001-224
LAS-V



Y
001-224
LAS-Y

FOR: ROVER®

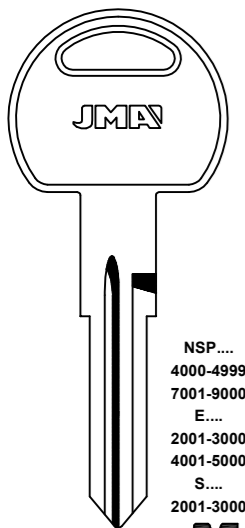

FOR: NEIMAN®

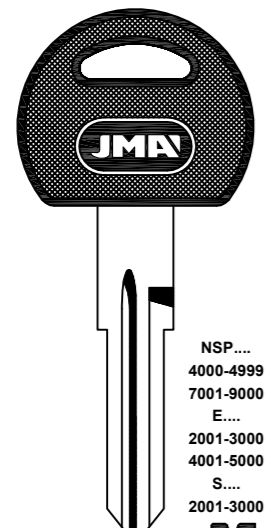

FOR: NEIMAN®

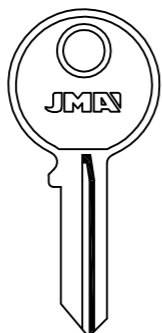

FS...1-99
FS...876-955
UN-1FS

NRA
FFE...1-100
FJA...1-100
FL...251-500
NRA...51-90
YFB...1-75
FMD...1-75
FG...1-30
NF...1-30
EJR...1-75
UN-FFE
MC...1-40
MRA...251-290
MRN...1-54
MRN...201-250
MRN...251-300
UN-MRN
FA...
501-625
UN-44
FOR: UNION®

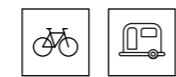

UN-3

HX...100
UN-2

RM...
911-952
UN-44D

FP...
626-750
UN-FP

FR...
751-875
UN-FR

NGN...1-54
UN-NG

FOR: SCANIA®

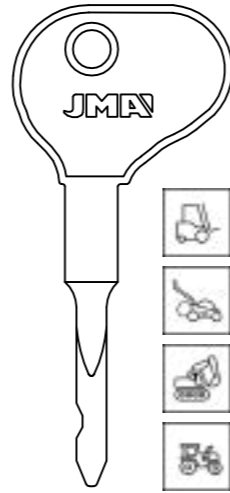

BH-2
FOR: BOSCH®

FOR: SCANIA®

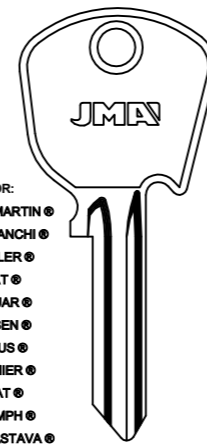

FOR:
ASTON MARTIN®
AUTOBIANCHI®
DAIMLER®
FIAT®
JAGUAR®
JENSEN®
LOTUS®
PREMIER®
SEAT®
TRIUMPH®
YUGO ZASTAVA®
SCANIA®
FK
1-3040
FO-FK
FOR: FORD®
FOR: ARMAN® -DOM® -JUGODENT® -WASO®

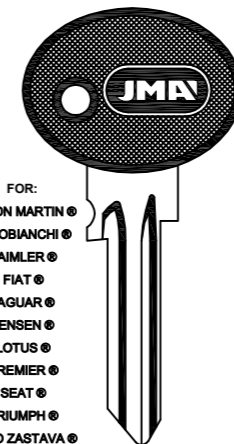

FOR:
ASTON MARTIN®
AUTOBIANCHI®
DAIMLER®
FIAT®
JAGUAR®
JENSEN®
LOTUS®
PREMIER®
SEAT®
TRIUMPH®
YUGO ZASTAVA®
SCANIA®
FK
1-3040
FO-FK.P
FOR: FORD®

FR
1-3040
4001-6000
FO-FR
FOR: FORD®

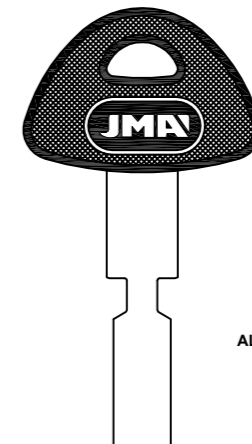

ALP.
...
1-2000
7,6
3,5
HU-2.P
FOR: HUF®

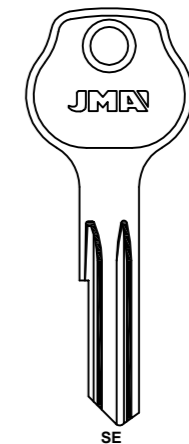

SE
001-750
SC
401-630
HU-SC

FOR: HUF®
FOR: AKS®

SR
001-240
KSR
001-240
LSR
001-240
TSR
001-240
HU-SR



SZ
1-240
HU-SZ

FOR: HUF®
FOR: AKS®

SU
001-240
401-630
HU-SU



SX
001-240
HU-SX



SY
001-240
HU-SY



FOR: SCANIA®

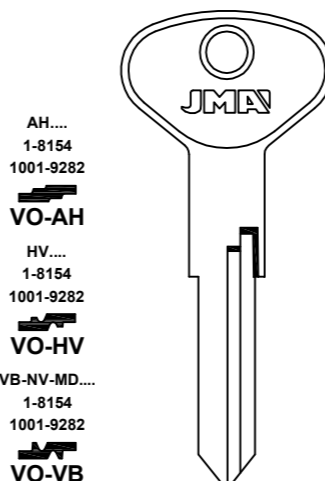

AH...
1-8154
1001-9282
VO-AH

HV...
1-8154
1001-9282
VO-HV

VB-NV-MD...
1-8154
1001-9282
VO-VB

N...
VO-N



FOR: HUF®
FOR: AKS® -CASI® -UBE® -WITTE®

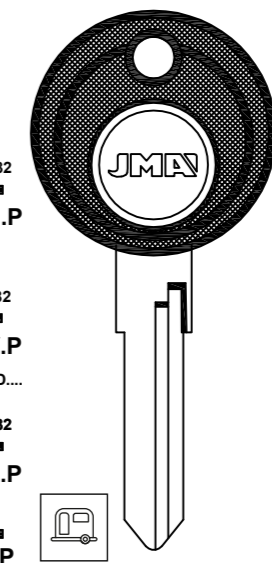

AH...
1-8154
1001-9282
VO-AH.P

HV...
1-8154
1001-9282
VO-HV.P

VB-NV-MD...
1-8154
1001-9282
VO-VB.P

N...
VO-N.P



FOR: HUF®
FOR: AKS® -CASI® -UBE® -WITTE®

AN...
001-854
1001-1918
2001-2830
3001-3890
4001-5151
6001-7086
7001-8154
8201-9282
AU-AN.P

FOR: AKS®

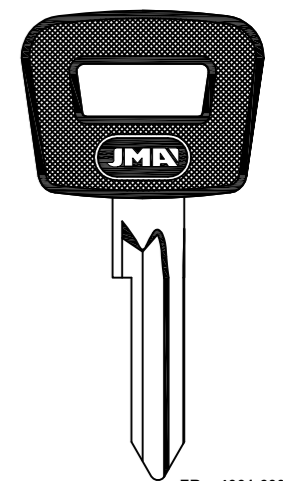

FR...4001-6000
FZ...1-1232
WAS-2.P

FOR: WASO®
FOR: ARMAN® -DOM®

FOR: SCANIA®

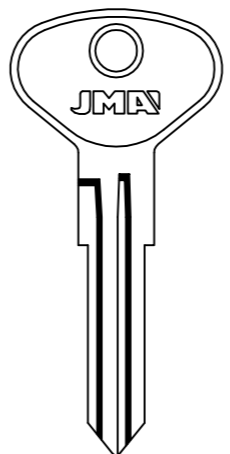

8001-8100
WIT-1
FOR: WITTE®

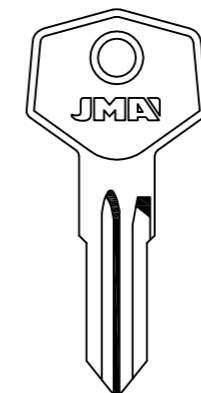

KA
001-100
AKS-1
FOR: AKS®

FOR: STEYR PUCH®

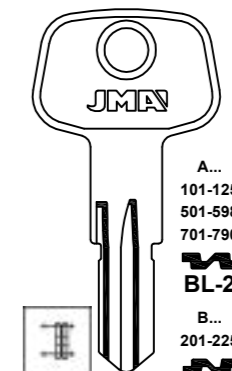

A...
101-125
501-598
701-790
BL-2

B...
201-225
BL-3

A
BL-4

A 201-225
BL-6

B...
101-125
BL-4D

B 101-125
BL-6D

FOR: BLAU®
FOR: FORT® -HK® -WASO®

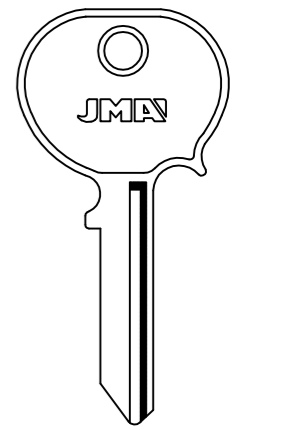

...A
...D
...F
1 AL 5
NE-25
FOR: NEIMAN®

Concerning the marks and commercial denominations see legal warning.
Concerniente a las marcas y denominaciones comerciales ver aviso legal.
Marka eta izendapen komertzialiei dagokienez, ikus lege-oharra.
Concernant les marques et denominations commerciales voir la note dans l'index.

FOR: STEYR PUCH®

FOR: TATA®

AH....
1-8154
1001-9282

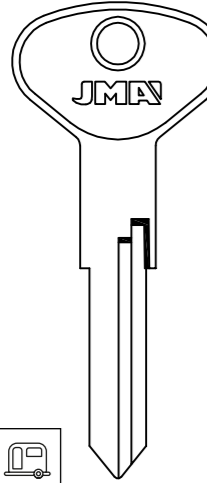

VO-AH

HV....
1-8154
1001-9282

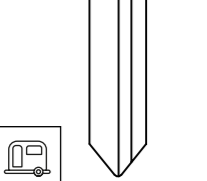

VO-HV

VB-NV-MD....
1-8154
1001-9282



VO-VB

N....
1001-9282



VO-N

FOR: HUF®
FOR: AKS® - CASI® - UBE® - WITTE®

AH....
1-8154
1001-9282

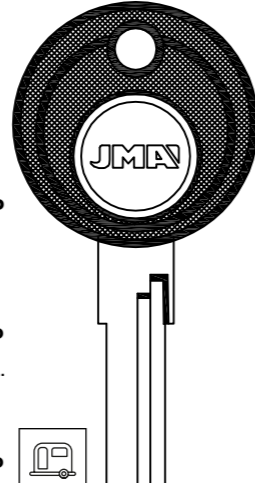

VO-AH.P

HV....
1-8154
1001-9282

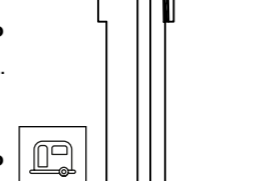

VO-HV.P

VB-NV-MD....
1-8154
1001-9282



VO-VB.P

N....
1001-9282



VO-N.P

AN....
001-854
1001-1918
2001-2830
3001-3890
4001-5151
6001-7086
7001-8154
8201-9282

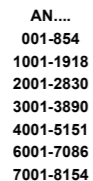

AU-AN

FOR: HUF®
FOR: AKS® - CASI® - UBE® - WITTE®

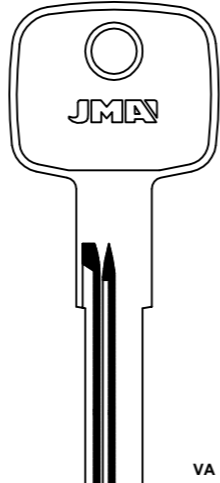

VA
01-50

ME-VA

FOR: HUF®
FOR: CASI®

FOR: TRUCK (USA)®

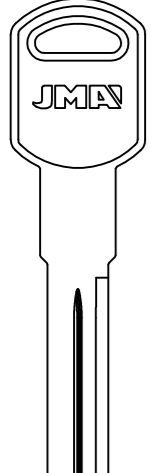

....A00-7N45

GM-14

FOR: G.M.®
FOR: BRIGGS STRATTON®

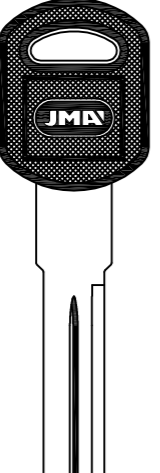

....A00-7N45

GM-14.P

FOR: G.M.®
FOR: BRIGGS STRATTON®

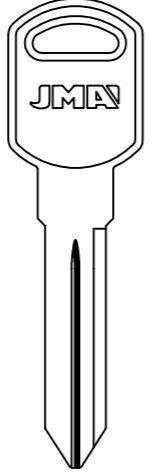

....A00-7N45

GM-25

FOR: G.M.®
FOR: BRIGGS STRATTON®

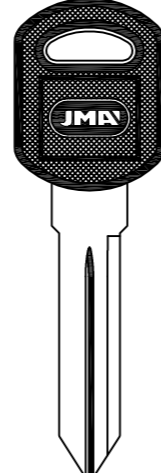

....A00-7N45

GM-25.P

FOR: G.M.®
FOR: BRIGGS STRATTON®

FOR: VOLKSWAGEN®

FOR: VOLVO®

AH....
1-8154
1001-9282

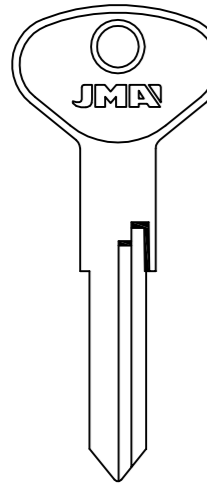

VO-AH

HV....
1-8154
1001-9282

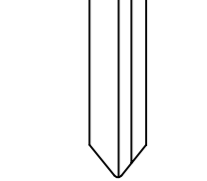

VO-HV

VB-NV-MD....
1-8154
1001-9282

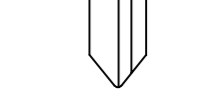

VO-VB

N....
1001-9282



VO-N

FOR: HUF®
FOR: AKS® - CASI® - UBE® - WITTE®

AH....
1-8154
1001-9282

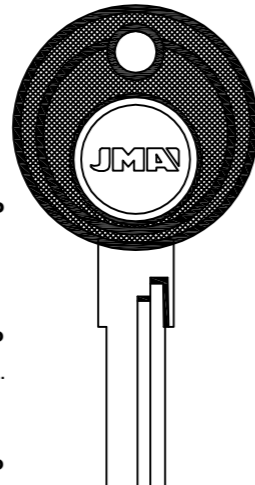

VO-AH.P

HV....
1-8154
1001-9282

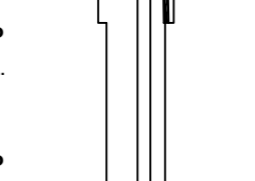

VO-HV.P

VB-NV-MD....
1-8154
1001-9282



VO-VB.P

N....
1001-9282



VO-N.P

AN....
001-854
1001-1918
2001-2830
3001-3890
4001-5151
6001-7086
7001-8154
8201-9282

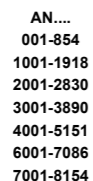

AU-AN

FOR: HUF®
FOR: AKS® - CASI® - UBE® - WITTE®

R
001-224

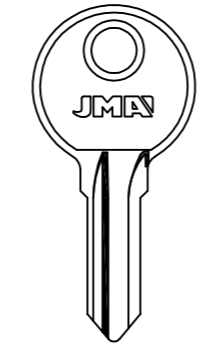

LAS-R

V
001-224



LAS-V

Y
001-224

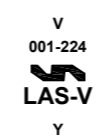

LAS-Y

FOR: LAS®
FOR: DUBOIS® - KIFERM® - PJ® - PK®

FOR: VOLVO®

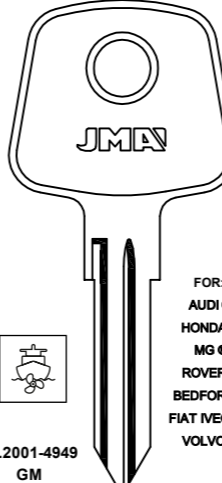

FOR: AUDI®
HONDA®
MG®
ROVER®
BEDFORD®
FIAT (VECO)®
VOLVO®

....2001-4949
GM®

....2001-3000

NE-1

FOR: NEIMAN®
FOR: CLAUSOR®

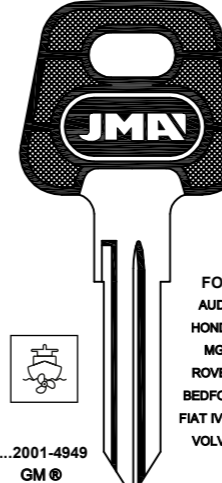

FOR: AUDI®
HONDA®
MG®
ROVER®
BEDFORD®
FIAT (VECO)®
VOLVO®

....2001-4949
GM®

....2001-3000

NE-1.D

FOR: NEIMAN®
FOR: CLAUSOR®

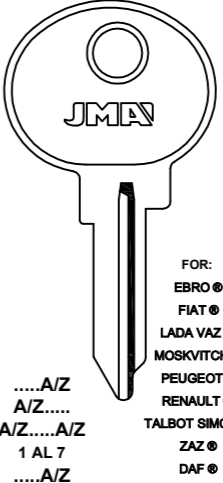

FOR: EBRO®
FIAT®
LADA VAZ®
MOSKVITCH®
PEUGEOT®
RENAULT®
TALBOT SIMCA®
ZAZ®
DAF®
VOLVO®

....A/Z
A/Z.....
A/Z.....A/Z

1 AL 7
....A/Z
0 AL 9

NE-3

FOR: NEIMAN®
FOR: CLAUSOR®



FOR: EBRO®
FIAT®
LADA VAZ®
MOSKVITCH®
PEUGEOT®
RENAULT®
TALBOT SIMCA®
ZAZ®
DAF®
VOLVO®

....A/Z
A/Z.....
A/Z.....A/Z

1 AL 7
....A/Z
0 AL 9

NE-3.D

FOR: NEIMAN®
FOR: CLAUSOR®

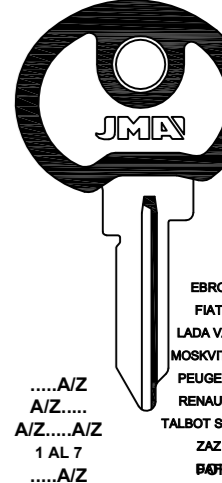

FOR: EBRO®
FIAT®
LADA VAZ®
MOSKVITCH®
PEUGEOT®
RENAULT®
TALBOT SIMCA®
ZAZ®
DAF®
VOLVO®

....A/Z
A/Z.....
A/Z.....A/Z

1 AL 7
....A/Z
0 AL 9

NE-3.P

FOR: NEIMAN®
FOR: CLAUSOR®

FOR: VOLVO®

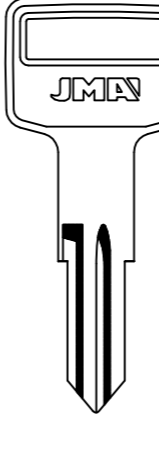

....6250-6499

NE-9

FOR: NEIMAN®
FOR: CLAUSOR®

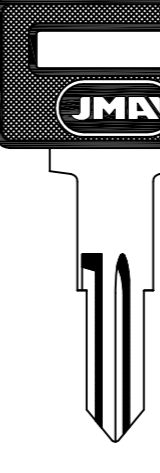

....6250-6499

NE-9.P

FOR: NEIMAN®
CLAUSOR®

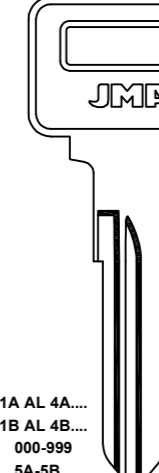

1A AL 4A....
1B AL 4B....
000-999
5A-5B...
000-746

NE-12

FOR: NEIMAN®

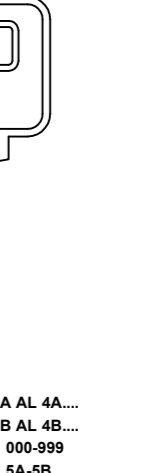

1A AL 4A....
1B AL 4B....
000-999
5A-5B...
000-746

NE-18

FOR: NEIMAN®

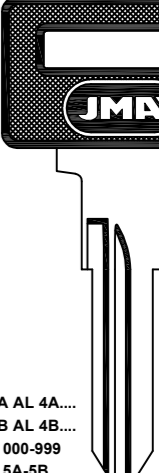

1A AL 4A....
1B AL 4B....
000-999
5A-5B...
000-746

NE-12.P

FOR: NEIMAN®



1A AL 4A....
1B AL 4B....
000-999
5A-5B...
000-746

NE-18.P

FOR: NEIMAN®

FOR: VOLVO®

FOR: WHITE®

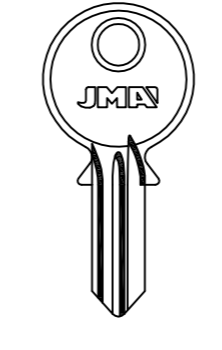

A8..AA-DS
..8AB-ZZ
S...385-402

RO-11

A9..AA-DS
..8AB-ZZ
S...403-420

RO-1D

FOR: ABSA® - FROSER® - PJ® - SADV®

..4AB-ZZ
S...331-348

RO-2I

AA-JZ
A4..A.A.
RO-4I
AB-ZZ
..6
S...349-366

RO-6I

FOR: RONIS®

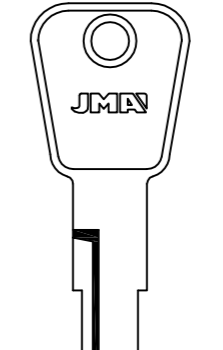

..3AB-ZZ
...1 AL 4
RO-2D
AA-JZ
A3..A.3.
S...213-246

RO-4D

AB-ZZ
..7
S...367-384

RO-6D

W...
600-842

WAS-1

FOR: WASO®

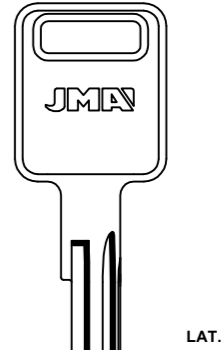

LAT.

AMM-1

FOR: AMERICAN MOT.®

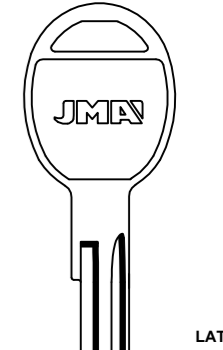

LAT.

AMM-2

FOR: AMERICAN MOT.®

Concerning the marks and commercial denominations see legal warning.
Concerniente a las marcas y denominaciones comerciales ver aviso legal.
Marka eta izendapen komertzialiei dagokienez, ikus lege-oharra.
Concernant les marques et denominations commerciales voir la note dans l'index.

JMA Opening the future

JMA Opening the future

Beziehen auf die Marke und Handelsname sehen Sie die Notiz im Impressum.
Relativamente às marcas e denominações comerciais, ver aviso legal.
Jeśli chodzi o znaki i nazwy handlowe, patrz Informacje prawne.

FOR: WHITE®

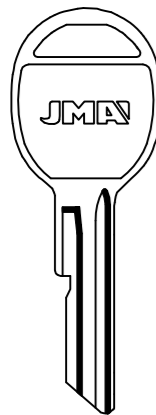

E...225-814
L...1-1000
BS-2
FOR: B & S®

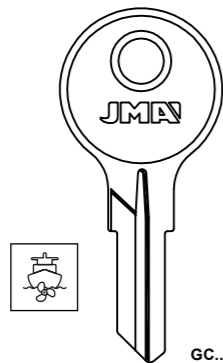

A...250-1500
AP...250-1500
B...250-1500
C...1251-1700
CB...250-1500
DC-EP...250-699
P...250-1500
BS-6
FOR: B & S®

LAT.

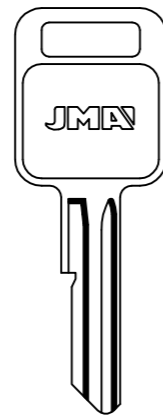

D
225-814
K
01-1000
BS-5
FOR: B & S®
FOR: POLLAK® - BOBCAT®

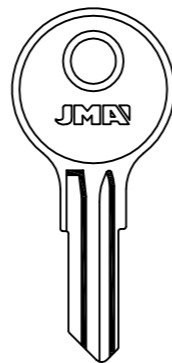

A...201-1050
C...500-699
H...601-1100
HM...201-1050
HUD-1
FOR: HUDSON®

FOR: APRILIA®

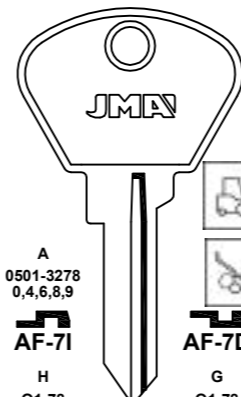

A
0501-3278
0,4,6,8,9
AF-71

H
01-78
AF-81

F
01-78
AF-91

FOR: SIPEA®
FOR: SAFE®

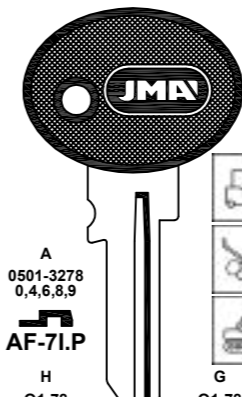

A
0501-3278
0,4,6,8,9
AF-71.P

H
01-78
AF-81.P

F
01-78
AF-91.P

FOR: SIPEA®
FOR: SAFE®

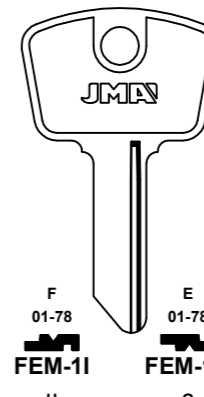

F
01-78
FEM-11

H
01-78
FEM-21

F
01-78
FEM-31

FOR: FEMSA®

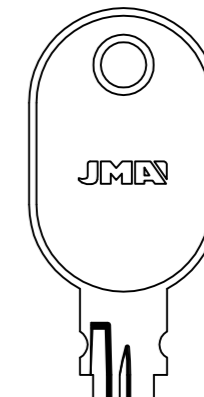

N 6001-7000
J 3001-6732
V 0001-3051
V 5001-8058
AB 6001-6891
FI-11

FOR: GIOBERT®
FOR: RAYTON FISSORE® - STEYR PUCH® - APRILIA®



N 6001-7000
J 3001-6732
V 0001-3051
V 5001-8058
AB 6001-6891
FI-11.P

FOR: GIOBERT®

FOR: APRILIA®

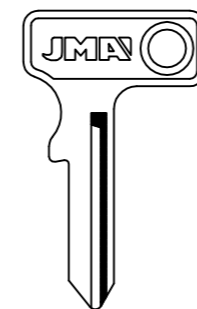

.0.../...0...
...0/0...0
AA.../BA...
CA...
1 AL 5
NE-8

FOR: NEIMAN®
FOR: CLAUSOR®

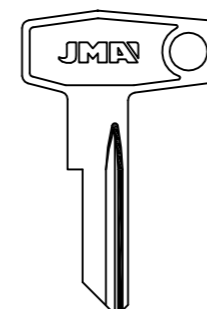

...1-1625
...5001-6278
E...1-710
ZA-1

FOR: ZADI®
FOR: BRETER®

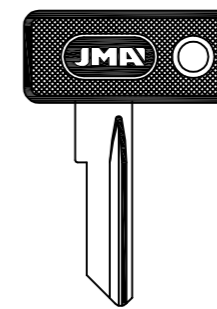

...1-1625
...5001-6278
E...1-710
ZA-1.P

FOR: ZADI®
FOR: BRETER®

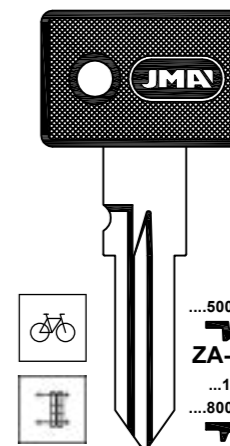

...5001-6475
ZA-13.P
...1-700
...8001-9554
ZA-4D.P
...2001-3554
...8001-9554
ZA-2.P

FOR: ZADI®
FOR: BASTA® - VIRO® - LML®

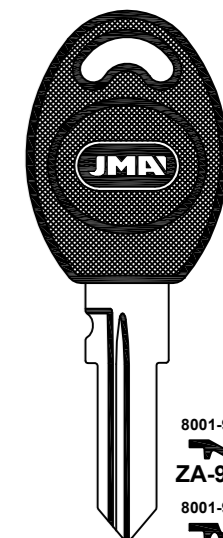

8001-9554
ZA-9.P2
8001-9554
ZA-6D.P1

FOR: ZADI®

FOR: APRILIA®

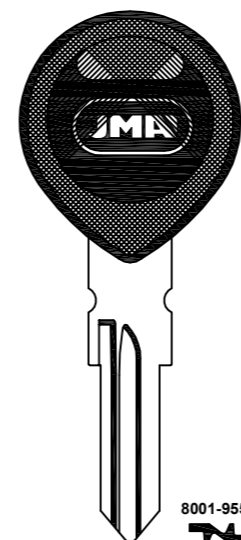

8001-9554
ZA-9.P1

FOR: ZADI®

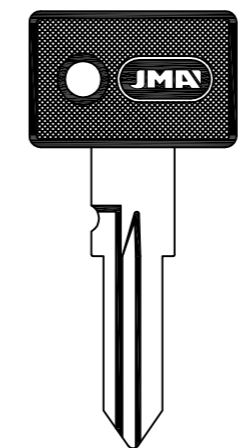

...5001-6475
ZA-13.P

FOR: ZADI®
FOR: LML®

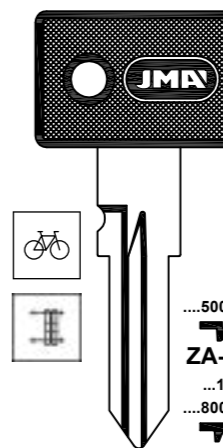

...5001-6475
ZA-13.P
...1-700
...8001-9554
ZA-4D.P
...2001-3554
...8001-9554
ZA-2.P

FOR: ZADI®
FOR: BASTA® - VIRO® - LML®

FOR: ATALA®

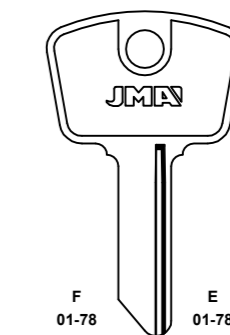

F
01-78
FEM-11

H
01-78
FEM-21

F
01-78
FEM-31

FOR: FEMSA®

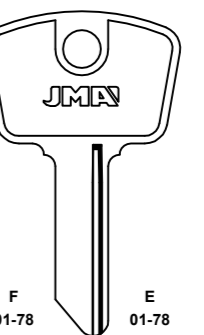

E
01-78
FEM-1D

G
01-78
FEM-2D

F
01-78
FEM-3D

FOR: FEMSA®

FOR: BENELLI®

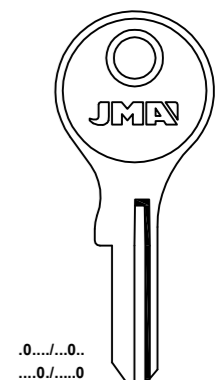

.0.../...0...
...0/0...0
AA.../BA...
CA.../EA...
Z.../Z...
...Z.../Z...
...Z.../Z...
1 AL 5
NE-6

FOR: NEIMAN®

Concerning the marks and commercial denominations see legal warning.
Concerniente a las marcas y denominaciones comerciales ver aviso legal.
Marka eta izendapen komertzialiei dagokienez, ikus lege-oharra.
Concernant les marques et denominations commerciales voir la note dans l'index.

FOR: BENELLI®

.0.../...0...
 ...0.../...0...
 AA.../BA...
 CA.../EA...
 Z.../Z...
 ..Z.../Z...
 ...Z.../...Z...
 1 AL 5
NE-6.P
 FOR: NEIMAN®

.0.../...0...
 ...0.../...0...
 AA.../BA...
 CA...
 1 AL 5
NE-8
 FOR: NEIMAN®
 FOR: CLAUSOR®

...1-1625
 ...5001-6278
 E...1-710
ZA-1
 FOR: ZADI®
 FOR: BRETER®

...1-1625
 ...5001-6278
 E...1-710
ZA-1.P
 FOR: ZADI®
 FOR: BRETER®

FOR: BETA®

FOR:
 CROMODORA®
 FIST®
 FREA®
 GIOBERT®
 MIRAGLIO®
 RUFFINI®

6
 100-309
AF-5I
 2
 100-309
AF-6I

8
 100-309
AF-5D
 4
 100-309
AF-6D
 FOR: SAFE®

FOR: BICICLETTA-CYCLES®

NRA
 FFE...1-100
 FJA...1-100
 FL...251-500
 NRA...51-90
 YFB...1-75
 FMD...1-75
 FG...1-30
 NF...1-30
 EJ.R...1-75
UN-FFE
 MC...1-40
 MRA...251-290
 MRN...1-54
 MRN...201-250
 MRN...251-300
UN-MRN
 FA...
 501-625
UN-44
 FOR: UNION®

FP...
 626-750
UN-FP
 FR...
 751-875
UN-FR
 RM...
 911-952
UN-44D
 NGN...1-54
UN-NG

95001-97000
 97001-99000
LF-2
 FS...1-99
 FS...876-955
UN-1FS
 HX...100
UN-2
 FOR: L. & F.®
 FOR: DOBLE SAFE® -EURO LOCKS®

FOR: BIMOTA®

6
 100-517
FAR-1I
 2
 100-517
FAR-2I
 H
 100-309
FAR-3
 8
 100-517
FAR-1D
 4
 100-517
FAR-2D
FAR-3D
FAR-4D
 FOR: FARMA®
 FOR: FISAM®

FOR: BETA®

...5001-6475
ZA-13.P
 ...1-700
 ...8001-9554
ZA-4D.P
 ...2001-3554
 ...8001-9554
ZA-2.P
 8001-9554
ZA-9.P2
 8001-9554
ZA-6D.P1
 FOR: ZADI®

2
 100-309
FAB-1
 FOR: FAAB®

...1-1625
 ...5001-6278
 E...1-710
ZA-1
 FOR: ZADI®
 FOR: BRETER®

...1-1625
 ...5001-6278
 E...1-710
ZA-1.P
 FOR: ZADI®
 FOR: BRETER®

...5001-6475
 ...1-700
 ...8001-9554
ZA-13.P
 ...2001-3554
 ...8001-9554
ZA-2.P
 FOR: ZADI®
 FOR: BASTA® -VIRO® -LML®

FOR: BIMOTA®

...
 101-499
 751-795
 A00-A99
SUZU-4I
 FOR: SUZUKI®

...
 101-499
 751-795
 A00-A99
SUZU-4D
 FOR: SUZUKI®

...
 101-499
 751-795
 A00-A99
SUZU-4I.P
 FOR: SUZUKI®

...
 101-499
 751-795
 A00-A99
SUZU-4D.P
 FOR: SUZUKI®

...
 101-499
 751-795
SUZU-5
 FOR: SUZUKI®

FOR: BETA®

8001-9554
ZA-9.P1
 FOR: ZADI®

FOR: BICICLETTA-CYCLES®

7000-7999
 A....
 7000-7999
AS-2I

8000-9999
 A....
 9000-9999
AS-21D

7000-7999
 A....
 7000-7999
AS-21.P

8000-9999
 A....
 9000-9999
AS-21D.P

21...
 0001-9999
AS-17D
 FOR: ASSA®

7000-7999
 A....
 7000-7999
AS-2I

6000-8999
 A....
 9000-9999
AS-2D
 FOR: ASSA®

21...
 0001-9999
AS-17D
 FOR: ASSA®

7000-7999
 A....
 7000-7999
AS-21

8000-9999
 A....
 9000-9999
AS-21D
 FOR: ASSA®

7000-7999
 A....
 7000-7999
AS-21.P

8000-9999
 A....
 9000-9999
AS-21D.P
 FOR: ASSA®

FOR: BIMOTA®

101-499
 751-795
 A00-A99
SUZU-5.P
 FOR: SUZUKI®

...
 101-499
 751-795
 A00-A99
SUZU-13.P
 FOR: LAVERDA® -AUGUSTA® -PEUGEOT® -SUZUKI®

...
 101-499
 751-795
 A00-A99
SUZU-13D.P
 FOR: SUZUKI®

...1-1625
 ...5001-6278
 E...1-710
ZA-1
 FOR: ZADI®
 FOR: BRETER®

...1-1625
 ...5001-6278
 E...1-710
ZA-1.P
 FOR: ZADI®
 FOR: BRETER®

FOR: BMA®

A
 0501-3278
 0,4,6,8,9
AF-7I
 H
 01-78
AF-8I
 F
 01-78
AF-9I

G
 01-78
AF-8D
 E
 01-78
AF-9D
 FOR: SIPEA®
 FOR: SAFE®

Concerning the marks and commercial denominations see legal warning.
 Concerniente a las marcas y denominaciones comerciales ver aviso legal.
 Marka eta izendapen komertzialiei dagokienez, ikus lege-oharra.
 Concernant les marques et denominations commerciales voir la note dans l'index.



Beziehen auf die marke und handelsname sehen sie die notiz im Impressum.
 Relativamente às marcas e denominações comerciais, ver aviso legal.
 Jeśli chodzi o znaki i nazwy handlowe, patrz Informacje prawne.



FOR: BMA®

A
0501-3278
0,4,6,8,9
AF-7I.P
H
01-78
AF-8I.P
F
01-78
AF-9I.P

F
01-78
FEM-1I
H
01-78
FEM-2I
G
01-78
FEM-1D
G
01-78
FEM-2D
E
01-78
FEM-3I
E
01-78
FEM-3D

NRA
FFE...1-100
FJA...1-100
FL...251-500
NRA...51-90
YFB...1-75
FMD...1-75
FG...1-30
NF...1-30
EJR...1-75

UN-FFE
UN-3
UN-FP

MC...1-40
MRA...251-290
MRN...1-54
MRN...201-250
MRN...251-300

UN-MRN
UN-2
UN-FR

FS...1-99
FS...876-955
UN-1FS

FA...
501-625
UN-44
UN-44D
UN-NG

FP...
626-750
UN-FP

FR...
751-875
UN-FR

RM...
911-952
UN-44D

NGN...1-54
UN-NG

FOR: SIPEA®
FOR: SAFE®

FOR: FEMSA®

FOR: UNION®

FOR: BMW®

A...
101-125
501-598
701-790
BL-2
B...
201-225
BL-3
A
BL-4
A 201-225
BL-6
B 101-125
BL-4D
BL-6D

FOR: BLAU®
FOR: FORT® -HK® -WASO®

FOR: CAGIVA®

J
3001-6732
N
6001-7000
FI-1
J
3001-6732
N
6001-7000
FI-10
J
3001-6732
N
6001-7000
FI-10.P
K 3301-4886
K 7001-8092
T 5000-6027
T 7001-8092
S 0501-3278
H 7001-8092
FI-6I
FOR: GIOBERT®

FOR:
ALFA ROMEO®
AUTOSIANCHI®
CITROEN®
FERRARI®
FIAT®
INNOCENTI®
LANCIA®
PEUGEOT®
YUGO ZASTAVA®
CAGIVA®
DUCATI®
FANTIC MOTOR®
GARELLI®
GILERA®

K 3301-4886
K 7001-8092
T 5000-6027
T 7001-8092
S 0501-3278
H 7001-8092
FI-6I.P2
FOR: GIOBERT®

FOR:
AUTOSIANCHI®
CITROEN®
FERRARI®
FIAT®
LANCIA®
PEUGEOT®
YUGO ZASTAVA®
CAGIVA®
DUCATI®
FANTIC MOTOR®
GARELLI®
GILERA®

K 3301-4886
K 7001-8092
T 5000-6027
T 7001-8092
S 0501-3278
H 7001-8092
FI-6I.P3
FOR: GIOBERT®

FOR: BMW®

H...P
12353-53425
BM-HB.P1
FOR: HUF®
FOR: NEIMAN®

...0.../...0...
...0.../...0...
AA.../BA...
CA.../EA...
Z.../Z...
...Z.../...Z...
...Z.../...Z...
1 AL 5
NE-6
FOR: NEIMAN®

...0.../...0...
...0.../...0...
AA.../BA...
CA.../EA...
Z.../Z...
...Z.../...Z...
...Z.../...Z...
1 AL 5
NE-6.P
FOR: NEIMAN®

...O/H...
...H.../...H...
...H.../...H...
1 AL 5
NE-7
FOR: NEIMAN®

8001-9554
ZA-7D.P1
8001-9554
ZA-6D.P
FOR: ZADI®

FOR: CAGIVA®

LAT.
FIS-1D
FOR: FIST®

B... 1 AL 4
H... 1 AL 4
KAW-6.P
KAW-6D.P
FOR: KAWASAKI®

1001-1500
MER-16
MER-16D
FOR: MERONI®
FOR: LAMA®

...
101-499
751-795
A00-A99
SUZU-4I
SUZU-4D
FOR: SUZUKI®

...
101-499
751-795
A00-A99
SUZU-4I.P
SUZU-4D.P
FOR: SUZUKI®
FOR: LAVERDA® -AUGUSTA® -PEUGEOT® -SUZUKI®

FOR: BUELL®

8001-9554
ZA-9.P1
FOR: ZADI®

FOR: CAGIVA®

K.3301-4886
K.7001-8092
T.5000-6027
T.7001-8092
S.0501-3278
H.7001-8092

K-H
7001-8092
AF-14.P
FOR: GIOBERT®

FI-6I.P4
FOR: ZADI®

CL-2I
CL-2D
CL-3I
FOR: CLAUSOR®

F
01-78
FEM-1I
H
01-78
FEM-2I
E
01-78
FEM-1D
G
01-78
FEM-2D
FEM-3I
FEM-3D
FOR: FEMSA®

FOR: BASTA® -VIRO® -JML®

FOR: CAGIVA®

...
101-499
751-795
A00-A99
SUZU-13.P
SUZU-13D.P
FOR: SUZUKI®

...1-1625
...5001-6278
E...1-710
ZA-1
FOR: ZADI®
FOR: BRETER®

...1-1625
...5001-6278
E...1-710
ZA-1.P
FOR: ZADI®
FOR: BRETER®

...5001-6475
ZA-13.P
...1-700
...8001-9554
ZA-4D.P
...2001-3554
...8001-9554
ZA-2.P
FOR: ZADI®

ZA-8.P
FOR: ZADI®

Concerning the marks and commercial denominations see legal warning.
Concerniente a las marcas y denominaciones comerciales ver aviso legal.
Marka eta izendapen komertzialiei dagokienez, ikus lege-oharra.
Concernant les marques et denominations commerciales voir la note dans l'index.

FOR: CIMATTI®

2
100-309
FAB-1
FOR: FAAB®

1-1625
5001-6278
E...1-710
ZA-1
FOR: ZADI®
BRETER®

1-1625
5001-6278
E...1-710
ZA-1.P
FOR: ZADI®
BRETER®

FOR: DEMM®

.0.../...0...
...0.../...0
AA.../BA...
CA.../EA...
Z.../Z...
...Z.../...Z...
...Z.../...Z...
1 AL 5
NE-6
FOR: NEIMAN®

.0.../...0...
...0.../...0
AA.../BA...
CA.../EA...
Z.../Z...
...Z.../...Z...
...Z.../...Z...
1 AL 5
NE-6.P
FOR: NEIMAN®

FOR: DUCATI®

FOR:
AUTOBIANCHI®
CITROEN®
FERRARI®
FIAT®
LANCIA®
PEUGEOT®
YUGO ZASTAVA
CAGIVA®
DUCATI®
FANTIC MOTOR®
GARELLI®
GILERA®

K 3301-4886
K 7001-8092
T 5000-6027
T 7001-8092
S 0501-3278
H 7001-8092
FI-6I.P3
FOR: GIOBERT®

B. 1 AL 4
H. 1 AL 4
KAW-6.P
FOR: KAWASAKI®

KAW-6D.P
FOR: KAWASAKI®

1 AL 5
NE-6
FOR: NEIMAN®

.0.../...0...
...0.../...0
AA.../BA...
CA.../EA...
Z.../Z...
...Z.../...Z...
...Z.../...Z...
1 AL 5
NE-6.P
FOR: NEIMAN®

.0.../...0...
...0.../...0
AA.../BA...
CA...
1 AL 5
NE-8
FOR: NEIMAN®
CLAUSOR®

FOR: DERBY®

8001-9554
ZA-9.P1
FOR: ZADI®

FOR: DKM-HERCULES®

.0.../...0...
...0.../...0
AA.../BA...
CA.../EA...
Z.../Z...
...Z.../...Z...
...Z.../...Z...
1 AL 5
NE-6
FOR: NEIMAN®

.0.../...0...
...0.../...0
AA.../BA...
CA.../EA...
Z.../Z...
...Z.../...Z...
...Z.../...Z...
1 AL 5
NE-6.P
FOR: NEIMAN®

FOR: DUCATI®

K.3301-4886
K.7001-8092
T.5000-6027
T.7001-8092
S.0501-3278
H.7001-8092
K-H
7001-8092
AF-14.P
FOR: GIOBERT®
FIST® - M.MARELLI® - NEIMAN® - SIPEA®

FI-6I.P4
FOR: GIOBERT®

FOR: DUCATI®

1-1625
5001-6278
E...1-710
ZA-1
FOR: ZADI®
BRETER®

1-1625
5001-6278
E...1-710
ZA-1.P
FOR: ZADI®
BRETER®

5001-6475
1-700
8001-9554
ZA-4D.P
FOR: ZADI®
BASTA® - VIRO® - LML®

2001-3554
8001-9554
ZA-2.P
FOR: ZADI®
LML®

5001-6475
ZA-13.P
FOR: ZADI®
LML®

FOR: FANTIC MOTOR®

K.3301-4886
K.7001-8092
T.5000-6027
T.7001-8092
S.0501-3278
H.7001-8092
K-H
7001-8092
AF-14.P
FOR: GIOBERT®
FIST® - M.MARELLI® - NEIMAN® - SIPEA®

FI-6I.P4
FOR: GIOBERT®

FOR: DUCATI®

6
100-517
FAR-1
FOR: FARMA®
FISAM®

8
100-517
FAR-1D
FOR: FARMA®
FISAM®

2
100-517
FAR-2
FOR: FARMA®
FISAM®

4
100-517
FAR-2D
FOR: FARMA®
FISAM®

H
100-309
FAR-3
FOR: FARMA®
FISAM®

3
100-309
FAR-3D
FOR: FARMA®
FISAM®

4
100-309
FAR-4
FOR: FARMA®
FISAM®

F
01-78
FEM-1
FOR: FEMSA®

E
01-78
FEM-1D
FOR: FEMSA®

H
01-78
FEM-2
FOR: FEMSA®

G
01-78
FEM-2D
FOR: FEMSA®

H
01-78
FEM-3
FOR: FEMSA®

F
01-78
FEM-3D
FOR: FEMSA®

K 3301-4886
K 7001-8092
T 5000-6027
T 7001-8092
S 0501-3278
H 7001-8092
FI-6I
FOR: GIOBERT®

FOR:
ALFA ROMEO®
AUTOBIANCHI®
CITROEN®
FERRARI®
FIAT®
INNOCENTI®
LANCIA®
PEUGEOT®
YUGO ZASTAVA
CAGIVA®
DUCATI®
FANTIC MOTOR®
GARELLI®
GILERA®

K 3301-4886
K 7001-8092
T 5000-6027
T 7001-8092
S 0501-3278
H 7001-8092
FI-6I.P2
FOR: GIOBERT®

FERRARI®
FIAT®
CAGIVA®

FOR: FANTIC MOTOR®

FOR:
ALFA ROMEO®
AUTOBIANCHI®
CITROEN®
FERRARI®
FIAT®
INNOCENTI®
LANCIA®
PEUGEOT®
YUGO ZASTAVA
CAGIVA®
DUCATI®
FANTIC MOTOR®
GARELLI®
GILERA®

K 3301-4886
K 7001-8092
T 5000-6027
T 7001-8092
S 0501-3278
H 7001-8092
FI-6I
FOR: GIOBERT®

K 3301-4886
K 7001-8092
T 5000-6027
T 7001-8092
S 0501-3278
H 7001-8092
FI-6I.P2
FOR: GIOBERT®

FOR:
FERRARI®
FIAT®
CAGIVA®

FI-6I.P3
FOR: GIOBERT®

FOR:
AUTOBIANCHI®
CITROEN®
FERRARI®
FIAT®
LANCIA®
PEUGEOT®
YUGO ZASTAVA
CAGIVA®
DUCATI®
FANTIC MOTOR®
GARELLI®
GILERA®

3
0501-1000
IMS-3
FOR: SAFE®
CROMODORA® - FIST® - IMSA®

4
0501-1000
AF-21
FOR: SAFE®
CROMODORA® - FIST® - IMSA®

3
0501-1000
IMS-3.P
FOR: SAFE®
CROMODORA® - FIST® - IMSA®

4
0501-1000
AF-21.P
FOR: SAFE®
CROMODORA® - FIST® - IMSA®

1
0501-1000
IMS-5
FOR: SAFE®
CROMODORA® - FIST® - IMSA®

2
0501-1000
AF-19
FOR: SAFE®
CROMODORA® - FIST® - IMSA®

1
0501-1000
IMS-5.P
FOR: SAFE®
CROMODORA® - FIST® - IMSA®

2
0501-1000
AF-19.P
FOR: SAFE®
CROMODORA® - FIST® - IMSA®

IMS-13
FOR: SAFE®
CROMODORA® - FIST® - IMSA®

IMS-13.P
FOR: SAFE®
CROMODORA® - FIST® - IMSA®

Concerning the marks and commercial denominations see legal warning.
Concerniente a las marcas y denominaciones comerciales ver aviso legal.
Marka eta izendapen komertzialiez dagokienez, ikus lege-oharra.
Concernant les marques et dénominations commerciales voir la note dans l'index.

FOR: FANTIC MOTOR®

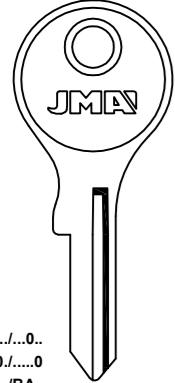
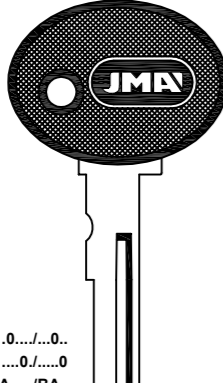
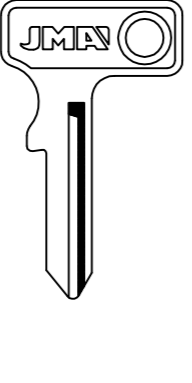
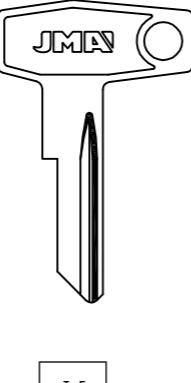
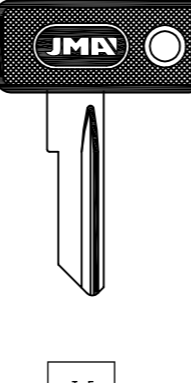
 .0.../...0... ...0/...0 AA.../BA... CA.../EA... Z.../Z... ...Z.../Z... ...Z.../Z... 1 AL 5 NE-6 FOR: NEIMAN®	 .0.../...0... ...0/...0 AA.../BA... CA.../EA... Z.../Z... ...Z.../Z... ...Z.../Z... 1 AL 5 NE-6.P FOR: NEIMAN®	 .0.../...0... ...0/...0 AA.../BA... CA.../EA... Z.../Z... ...Z.../Z... ...Z.../Z... 1 AL 5 NE-8 FOR: NEIMAN® FOR: CLAUSOR®	 .0.../...0... ...0/...0 AA.../BA... CA.../EA... Z.../Z... ...Z.../Z... ...Z.../Z... 1 AL 5 ZA-1 FOR: ZADI® FOR: BRETER®	 .0.../...0... ...0/...0 AA.../BA... CA.../EA... Z.../Z... ...Z.../Z... ...Z.../Z... 1 AL 5 ZA-1.P FOR: ZADI® FOR: BRETER®
---	---	--	--	---

FOR: GARELLI®

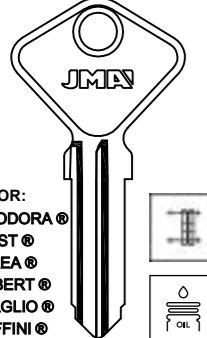
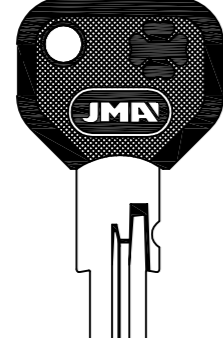
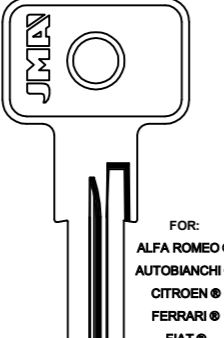
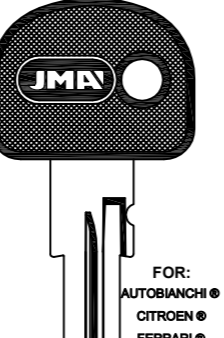
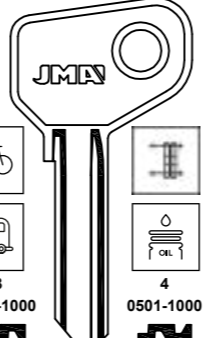
 FOR: CROMODORA® FIST® FREA® GIOBERT® MIRAGLIO® RUFFINI® 6 100-309 AF-5I 2 100-309 AF-6I FOR: SAFE®	 8 100-309 AF-5D 4 100-309 AF-6D FOR: SAFE®	 FOR: ALFA ROMEO® AUTOBIANCHI® CITROEN® FERRARI® FIAT® INNOCENTI® LANCIA® PEUGEOT® YUGO ZASTAVA® CAGIVA® DUCATI® FANTIC MOTOR® GARELLI® GILERA® K 3301-4886 K 7001-8092 T 5000-6027 T 7001-8092 S 0501-3278 H 7001-8092 AF-14.P FOR: GIOBERT® FOR: FIST®-M.MARELLI®-NEIMAN®-SIPEA®	 FOR: AUTOBIANCHI® CITROEN® FERRARI® FIAT® LANCIA® PEUGEOT® YUGO ZASTAVA® CAGIVA® DUCATI® FANTIC MOTOR® GARELLI® GILERA® K 3301-4886 K 7001-8092 T 5000-6027 T 7001-8092 S 0501-3278 H 7001-8092 FI-6I FOR: GIOBERT®	 3 0501-1000 IMS-3 1 0501-1000 IMS-5 4 0501-1000 AF-21 2 0501-1000 AF-19 4 100-309 IMS-13 FOR: SAFE® FOR: CROMODORA®-FIST®-JMSA®
---	--	---	---	--

FOR: GARELLI®

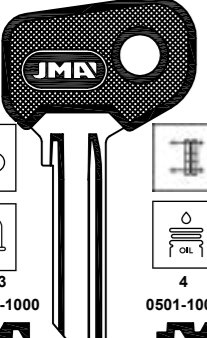
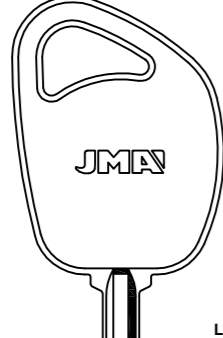
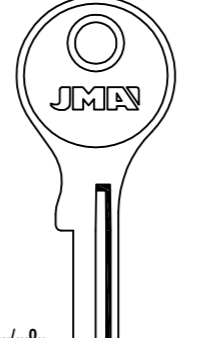
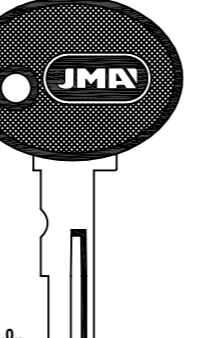
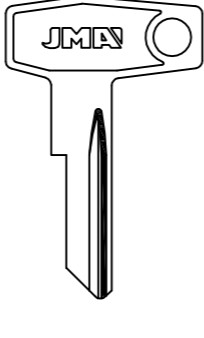
 3 0501-1000 IMS-3.P 1 0501-1000 IMS-5.P IMS-13.P FOR: SAFE® FOR: CROMODORA®-FIST®-JMSA®	 4 0501-1000 AF-21.P 2 0501-1000 AF-19.P JD-2 FOR: JOHN DEERE® FOR: DELTA®	 .0.../...0... ...0/...0 AA.../BA... CA.../EA... Z.../Z... ...Z.../Z... ...Z.../Z... 1 AL 5 NE-6 FOR: NEIMAN®	 .0.../...0... ...0/...0 AA.../BA... CA.../EA... Z.../Z... ...Z.../Z... ...Z.../Z... 1 AL 5 NE-6.P FOR: NEIMAN®	 .0.../...0... ...0/...0 AA.../BA... CA.../EA... Z.../Z... ...Z.../Z... ...Z.../Z... 1 AL 5 ZA-1 FOR: ZADI® FOR: BRETER®
---	---	---	--	---

FOR: GARELLI®

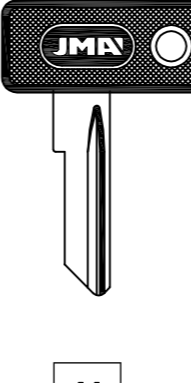
 .0.../...0... ...0/...0 AA.../BA... CA.../EA... Z.../Z... ...Z.../Z... ...Z.../Z... 1 AL 5 ZA-1.P FOR: ZADI® FOR: BRETER®

FOR: GILERA®

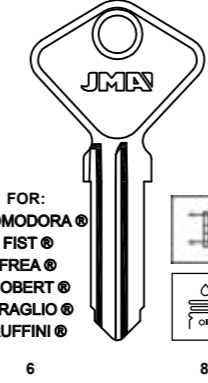
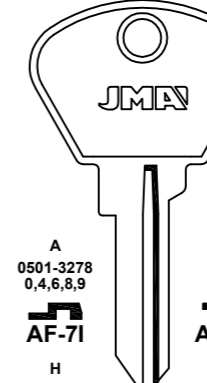
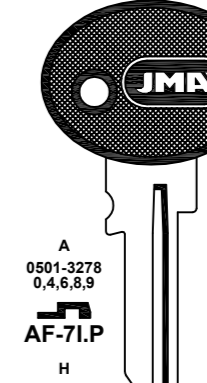
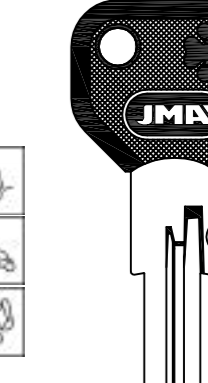
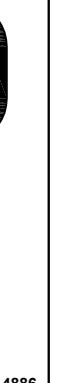
 FOR: CROMODORA® FIST® FREA® GIOBERT® MIRAGLIO® RUFFINI® 6 100-309 AF-5I 2 100-309 AF-6I FOR: SAFE®	 8 100-309 AF-5D 4 100-309 AF-6D FOR: SAFE®	 A 0501-3278 0,4,6,8,9 AF-7I H 01-78 AF-8I F 01-78 AF-9I FOR: SIPEA® FOR: SAFE®	 G 01-78 AF-8D E 01-78 AF-9D FOR: SIPEA® FOR: SAFE®	 A 0501-3278 0,4,6,8,9 AF-7I.P H 01-78 AF-8I.P F 01-78 AF-9I.P FOR: SIPEA® FOR: SAFE®	 G 01-78 AF-8D.P E 01-78 AF-9D.P FOR: SIPEA® FOR: SAFE®	 K-H 7001-8092 AF-14.P FOR: GIOBERT®	 K 3301-4886 K 7001-8092 T 5000-6027 T 7001-8092 S 0501-3278 H 7001-8092 FI-6I.P4 FOR: GIOBERT® FOR: MARELLI®-NEIMAN®-SIPEA®
--	---	---	--	---	--	--	---

FOR: GILERA®

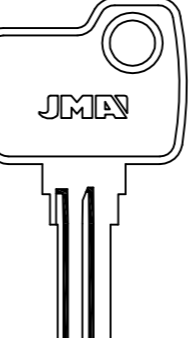
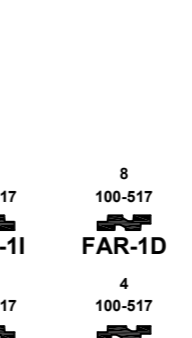
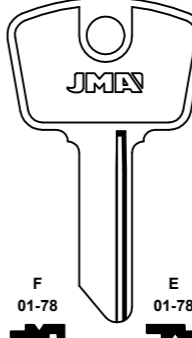
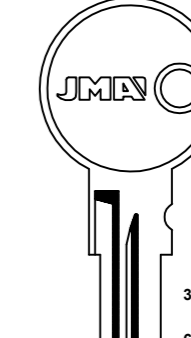
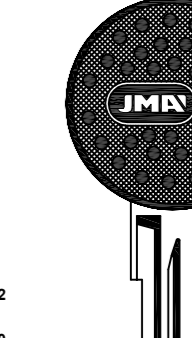
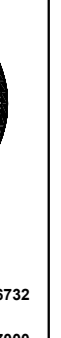
 6 100-517 FAR-1I 2 100-517 FAR-2I H 100-309 FAR-3 FOR: FARMA® FOR: FISAM®	 8 100-517 FAR-1D 4 100-517 FAR-2D H 100-309 FAR-3D FAR-4D	 F 01-78 FEM-1I H 01-78 FEM-2I FOR: FEMSA®	 E 01-78 FEM-1D G 01-78 FEM-2D FOR: FEMSA®	 J 3001-6732 N 6001-7000 FI-1 J 3001-6732 N 6001-7000 FI-10 FOR: GIOBERT®	 J 3001-6732 N 6001-7000 FI-1.P J 3001-6732 N 6001-7000 FI-10.P FOR: GIOBERT®
--	--	---	---	--	--

FOR: GILERA®

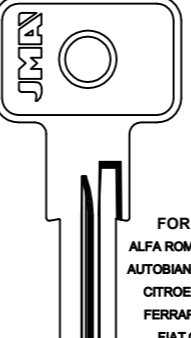
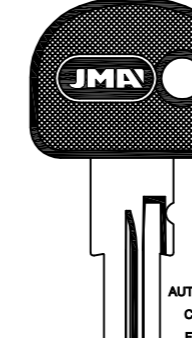
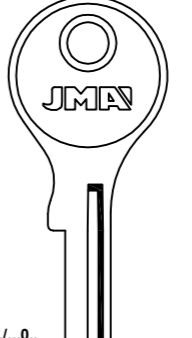
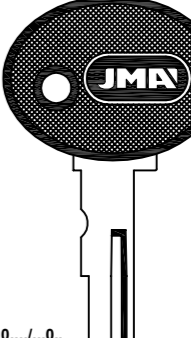
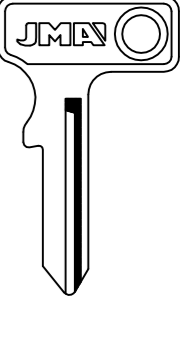
 FOR: ALFA ROMEO® AUTOBIANCHI® CITROEN® FERRARI® FIAT® INNOCENTI® LANCIA® PEUGEOT® YUGO ZASTAVA® CAGIVA® DUCATI® FANTIC MOTOR® GARELLI® GILERA® K 3301-4886 K 7001-8092 T 5000-6027 T 7001-8092 S 0501-3278 H 7001-8092 FI-6I FOR: GIOBERT®	 FOR: AUTOBIANCHI® CITROEN® FERRARI® FIAT® LANCIA® PEUGEOT® YUGO ZASTAVA® CAGIVA® DUCATI® FANTIC MOTOR® GARELLI® GILERA® K 3301-4886 K 7001-8092 T 5000-6027 T 7001-8092 S 0501-3278 H 7001-8092 FI-6I.P3 FOR: GIOBERT®	 .0.../...0... ...0/...0 AA.../BA... CA.../EA... Z.../Z... ...Z.../Z... ...Z.../Z... 1 AL 5 NE-6 FOR: NEIMAN®	 .0.../...0... ...0/...0 AA.../BA... CA.../EA... Z.../Z... ...Z.../Z... ...Z.../Z... 1 AL 5 NE-6.P FOR: NEIMAN®	 .0.../...0... ...0/...0 AA.../BA... CA.../EA... Z.../Z... ...Z.../Z... ...Z.../Z... 1 AL 5 NE-8 FOR: NEIMAN® FOR: CLAUSOR®
--	--	---	---	--

Concerning the marks and commercial denominations see legal warning.
 Concerniente a las marcas y denominaciones comerciales ver aviso legal.
 Marka eta izendapen komertzialiei dagokienez, ikus lege-oharra.
 Concernant les marques et denominations commerciales voir la note dans l'index.

FOR: GILERA®

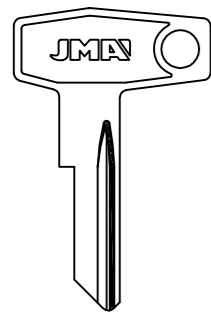

.....1-1625
.....5001-6278
E...1-710

FOR: ZADI®
FOR: BRETER®

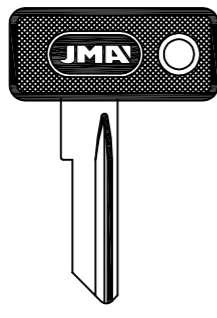

.....1-1625
.....5001-6278
E...1-710

FOR: ZADI®
FOR: BRETER®

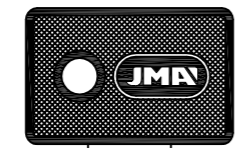

.....5001-6475
ZA-13.P
...1-700
.....8001-9554
ZA-4D.P
.....2001-3554
.....8001-9554
ZA-2.P

FOR: ZADI®
FOR: BASTA® -VIRO® -LML®



8001-9554
ZA-7D.P1
8001-9554
ZA-6D.P

FOR: ZADI®

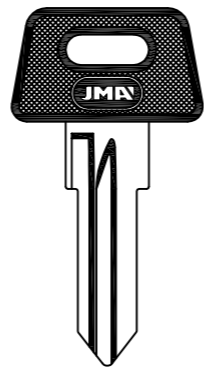

.....
8001-9554
ZA-7D.P1

FOR: ZADI®

FOR: HM®

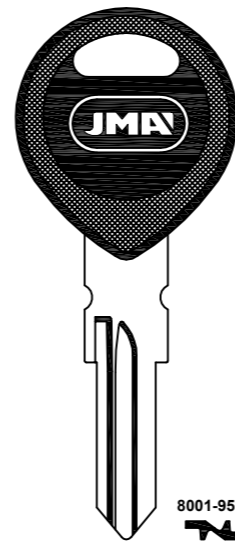

8001-9554
ZA-9.P1

FOR: ZADI®

FOR:
CROMODORA®
FIST®
FREA®
GIOBERT®
MIRAGLIO®
RUFFINI®



6
100-309
AF-5I
2
100-309
AF-6I

FOR: SAFE®



8
100-309
AF-5D
4
100-309
AF-6D

FOR: SAFE®

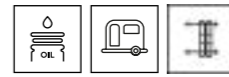
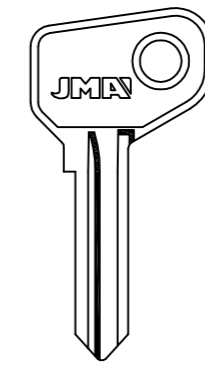

2
100-309
FAB-1

FOR: FAAB®

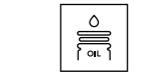
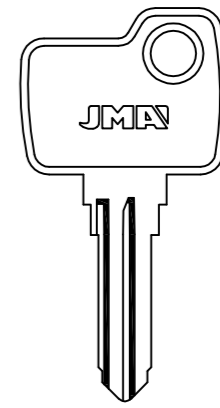

6
100-517
FAR-1I
2
100-517
FAR-2I
H
100-309
FAR-3

FOR: FARMA®
FOR: FISAM®

8
100-517
FAR-1D
4
100-517
FAR-2D
FAR-3D
FAR-4D

FOR: GILERA®

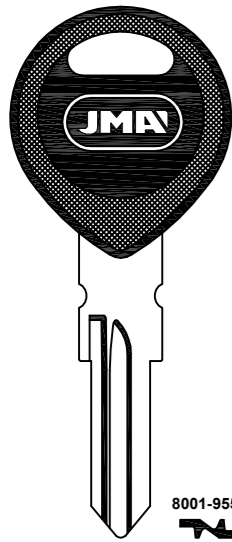

8001-9554
ZA-9.P1

FOR: ZADI®

FOR: HARLEY DAVIDSON®

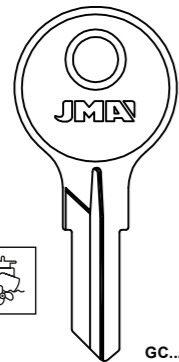

LAT.

A....250-1500
AP....250-1500
B....250-1500
C....1251-1700
CB....250-1500
DC-EP...250-699
P....250-1500

GC...
101-150
HC...
0-499
BS-4D

FOR: B & S®

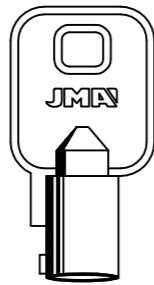

LAT.



CHI-1T

FOR: CHICAGO®

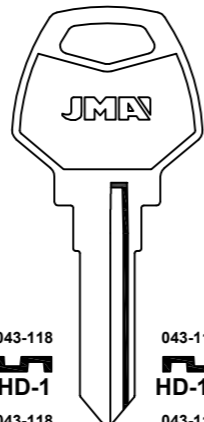

LAT.

043-118
HD-1

043-118
HD-2

043-118
HD-3

FOR: HARLEY DAVIDSON®



LAT.

043-118
HD-1D

043-118
HD-2D

043-118
HD-3D

FOR: HARLEY DAVIDSON®

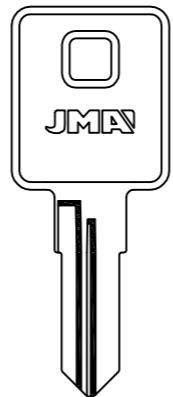

HD-4D

FOR: HARLEY DAVIDSON®

FOR: HONDA®

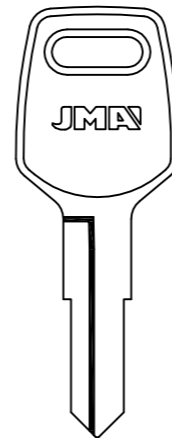

1 AL 4
HOND-3I HOND-3D

FOR: HONDA®

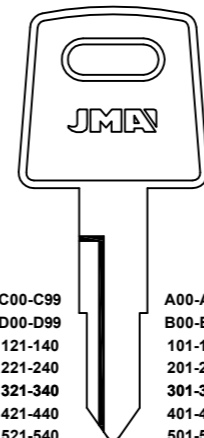

C00-C99
D00-D99
121-140
221-240
321-340
421-440
521-540
621-640
721-740
821-840

HOND-4I HOND-4D

FOR: HONDA®

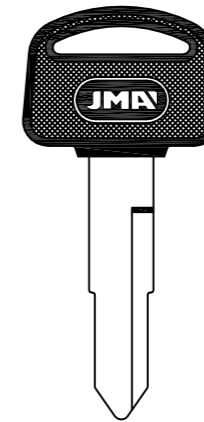

HOND-25.P2

FOR: HONDA®

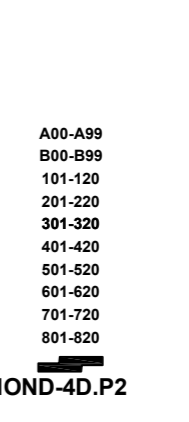

A00-A99
B00-B99
101-120
201-220
301-320
401-420
501-520
601-620
701-720
801-820

HOND-4D.P2

FOR: HONDA®

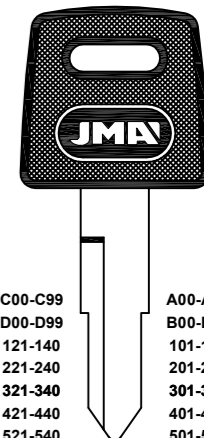

C00-C99
D00-D99
121-140
221-240
321-340
421-440
521-540
621-640
721-740
821-840

HOND-4I.P HOND-4D.P

FOR: HONDA®

FOR: HARLEY DAVIDSON®

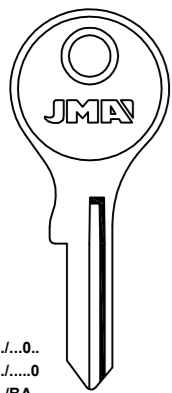

.0.../...0.
...0.../...0
AA.../BA...
CA.../EA...
Z.../Z...
...Z.../Z...
...Z.../Z...
1 AL 5
NE-6

FOR: NEIMAN®

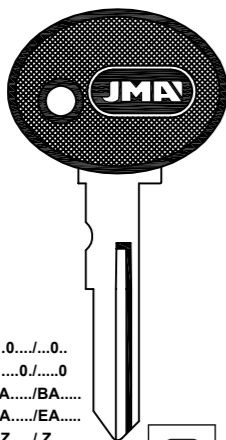

.0.../...0.
...0.../...0
AA.../BA...
CA.../EA...
Z.../Z...
...Z.../Z...
...Z.../Z...
1 AL 5
NE-6.P

FOR: NEIMAN®

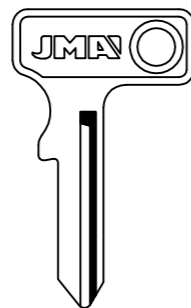

.0.../...0.
...0.../...0
AA.../BA...
CA...
1 AL 5
NE-8

FOR: NEIMAN®
FOR: CLAUSSOR®

FOR: HERCULES®

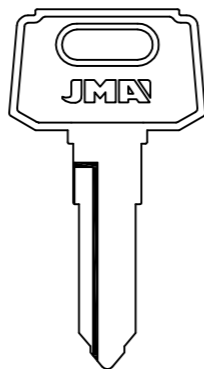

7001-8000
YAMA-21I

FOR: YAMAHA®

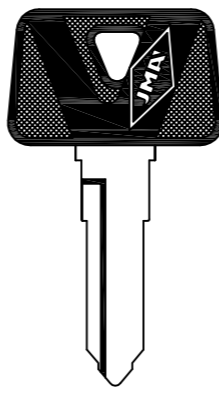

7001-7999
YAMA-21I.P

FOR: YAMAHA®

FOR: HONDA®



...C00-C99
...D00-D99
HOND-4I.P1

FOR: HONDA®



...A00-A99
...B00-B99
HOND-4D.P1

FOR: HONDA®

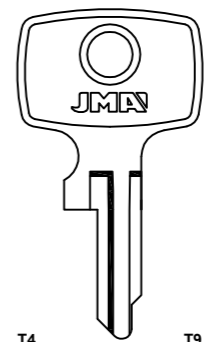

T4
HOND-5I
T1
HOND-6I
T3

FOR: HONDA®



T9
HOND-5D
T6
HOND-6D
T8

FOR: HONDA®

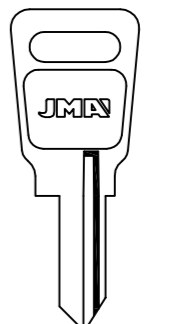

HOND-8I HOND-8D

FOR: HONDA®

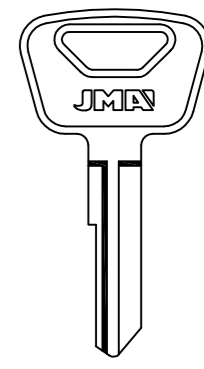

HOND-9I HOND-9D

FOR: HONDA®

Concerning the marks and commercial denominations see legal warning.
Concerniente a las marcas y denominaciones comerciales ver aviso legal.
Marka eta izendapen komertzialiei dagokienez, ikus lege-oharra.
Concernant les marques et denominations commerciales voir la note dans l'index.

JMA Opening the future

JMA Opening the future

Beziehen auf die marke und handelsname sehen sie die notiz im Impressum.
Relativamente às marcas e denominações comerciais, ver aviso legal.
Jeśli chodzi o znaki i nazwy handlowe, patrz Informacje prawne.

FOR: HONDA®

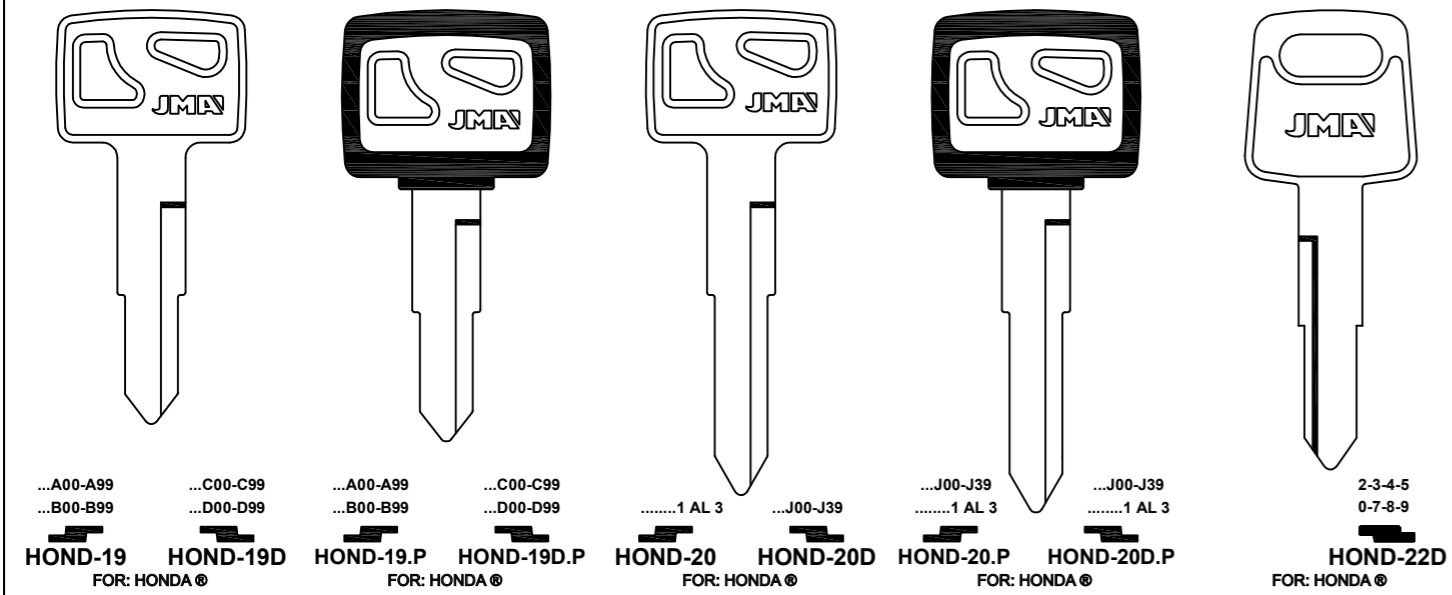

FOR: HONDA®

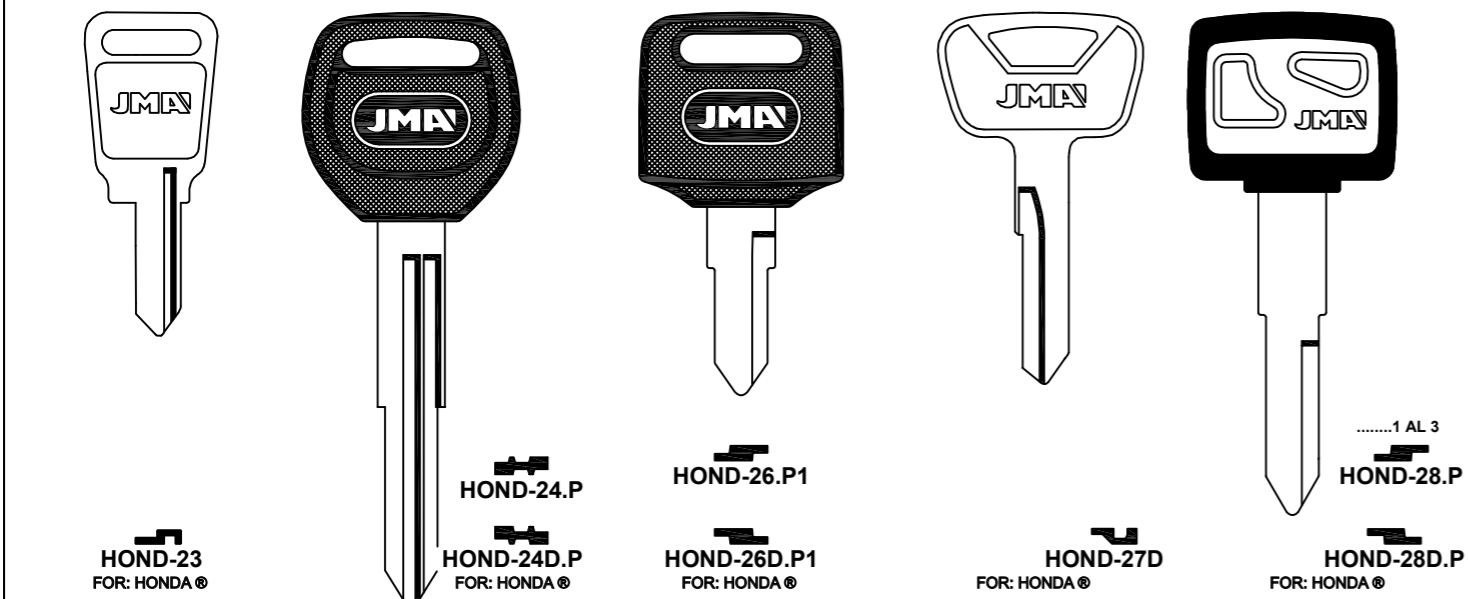

FOR: HONDA®

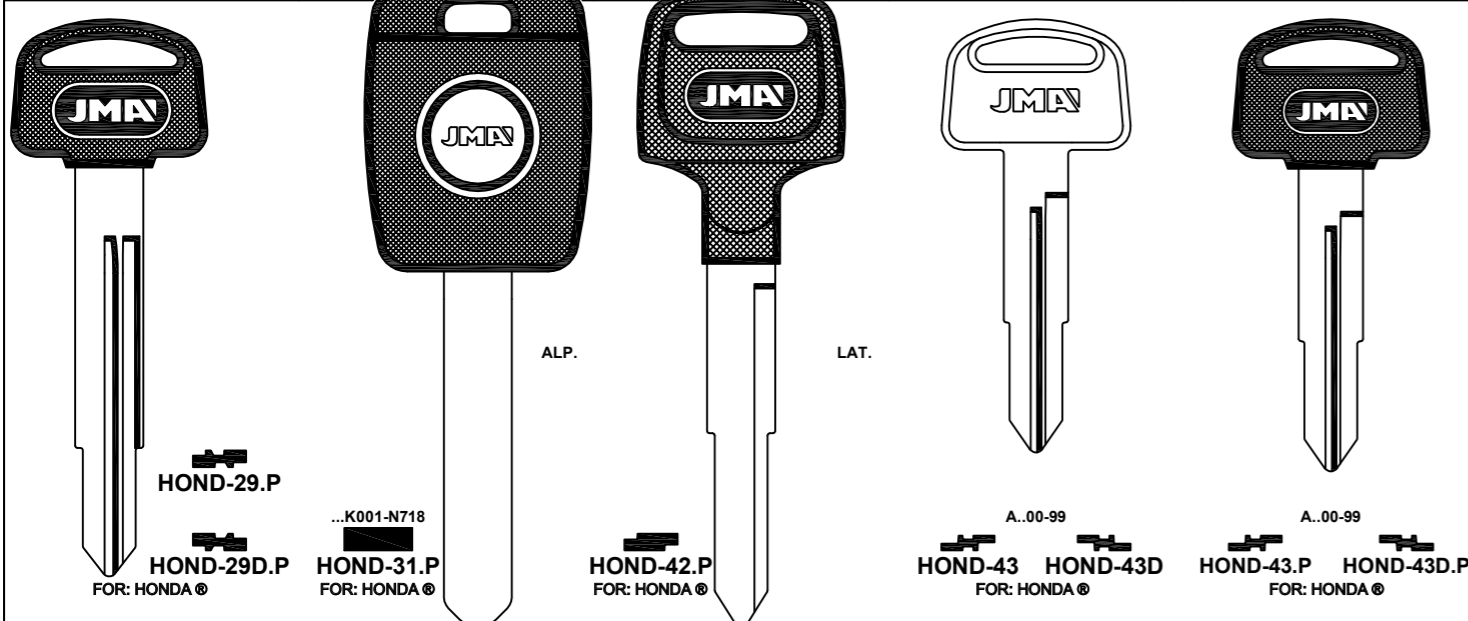

FOR: HONDA®

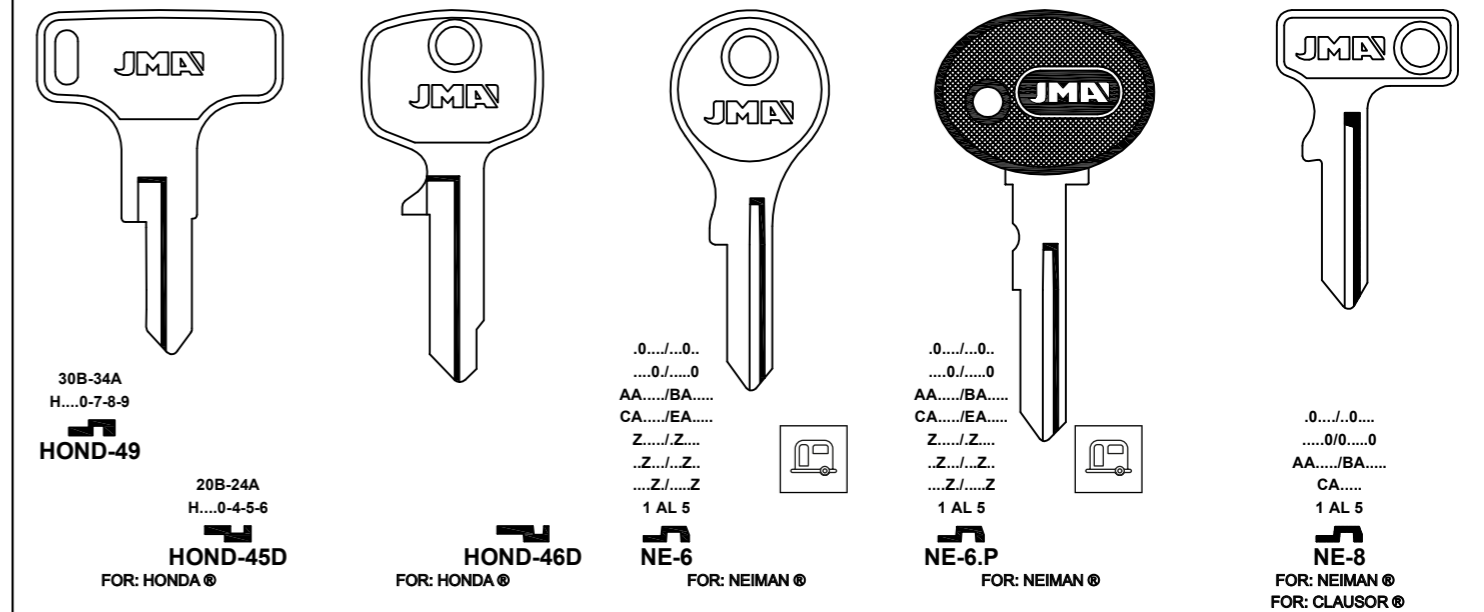

FOR: HONDA®

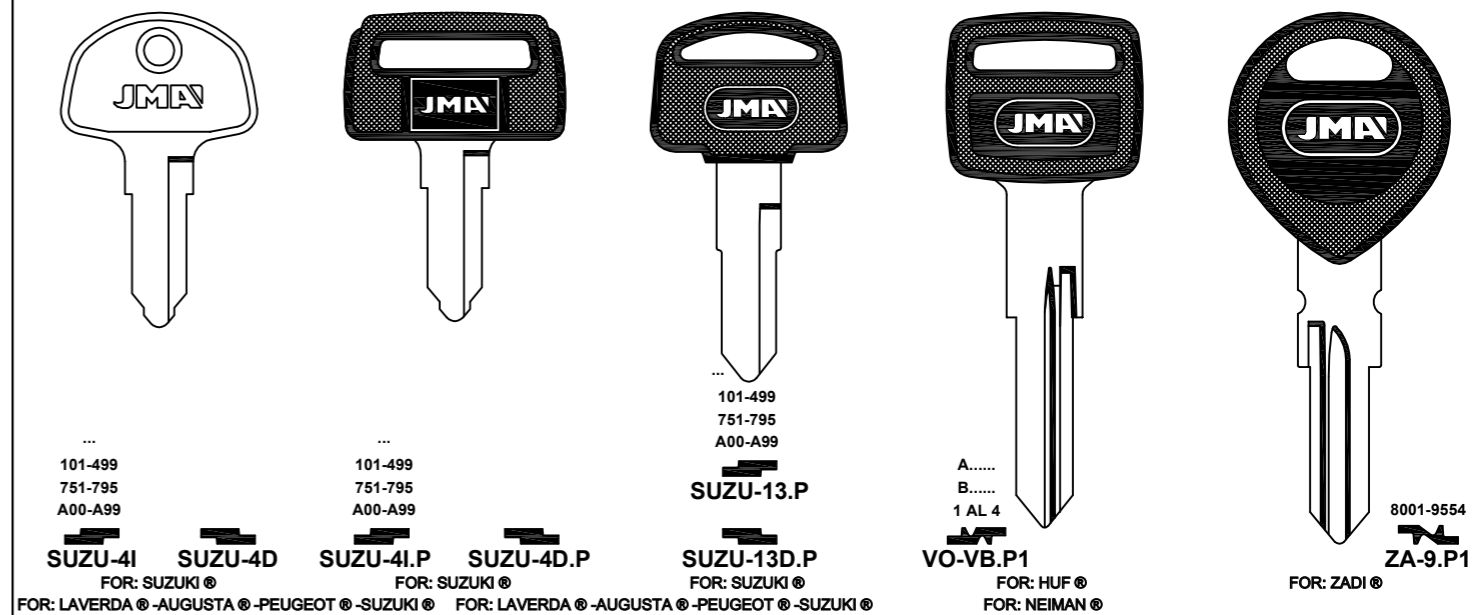

FOR: ITALJET®

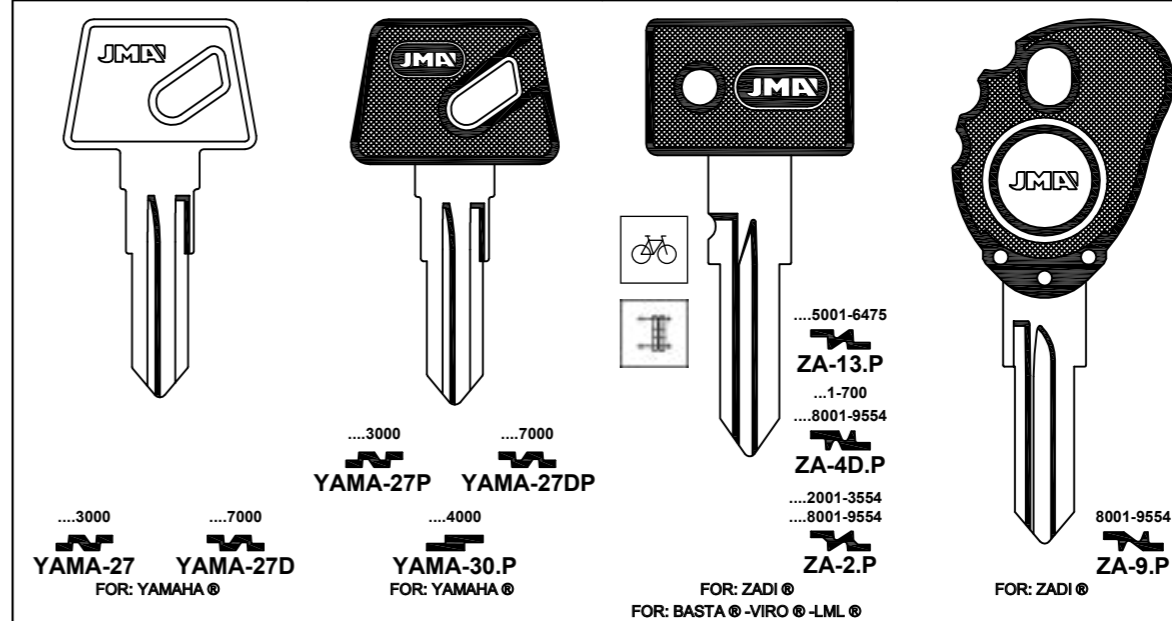

FOR: KAWASAKI®

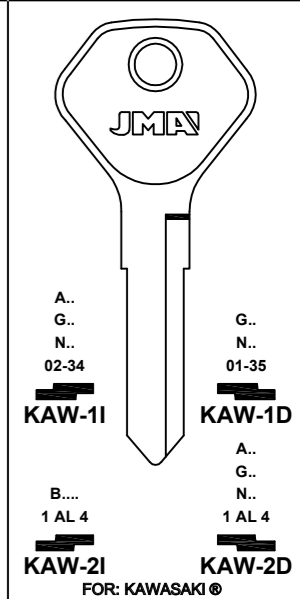

Concerning the marks and commercial denominations see legal warning.
Concerniente a las marcas y denominaciones comerciales ver aviso legal.
Marka eta izendapen komertzialiei dagokienez, ikus lege-oharra.
Concernant les marques et dénominations commerciales voir la note dans l'index.



FOR: KAWASAKI®

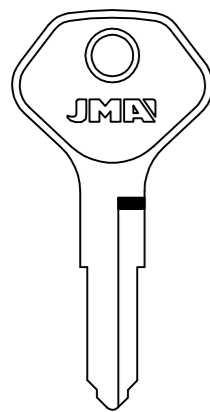

Z
5000-6000

KAW-3
FOR: KAWASAKI®

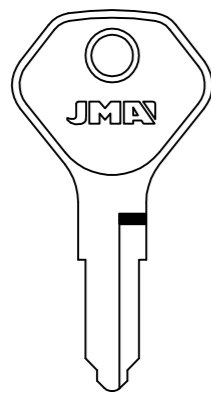

751-795
PLC
401-600

KAW-4
FOR: KAWASAKI®

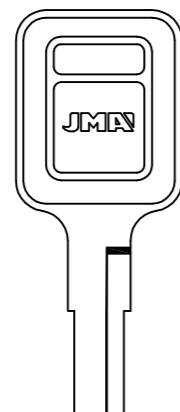

Z....
5000-6000

KAW-5
FOR: KAWASAKI®

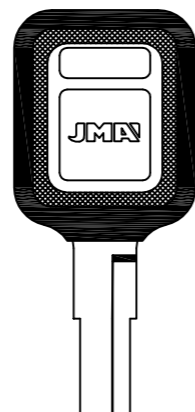

Z....
5000-6000

KAW-5.P
FOR: KAWASAKI®

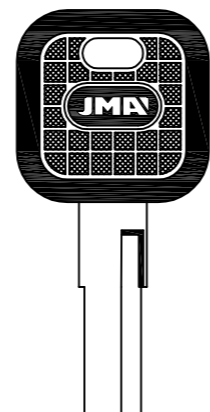

B.. 1 AL 4
H.. 1 AL 4

KAW-6.P KAW-6D.P
FOR: KAWASAKI®

FOR: KAWASAKI®

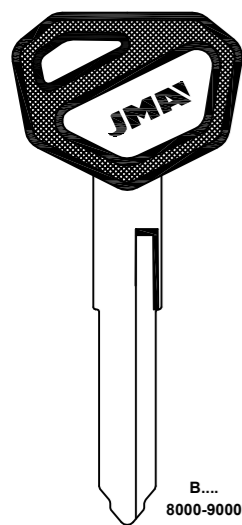

B....
8000-9000

KAW-7.P
FOR: KAWASAKI®

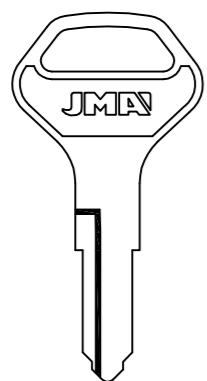

KAW-8D
FOR: KAWASAKI®

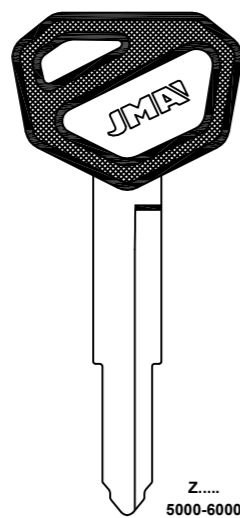

Z....
5000-6000

KAW-9.P
FOR: KAWASAKI®

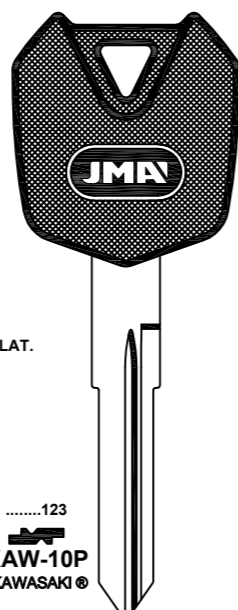

LAT.

.....123

KAW-10P
FOR: KAWASAKI®

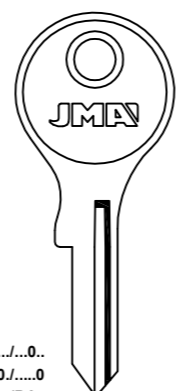

.0.../...0...
...0.../...0...
AA.../BA...
CA.../EA...
Z.../Z...
...Z.../Z...
...Z.../Z...
1 AL 5

NE-6
FOR: NEIMAN®

FOR: KAWASAKI®

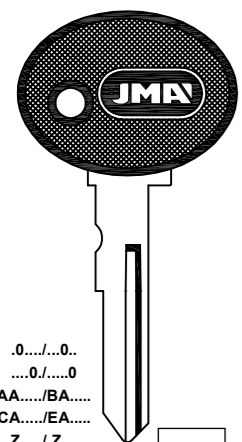

.0.../...0...
...0.../...0...
AA.../BA...
CA.../EA...
Z.../Z...
...Z.../Z...
1 AL 5

NE-6.P
FOR: NEIMAN®

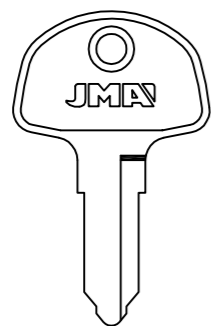

101-499
751-795
A00-A99

SUZU-4I SUZU-4D
FOR: SUZUKI®
FOR: LAVERDA® -AUGUSTA® -PEUGEOT® -SUZUKI®

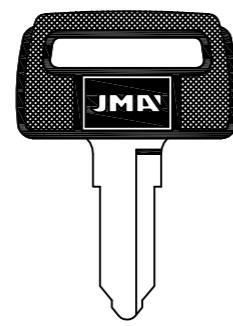

101-499
751-795
A00-A99

SUZU-4I.P SUZU-4D.P
FOR: SUZUKI®
FOR: LAVERDA® -AUGUSTA® -PEUGEOT® -SUZUKI®



6001-7000

SUZU-12.P SUZU-12D.P
FOR: SUZUKI®
FOR: LAVERDA® -AUGUSTA® -PEUGEOT® -SUZUKI®

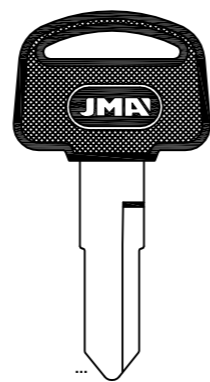

101-499
751-795
A00-A99

SUZU-13.P
FOR: SUZUKI®
FOR: LAVERDA® -AUGUSTA® -PEUGEOT® -SUZUKI®

FOR: KTM®

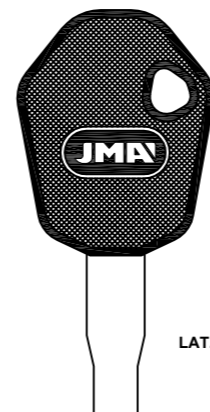

... 00001-03001
5.8
3
1

KM-1.P
FOR: KTM®



A....
B....
1 AL 4

VO-VB.P1
FOR: HUF®
FOR: NEIMAN®

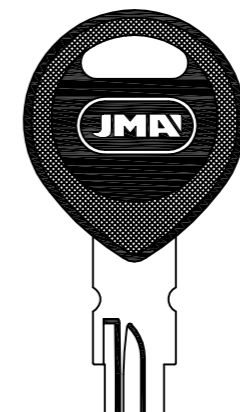

8001-9554

ZA-9.P1
FOR: ZADI®

FOR: KYMCO®

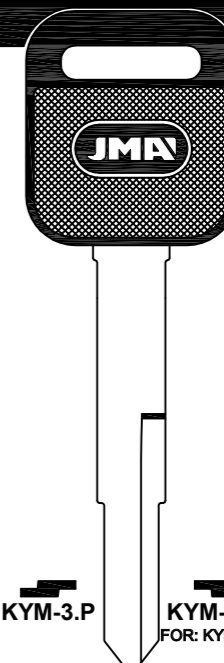

KYM-3.P
FOR: KYMCO®

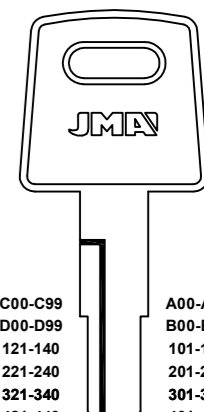

C00-C99
D00-D99
121-140
221-240
321-340
421-440
521-540
621-640
721-740
821-840

A00-A99
B00-B99
101-120
201-220
301-320
401-420
501-520
601-620
701-720
801-820

HOND-4I HOND-4D
FOR: HONDA®

FOR: KYMCO®

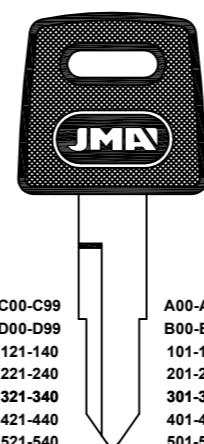

C00-C99
D00-D99
121-140
221-240
321-340
421-440
521-540
621-640
721-740
821-840

HOND-4I.P HOND-4D.P
FOR: HONDA®



KYM-1.P KYM-1D.P
FOR: KYMCO®

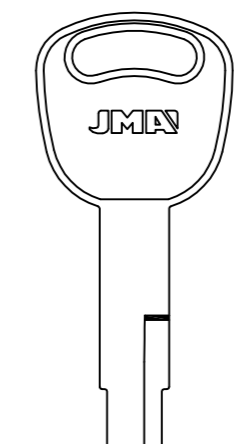

KYM-2 KYM-2D
FOR: KYMCO®

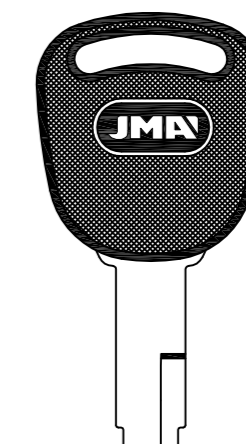

KYM-2.P KYM-2D.P
FOR: KYMCO®

FOR: LAMBRETTA®

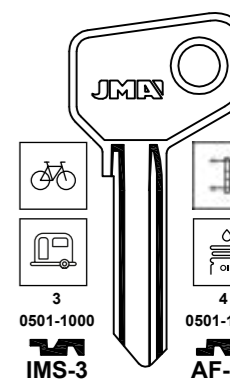

3
0501-1000
IMS-3

4
0501-1000
AF-21

1
0501-1000
IMS-5

2
0501-1000
AF-19

IMS-13
FOR: SAFE®
FOR: CROMODORA® -FIST® -IMSA®

FOR: LAMBRETTA®

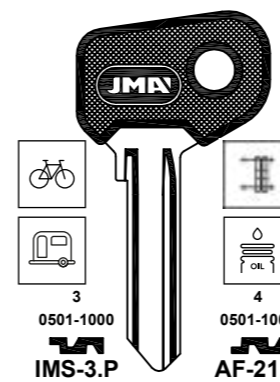

3
0501-1000
IMS-3.P

4
0501-1000
AF-21.P

1
0501-1000
IMS-5.P

2
0501-1000
AF-19.P

IMS-13.P
FOR: SAFE®
FOR: CROMODORA® -FIST® -IMSA®

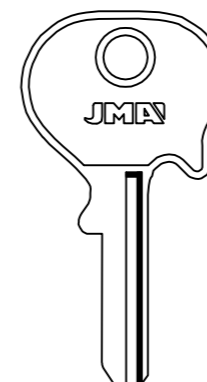

1 AL 5

NE-56
FOR: NEIMAN®

FOR: LAVERDA®

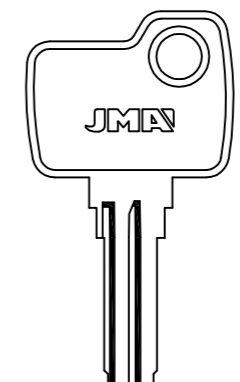

6
100-517
FAR-1I

8
100-517
FAR-1D

2
100-517
FAR-2I

4
100-517
FAR-2D

H
100-309
FAR-3

FAR-3D

FAR-4D
FOR: FARMA®
FOR: FISAM®

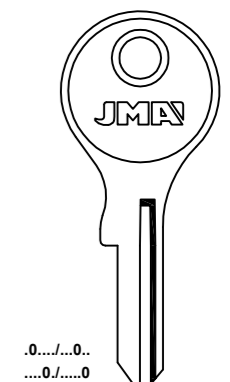

.0.../...0...
...0.../...0...
AA.../BA...
CA.../EA...
Z.../Z...
...Z.../Z...
1 AL 5

NE-6
FOR: NEIMAN®

Concerning the marks and commercial denominations see legal warning.
Concerniente a las marcas y denominaciones comerciales ver aviso legal.
Marka eta izendapen komertzialiei dagokienez, ikus lege-oharra.
Concernant les marques et denominations commerciales voir la note dans l'index.

JMA® Opening the future

JMA® Opening the future

Beziehen auf die Marke und Handelsname sehen sie die Notiz im Impressum.
Relativamente às marcas e denominações comerciais, ver aviso legal.
Jeśli chodzi o znaki i nazwy handlowe, patrz Informacje prawne.

K04 / 331

FOR: LAVERDA®

.0.../...0...
 ...0.../...0...
 AA.../BA...
 CA.../EA...
 Z.../Z...
 ...Z.../...Z...
 ...Z.../...Z...
 1 AL 5
NE-6.P
 FOR: NEIMAN®

.0.../...0...
 ...0.../...0...
 AA.../BA...
 CA...
 1 AL 5
NE-8
 FOR: NEIMAN®
 FOR: CLAUSOR®

...
 101-499
 751-795
 A00-A99
SUZU-4I SUZU-4D
 FOR: SUZUKI®
 FOR: LAVERDA® -AUGUSTA® -PEUGEOT® -SUZUKI®

...
 101-499
 751-795
 A00-A99
SUZU-4I.P SUZU-4D.P
 FOR: SUZUKI®
 FOR: LAVERDA® -AUGUSTA® -PEUGEOT® -SUZUKI®

...
 101-499
 751-795
 A00-A99
SUZU-13.P
SUZU-13D.P
 FOR: SUZUKI®
 FOR: SUZUKI®

FOR: MAICO®

.0.../...0...
 ...0.../...0...
 AA.../BA...
 CA...
 1 AL 5
NE-8
 FOR: NEIMAN®
 FOR: CLAUSOR®

FOR: MALAGUTI®

...3000
YAMA-27 YAMA-27P
 FOR: YAMAHA®

...7000
YAMA-27DP
 FOR: YAMAHA®

...4000
YAMA-30.P
 FOR: YAMAHA®

...1-1625
 ...5001-6278
 E...1-710
ZA-1
 FOR: ZADI®
 FOR: BRETER®

...1-1625
 ...5001-6278
 E...1-710
ZA-1.P
 FOR: ZADI®
 FOR: BRETER®

FOR: LAVERDA®

...1-1625
 ...5001-6278
 E...1-710
ZA-1
 FOR: ZADI®
 FOR: BRETER®

...1-1625
 ...5001-6278
 E...1-710
ZA-1.P
 FOR: ZADI®
 FOR: BRETER®

ZA-8.P
 FOR: ZADI®

FOR: LINCE®

FOR:
 CROMODORA®
 FIST®
 FREA®
 GIOBERT®
 MIRAGLIO®
 RUFFINI®

6
 100-309
AF-5I

8
 100-309
AF-5D

2
 100-309
AF-6I

4
 100-309
AF-6D

CL-2I CL-2D
 FOR: CLAUSOR®

FOR: MALAGUTI®

...5001-6475
ZA-13.P
 ...1-700
 ...8001-9554
ZA-4D.P
 ...2001-3554
 ...8001-9554
ZA-2.P

8001-9554
ZA-9.P2
 8001-9554
ZA-6D.P1

8001-9554
ZA-9.P

...5001-6475
ZA-13.P
 FOR: ZADI®
 FOR: LML®

FOR: MALANCA®

...1-1625
 ...5001-6278
 E...1-710
ZA-1
 FOR: ZADI®
 FOR: BRETER®

FOR: LINCE®

CL-3I
 FOR: CLAUSOR®

FOR: MAICO®

CL-2I CL-2D
 FOR: CLAUSOR®

CL-3I
 FOR: CLAUSOR®

.0.../...0...
 ...0.../...0...
 AA.../BA...
 CA.../EA...
 Z.../Z...
 ...Z.../...Z...
 ...Z.../...Z...
 1 AL 5
NE-6
 FOR: NEIMAN®

.0.../...0...
 ...0.../...0...
 AA.../BA...
 CA.../EA...
 Z.../Z...
 ...Z.../...Z...
 ...Z.../...Z...
 1 AL 5
NE-6.P
 FOR: NEIMAN®

FOR: MALANCA®

...1-1625
 ...5001-6278
 E...1-710
ZA-1.P
 FOR: ZADI®
 FOR: BRETER®

FOR: MBK®

...3000
YAMA-27 YAMA-27P
 FOR: YAMAHA®

...7000
YAMA-27DP
 FOR: YAMAHA®

...4000
YAMA-30.P
 FOR: YAMAHA®

...5001-6475
ZA-13.P
 ...1-700
 ...8001-9554
ZA-4D.P
 ...2001-3554
 ...8001-9554
ZA-2.P

8001-9554
ZA-9.P2
 8001-9554
ZA-6D.P1

8001-9554
ZA-9.P

...5001-6475
ZA-13.P
 FOR: ZADI®
 FOR: LML®

Concerning the marks and commercial denominations see legal warning.
 Concerniente a las marcas y denominaciones comerciales ver aviso legal.
 Marka eta izendapen komertzialiei dagokienez, ikus lege-oharra.
 Concernant les marques et denominations commerciales voir la note dans l'index.

JMA Opening the future

JMA Opening the future

Beziehen auf die marke und handelsname sehen sie die notiz im Impressum.
 Relativamente às marcas e denominações comerciais, ver aviso legal.
 Jeśli chodzi o znaki i nazwy handlowe, patrz Informacje prawne.

FOR: MBK®

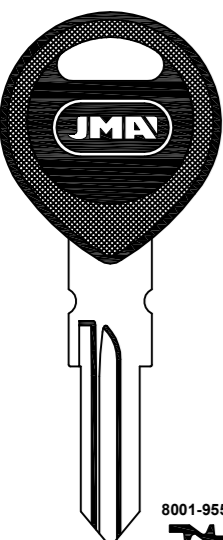

8001-9554
ZA-9.P1
FOR: ZADI®

FOR: MBM®

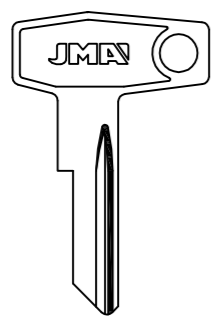

.....1-1625
.....5001-6278
E...1-710
ZA-1
FOR: ZADI®
FOR: BRETER®

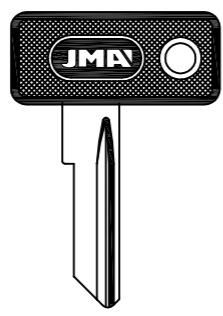

.....1-1625
.....5001-6278
E...1-710
ZA-1.P
FOR: ZADI®
FOR: BRETER®

FOR: MONTESA®

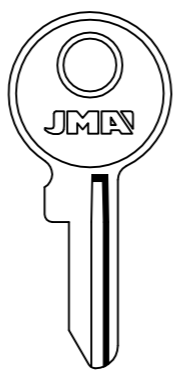

CL-21 CL-2D
FOR: CLAUSOR®

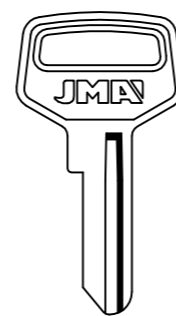

CL-31
FOR: CLAUSOR®

FOR: MOTO GUZZI®

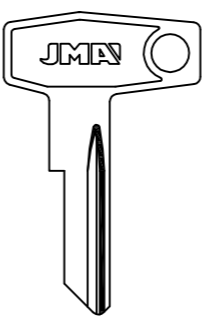

.....1-1625
.....5001-6278
E...1-710
ZA-1
FOR: ZADI®
FOR: BRETER®

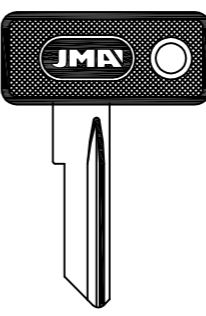

.....1-1625
.....5001-6278
E...1-710
ZA-1.P
FOR: ZADI®
FOR: BRETER®

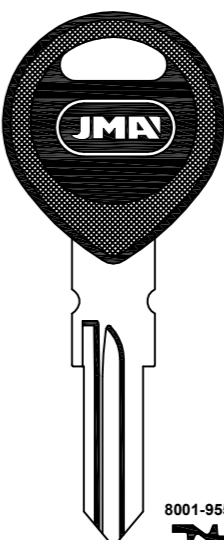

8001-9554
ZA-9.P1
FOR: ZADI®

FOR: MOTO MORINI®

FOR: CROMODORA®
FIST®
FREA®
GIOBERT®
MIRAGLIO®
RUFFINI®

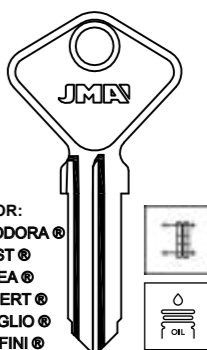

6
100-309
AF-5I

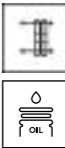

8
100-309
AF-5D

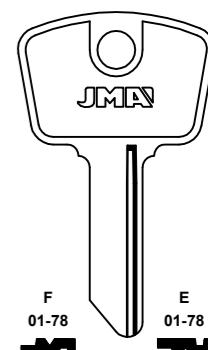

F 01-78
FEM-1I

E 01-78
FEM-1D

H 01-78
FEM-2I

G 01-78
FEM-2D

2
100-309
AF-6I

4
100-309
AF-6D

FEM-3I FEM-3D
FOR: FEMSA®

FOR: SAFE®

FOR: MORINI FRANCO®

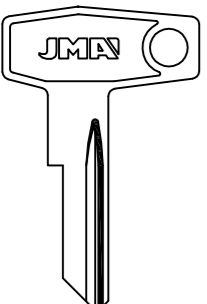

.....1-1625
.....5001-6278
E...1-710
ZA-1
FOR: ZADI®
FOR: BRETER®

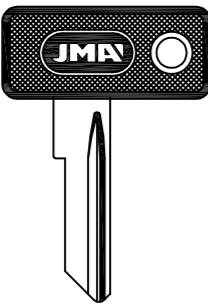

.....1-1625
.....5001-6278
E...1-710
ZA-1.P
FOR: ZADI®
FOR: BRETER®

FOR: MOTO GUZZI®

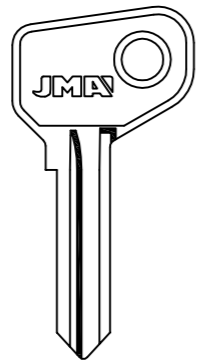

2
100-309
FAB-1
FOR: FAAB®

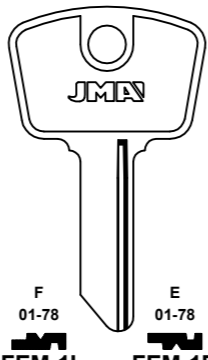

F 01-78
FEM-1I

E 01-78
FEM-1D

H 01-78
FEM-2I

G 01-78
FEM-2D

FEM-3I FEM-3D
FOR: FEMSA®

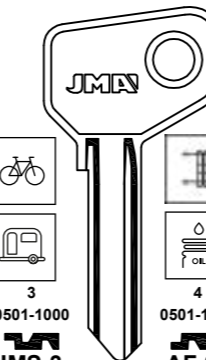

3 0501-1000
IMS-3

4 0501-1000
AF-21

1 0501-1000
IMS-5

2 0501-1000
AF-19

IMS-13
FOR: SAFE®
FOR: CROMODORA® -FIST® -IMSA®

FOR: MOTO MORINI®

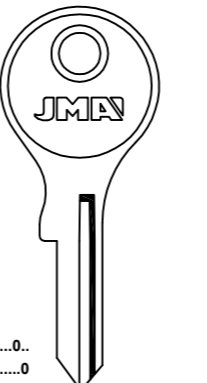

.0.../...0.
...0.../...0
AA.../BA...
CA.../EA...
Z.../Z...
...Z.../Z...
...Z.../Z...
1 AL 5
NE-6
FOR: NEIMAN®

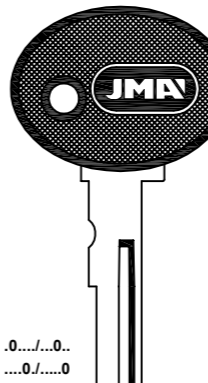

.0.../...0.
...0.../...0
AA.../BA...
CA.../EA...
Z.../Z...
...Z.../Z...
...Z.../Z...
1 AL 5
NE-6.P
FOR: NEIMAN®

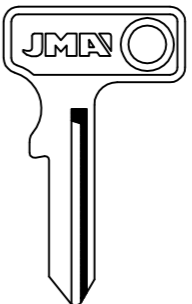

.0.../...0...
...0/0.../...0
AA.../BA...
CA...
1 AL 5
NE-8
FOR: NEIMAN®
FOR: CLAUSOR®

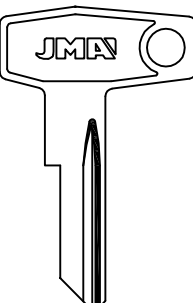

.....1-1625
.....5001-6278
E...1-710
ZA-1
FOR: ZADI®
FOR: BRETER®

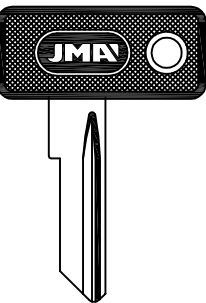

.....1-1625
.....5001-6278
E...1-710
ZA-1.P
FOR: ZADI®
FOR: BRETER®

FOR: MOTO GUZZI®

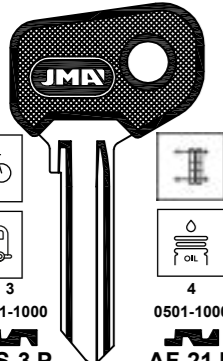

3 0501-1000
IMS-3.P

4 0501-1000
AF-21.P

1 0501-1000
IMS-5.P

2 0501-1000
AF-19.P

IMS-13.P
FOR: SAFE®
FOR: CROMODORA® -FIST® -IMSA®

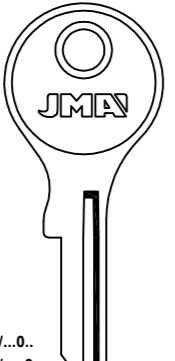

.0.../...0.
...0.../...0
AA.../BA...
CA.../EA...
Z.../Z...
...Z.../Z...
...Z.../Z...
1 AL 5
NE-6
FOR: NEIMAN®

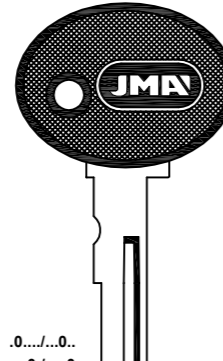

.0.../...0.
...0.../...0
AA.../BA...
CA.../EA...
Z.../Z...
...Z.../Z...
...Z.../Z...
1 AL 5
NE-6.P
FOR: NEIMAN®

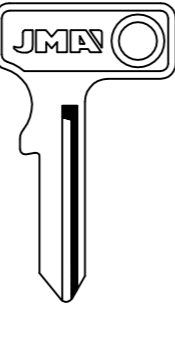

.0.../...0...
...0/0.../...0
AA.../BA...
CA...
1 AL 5
NE-8
FOR: NEIMAN®

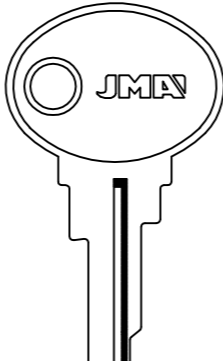

B...501-3278
B...0-4-6-8-9
SIP-3
FOR: SIPEA®
FOR: ARTEB® -CLAUSOR® -NEIMAN®

FOR: MOTOBECANE®

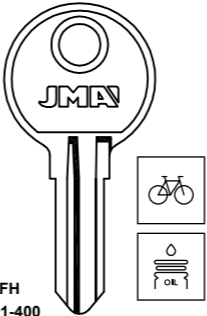

FH 001-400
501-550
LAS-3

H LAS-5

U LAS-U

E LAS-5D

X LAS-X

NE-6
FOR: NEIMAN®

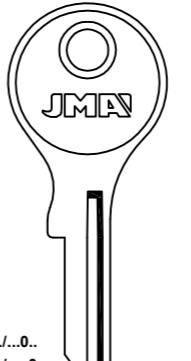

.0.../...0.
...0.../...0
AA.../BA...
CA.../EA...
Z.../Z...
...Z.../Z...
...Z.../Z...
1 AL 5
NE-6
FOR: NEIMAN®

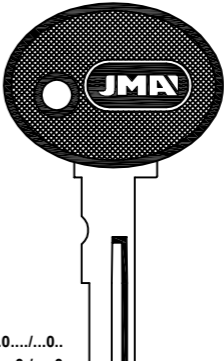

.0.../...0.
...0.../...0
AA.../BA...
CA.../EA...
Z.../Z...
...Z.../Z...
...Z.../Z...
1 AL 5
NE-6.P
FOR: NEIMAN®

FOR: MOTOBICI®

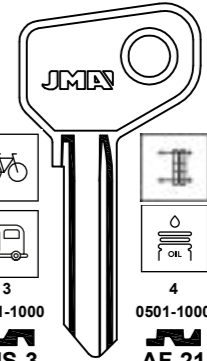

3 0501-1000
IMS-3

4 0501-1000
AF-21

1 0501-1000
IMS-5

2 0501-1000
AF-19

IMS-13
FOR: SAFE®
FOR: CROMODORA® -FIST® -IMSA®

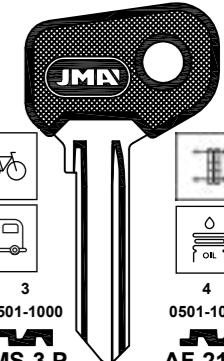

3 0501-1000
IMS-3.P

4 0501-1000
AF-21.P

1 0501-1000
IMS-5.P

2 0501-1000
AF-19.P

IMS-13.P
FOR: SAFE®
FOR: CROMODORA® -FIST® -IMSA®

Concerning the marks and commercial denominations see legal warning.
Concieniente a las marcas y denominaciones comerciales ver aviso legal.
Marka eta izendapen komertzialiei dagokienez, ikus lege-oharra.
Concernant les marques et denominations commerciales voir la note dans l'index.

JMA Opening the future

JMA Opening the future

Beziehen auf die marke und handelsname sehen sie die notiz im Impressum.
Relativamente às marcas e denominações comerciais, ver aviso legal.
Jeśli chodzi o znaki i nazwy handlowe, patrz Informacje prawne.

FOR: MOTABI®

...0.../...0...
...0/0...0
AA.../BA...
CA...
1 AL 5
NE-8
FOR: NEIMAN®
FOR: CLAUSOR®

FOR: MOTRON®

...1-1625
...5001-6278
E...1-710
ZA-1
FOR: ZADI®
FOR: BRETER®

...1-1625
...5001-6278
E...1-710
ZA-1.P
FOR: ZADI®
FOR: BRETER®

FOR: MV AUGUSTA®

A
0501-3278
0,4,6,8,9
AF-7I
H
01-78
AF-8I
F
01-78
AF-9I
FOR: SIPEA®
FOR: SAFE®

A
0501-3278
0,4,6,8,9
AF-7D
G
01-78
AF-8D
E
01-78
AF-9D
FOR: SIPEA®
FOR: SAFE®

A
0501-3278
0,4,6,8,9
AF-7I.P
H
01-78
AF-8I.P
F
01-78
AF-9I.P
FOR: SIPEA®
FOR: SAFE®

A
0501-3278
0,4,6,8,9
AF-7D.P
G
01-78
AF-8D.P
E
01-78
AF-9D.P
FOR: SIPEA®
FOR: SAFE®

FOR: NORTON®

NRA
FFE...1-100
FJA...1-100
FL...251-500
NRA...51-90
YFB...1-75
FMD...1-75
FG...1-30
NF...1-30
EJR...1-75
UN-FFE
MC...1-40
MRA...251-290
MRN...1-54
MRN...201-250
MRN...251-300
UN-MRN
FS...1-99
FS...876-955
UN-1FS
FA...
501-625
UN-44
FOR: UNION®

FP...
626-750
UN-FP
HX...100
UN-2
RM...
911-952
UN-44D
FR...
751-875
UN-FR
NGN...1-54
UN-NG
FOR: UNION®

FK...
01-99
876-955
UN-FK
FOR: UNION®

FS...
01-99
876-955
UN-FS
FOR: UNION®

FOR: OMC®

...1-1625
...5001-6278
E...1-710
ZA-1
FOR: ZADI®
FOR: BRETER®

...1-1625
...5001-6278
E...1-710
ZA-1.P
FOR: ZADI®
FOR: BRETER®

FOR: MV AUGUSTA®

6
100-517
FAR-1I
2
100-517
FAR-2I
H
100-309
FAR-3
FOR: FARMA®
FOR: FISAM®

8
100-517
FAR-1D
4
100-517
FAR-2D
FAR-3D
FAR-4D

F
01-78
FEM-1I
H
01-78
FEM-2I
FEM-3I

E
01-78
FEM-1D
G
01-78
FEM-2D
FEM-3D

...0.../...0...
...0/0...0
AA.../BA...
CA.../EA...
Z.../Z...
...Z.../Z...
...Z.../Z...
1 AL 5
NE-6
FOR: NEIMAN®

...0.../...0...
...0/0...0
AA.../BA...
CA.../EA...
Z.../Z...
...Z.../Z...
...Z.../Z...
1 AL 5
NE-6.P
FOR: NEIMAN®

FOR: OSSA®

CAS-1D
FOR: CASELLAS®

CL-2I
FOR: CLAUSOR®

CL-2D
FOR: CLAUSOR®

CL-3I
FOR: CLAUSOR®

...0.../...0...
...0/0...0
AA.../BA...
CA.../EA...
Z.../Z...
...Z.../Z...
...Z.../Z...
1 AL 5
NE-6
FOR: NEIMAN®

...0.../...0...
...0/0...0
AA.../BA...
CA.../EA...
Z.../Z...
...Z.../Z...
...Z.../Z...
1 AL 5
NE-6.P
FOR: NEIMAN®

FOR: MV AUGUSTA®

...
101-499
751-795
A00-A99
SUZU-4I
FOR: SUZUKI®

...
101-499
751-795
A00-A99
SUZU-4I.P
FOR: SUZUKI®

...
101-499
751-795
A00-A99
SUZU-4D
FOR: LAVERDA® -AUGUSTA® -PEUGEOT® -SUZUKI®

...
101-499
751-795
A00-A99
SUZU-4D.P
FOR: SUZUKI®

...
101-499
751-795
A00-A99
SUZU-13D
FOR: SUZUKI®

...
101-499
751-795
A00-A99
SUZU-13D.P
FOR: SUZUKI®

FOR: MZ®

...5001-6475
ZA-13.P
...1-700
...8001-9554
ZA-4D.P
...2001-3554
...8001-9554
ZA-2.P
FOR: ZADI®
FOR: BASTA® -VIRO® -LML®

FOR: PERIPOLI®

...1-1625
...5001-6278
E...1-710
ZA-1
FOR: ZADI®
FOR: BRETER®

...1-1625
...5001-6278
E...1-710
ZA-1.P
FOR: ZADI®
FOR: BRETER®

FOR: PEUGEOT®

...
101-499
751-795
A00-A99
SUZU-4I
FOR: SUZUKI®

...
101-499
751-795
A00-A99
SUZU-4D
FOR: SUZUKI®

NE-45
FOR: NEIMAN®

NE-45.P
FOR: NEIMAN®

FOR: PEUGEOT®

...
101-499
751-795
A00-A99

SUZU-13.P
FOR: SUZUKI®
FOR: LAVERDA® -AUGUSTA® -PEUGEOT® -SUZUKI®

...1-1625
...5001-6278
E...1-710

ZA-1
FOR: ZADI®
FOR: BRETER®

FOR: PGO®

PGO-1
FOR: PGO®

PGO-2.P
FOR: PGO®

FOR: PIAGGIO®

...0.../...0...
...0.../...0...
AA.../BA...
CA.../EA...
Z.../Z...
Z.../Z...
Z.../Z...
1 AL 5

NE-6
FOR: NEIMAN®

...0.../...0...
...0.../...0...
AA.../BA...
CA.../EA...
Z.../Z...
Z.../Z...
Z.../Z...
1 AL 5

NE-6.P
FOR: NEIMAN®

...0.../...0...
...0.../...0...
AA.../BA...
CA...
1 AL 5

NE-8
FOR: NEIMAN®
FOR: CLAUSOR®

...1-1625
...5001-6278
E...1-710

STS-11
FOR: PIAGGIO®

...1-1625
...5001-6278
E...1-710

ZA-1
FOR: ZADI®
FOR: BRETER®

...1-1625
...5001-6278
E...1-710

ZA-1.P
FOR: ZADI®
FOR: BRETER®

FOR: PIAGGIO®

FOR:
CROMODORA®
FIST®
FREA®
GIOBERT®
MIRAGLIO®
RUFFINI®

A
0501-3278
0,4,6,8,9

AF-7I
FOR: SIPEA®
FOR: SAFE®

A
0501-3278
0,4,6,8,9

AF-7D
FOR: SIPEA®
FOR: SAFE®

A
0501-3278
0,4,6,8,9

AF-7I.P
FOR: SIPEA®
FOR: SAFE®

H
01-78

AF-8I
FOR: SIPEA®
FOR: SAFE®

H
01-78

AF-8D
FOR: SIPEA®
FOR: SAFE®

H
01-78

AF-8I.P
FOR: SIPEA®
FOR: SAFE®

H
01-78

AF-8D.P
FOR: SIPEA®
FOR: SAFE®

F
01-78

AF-9I
FOR: SIPEA®
FOR: SAFE®

F
01-78

AF-9D
FOR: SIPEA®
FOR: SAFE®

F
01-78

AF-9I.P
FOR: SIPEA®
FOR: SAFE®

F
01-78

AF-9D.P
FOR: SIPEA®
FOR: SAFE®

6
100-309

AF-5I
FOR: SAFE®

8
100-309

AF-5D
FOR: SAFE®

2
100-309

AF-6I
FOR: SAFE®

4
100-309

AF-6D
FOR: SAFE®

CL-2I
CL-2D
CL-3I

CL-2I
FOR: CLAUSOR®

CL-2D
FOR: CLAUSOR®

CL-3I
FOR: CLAUSOR®

FOR: PIAGGIO®

F
01-78

FEM-1I
FOR: FEMSA®

E
01-78

FEM-1D
FOR: FEMSA®

H
01-78

FEM-2I
FOR: FEMSA®

G
01-78

FEM-2D
FOR: FEMSA®

J
3001-6732
N
6001-7000

FI-1
FOR: GIOBERT®

J
3001-6732
N
6001-7000

FI-1.P
FOR: GIOBERT®

J
3001-6732
N
6001-7000

FI-10
FOR: GIOBERT®

W
0001-9640

FI-13.P1
FOR: GIOBERT®

2
100-309

FAB-1
FOR: FAAB®

FOR: PIAGGIO®

...5001-6475

ZA-13.P
FOR: ZADI®
FOR: BASTA® -VIRO® -LML®

...1-700
...8001-9554

ZA-4D.P
FOR: ZADI®

...2001-3554
...8001-9554

ZA-2.P
FOR: ZADI®

8001-9554

ZA-7D.P1
FOR: ZADI®

8001-9554

ZA-9.P2
FOR: ZADI®

8001-9554

ZA-6D.P1
FOR: ZADI®

8001-9554

ZA-7D.P
FOR: ZADI®

8001-9554

ZA-9.P
FOR: ZADI®

FOR: PIAGGIO®

...5001-6475

ZA-13.P
FOR: ZADI®
FOR: LML®

FOR: RALEIGH®

NRA
FFE...1-100
FJA...1-100
FL...251-500
NRA...51-90
YFB...1-75
FMD...1-75
FG...1-30
NF...1-30
EJR...1-75

UN-FFE
FOR: UNION®

UN-3
UN-FP

MC...1-40
MRA...251-290
MRN...1-54
MRN...201-250
MRN...251-300

UN-MRN
FOR: UNION®

HX...100
751-875

UN-2
FOR: UNION®

FR...
UN-FR

FS...1-99
FS...876-955

UN-1FS
FOR: UNION®

FA...
501-625

UN-44
FOR: UNION®

RM...
911-952

UN-44D
FOR: UNION®

NGN...1-54
UN-NG

FOR: RIZZATO®

...5001-6475

ZA-13.P
FOR: ZADI®
FOR: BASTA® -VIRO® -LML®

...1-700
...8001-9554

ZA-4D.P
FOR: ZADI®

...2001-3554
...8001-9554

ZA-2.P
FOR: ZADI®

Concerning the marks and commercial denominations see legal warning.
Concerniente a las marcas y denominaciones comerciales ver aviso legal.
Marka eta izendapen komertzialiei dagokienez, ikus lege-oharra.
Concernant les marques et denominations commerciales voir la note dans l'index.

JMA Opening the future

JMA Opening the future

Beziehen auf die marke und handelsname sehen sie die notiz im Impressum.
Relativamente às marcas e denominações comerciais, ver aviso legal.
Jeśli chodzi o znaki i nazwy handlowe, patrz Informacje prawne.

K04 / 339

FOR: SULKI®

FOR: SUZUKI®

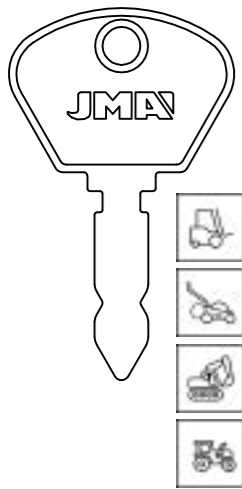

BH-4
FOR: BOSCH®
FOR: KOLB® -POLAR®

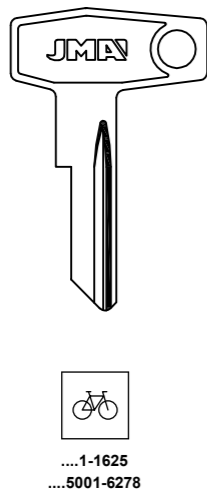

...1-1625
...5001-6278
E...1-710
ZA-1
FOR: ZADI®
FOR: BRETER®

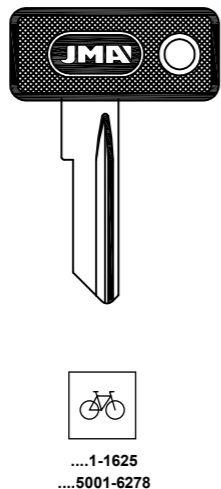

...1-1625
...5001-6278
E...1-710
ZA-1.P
FOR: ZADI®
FOR: BRETER®

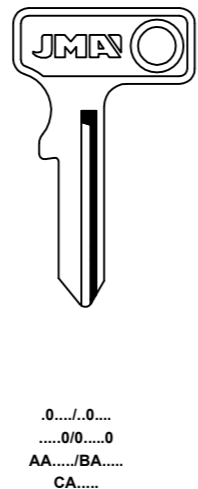

.0.../...0...
...0/0...0
AA.../BA...
CA...
1 AL 5
NE-8
FOR: NEIMAN®
FOR: CLAUSOR®

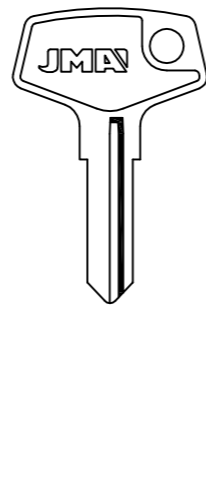

...4
SUZU-3I
FOR: SUZUKI®

FOR: SUZUKI®

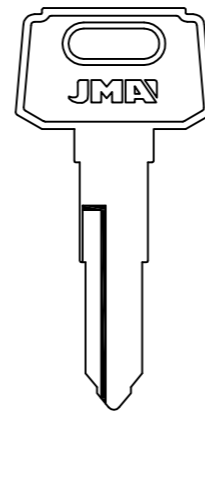

1 AL 4
32010-79897
A....
32010-79897
YAMA-18I
C....
32010-79897
YAMA-19I
E....
32010-79897
YAMA-20I
FOR: YAMAHA®

B....
32010-79897
YAMA-18D
D....
32010-79897
YAMA-19D
F....
32010-79897
YAMA-20D
FOR: YAMAHA®

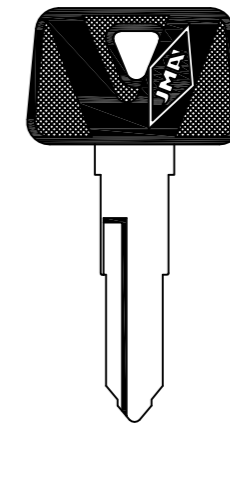

1 AL 4
32010-79897
A....
32010-79897
YAMA-18I.P
C....
32010-79897
YAMA-19I.P
E....
32010-79897
YAMA-20I.P
C....
32010-79897
YAMA-28.P
E....
32010-79897
YAMA-29.P
FOR: YAMAHA®

B....
32010-79897
YAMA-18D.P
D....
32010-79897
YAMA-19D.P
F....
32010-79897
YAMA-20D.P

FOR: SUZUKI®

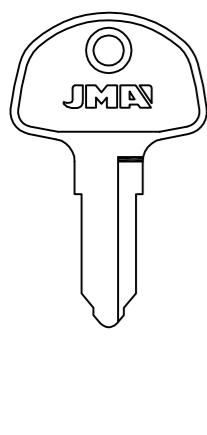

...
101-499
751-795
A00-A99
SUZU-4I
FOR: SUZUKI®
FOR: LAVERDA® -AUGUSTA® -PEUGEOT® -SUZUKI®

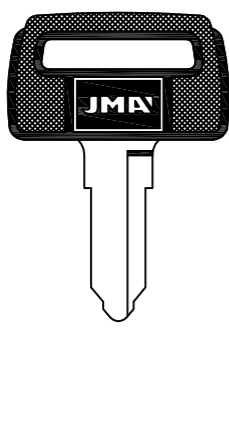

...
101-499
751-795
A00-A99
SUZU-4I.P
FOR: SUZUKI®

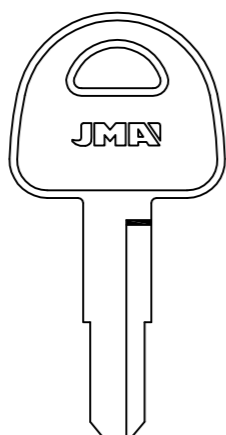

...
101-499
751-795
SUZU-5
FOR: SUZUKI®

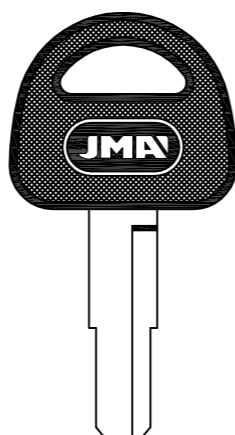

...
101-499
751-795
SUZU-5.P
FOR: SUZUKI®

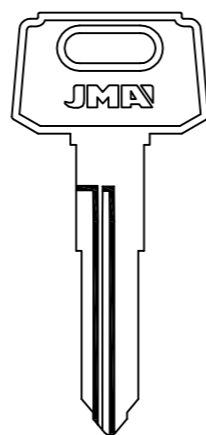

...
6001-7000
SUZU-11D
FOR: SUZUKI®

FOR: SUZUKI®

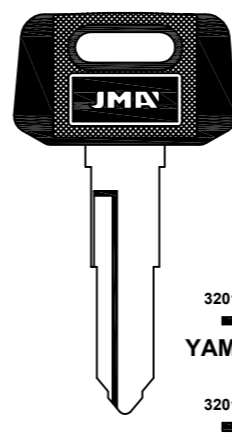

1 AL 4
32010-79897
A....
32010-79897
YAMA-22I.P
C....
32010-79897
YAMA-23I.P
E....
32010-79897
YAMA-24I.P
FOR: YAMAHA®

B....
32010-79897
YAMA-22D.P
D....
32010-79897
YAMA-23D.P
F....
32010-79897
YAMA-24D.P

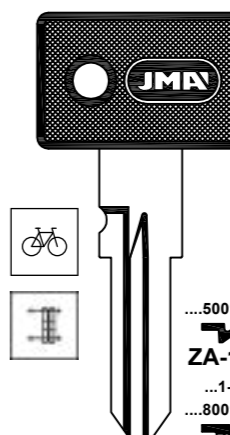

...5001-6475
ZA-13.P
...1-700
...8001-9554
ZA-4D.P
...2001-3554
...8001-9554
ZA-2.P
FOR: ZADI®
FOR: BASTA® -VIRO® -LML®

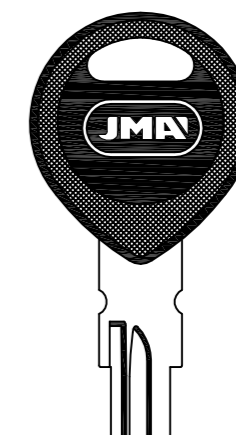

8001-9554
ZA-9.P1
FOR: ZADI®

FOR: SWM®

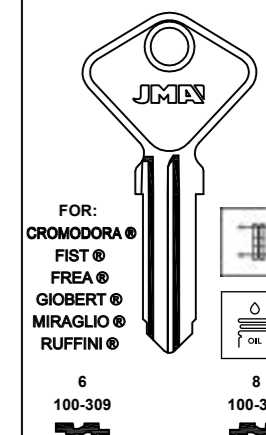

FOR: CROMODORA®
FIST®
FREA®
GIOBERT®
MIRAGLIO®
RUFFINI®
6
100-309
AF-5I
2
100-309
AF-6I
8
100-309
AF-5D
4
100-309
AF-6D
FOR: SAFE®

FOR: SUZUKI®

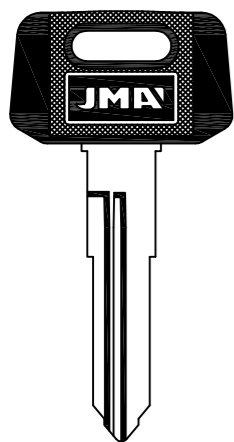

...
6001-7000
SUZU-11D.P
FOR: SUZUKI®



...
6001-7000
SUZU-12.P
FOR: SUZUKI®

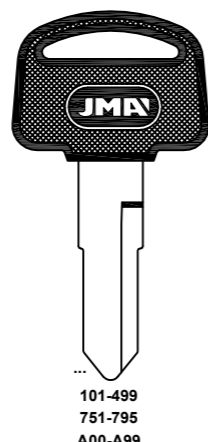

...
101-499
751-795
A00-A99
SUZU-13.P
SUZU-13D.P
FOR: SUZUKI®

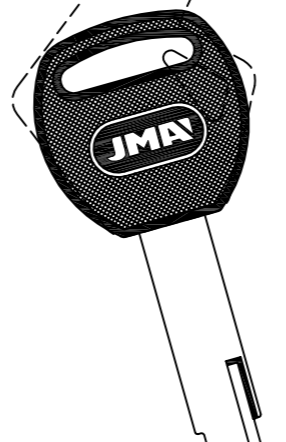

SUZU-21.P
FOR: SUZUKI®

FOR: LAVERDA® -AUGUSTA® -PEUGEOT® -SUZUKI®

FOR: SWM®

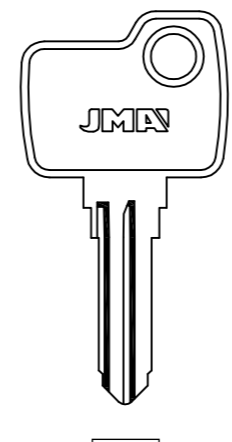

6
100-517
FAR-1I
2
100-517
FAR-2I
H
100-309
FAR-3
FOR: FARMA®
FOR: FISAM®

8
100-517
FAR-1D
4
100-517
FAR-2D
FAR-3D
FAR-4D

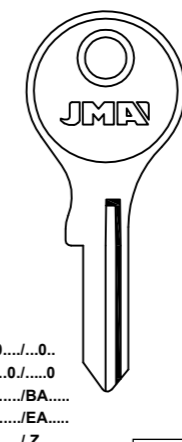

.0.../...0...
...0/...0
AA.../BA...
CA.../EA...
Z.../Z...
...Z.../Z...
...Z.../Z...
1 AL 5
NE-6
FOR: NEIMAN®

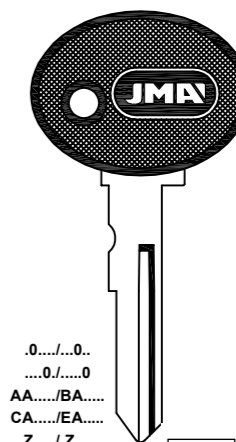

.0.../...0...
...0/...0
AA.../BA...
CA.../EA...
Z.../Z...
...Z.../Z...
...Z.../Z...
1 AL 5
NE-6.P
FOR: NEIMAN®

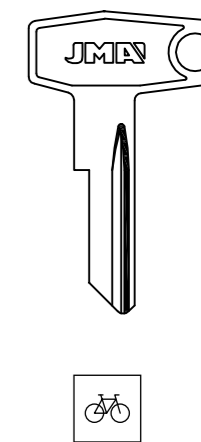

...1-1625
...5001-6278
E...1-710
ZA-1
FOR: ZADI®
FOR: BRETER®

Concerning the marks and commercial denominations see legal warning.
Concerniente a las marcas y denominaciones comerciales ver aviso legal.
Marka eta izendapen komertzialiei dagokienez, ikus lege-oharra.
Concernant les marques et denominations commerciales voir la note dans l'index.



JMA Opening the future

JMA Opening the future

Beziehen auf die marke und handelsname sehen sie die notiz im Impressum.
Relativamente às marcas e denominações comerciais, ver aviso legal.
Jeśli chodzi o znaki i nazwy handlowe, patrz Informacje prawne.

K04 / 341

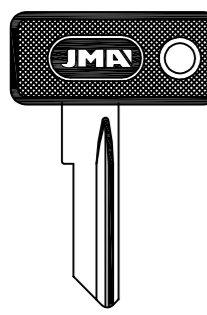
FOR: SWM®





...1-1625
...5001-6278
E...1-710

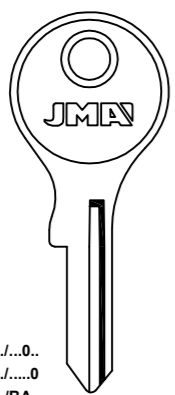

ZA-1.P
FOR: ZADI®
FOR: BRETER®

FOR: TESTI®





.0.../...0.
...0.../...0
AA.../BA...
CA.../EA...
Z.../Z...
...Z.../...Z...
...Z.../...Z
1 AL 5

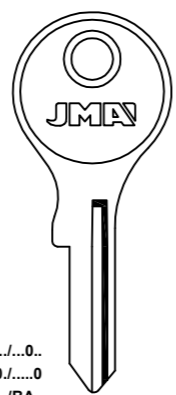

NE-6
FOR: NEIMAN®

FOR: TRIUMPH®





.0.../...0.
...0.../...0
AA.../BA...
CA.../EA...
Z.../Z...
...Z.../...Z...
...Z.../...Z
1 AL 5

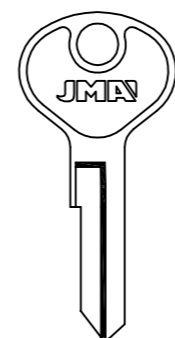

NE-6
FOR: NEIMAN®

VARIOUS BRANDS

TIT-7D
FOR: TITAN®

FOR: YAMAHA®

.0.../...0.
...0.../...0
AA.../BA...
CA.../EA...
Z.../Z...
...Z.../...Z
1 AL 5

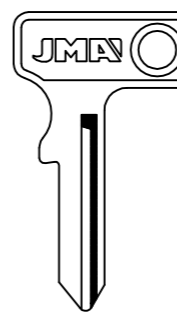
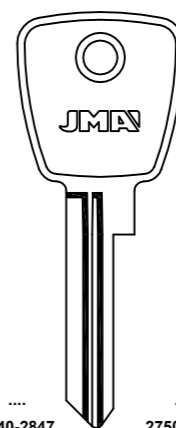
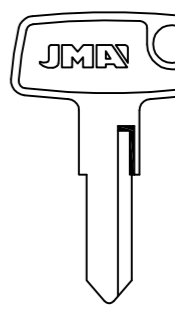
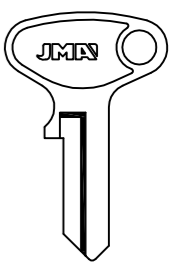
NE-8
FOR: NEIMAN®
FOR: CLAUSOR®

2840-2847
YAMA-11
2550-2557
YAMA-21

2750-2757
YAMA-1D
2640-2647
YAMA-2D

2611-2650
YAMA-31

1711-1725
YAMA-3D

YAMA-4D
FOR: YAMAHA®

FOR: TRIUMPH®

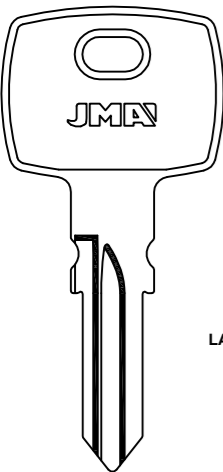
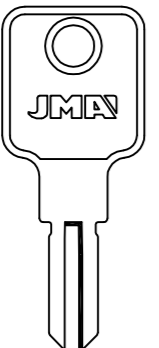
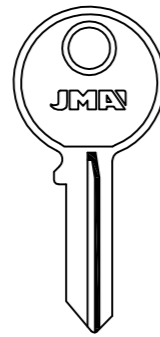
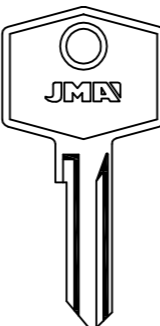
NRA
FFE...1-100
FJA...1-100
FL...251-500
NRA...51-90
YFB...1-75
FMD...1-75
FG...1-30
NF...1-30
EJR...1-75

FP...
626-750

UN-FFE **UN-3** **UN-FP**

MC...1-40
MRA...251-290
MRN...1-54
MRN...201-250
MRN...251-300

HX...100
751-875

UN-MRN **UN-2** **UN-FR**

FS...1-99
FS...876-955

FA...
501-625

RM...
911-952

NGN...1-54

UN-1FS **UN-44** **UN-44D** **UN-NG**

FK...
01-99
876-955

FS...
01-99
876-955

UN-FK **UN-FS**

FOR: TRIUMPH MOT.®
FOR: ZADI®

FOR: TRIUMPH MOT.®

FOR: UNION®

FOR: UNION®
FOR: WBH®

FOR: YAMAHA®

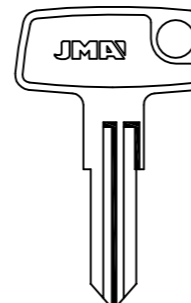
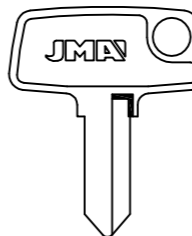
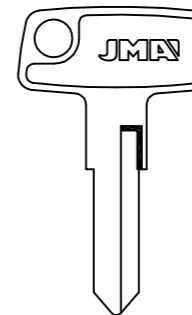
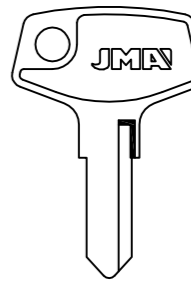
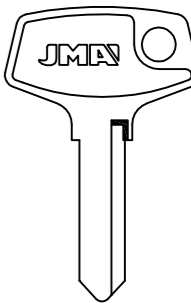
2651-2675
YAMA-5I
FOR: YAMAHA®

1751-1775
YAMA-5D
FOR: YAMAHA®

228-234
YAMA-6I

221-227
YAMA-6D
FOR: YAMAHA®

2676-2700
YAMA-7I

1776-1800
YAMA-7D
FOR: YAMAHA®

2109-2115
2611-2625
6201-6212

1209-1215
1711-1725
6101-6112

YAMA-8I **YAMA-8D**
FOR: YAMAHA®

A201-A206
B201-B206

A101-A106
B101-B106

YAMA-9I **YAMA-9D**
FOR: YAMAHA®

FOR: TRIUMPH®

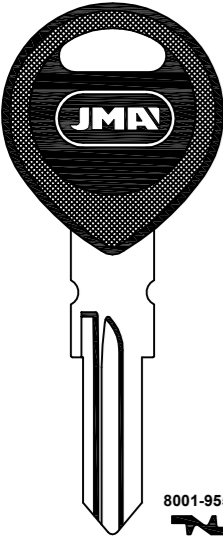

8001-9554



ZA-9.P1
FOR: ZADI®

VARIOUS BRANDS

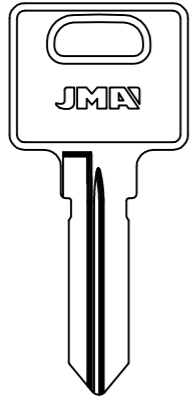
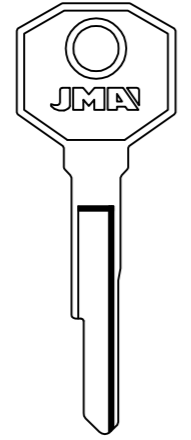
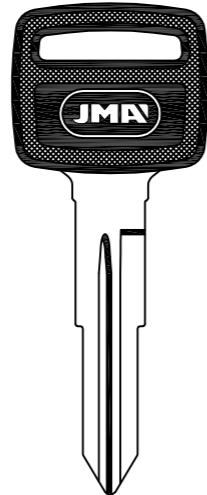
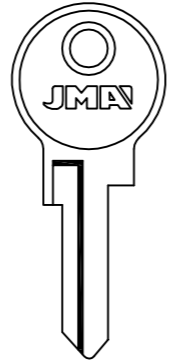
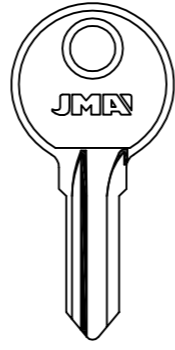
21...
0001-9999



AS-19D
FOR: ASSA®

BUR-6
FOR: BURG®

DAL-1.P
FOR: DAELIM®

GW-1D
FOR: ZUNDAPP®

R
001-224
LAS-R

V
001-224
LAS-V

Y
001-224
LAS-Y

FOR: LAS®

FOR: YAMAHA®

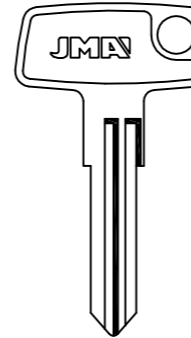
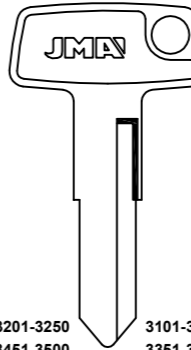
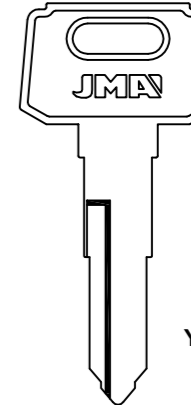
3801-3850
4251-4300
4851-4900

YAMA-14I **YAMA-14D**

3401-3450
4051-4100
4651-4700

YAMA-15I **YAMA-15D**

3201-3250
3451-3500
4401-4450

YAMA-12I **YAMA-12D**

3101-3150
3351-3400
4301-4350

YAMA-13I **YAMA-13D**

3251-3300
3851-3900
4451-4500

YAMA-16I **YAMA-16D**

3651-3700
4201-4250
4801-4850

YAMA-17I **YAMA-17D**

3701-3750
4151-4200
4751-4800

3301-3350
3951-4000
4551-4600

3551-3600
4101-4150
4701-4750

YAMA-18I **YAMA-18D**

32010-79897

A...
32010-79897

B...
32010-79897

YAMA-19I **YAMA-19D**

C...
32010-79897

D...
32010-79897

YAMA-20I **YAMA-20D**
FOR: YAMAHA®

E...
32010-79897

F...
32010-79897

Concerning the marks and commercial denominations see legal warning.
Concerniente a las marcas y denominaciones comerciales ver aviso legal.
Marka eta izendapen komertzialiei dagokienez, ikus lege-oharra.
Concernant les marques et dénominations commerciales voir la note dans l'index.



FOR: YAMAHA®

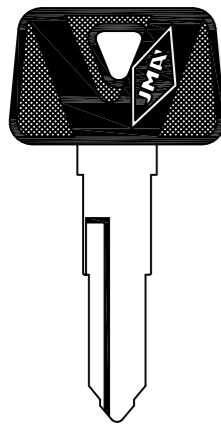

1 AL 4
32010-79897

A.....
32010-79897
YAMA-18I.P

B.....
32010-79897
YAMA-18D.P

C.....
32010-79897
YAMA-19I.P

D.....
32010-79897
YAMA-19D.P

E.....
32010-79897
YAMA-20I.P

F.....
32010-79897
YAMA-20D.P

C.....
32010-79897
YAMA-28.P

E.....
32010-79897
YAMA-29.P
FOR: YAMAHA®

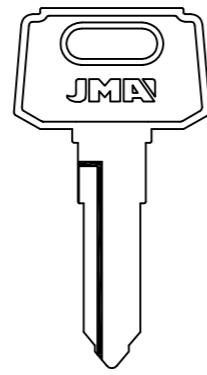

.....
7001-8000
YAMA-21I
FOR: YAMAHA®

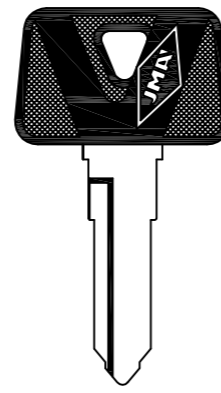

.....
7001-7999
YAMA-21I.P
FOR: YAMAHA®

FOR: YAMAHA®

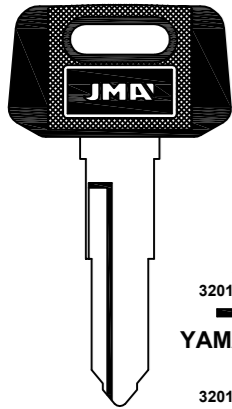

1 AL 4
32010-79897

A.....
32010-79897
YAMA-22I.P

B.....
32010-79897
YAMA-22D.P

C.....
32010-79897
YAMA-23I.P

D.....
32010-79897
YAMA-23D.P

E.....
32010-79897
YAMA-24I.P
FOR: YAMAHA®

F.....
32010-79897
YAMA-24D.P

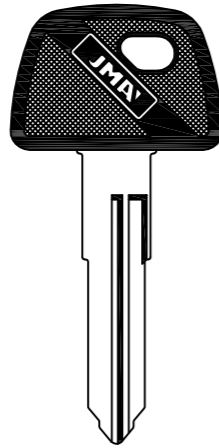

.....
6001-7000
YAMA-25.P
FOR: YAMAHA®

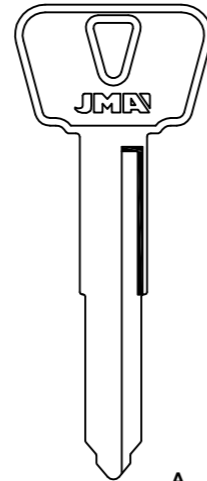

A.....
7000-8000
YAMA-26
FOR: YAMAHA®

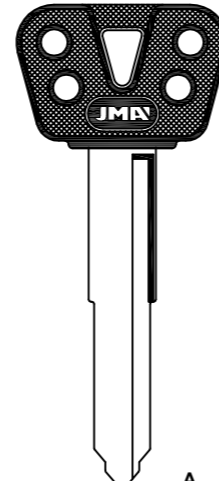

A.....
7000-8000
YAMA-26P
FOR: YAMAHA®

FOR: YAMAHA®

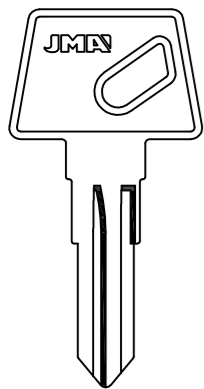

.....3000
YAMA-27
FOR: YAMAHA®

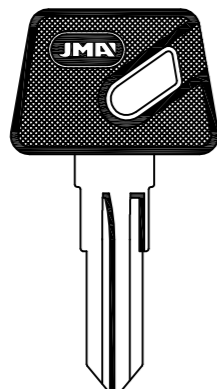

.....3000
YAMA-27P

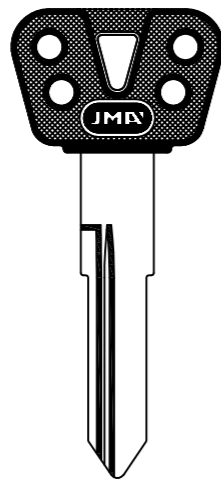

.....7000
YAMA-30.P
FOR: YAMAHA®

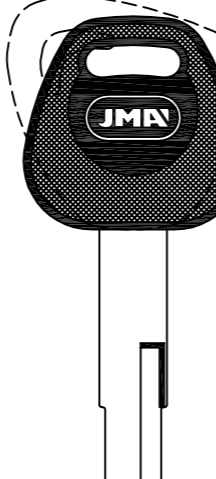

.....4000
YAMA-32D.P
FOR: YAMAHA®

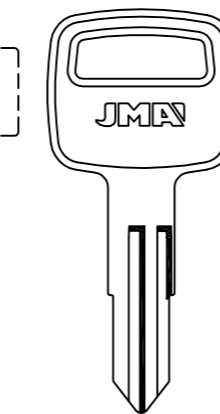

.....
YAMA-33.P1
FOR: YAMAHA®

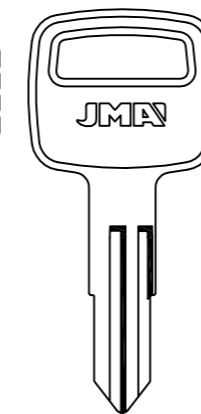

.....
YAMA-34
FOR: YAMAHA®

FOR: YAMAHA®

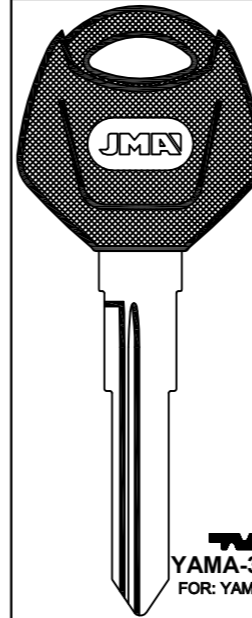

LAT.
YAMA-36D.P
FOR: YAMAHA®

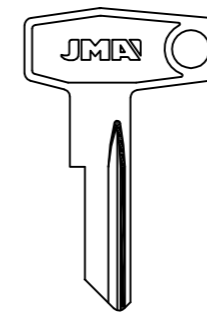

.....1-1625
.....5001-6278
E...1-710
ZA-1
FOR: ZADI®
FOR: BRETER®

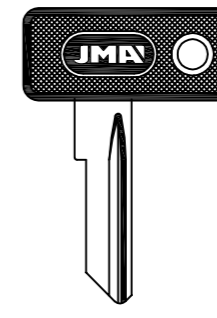

.....1-1625
.....5001-6278
E...1-710
ZA-1.P
FOR: ZADI®
FOR: BRETER®

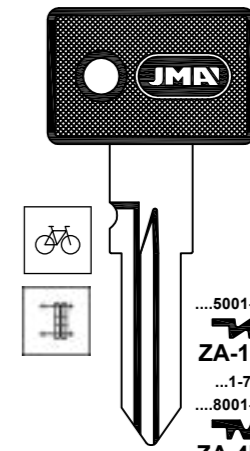

.....5001-6475
ZA-4D.P
.....1-700
.....8001-9554
.....2001-3554
.....8001-9554
ZA-2.P
FOR: ZADI®
FOR: BASTA® -VIRO® -LML®

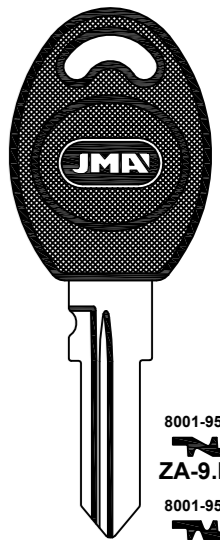

8001-9554
ZA-9.P2
8001-9554
ZA-6D.P1
FOR: ZADI®

FOR: YAMAHA®

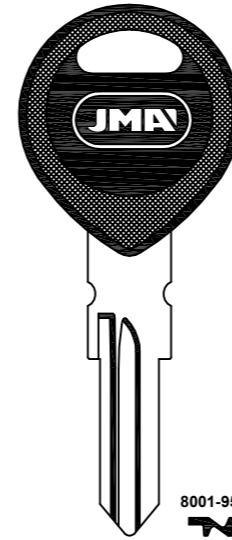

8001-9554
ZA-9.P1
FOR: ZADI®

Concerning the marks and commercial denominations see legal warning.
Concerniente a las marcas y denominaciones comerciales ver aviso legal.
Marka eta izendapen komertzialiei dagokienez, ikus lege-oharra.
Concernant les marques et dénominations commerciales voir la note dans l'index.

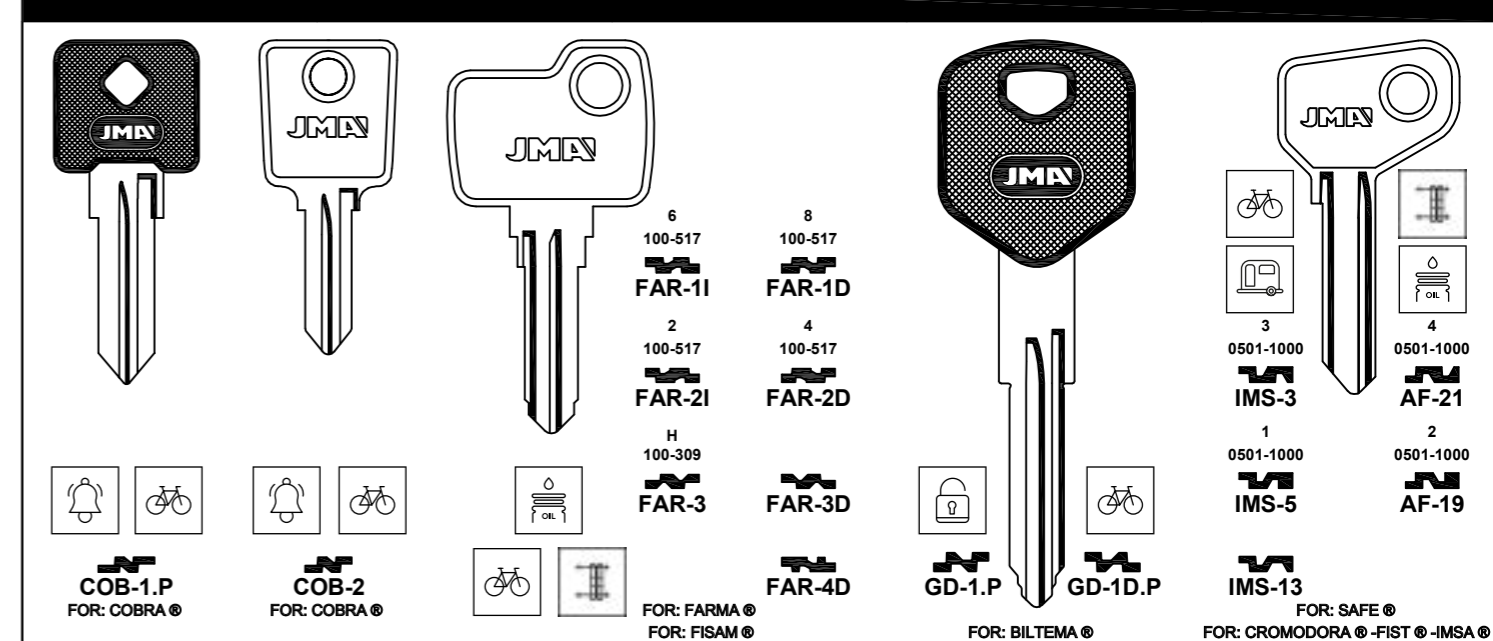
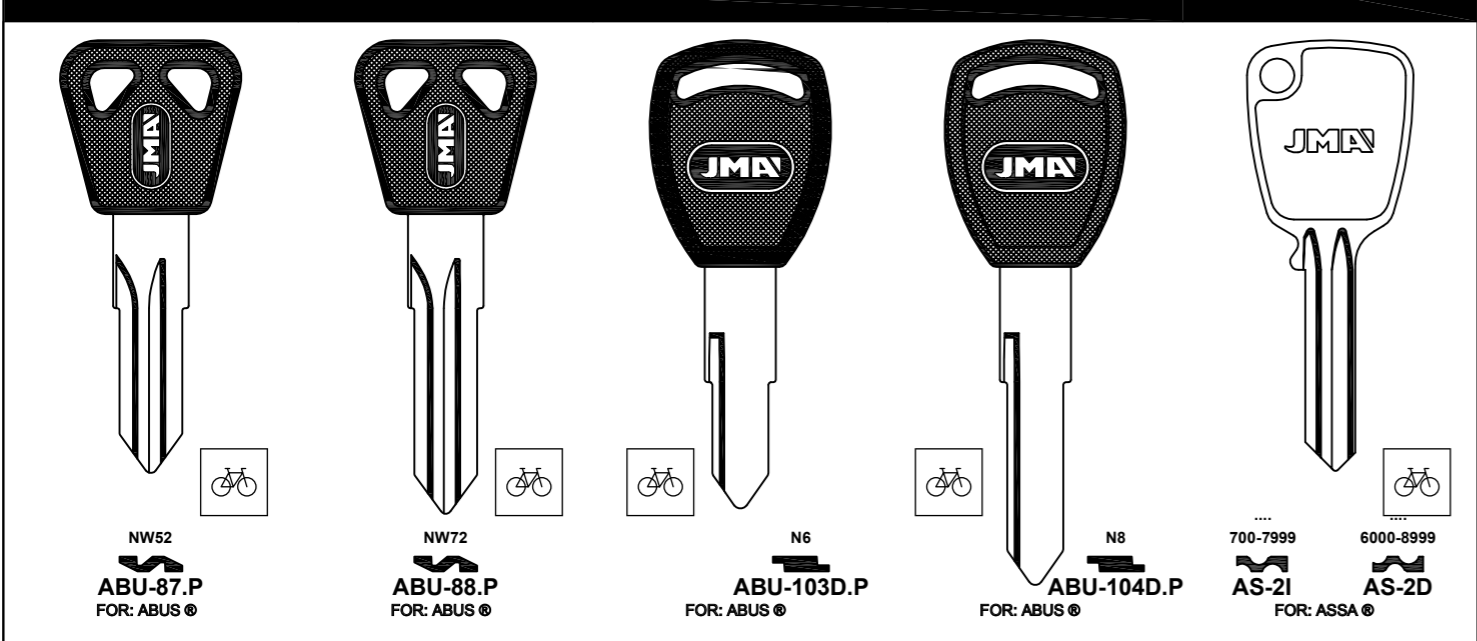
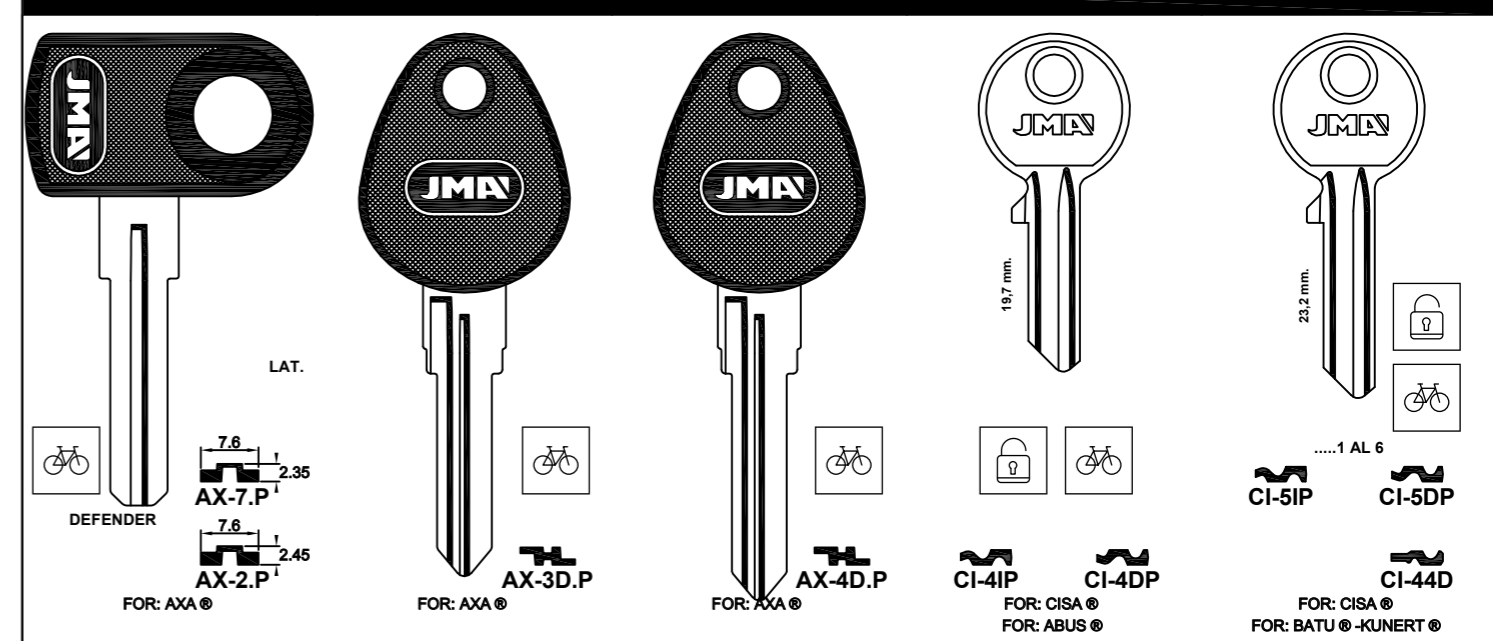
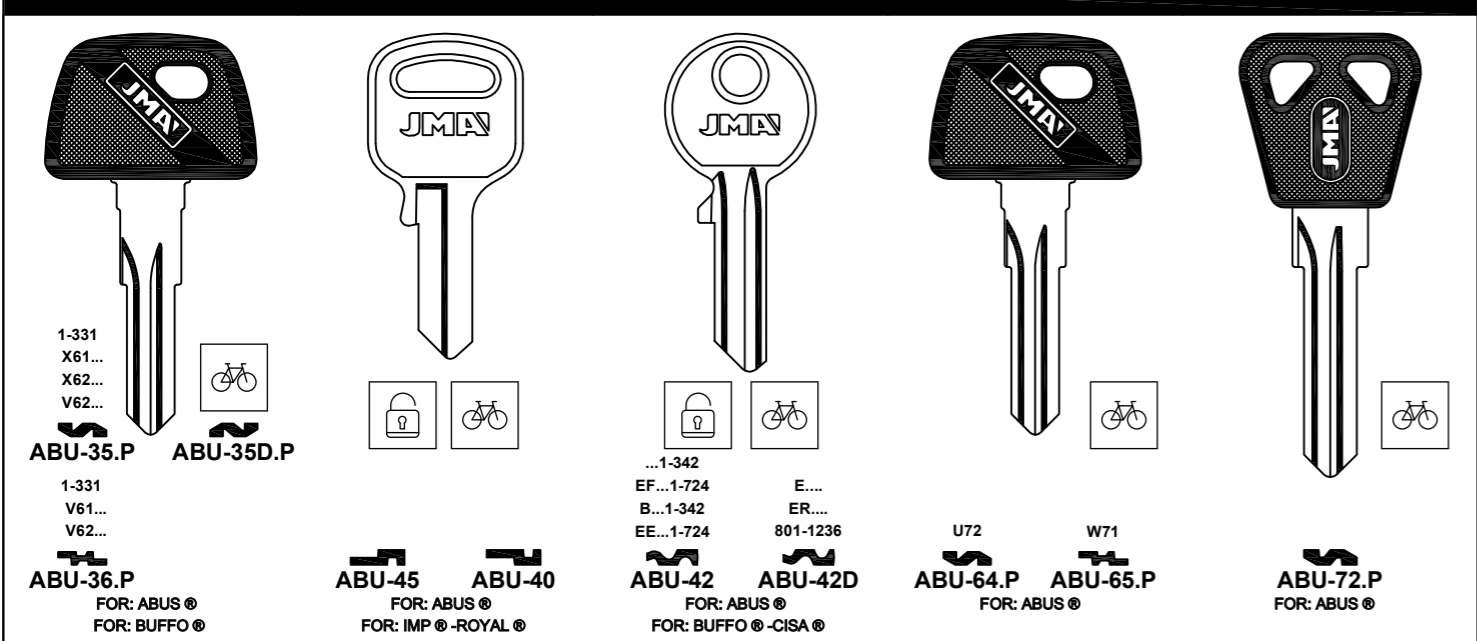
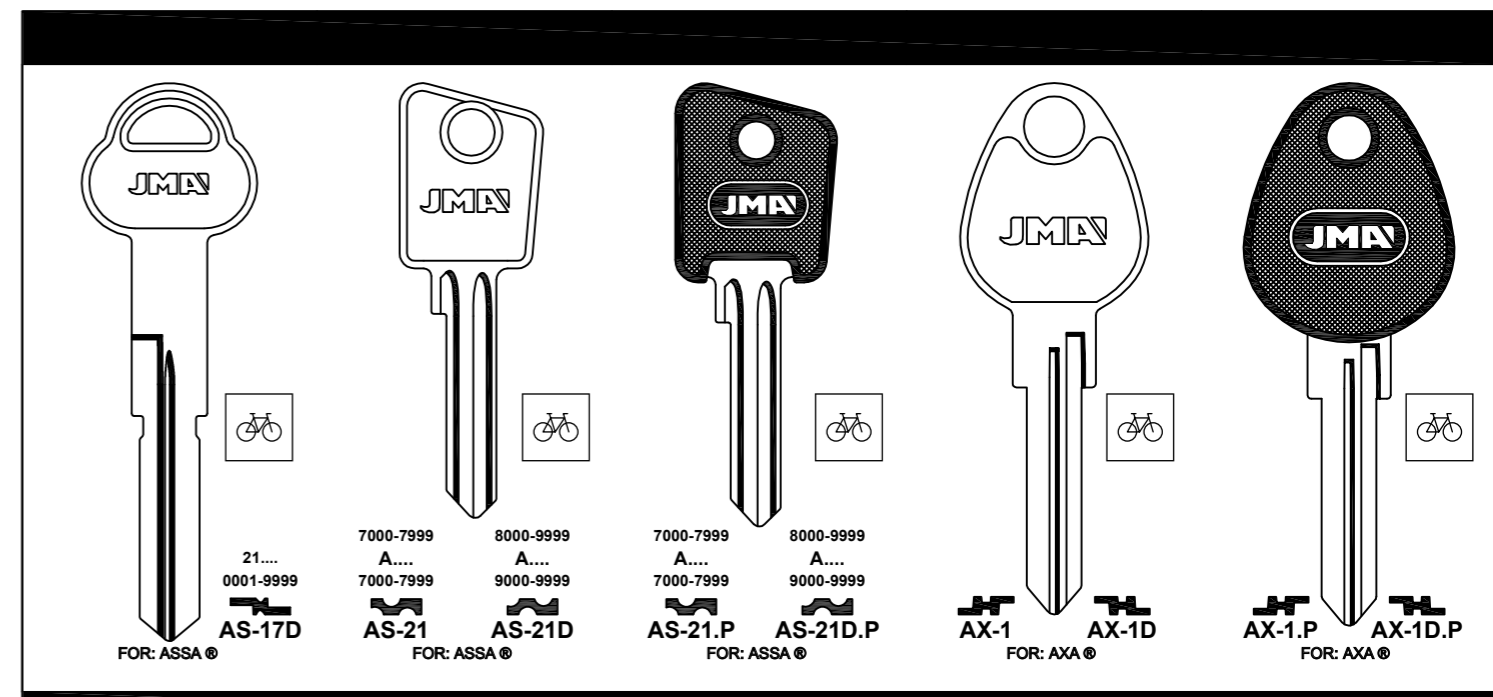
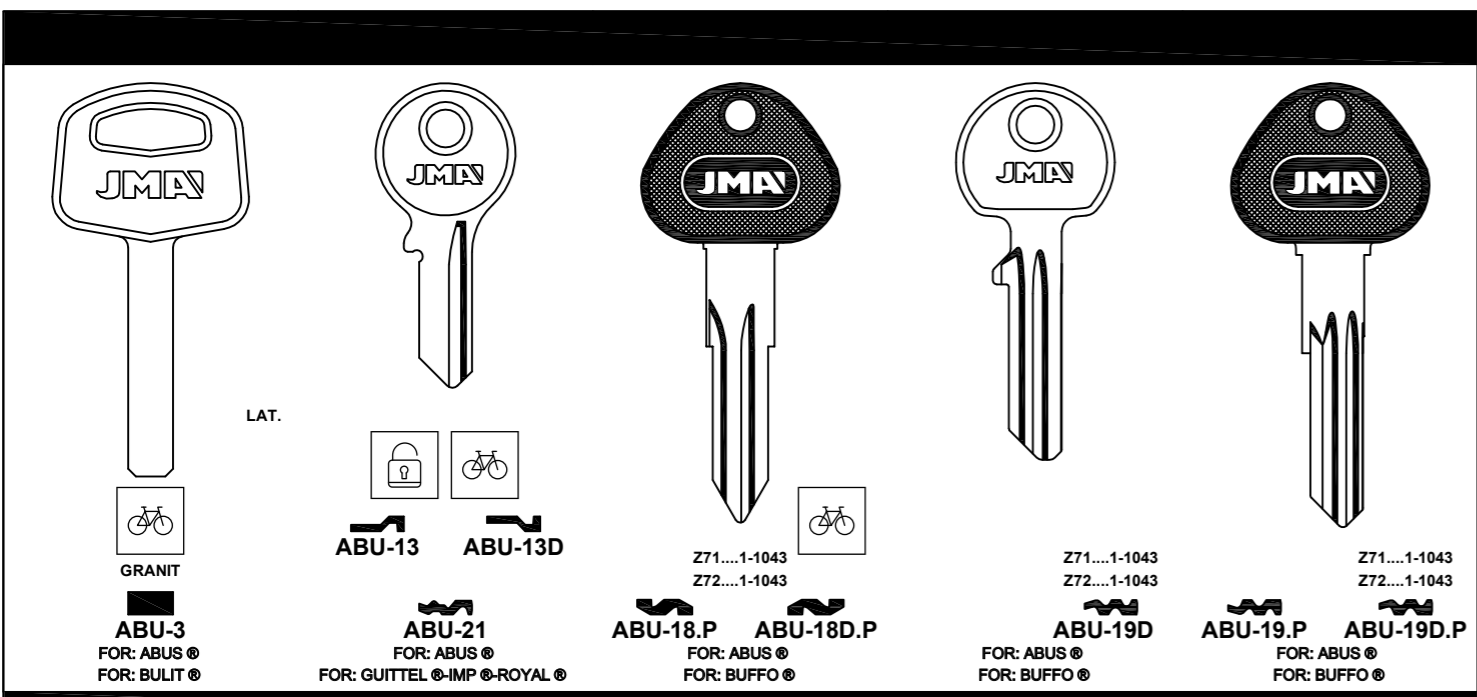

Concerning the marks and commercial denominations see legal warning.
 Concerniente a las marcas y denominaciones comerciales ver aviso legal.
 Marka eta izendapen komertzialiei dagokienez, ikus lege-oharra.
 Concernant les marques et dénominations commerciales voir la note dans l'index.

<p>FOR: ASTON MARTIN® JAGUAR® LAND ROVER® MG® ROVER® VOLVO®</p> <p>FP 626-750 IN-1</p> <p>FK 01-99 876-955</p> <p>FS 01-99 876-955</p> <p>FR 751-875</p> <p>UN-4</p> <p>FOR: UNION®</p>	<p>FOR: ABBES® ATAL® DUBOIS® ORDO® RENZ® STRAFOR® RONIS®</p> <p>FH 001-400 501-550</p> <p>FM LAS-2</p> <p>FM 001-400 501-550 LAS-4</p> <p>FH 001-400 501-550 LAS-FH</p> <p>H LAS-5</p> <p>U LAS-U</p> <p>FOR: LAS® FOR: KIFERM®</p>	<p>TA LAS-6</p> <p>RM 0001-2000 KT 3001-4000 LAS-KT</p> <p>AT LAS-6D</p> <p>TK 4001-5000 LAS-TK</p> <p>FOR: LAS® FOR: ATAL® -KIFERM® -MARCADET®</p>	<p>0501-1000 IMS-3.P</p> <p>0501-1000 AF-21.P</p> <p>0501-1000 IMS-5.P</p> <p>0501-1000 AF-19.P</p> <p>0501-1000 IMS-13.P</p> <p>FOR: SAFE® FOR: CROMODORA® -FIST® -IMS®</p>	<p>3 0501-1000 IMS-3.P</p> <p>4 0501-1000 AF-21.P</p> <p>1 0501-1000 IMS-5.P</p> <p>2 0501-1000 AF-19.P</p> <p>IMS-13.P</p>

<p>18 mm</p> <p>90...1-200 ...1-400 91...201-275 GH...1-4000 SS...1-400 91...276-350</p> <p>LF-11 LF-1D</p> <p>FOR: LOWE & FLETCHER® FOR: CEM® -EURO LOCKS® -UNION®</p>	<p>70001-71000 M..... 70001-71000</p> <p>LF-5 LF-5D</p> <p>FOR: LOWE & FLETCHER® FOR: TELFORD®</p>	<p>18.6 mm</p> <p>60... 001-200 60... 001-200 90... 001-200 ...1-400 GHM...1-155 M...1-400 RV...1-400 RVM...1-400 SP...1-400 99...1-400</p> <p>LF-15 LF-15D</p> <p>FOR: LOWE & FLETCHER® FOR: CEM® -EURO LOCKS® -ULTRA® -UNION®</p>	<p>A1101-A1112 LUMA-1I</p> <p>B3301-B3312 LUMA-2I</p> <p>A2201-A2212 LUMA-1D</p> <p>B4401-B4412 LUMA-2D</p> <p>C5501-A5512 LUMA-3I</p> <p>LUMA-4I</p> <p>C6601-C6612 LUMA-3D</p> <p>LUMA-4D</p> <p>FOR: LUMA® FOR: BASTA® -RONIS®</p>	<p>NRA FFE...1-100 FJA...1-100 FL...251-500 NRA...51-90 YFB...1-75 FMD...1-75 FG...1-30 NF...1-30 EJR...1-75</p> <p>UN-FFE</p> <p>MC...1-40 MRA...251-290 MRN...1-54 MRN...201-250 MRN...251-300</p> <p>UN-MRN</p> <p>FS...1-99 FS...876-955 UN-1FS</p> <p>FA... 501-625 UN-44</p> <p>FOR: UNION®</p>	<p>FP... 626-750 UN-FP</p> <p>HX...100 UN-2</p> <p>FR... 751-875 UN-FR</p> <p>RM... 911-952 UN-44D</p> <p>UN-NG</p> <p>FOR: UNION® FOR: WB®</p>	<p>FK... 01-99 876-955 UN-FK</p> <p>FS... 01-99 876-955 UN-FS</p> <p>FOR: UNION® FOR: WB®</p>	<p>...0 AL 5</p> <p>VI-4IP VI-4DP</p> <p>FOR: VIRO® FOR: ABUS® -ROYAL®</p>	<p>FOR: ABUS® BENDIX® CAB® CHICAGO® COLE HERSEE®</p> <p>USA GB ALU.</p> <p>YA-11I YA-11D</p> <p>FOR: YALE®</p>	

<p>MQ-1I MQ-1D</p> <p>FOR: MARQUES®</p>	<p>5001-6278 NE-30</p> <p>FOR: NEIMAN® FOR: BASTA®</p>	<p>5001-6278 NE-30.P</p> <p>FOR: NEIMAN® FOR: BASTA®</p>	<p>...1/9...A/Z M-N-P-R-S NE-31</p> <p>FOR: NEIMAN® FOR: BASTA®</p>	<p>...1/9...A/Z M-N-P-R-S NE-31.P</p> <p>FOR: NEIMAN® FOR: BASTA®</p>

<p>NE-32</p> <p>FOR: NEIMAN® FOR: BASTA®</p>	<p>NE-32.P</p> <p>FOR: NEIMAN® FOR: BASTA®</p>	<p>LAT.</p> <p>STS-X6</p> <p>FOR: STS® FOR: TESA®</p>	<p>TRL-1.P</p> <p>FOR: TRELOCK®</p>	

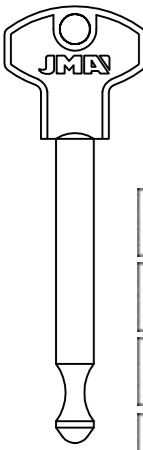
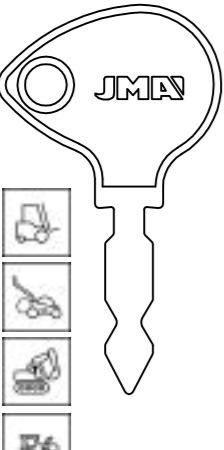
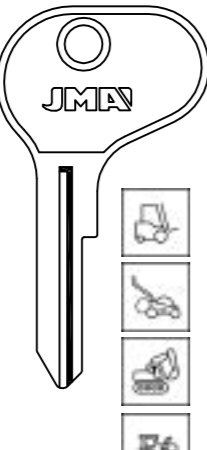
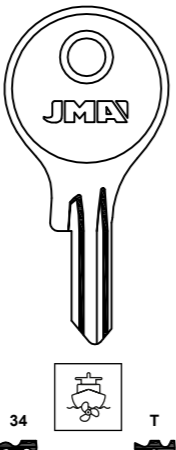
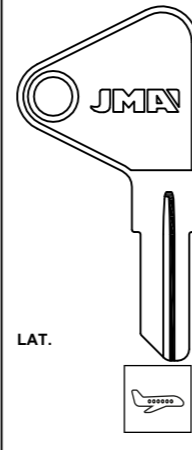
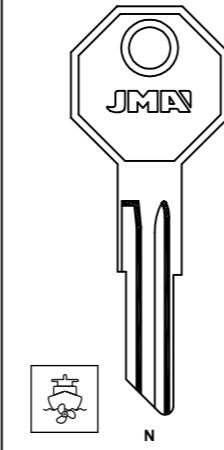

<p>FS...1-99 FS...876-955 UN-1FS</p> <p>FA... 501-625 UN-44</p> <p>FOR: UNION®</p>	<p>HX...100 UN-2</p> <p>FR... 751-875 UN-FR</p> <p>RM... 911-952 UN-44D</p> <p>UN-NG</p> <p>FOR: UNION® FOR: WB®</p>	<p>FK... 01-99 876-955 UN-FK</p> <p>FS... 01-99 876-955 UN-FS</p> <p>FOR: UNION® FOR: WB®</p>	<p>...0 AL 5</p> <p>VI-4IP VI-4DP</p> <p>FOR: VIRO® FOR: ABUS® -ROYAL®</p>	<p>FOR: ABUS® BENDIX® CAB® CHICAGO® COLE HERSEE®</p> <p>USA GB ALU.</p> <p>YA-11I YA-11D</p> <p>FOR: YALE®</p>					

<p>...1-1625 ...5001-6278 E...1-710 ZA-1</p> <p>FOR: ZADI® FOR: BRETER®</p>	<p>...1-1625 ...5001-6278 E...1-710 ZA-1.P</p> <p>FOR: ZADI® FOR: BRETER®</p>	<p>...5001-6475 ZA-13.P</p> <p>...1-700 ...8001-9554 ZA-4D.P</p> <p>...2001-3554 ...8001-9554 ZA-2.P</p> <p>FOR: ZADI® FOR: BASTA® -VIRO® -LML®</p>	<p>...1-390 ZA-3D</p> <p>FOR: ZADI®</p>	<p>LAT.</p> <p>ZA-10</p> <p>FOR: ZADI®</p>

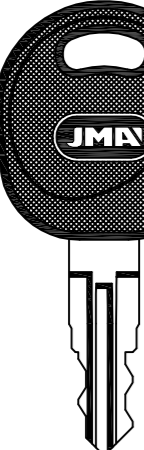
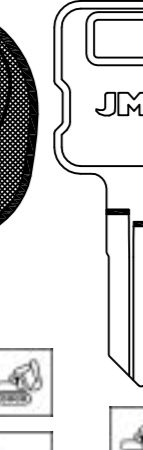
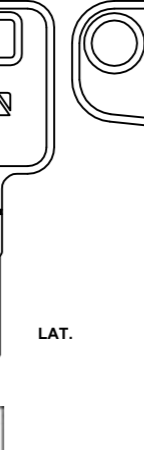
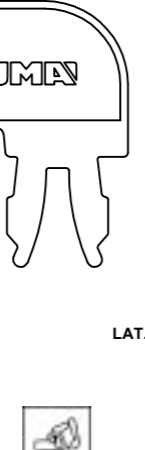
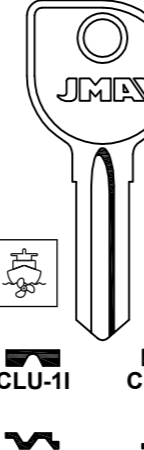
 <p>BH-3</p>	 <p>BH-5</p>	 <p>BH-6</p>	 <p>BK-4</p>	 <p>BK-5D</p>	 <p>BOB-1D</p>
<p>FOR: METEOR® -YALE®</p>		<p>FOR: METEOR® -YALE®</p>		<p>FOR: DEXTER®-POLLAKE®-BOBCAT®</p>	

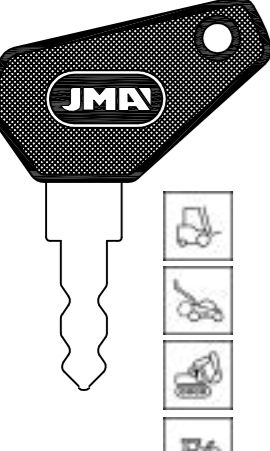
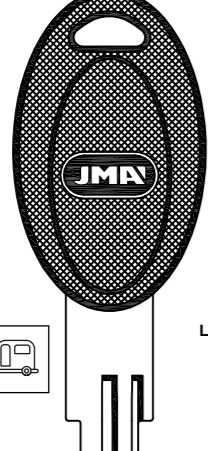
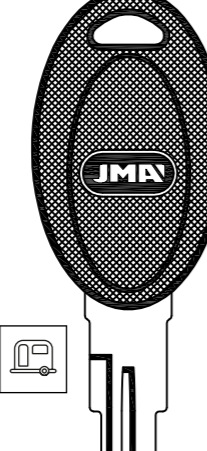
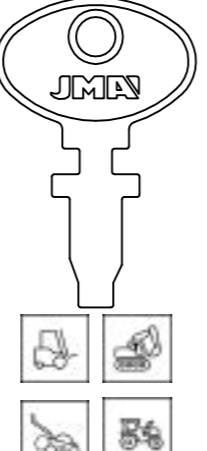
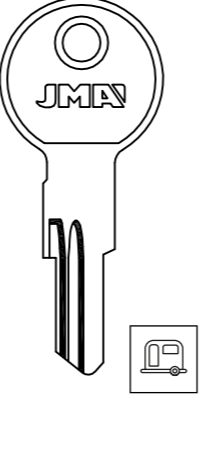
 <p>BS-7</p>	 <p>BS-8</p>	 <p>BS-9</p>	 <p>CAT-1.P</p>	 <p>CAT-2</p>	 <p>CAT-3</p>
<p>FOR: MERCURY®</p>		<p>FOR: DAF®-MACK®-RENAULT SAVIEM®</p>		<p>FOR: DAF®-MACK®-RENAULT SAVIEM®</p>	

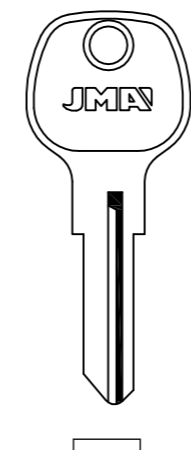
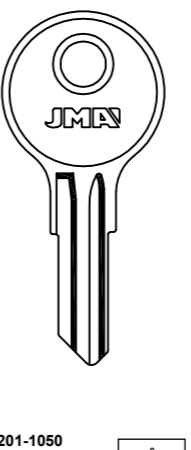
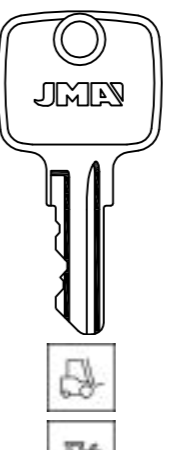
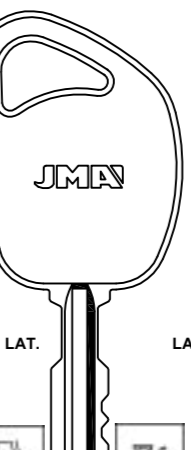
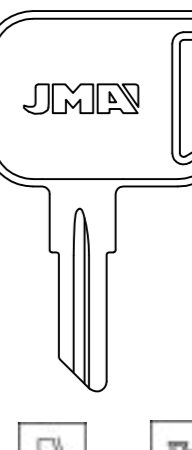
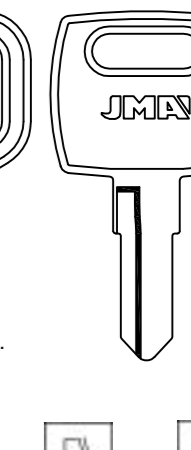
 <p>DAV-1.P</p>	 <p>EU-15.P</p>	 <p>EU-16DP</p>	 <p>FIA-1</p>	 <p>FLO-2D</p>
<p>FOR: HOBBY® -HYMER®</p>		<p>FOR: HOBBY®</p>		<p>FOR: RUNO®</p>

 <p>GH-GX</p>	 <p>GH-HX</p>	 <p>HUD-1</p>	 <p>JD-1</p>	 <p>JD-2</p>	 <p>JD-3D</p>	 <p>JD-4D</p>
<p>FOR: EMKA® -PEROHAUS® FOR: POS® -WECCO®</p>		<p>FOR: DELTA®</p>		<p>FOR: DELTA®</p>		

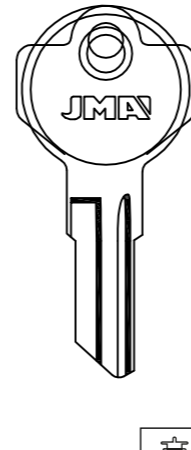
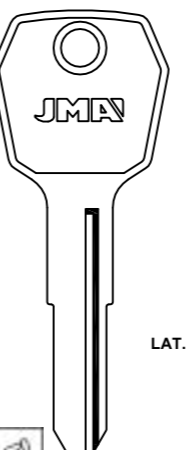
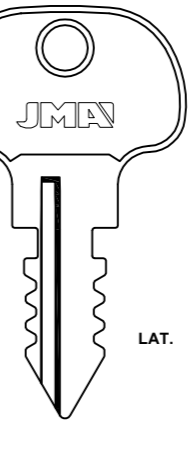
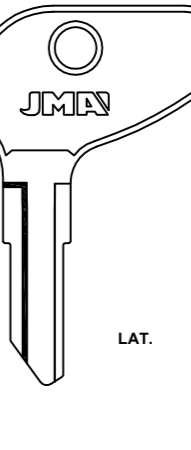
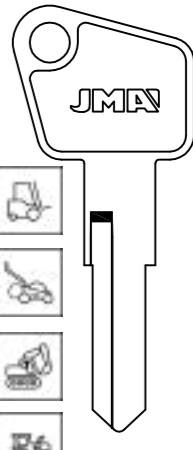
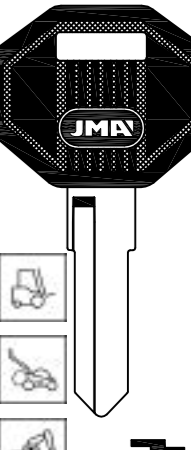
 <p>KEN-1</p>	 <p>KOM-1</p>	 <p>KUB-1D</p>	 <p>KUB-2D</p>	 <p>MERI-1D</p>	 <p>MERI-2D.P</p>
<p>FOR: BASCO®-BRIGGS&STRATTON® FOR: YALE®</p>		<p>FOR: MAHINDRA® -MITSUBISHI®</p>		<p>FOR: MAHINDRA® -MITSUBISHI®</p>	

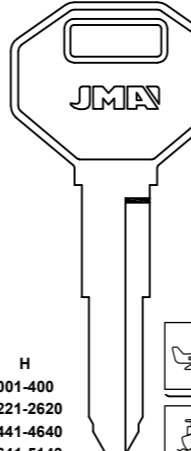
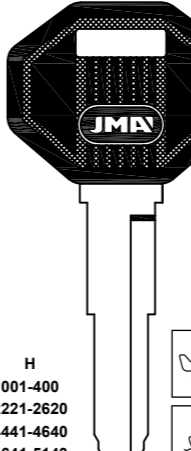
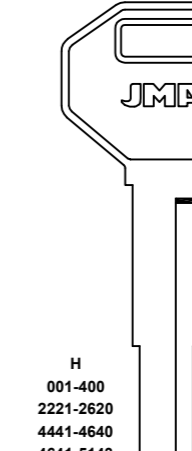
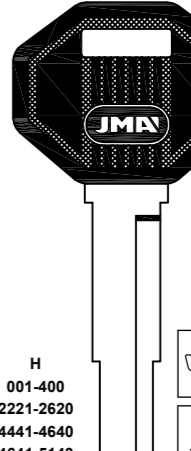
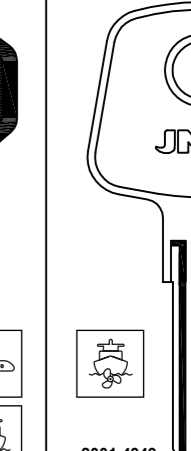
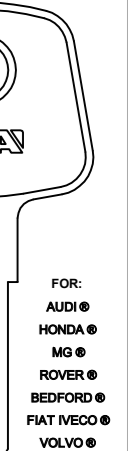
 <p>MIT-11</p>	 <p>MIT-1D</p>	 <p>MIT-11.P</p>	 <p>MIT-1D.P</p>	 <p>MIT-21</p>	 <p>MIT-2D</p>	<p>MIT-21.P</p>	<p>MIT-2D.P</p>	<p>NE-1</p>	<p>NE-1D</p>
<p>FOR: CHRYSLER® -HOLDEN® -ISUZU® -MITSUBISHI®</p>		<p>FOR: CHRYSLER® -GM® -HYUNDAI® -ISUZU® FOR: MITSUBISHI® -SUZUKI®</p>		<p>FOR: CHRYSLER® -GM® -HYUNDAI® -ISUZU® FOR: MITSUBISHI® -SUZUKI®</p>		<p>FOR: CLAUSSOR®</p>			

Concerning the marks and commercial denominations see legal warning.
 Concerniente a las marcas y denominaciones comerciales ver aviso legal.
 Marka eta izendapen komertzialiei dagokienez, ikus lege-oharra.
 Concernant les marques et dénominations commerciales voir la note dans l'index.

JMA Opening the future

JMA Opening the future

Beziehen auf die Marke und Handelsname sehen sie die Notiz im Impressum.
 Relativamente às marcas e denominações comerciais, ver aviso legal.
 Jeśli chodzi o znaki i nazwy handlowe, patrz Informacje prawne.

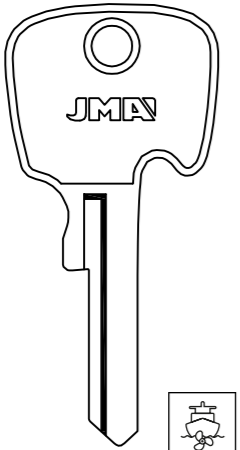
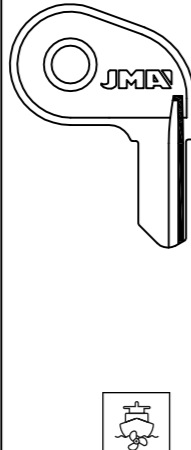
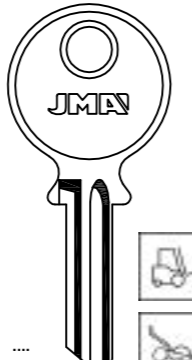
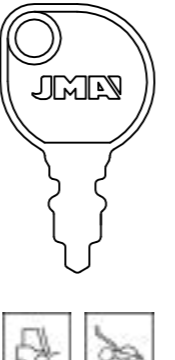
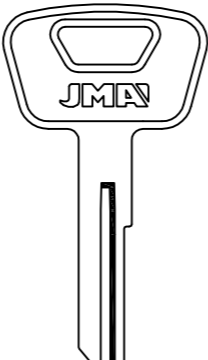

 <p>FOR: AUDI® HONDA® MG® ROVER® BEDFORD® FIAT IVECO® VOLVO®</p> <p>...2001-4949 GM ...2001-3000</p> <p>NE-1.P</p> <p>FOR: CLAUSOR®</p>	 <p>FOR: AUDI® HONDA® MG® ROVER® BEDFORD® FIAT IVECO® VOLVO®</p> <p>N....1 AL 5</p> <p>NE-1D.P</p> <p>FOR: BOMORO® - BOSCH®</p>	 <p>FOR: ERINRUDE®</p> <p>PLL-1</p>	 <p>1001-1052 7200-7399</p> <p>PRE-1</p> <p>FOR: FIAT IVECO® - MAGIRUS DEUTZ®</p>	 <p>6,2 1.82</p> <p>TEU-1</p> <p>FOR: INDAK®</p>	 <p>11121-15543 51112-55424</p> <p>5....</p> <p>TOYO-25</p>
---	--	--	--	---	--

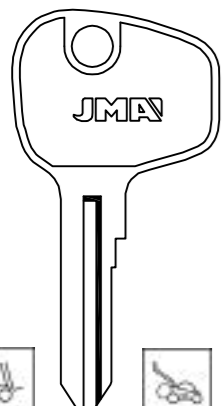
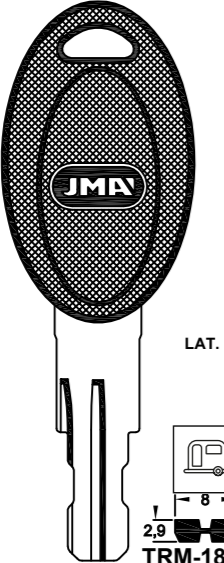
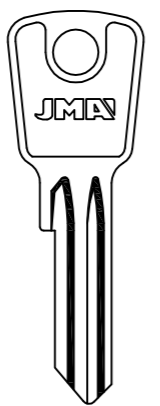
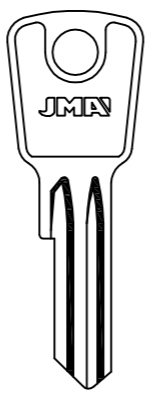
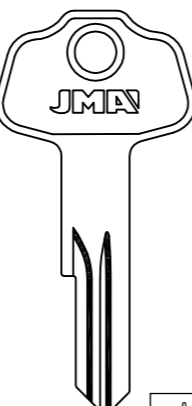
 <p>TOYO-27</p> <p>FOR: HINO®</p>	 <p>LAT.</p> <p>TRM-18D.P</p>	 <p>A..... 0 AL 5</p> <p>WAS-71</p> <p>FOR: TOK®</p>	 <p>L..... 0 AL 5</p> <p>WAS-9</p> <p>FOR: TOK WINKHAUS®</p>	 <p>B..... L..... 0 AL 5</p> <p>WST-1D</p>
--	---	--	---	--

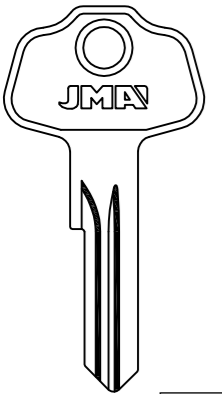
 <p>V.... 1 AL 6</p> <p>WST-2D</p>	<p>FOR: ABUS® BENDIX® CAB® CHICAGO® COLE HERSEE®</p> <p>USA GB</p> <p>ALU.</p> <p>YA-111 YA-11D</p>	<p>FOR: ABUS® BENDIX® CAB® CHICAGO® COLE HERSEE® HELIX® FORT®</p> <p>...500-550</p> <p>YA-27 YA-27D</p>	<p>FOR: ADEMCO® - BENDIX® - CHICAGO® FOR: FORT® - ILLINOIS®</p> <p>YA-37 YA-37D</p>	<p>DC...551-952</p> <p>YA-81 YA-8D</p> <p>YA-91</p>
--	---	---	---	---



BLADES

Espadines
Espadinak

Lames
Schlüsselbarte

Espadilhas
Grotty

VEHICLE KEYS









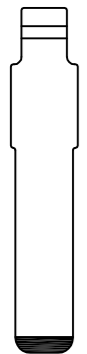

Llaves de vehículos
Ibilgailuen giltzak



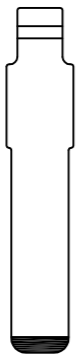



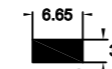

Clés de voitures
Fahrzeugschlüssel

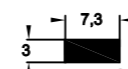







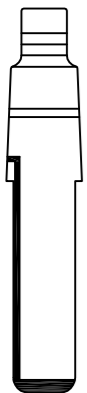

Chaves de automóveis
Klucze do pojazdów



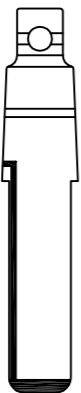





Concerning the marks and commercial denominations see legal warning.
Concerniente a las marcas y denominaciones comerciales ver aviso legal.
Marka eta izendapen komertzialiei dagokienez, ikus lege-oharra.
Concernant les marques et dénominations commerciales voir la note dans l'index.

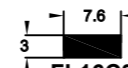



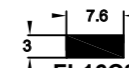

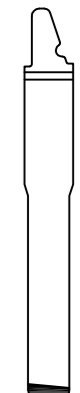

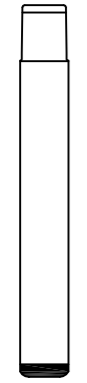

JMA Opening the future

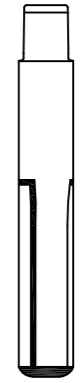





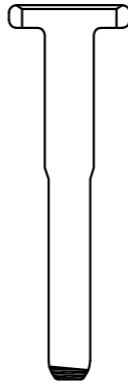

<p>FOR: ABARTH®</p>  <p>ALP.</p>  <p>FI-16C3 FOR: TRW-SIPEA®</p>	<p>FOR: ALFA ROMEO®</p>  <p>ALP.</p>  <p>FI-16C1 FOR: TRW-SIPEA®</p>	<p>FOR: ALFA ROMEO®</p>  <p>ALP.</p>  <p>FI-16C3 FOR: TRW-SIPEA®</p>	<p>FOR: ASTON MARTIN®</p>  <p>ALP.</p> <p>H.... WH.... 0001-3000</p>  <p>OP-WHC1 FOR: HUF®</p>	<p>FOR: AUDI®</p>  <p>ALP.</p>  <p>HU-7C1</p>  <p>HU-4C1 FOR: HUF®</p>
--	--	--	--	--

<p>FOR: CITROEN®</p>  <p>ALP.</p>  <p>PEU-1C1 FOR: U-SHIN®</p>	<p>FOR: DACIA®</p>  <p>ALP.</p>  <p>DAC-3DC1 FOR: DACIA®</p>				<p>FOR: DACIA®</p>  <p>ALP.</p>  <p>DAC-4DC1 FOR: DACIA® FOR: HUF®</p>	<p>FOR: DACIA®</p>  <p>ALP.</p>  <p>DAC-5C1 FOR: DACIA® FOR: U-SHIN®</p>	<p>FOR: DACIA®</p>  <p>ALP.</p>  <p>DAC-6DC1 FOR: DACIA® FOR: HUF®</p>
--	--	--	--	--	--	--	--

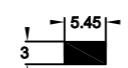
<p>FOR: AUDI®</p>  <p>ALP.</p>  <p>HU-HAAC1 FOR: HUF®</p>			<p>FOR: BUICK®</p>  <p>ALP.</p>  <p>HU-NAAC2 FOR: HUF®</p>	<p>FOR: BUICK®</p>  <p>ALP.</p>  <p>HU-HAAC3 FOR: U-SHIN®</p>	<p>FOR: BUICK®</p>  <p>ALP.</p> <p>Z....1-2000 Z....2001-4000 Z....4001-6000</p>  <p>OP-11C1 FOR: HUF®</p>	<p>FOR: CADILLAC®</p>  <p>ALP.</p> <p>Z....1-2000 Z....2001-4000 Z....4001-6000</p>  <p>OP-11C1 FOR: HUF®</p>
--	--	--	---	--	---	--

<p>FOR: FERRARI®</p>  <p>ALP.</p>  <p>FI-16C3 FOR: TRW-SIPEA®</p>	<p>FOR: FIAT®</p>  <p>ALP.</p>  <p>FI-16C1 FOR: TRW-SIPEA®</p>		<p>FOR: FIAT®</p>  <p>ALP.</p>  <p>FI-16C3 FOR: TRW-SIPEA®</p>	<p>FOR: FORD®</p>  <p>ALP.</p> <p>....1-4000</p>  <p>FO-24C1 FOR: HUF®</p>	<p>FOR: FORD®</p>  <p>ALP.</p> <p>....1-4000</p>  <p>FO-24C2 FOR: HUF®</p>
--	---	--	---	---	---

<p>FOR: CHEVROLET®</p>  <p>ALP.</p> <p>Z....1-2000 Z....2001-4000 Z....4001-6000</p>  <p>OP-11C1 FOR: HUF®</p>	<p>FOR: CHEVROLET®</p>  <p>ALP.</p> <p>H.... WH.... 0001-3000</p>  <p>OP-WHC1 FOR: HUF®</p>	<p>FOR: CITROEN®</p>  <p>ALP.</p> <p>.....1-2-3-4-Q-5-6-7-8-HA-B-C-D-E-F</p>  <p>CIT-1C1 FOR: U-SHIN®</p>		<p>FOR: CITROEN®</p>  <p>ALP.</p>  <p>FI-16C1 FOR: TRW-SIPEA®</p>	<p>FOR: CITROEN®</p>  <p>ALP.</p>  <p>FI-16C3 FOR: TRW-SIPEA®</p>
--	---	---	--	---	---

<p>FOR: FORD®</p>  <p>ALP.</p> <p>....1-4000</p>  <p>FO-24C3 FOR: HUF®</p>			<p>FOR: FORD®</p>  <p>ALP.</p> <p>....1-4000</p>  <p>FO-24C8 FOR: HUF®</p>	<p>FOR: FORD®</p>  <p>ALP.</p> <p>....1-4000</p>  <p>FO-24C9 FOR: HUF® FOR: WITTE®</p>	<p>FOR: GMC®</p>  <p>ALP.</p> <p>Z....1-2000 Z....2001-4000 Z....4001-6000</p>  <p>OP-11C1 FOR: HUF®</p>	<p>FOR: HOLDEN®</p>  <p>ALP.</p> <p>Z....1-2000 Z....2001-4000 Z....4001-6000</p>  <p>OP-11C1 FOR: HUF®</p>
--	--	--	--	--	--	---

Concerning the marks and commercial denominations see legal warning.
 Concerniente a las marcas y denominaciones comerciales ver aviso legal.
 Marka eta izendapen komertzialiei dagokienez, ikus lege-oharra.
 Concernant les marques et dénominations commerciales voir la note dans l'index.



FOR: HOLDEN ®	FOR: LANCIA ®		FOR: NISSAN ®	
ALP.	ALP.	ALP.		
H.... WH.... 0001-3000 OP-WHC1 FOR: HUF ®	 FI-16C1 FOR: TRW-SIPEA ®	 7.6 3 FI-16C3 FOR: TRW-SIPEA ®1-22185 DAT-15C1 FOR: NISSAN ® FOR: VALEO ®1-22185 DAT-15C2 FOR: NISSAN ® FOR: VALEO ®

FOR: OPEL-VAUXHALL ®				
			ALP.	ALP.
 DAC-5C1 FOR: DACIA ® FOR: U-SHIN ®	..1/9.... 1/9....A/Z 1/9....A/Z ..1/9....A/Z ...1/9...A/Z1/9..A/Z1/9..A/Z1/9..A/Z A/Z1/9..A/Z M-N-P-R-S NE-60C1 FOR: NEIMAN ®	..1/9.... 1/9....A/Z 1/9....A/Z ..1/9....A/Z ...1/9...A/Z1/9..A/Z1/9..A/Z1/9..A/Z A/Z1/9..A/Z M-N-P-R-S NE-60C3 FOR: NEIMAN ®	Z....1-2000 Z....2001-4000 Z....4001-6000 OP-11C1 FOR: HUF ®0001-3679 Z....1-2000 Z....2001-4000 Z....4001-6314 6.4 3 OP-11C3 FOR: HUF ®

FOR: OPEL-VAUXHALL ®	FOR: PEUGEOT ®			
ALP.	ALP.			ALP.
H.... WH.... 0001-3000 OP-WHC1 FOR: HUF ®1-2-3-4-Q-5-6-7-8-HA-B-C-D-E-F 7.3 3 CIT-1C1 FOR: U-SHIN ®	 NE-60C2 FOR: NEIMAN ®	..1/9.... 1/9....A/Z 1/9....A/Z ..1/9....A/Z ...1/9...A/Z1/9..A/Z1/9..A/Z1/9..A/Z A/Z1/9..A/Z M-N-P-R-S NE-60C3 FOR: NEIMAN ®	7.3 3 PEU-1C1 FOR: U-SHIN ®

FOR: PEUGEOT ®	FOR: RENAULT ®			
ALP.				
 PEU-2C1 FOR: U-SHIN ®	..1/9.... 1/9....A/Z ..1/9....A/Z ...1/9...A/Z1/9..A/Z1/9..A/Z1/9..A/Z A/Z1/9..A/Z M-N-P-R-S NE-60C2 FOR: NEIMAN ®	..1/9.... 1/9....A/Z 1/9....A/Z ..1/9....A/Z ...1/9...A/Z1/9..A/Z1/9..A/Z1/9..A/Z A/Z1/9..A/Z M-N-P-R-S NE-60C3 FOR: NEIMAN ®	...A/Z 0/9 1-4092 ...A/Z 0/9 5001-9092 ...A/Z 0/9 1-4092 ...A/Z 0/9 5001-9092 VA-61C1 FOR: VACHETTE ®	...A/Z 0/9 1-4092 ...A/Z 0/9 5001-9092 ...A/Z 0/9 1-4092 ...A/Z 0/9 5001-9092 VA-61C2 FOR: VACHETTE ®

FOR: RENAULT ®	FOR: RENAULT DACIA ®		FOR: SEAT ®
			ALP.
...A/Z 0/9 1-4092 ...A/Z 0/9 5001-9092 ...A/Z 0/9 1-4092 ...A/Z 0/9 5001-9092 VA-61C3 FOR: VACHETTE ®	 DAC-3DC1 FOR: DACIA ®	 DAC-4DC1 FOR: DACIA ® FOR: HUF ®	 DAC-6DC1 FOR: DACIA ® FOR: HUF ®









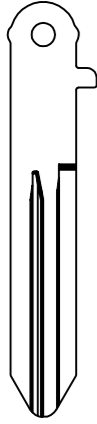
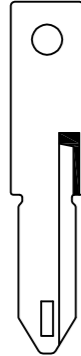

FOR: SKODA ®		FOR: SUBARU ®	
ALP.	ALP.	ALP.	
 HU-7C1 6.65 3 HU-4C1 FOR: HUF ®	 HU-HAAC1 FOR: HUF ®	 HU-HAAC2 HU-NAAC2 FOR: HUF ®	X....1-9000 DAT-6C1 FOR: NISSAN ® FOR: VALEO ®



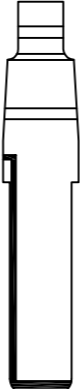



Concerning the marks and commercial denominations see legal warning.
 Concerniente a las marcas y denominaciones comerciales ver aviso legal.
 Marka eta izendapen komertzialiei dagokienez, ikus lege-oharra.
 Concernant les marques et dénominations commerciales voir la note dans l'index.

JMA Opening the future

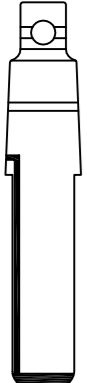
JMA Opening the future

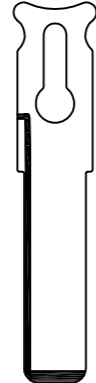
Beziehen auf die Marke und Handelsname sehen sie die Notiz im Impressum.
 Relativamente às marcas e denominações comerciais, ver aviso legal.
 Ješli chodzí o znaki i nazwy handlowe, patrz Informacje prawne.

FOR: SUBARU ®	FOR: VARIOUS ®	FOR: VOLKSWAGEN ®			
					
.....1-22185	..1/9..... 1/9.....A/Z ..1/9.....A/Z ...1/9...A/Z1/9...A/Z1/9..A/Z1/9..A/Z A/Z1/9..A/Z M-N-P-R-S NE-60C1 FOR: NEIMAN ®	HU-7C1	ALP.	ALP.	ALP.
		 6.65 HU-4C1 ¹ FOR: HUF ®			
DAT-15C2 FOR: NISSAN ® FOR: VALEO ®	NE-60C1 FOR: NEIMAN ®	HU-4C1 FOR: HUF ®		HU-HAAC1 FOR: HUF ®	HU-HAAC2 FOR: HUF ®

FOR: VOLKSWAGEN ®		
		
ALP.	ALP.	
		
HU-HAAC3 FOR: U-SHIN ®	HU-HAAC4 FOR: U-SHIN ®	HU-HAAC5 FOR: HUF ®



KRC





VEHICLE KEYS



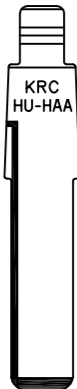

Llaves de vehículos
Ibilgailuen giltzak



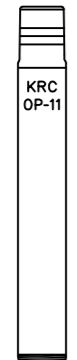

Clés de voitures
Fahrzeugschlüssel



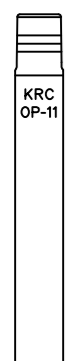

Chaves de automóveis
Klucze do pojazdów

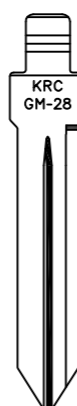



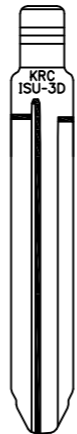

<p>FOR: ACURA (USA)®</p>  <p>LAT.</p> <p>...K001-N718</p> <p>KRCHOND-31 FOR: HONDA®</p>	<p>FOR: AUDI (USA)®</p>  <p>LAT.</p> <p>KRCHU-HAA FOR: HUF®</p>	<p>FOR: AUDI®</p>  <p>LAT.</p> <p>KRCHU-HAA FOR: HUF®</p>	<p>FOR: BUICK®</p>  <p>LAT.</p> <p>H... 1-3988</p> <p>KRCGM-27 FOR: GENERAL MOTORS®</p>	<p>FOR: BUICK®</p>  <p>LAT.</p> <p>H... 1-3988</p> <p>KRCGM-28 FOR: GENERAL MOTORS®</p>
--	--	--	---	--

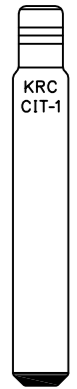
<p>FOR: BUICK®</p>  <p>LAT.</p> <p>KRCGM-37 FOR: GENERAL MOTORS®</p>	<p>FOR: CADILLAC®</p>  <p>LAT.</p> <p>Z... 1-2000 2001-4000 4001-6000</p> <p>KRCOP-11 FOR: HUF®</p>	<p>FOR: CADILLAC®</p>  <p>LAT.</p> <p>H... 1-3988</p> <p>KRCGM-28 FOR: GENERAL MOTORS®</p>	<p>FOR: CHEVROLET®</p>  <p>LAT.</p> <p>KRCGM-37 FOR: GENERAL MOTORS®</p>	<p>FOR: CHEVROLET®</p>  <p>LAT.</p> <p>T-V... 1-1200</p> <p>KRCDAE-4 FOR: DAEWOO®</p>
--	---	--	---	---

<p>FOR: CHEVROLET®</p>  <p>LAT.</p> <p>Z... 1-2000 2001-4000 4001-6000</p> <p>KRCOP-11 FOR: HUF®</p>	<p>FOR: CHEVROLET (USA)®</p>  <p>LAT.</p> <p>T-V... 1-1200</p> <p>KRCDAE-4 FOR: DAEWOO®</p>	<p>FOR: CHEVROLET (USA)®</p>  <p>LAT.</p> <p>H... 1-3988</p> <p>KRCGM-27 FOR: GENERAL MOTORS®</p>	<p>FOR: CHEVROLET (USA)®</p>  <p>LAT.</p> <p>H... 1-3988</p> <p>KRCGM-28 FOR: GENERAL MOTORS®</p>	<p>FOR: CHEVROLET (USA)®</p>  <p>LAT.</p> <p>KRCGM-37 FOR: GENERAL MOTORS®</p>
---	--	--	---	---

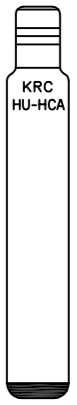
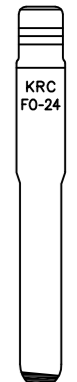
<p>FOR: CHEVROLET (USA)®</p>  <p>LAT.</p> <p>KRCISU-3D FOR: ISUZU®</p>	<p>FOR: CHEVROLET (USA)®</p>  <p>LAT.</p> <p>Z... 1-2000 2001-4000 4001-6000</p> <p>KRCOP-11 FOR: HUF®</p>	<p>FOR: CHRYSLER®</p>  <p>LAT.</p> <p>L... 1-3580</p> <p>KRCCHR-15 FOR: CHRYSLER®</p>	<p>FOR: CHRYSLER (USA)®</p>  <p>LAT.</p> <p>L... 1-3580</p> <p>KRCCHR-15 FOR: CHRYSLER®</p>	<p>FOR: CITROEN®</p>  <p>LAT.</p> <p>.....1-2-3-4-Q-5-6-7-8-HA-B-C-D-E-F</p> <p>KRCCIT-1 FOR: USHIN®</p>
---	---	--	--	---

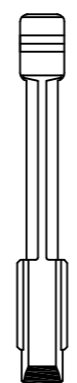
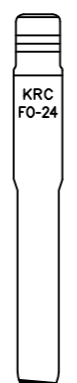
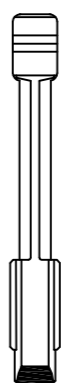
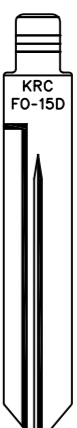







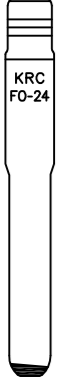

<p>FOR: CITROEN®</p>  <p>LAT.</p> <p>KRCHU-HCA FOR: HUF®</p>	<p>FOR: DODGE®</p>  <p>LAT.</p> <p>L... 1-3580</p> <p>KRCCHR-15 FOR: CHRYSLER®</p>	<p>FOR: DS®</p>  <p>LAT.</p> <p>.....1-2-3-4-Q-5-6-7-8-HA-B-C-D-E-F</p> <p>KRCCIT-1 FOR: USHIN®</p>	<p>FOR: FIAT®</p>  <p>LAT.</p> <p>KRCHU-HCA FOR: HUF®</p>	<p>FOR: FORD®</p>  <p>LAT.</p> <p>.....1-4000</p> <p>KRCFO-24 FOR: HUF®</p>
--	--	---	---	---









<p>FOR: FORD®</p>  <p>LAT.</p> <p>T... 1 AL 4 001-1050</p> <p>KRCFO-6 FOR: HUF®</p>	<p>FOR: FORD (AUS)®</p>  <p>LAT.</p> <p>.....1-4000</p> <p>KRCFO-24 FOR: HUF®</p>	<p>FOR: FORD (AUS)®</p>  <p>LAT.</p> <p>T... 1 AL 4 001-1050</p> <p>KRCFO-6 FOR: HUF®</p>	<p>FOR: FORD (USA)®</p>  <p>LAT.</p> <p>.....X 0001-1706</p> <p>KRCFO-15D FOR: FORD®</p>	<p>FOR: FORD (USA)®</p>  <p>LAT.</p> <p>...A... 101-291 501-579 ...B... 101-332 501-602 ...C... 101-344 501-624 ...D... 101-327 501-602 ...E... 101-296 501-579</p> <p>KRCFO-16 FOR: FORD®</p>
--	--	--	---	---

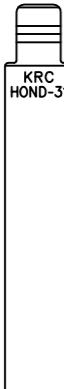







Concerning the marks and commercial denominations see legal warning.
 Concerniente a las marcas y denominaciones comerciales ver aviso legal.
 Marka eta izendapen komertzialiei dagokienez, ikus lege-oharra.
 Concernant les marques et dénominations commerciales voir la note dans l'index.

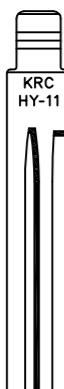

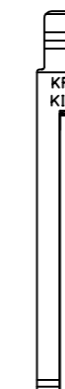









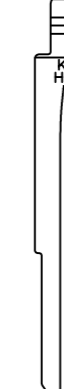
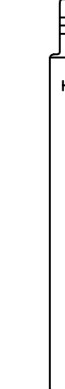
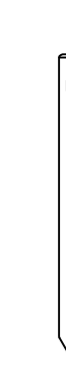





Beziehen auf die marke und handelsname sehen sie die notiz im Impressum.
 Relativamente às marcas e denominações comerciais, ver aviso legal.
 Jeśli chodzi o znaki i nazwy handlowe, patrz Informacje prawne.

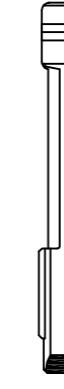

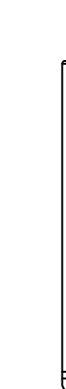





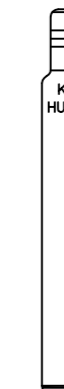

FOR: FORD (USA)®		FOR: GMC®		
 KRC FO-24	 KRC FO-30D	 KRC GM-37	 KRC ISU-3D	 KRC OP-11
LAT.	LAT.	LAT.	LAT.	LAT.
...1-4000  KRCFO-24 FOR: HUF®	 KRCFO-30D FOR: FORD®	 KRCGM-37 FOR: GENERAL MOTORS®	 KRCISU-3D FOR: ISUZU®	Z... 1-2000 2001-4000 4001-6000  KRCOP-11 FOR: HUF®

FOR: HOLDEN®	FOR: HONDA®	FOR:HONDA(AUS)®	FOR: HONDA (USA)®	
 KRC OP-S	 KRC HOND-31	 KRC HOND-31	 KRC HOND-21	 KRC HOND-31
LAT.	LAT.	LAT.	LAT.	LAT.
S... 0001-5200  KRCOP-S FOR: HUF® FOR: YMOS®	...K001-N718  KRCHOND-31 FOR: HONDA®	...K001-N718  KRCHOND-31 FOR: HONDA®	5001-8442  KRCHOND-21 FOR: HONDA®	...K001-N718  KRCHOND-31 FOR: HONDA®

FOR: HUMMER®	FOR: HYUNDAI®			
 KRC GM-37	 KRC HY-11	 KRC HY-4	 KRC HY-6D	 KRC KI-7
LAT.	LAT.	LAT.	LAT.	LAT.
 KRCGM-37 FOR: GENERAL MOTORS®	H...0001-2500 M...0001-2500 P...0001-2500 T...0001-2500 V...1-2500  KRCHY-11 FOR: HYUNDAI® FOR: KIA®	T 0001-1000  KRCHY-4 FOR: HYUNDAI® FOR: KIA®	S... 1-1000  KRCHY-6D FOR: HYUNDAI®	K...0001-2500 P...0001-2500  KRCKI-7 FOR: KIA®

FOR: HYUNDAI®	FOR: HYUNDAI (AUS)®		FOR: HYUNDAI (USA)®	FOR: INFINITI (USA)®
 KRC TOYO-18	 KRC HY-11	 KRC HY-4	 KRC HY-11	 KRC DAT-15
LAT.	LAT.	LAT.	LAT.	LAT.
...1-5000  KRCTOYO-18 FOR: TOYOTA®	H...0001-2500 M...0001-2500 P...0001-2500 T...0001-2500 V...1-2500  KRCHY-11 FOR: HYUNDAI® FOR: KIA®	T 0001-1000  KRCHY-4 FOR: HYUNDAI® FOR: KIA®	H...0001-2500 M...0001-2500 P...0001-2500 T...0001-2500 V...1-2500  KRCHY-11 FOR: HYUNDAI® FOR: KIA®	...1-22185  KRCDAT-15 FOR: NISSAN® FOR: USHIN®

FOR: ISUZU (USA)®	FOR: JAGUAR (USA)®	FOR: JAGUAR®	FOR: JEEP®	FOR: KIA®
 KRC ISU-3D	 KRCFO-6	 KRCFO-6	 KRC CHR-15	 KRC KI-7
LAT.	LAT.	LAT.	LAT.	LAT.
 KRCISU-3D FOR: ISUZU®	T... 1 AL 4 001-1050  KRCFO-6 FOR: HUF® FOR: TIBBE®	T... 1 AL 4 001-1050  KRCFO-6 FOR: HUF® FOR: TIBBE®	L... 1-3580  KRCCHR-15 FOR: CHRYSLER®	K...0001-2500 P...0001-2500  KRCKI-7 FOR: KIA®









FOR: KIA (USA)®		FOR: LANCIA®	FOR:LEXUS (USA)®	FOR: LEXUS®
 KRC HY-11D	 KRC HY-4	 KRC HU-HCA	 KRC TOYO-30	 KRC TOYO-30
LAT.	LAT.	LAT.	LAT.	LAT.
M...1-2500 T...1-2500 WC...1001-3500  KRCHY-11D FOR: HYUNDAI®	T 0001-1000  KRCHY-4 FOR: HYUNDAI® FOR: KIA®	 KRCHU-HCA FOR: HUF®	 KRCTOYO-30 FOR: TOYOTA®	 KRCTOYO-30 FOR: TOYOTA®

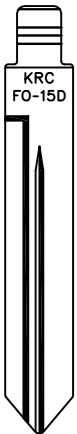
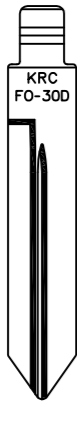

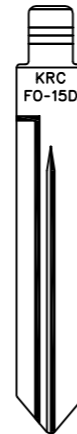





Concerning the marks and commercial denominations see legal warning.
 Concerniente a las marcas y denominaciones comerciales ver aviso legal.
 Marka eta izendapen komertzialiei dagokienez, ikus lege-oharra.
 Concernant les marques et dénominations commerciales voir la note dans l'index.



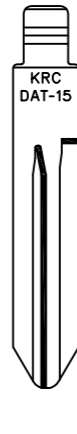
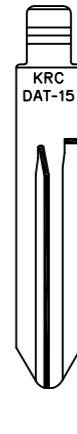







JMA® Opening the future









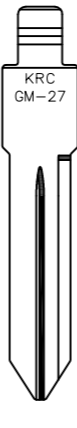

JMA® Opening the future









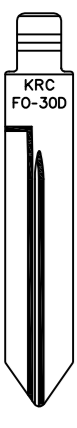

Beziehen auf die marke und handelsname sehen sie die notiz im Impressum.
 Relativamente às marcas e denominações comerciais, ver aviso legal.
 Jeśli chodzi o znaki i nazwy handlowe, patrz Informacje prawne.

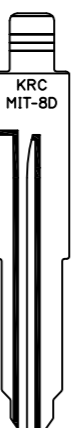







FOR: LINCOLN®		FOR: MAZDA®		FOR: MAZDA (AUS)®	
					
LAT.	LAT.	LAT.	LAT.	LAT.	
...X 0001-1706  KRCFO-15D FOR: FORD®	...X 0001-1706  KRCFO-30D FOR: FORD®	...1-4000  KRCFO-24 FOR: HUF® 10100-12099 20100-23284  KRCMAZ-11D FOR: MAZDA®	...X 0001-1706  KRCFO-15D FOR: FORD®	

FOR: MITSUBISHI (USA)®		FOR: NISSAN®	FOR: NISSAN (AUS)®	FOR: NISSAN (USA)®
				
LAT.	LAT.	LAT.	LAT.	LAT.
F...1-1571  KRCMIT-18 FOR: MITSUBISHI®	30010-32009  KRCMIT-8D FOR: MITSUBISHI®1-22185  KRCDAT-15 FOR: NISSAN® FOR: USHIN®1-22185  KRCDAT-15 FOR: NISSAN® FOR: USHIN®1-22185  KRCDAT-15 FOR: NISSAN® FOR: USHIN®

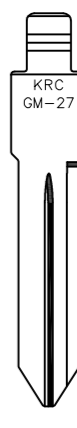
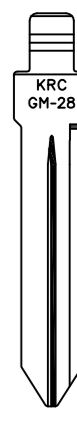
FOR: MAZDA (AUS)®	FOR: MAZDA (USA)®		FOR: MERCURY®	
				
LAT.	LAT.	LAT.	LAT.	LAT.
.... 10100-12099 20100-23284  KRCMAZ-11D FOR: MAZDA®	...X 0001-1706  KRCFO-15D FOR: FORD® 10100-12099 20100-23284  KRCMAZ-11D FOR: MAZDA®	...X 0001-1706  KRCFO-15D FOR: FORD®	...A... 101-291 501-579 ...B... 101-332 501-602 ...C... 101-344 501-624 ...D... 101-327 501-602 ...E... 101-296 501-579  KRCFO-16 FOR: FORD®

FOR: OLDS MOBILE®		FOR: OPEL-VAUXHALL®		
				
LAT.	LAT.	LAT.	LAT.	LAT.
H... 1-3988  KRCGM-27 FOR: GENERAL MOTORS®	H... 1-3988  KRCGM-28 FOR: GENERAL MOTORS®	T-V... 1-1200  KRCDAE-4 FOR: DAEWOO®	Z... 1-2000 2001-4000 4001-6000  KRCOP-11 FOR: HUF®	S... 0001-5200  KRCOP-S FOR: HUF® FOR: YMOS®











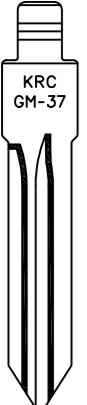

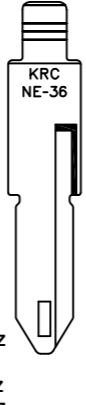
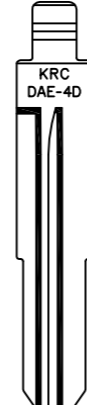





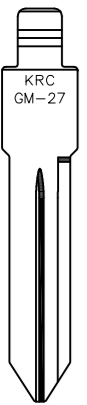
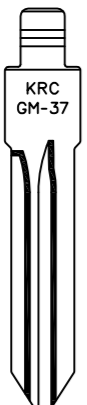

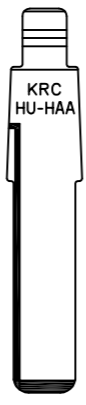



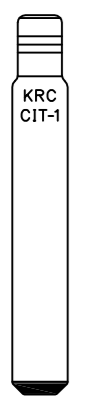

FOR: MERCURY®	FOR: MITSUBISHI®		FOR: MITSUBISHI (AUS)®	FOR: MITSUBISHI (USA)®
				
LAT.	LAT.	LAT.	LAT.	LAT.
 KRCFO-30D FOR: FORD®	E 5001-7679 7001-7700  KRCMIT-12 FOR: MITSUBISHI®	30010-32009  KRCMIT-8D FOR: MITSUBISHI®	E 5001-7679 7001-7700  KRCMIT-12 FOR: MITSUBISHI®	E 5001-7679 7001-7700  KRCMIT-12 FOR: MITSUBISHI®

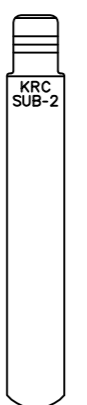











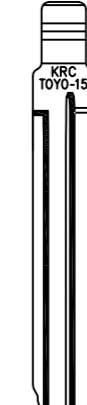

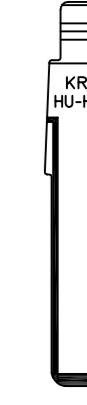

FOR: PEUGEOT®			FOR: PONTIAC®	
				
LAT.	LAT.	LAT.	LAT.	LAT.
.....1-2-3-4-Q-5-6-7-8-HA-B-C-D-E-F  KRCCIT-1 FOR: USHIN®	 KRCHU-HAA FOR: HUF®	 KRCHU-HCA FOR: HUF®	H... 1-3988  KRCGM-27 FOR: GENERAL MOTORS®	H... 1-3988  KRCGM-28 FOR: GENERAL MOTORS®

Concerning the marks and commercial denominations see legal warning.
 Concerniente a las marcas y denominaciones comerciales ver aviso legal.
 Marka eta izendapen komertzialiei dagokienez, ikus lege-oharra.
 Concernant les marques et dénominations commerciales voir la note dans l'index.

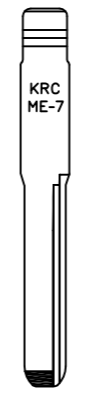

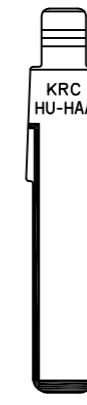
Beziehen auf die marke und handelsname sehen sie die notiz im Impressum.
 Relativamente às marcas e denominações comerciais, ver aviso legal.
 Jeśli chodzi o znaki i nazwy handlowe, patrz Informacje prawne.

FOR: PONTIAC®		FOR: RENAULT®		FOR: SATURN®
				
LAT.	LAT.	LAT.	LAT.	LAT.
				
FOR: GENERAL MOTORS®	FOR: GENERAL MOTORS®	FOR: USHIN®	FOR: NEIMAN®	FOR: DAEWOO®
FOR: SATURN®		FOR: SEAT®	FOR: SEAT (AUS)®	FOR: SKODA®
				
LAT.	LAT.	LAT.	LAT.	LAT.
				
FOR: GENERAL MOTORS®	FOR: GENERAL MOTORS®	FOR: HUF®	FOR: HUF®	FOR: HUF®
FOR: SMART®	FOR: SUBARU®	FOR: SUBARU (AUS)®	FOR: SUBARU (USA)®	FOR: SUZUKI®
				
LAT.	LAT.	LAT.	LAT.	LAT.
				
FOR: USHIN®	FOR: SUBARU®	FOR: SUBARU®	FOR: SUBARU®	FOR: SUZUKI®

FOR: TOYOTA®		FOR: TOYOTA (AUS)®	FOR: TOYOTA (USA)®	FOR: VOLKSWAGEN®
				
LAT.	LAT.	LAT.	LAT.	LAT.
				
FOR: HUF®	FOR: TOYOTA®	FOR: TOYOTA®	FOR: TOYOTA®	FOR: HUF®
FOR: VOLKSWAGEN®	FOR:VOLKSWAGEN(AUS)®	FOR:VOLKSWAGEN(USA)®		
				
LAT.	LAT.	LAT.		
				
FOR: VOLKSWAGEN®	FOR: HUF®	FOR: HUF®		

Concerning the marks and commercial denominations see legal warning.
 Concerniente a las marcas y denominaciones comerciales ver aviso legal.
 Marka eta izendapen komertzialak dagokienez, ikus lege-oharra.
 Concernant les marques et dénominations commerciales voir la note dans l'index.



SNAP LOCK KEYS

Llaves de cierre
Ixte Giltzak

Clés de fermeture
Absperröhne

Chaves de fecho
Klucze Nasadowe

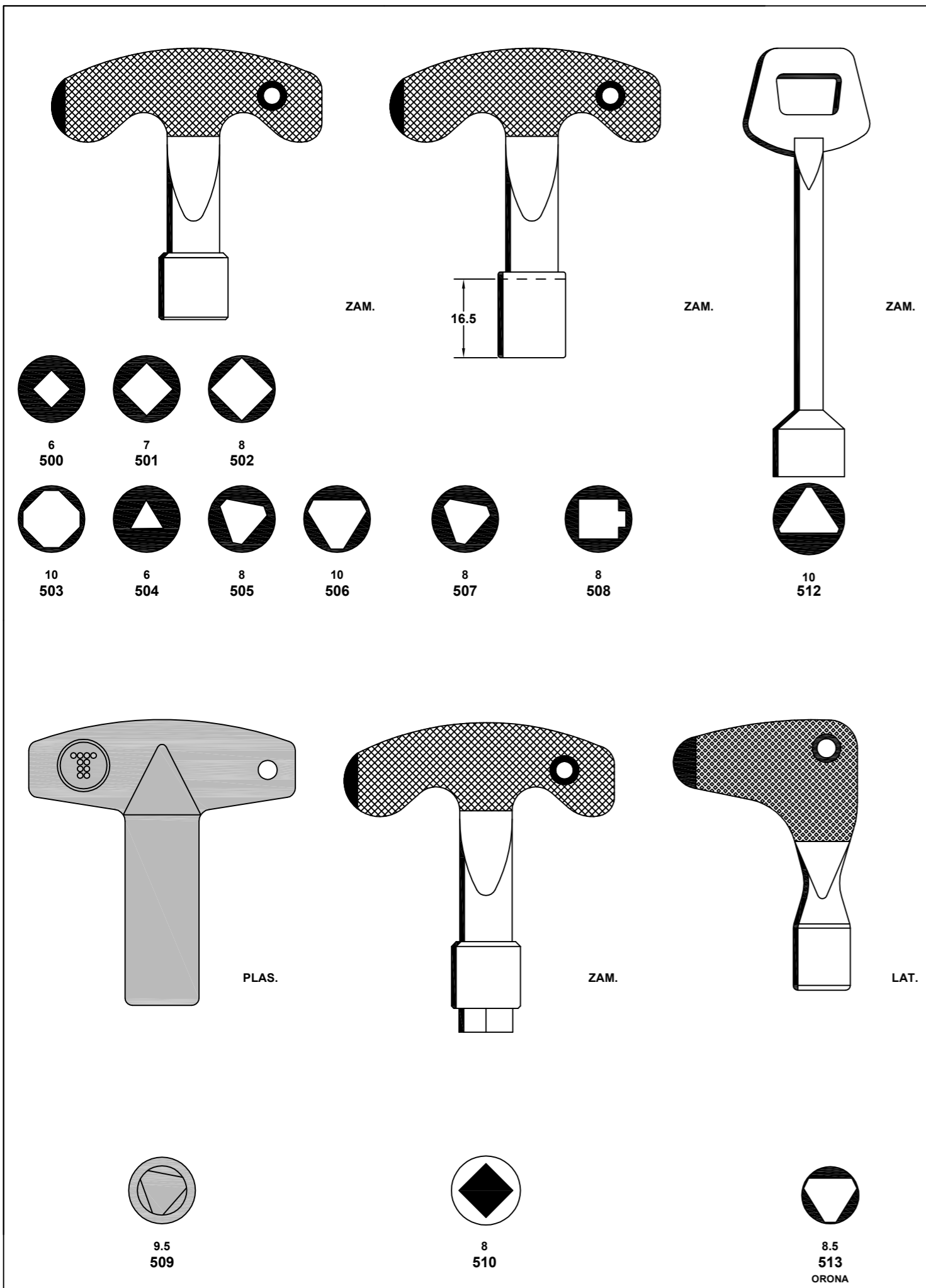

CROSS - SHAPED KEYS

Llaves de cruz
Gurutze motako giltzak

Clés cruciformes
Kreuzbartschlüssel

Chaves de cruz
Klucze krzyżowe

Concerning the marks and commercial denominations see legal warning.
Concerniente a las marcas y denominaciones comerciales ver aviso legal.
Marka eta izendapen komertzialak dagokienez, ikus lege-oharra.
Concernant les marques et dénominations commerciales voir la note dans l'index.

FOR: AGC®		FOR: ALA®		FOR: BLUMA®	
		7	6	7	
		12	14.3	17.6	
AGD-1X CCF3	AGD-2X CCF3	ALA-1X	BLU-1X	BLU-2X	

FOR: BURG®		FOR: CCF®		
7	6			
15	15			
BUR-4X 70mm	BUR-5X 70mm	CCF-1X	CCF-5X	CCF-8X

FOR: BRICARD®		FOR: BURG®		
		6.7	7	6.7
		11.8	11.8	11.8
BRI-1X	BRI-2X	BUR-1X 75mm FOR: TRIOVING®	BUR-2X 90mm FOR: TESA®	BUR-3X 100mm FOR: TESA®

FOR: CCF®		FOR: CIFIAL®	FOR: CRC CAMBOA®	FOR: DEBEAURAIN®
CCF-9X	CCF-10X	CIF-1X CCF4	CRC-1X	DEB-1X

Concerning the marks and commercial denominations see legal warning.
 Concerniente a las marcas y denominaciones comerciales ver aviso legal.
 Marka eta izendapen komertzialiei dagokienez, ikus lege-oharra.
 Concernant les marques et dénominations commerciales voir la note dans l'index.

JMA® Opening the future

JMA® Opening the future

Beziehen auf die marke und handelsname sehen sie die notiz im index.
 Relativamente às marcas e denominações comerciais, ver aviso legal.
 Jeśli chodzi o znaki i nazwy handlowe, patrz Informacje prawne.

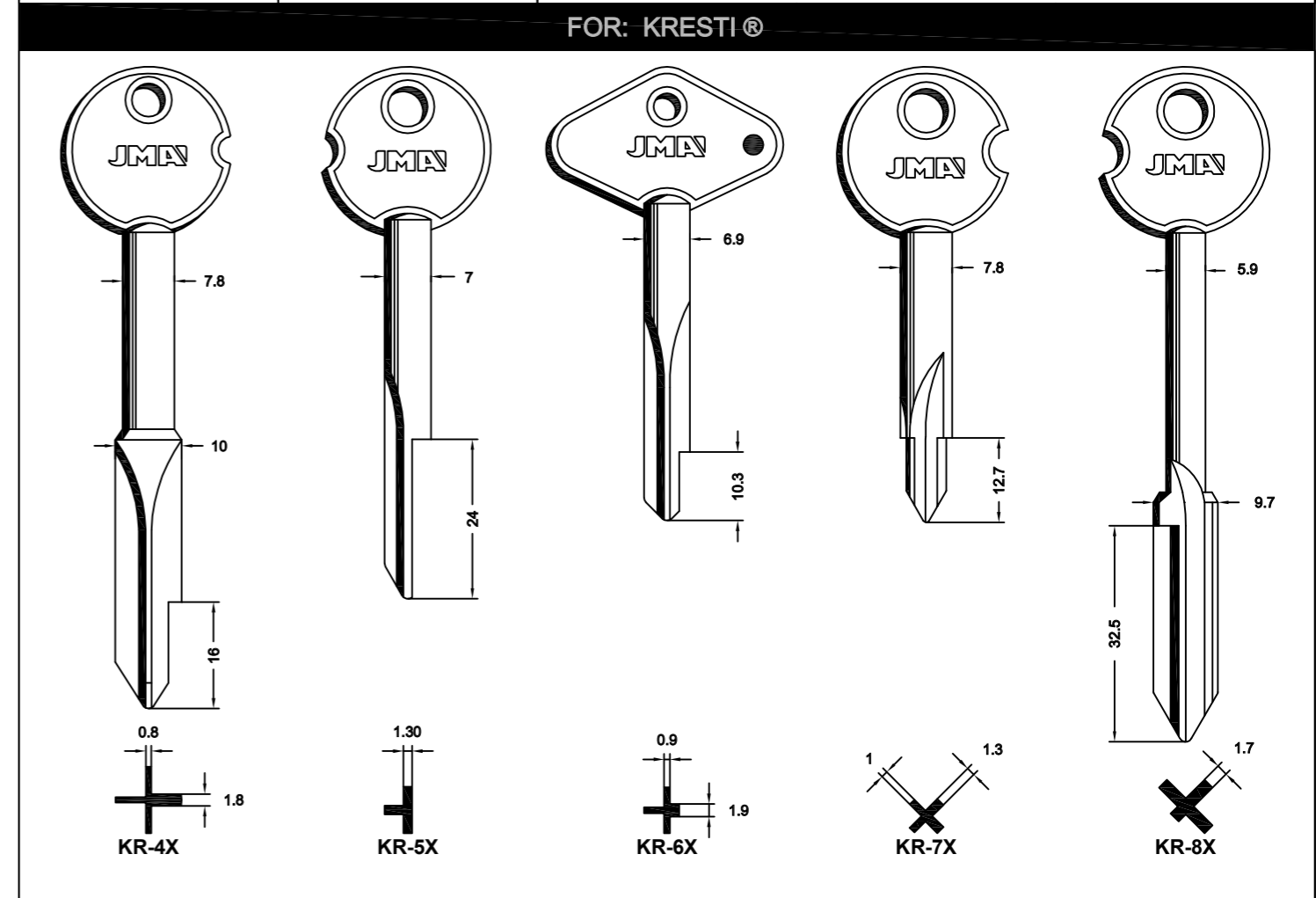
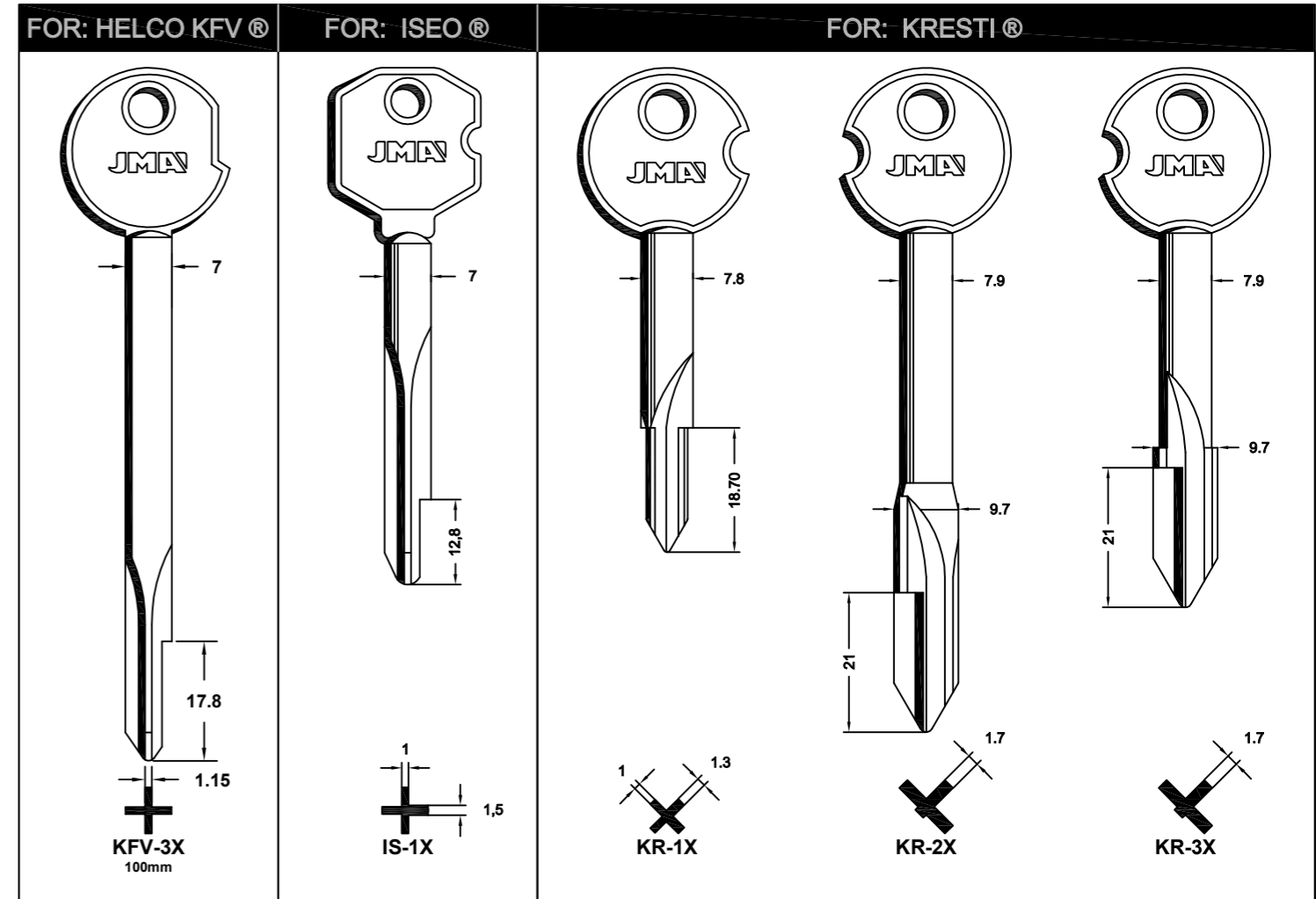
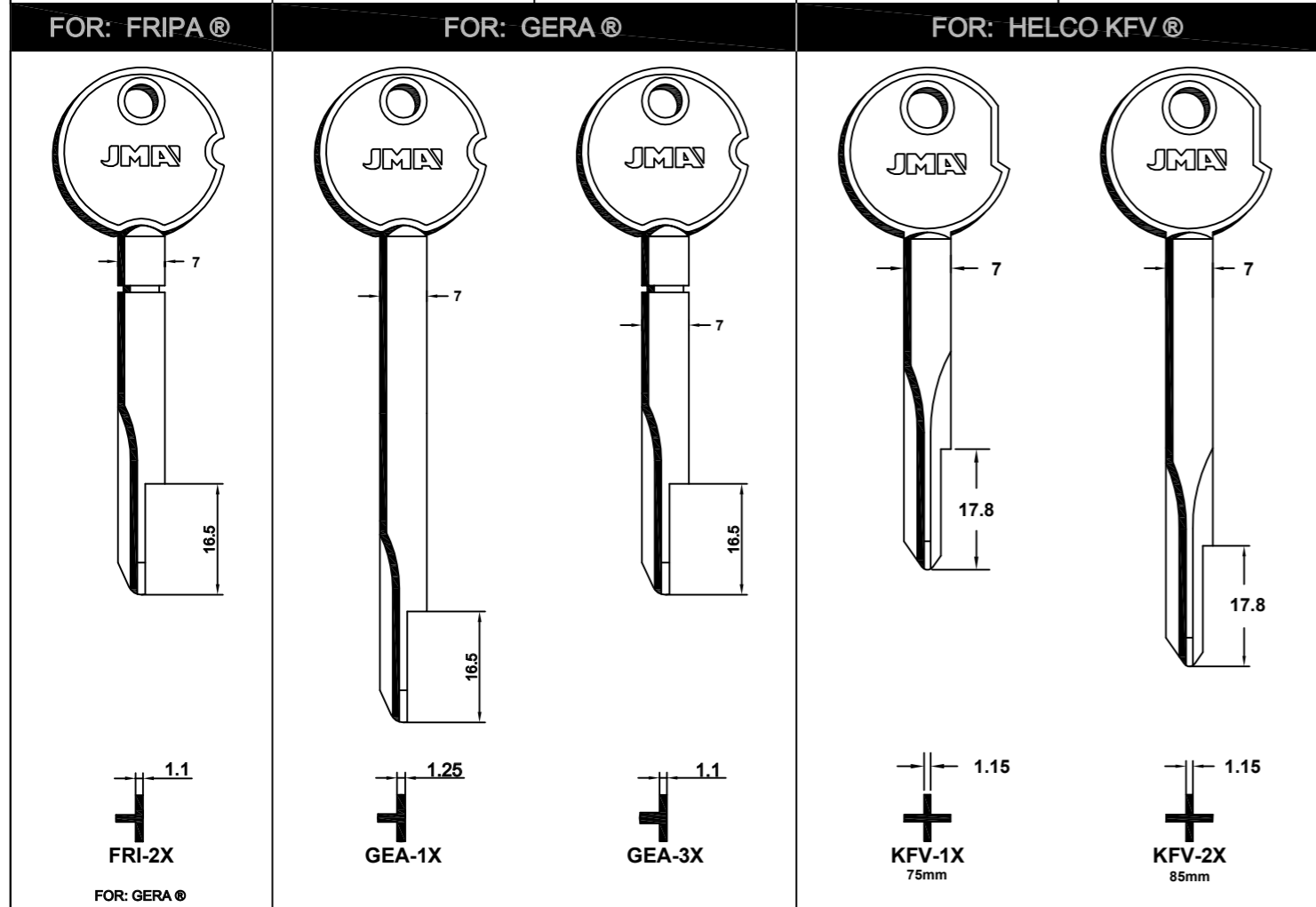
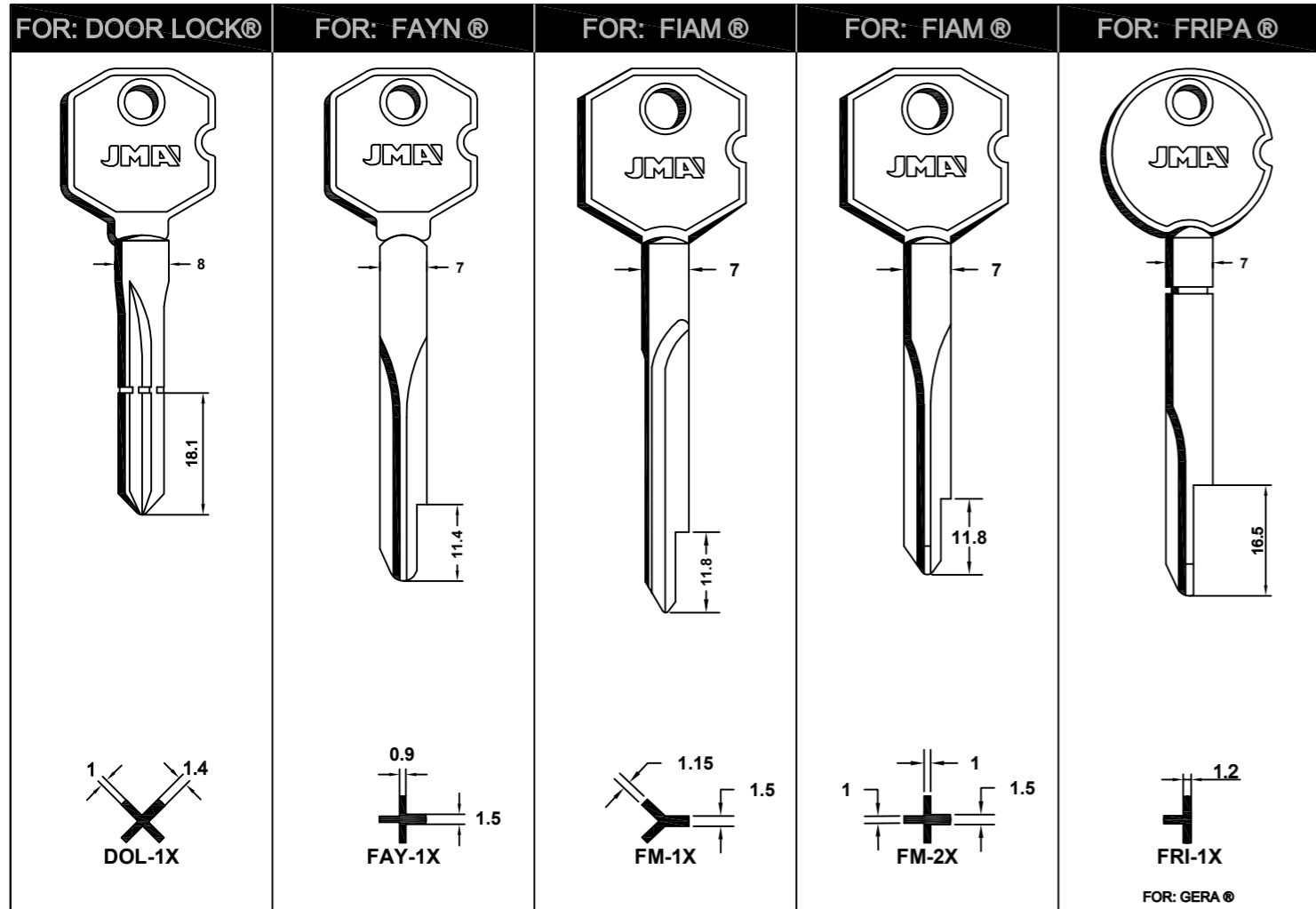

Concerning the marks and commercial denominations see legal warning.
 Concerniente a las marcas y denominaciones comerciales ver aviso legal.
 Marka eta izendapen komertzialiei dagokienez, ikus lege-oharra.
 Concernant les marques et dénominations commerciales voir la note dans l'index.

JMA Opening the future

JMA Opening the future

Beziehen auf die Marke und Handelsname sehen sie die Notiz im Index.
 Relativamente às marcas e denominações comerciais, ver aviso legal.
 Jeśli chodzi o znaki i nazwy handlowe, patrz Informacje prawne.

FOR: KRESTI®

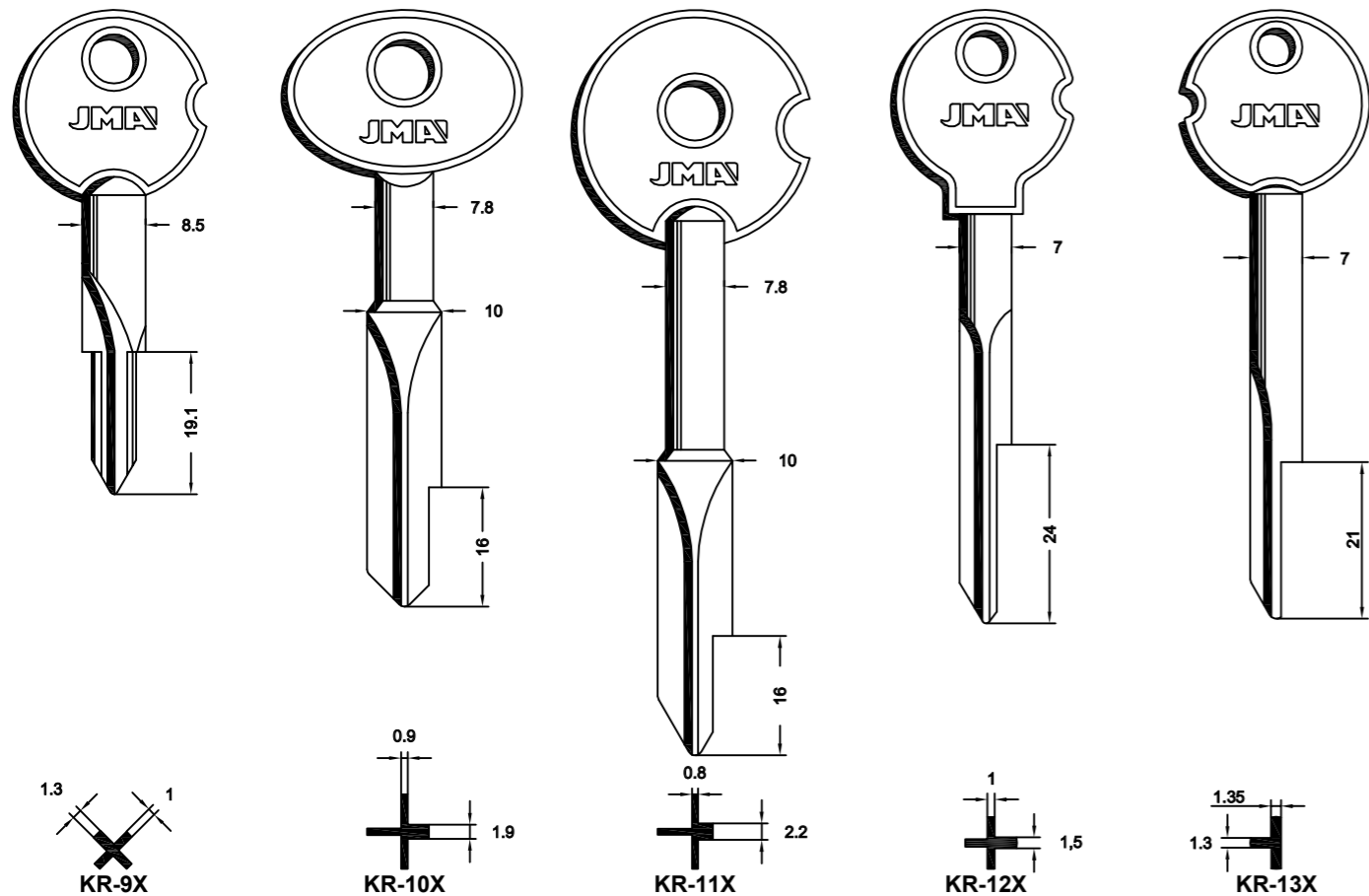

FOR: MAFOR®

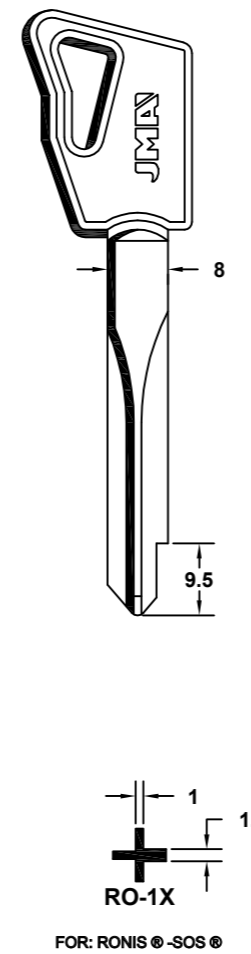

FOR: MINI MOLA®

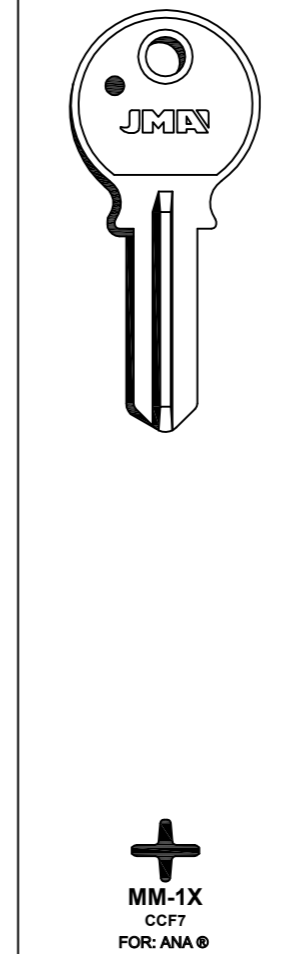

FOR: MOREAUX®

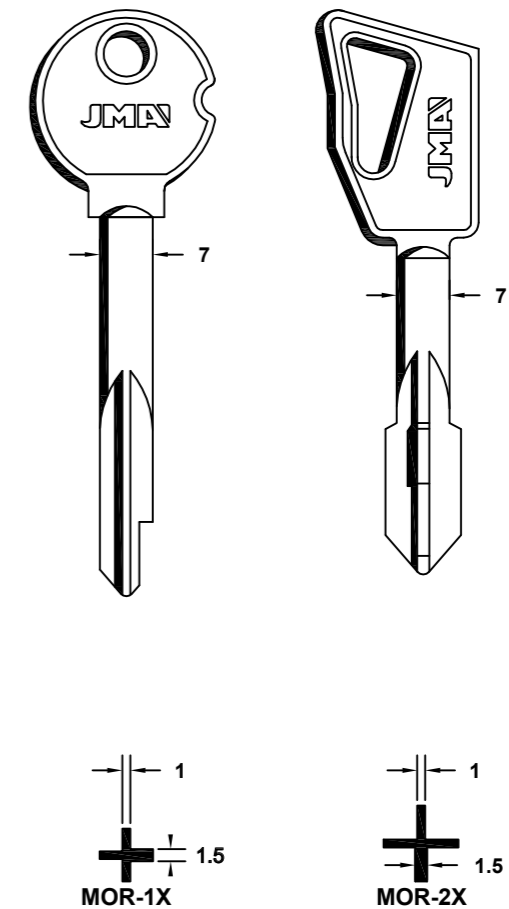

FOR: MSV®

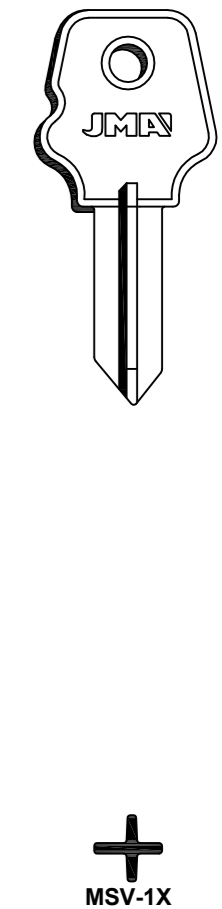

FOR: KRESTI®

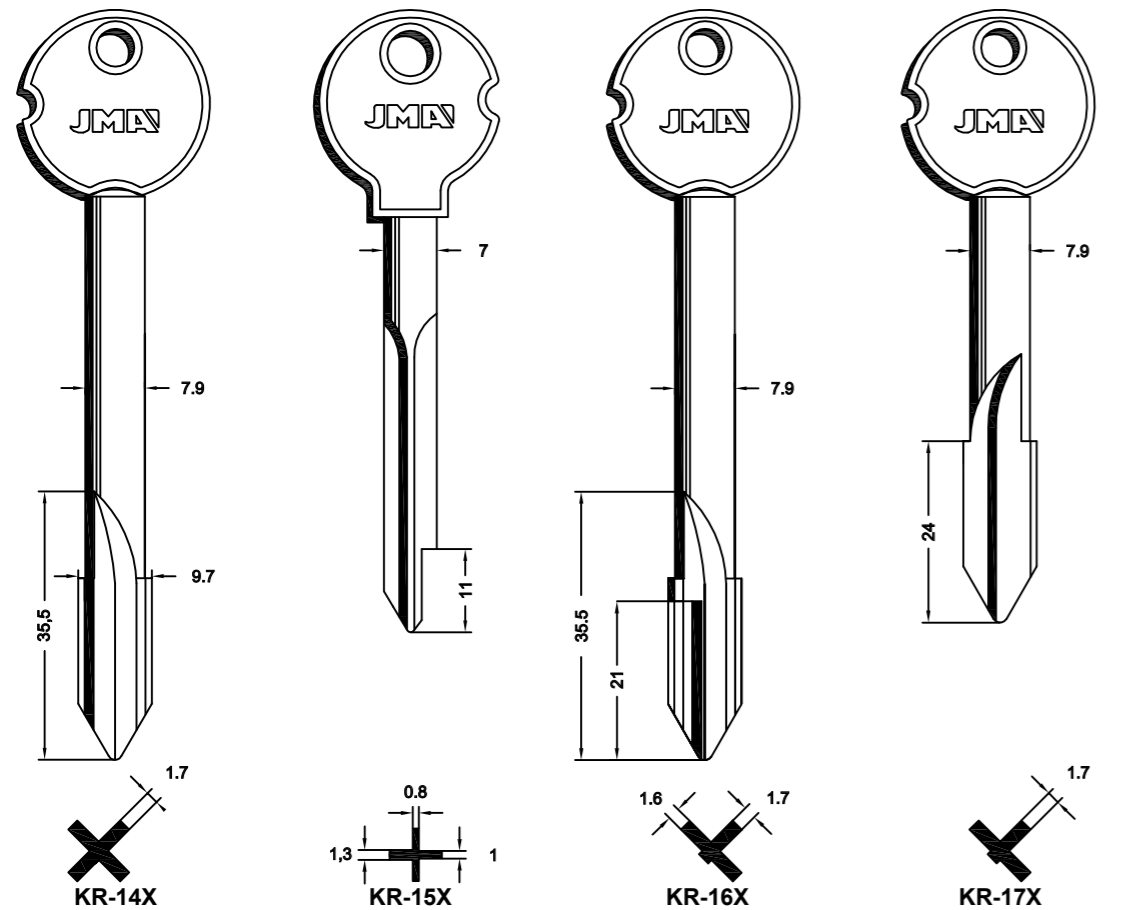

FOR: LOCK-IT®

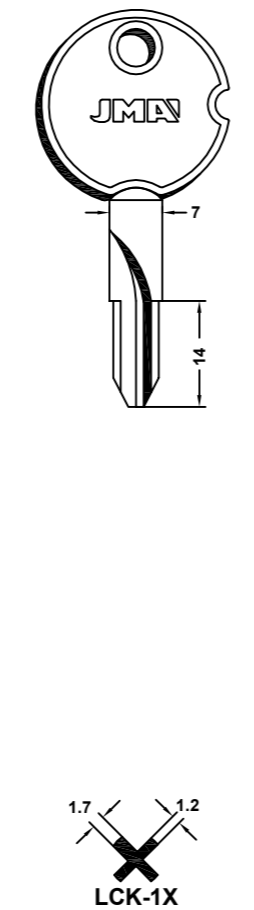

FOR: NABOB®

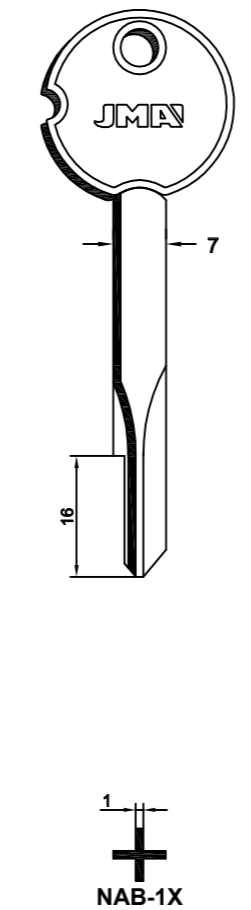

FOR: NEMEF®

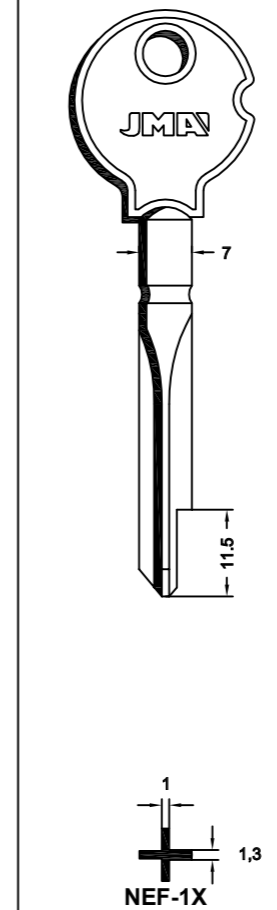

FOR: PAPAIZ®

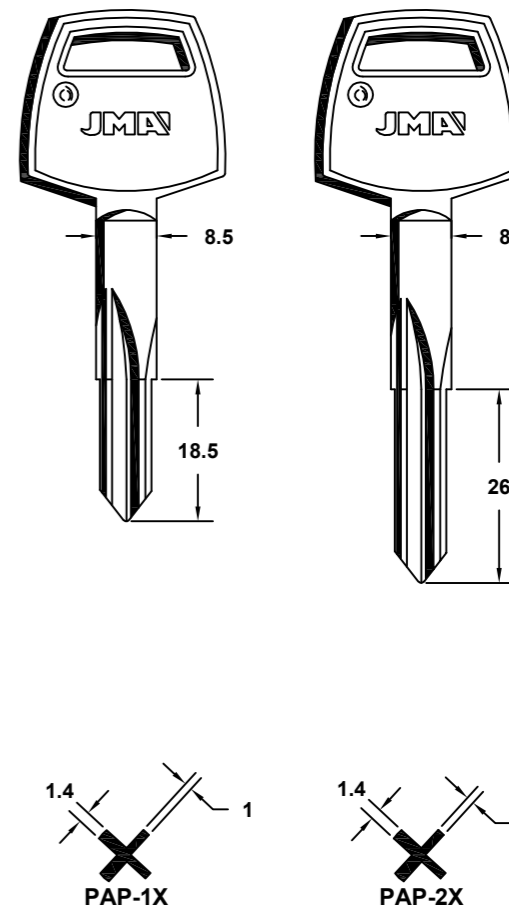

FOR: TUFF®

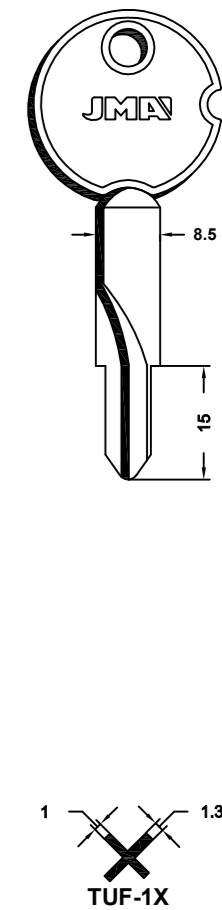

Concerning the marks and commercial denominations see legal warning.
 Concerniente a las marcas y denominaciones comerciales ver aviso legal.
 Marka eta izendapen komertzialiei dagokienez, ikus lege-oharra.
 Concernant les marques et denominations commerciales voir la note dans l'index.

JMA Opening the future

JMA Opening the future

Beziehen auf die marke und handelsname sehen sie die notiz im index.
 Relativamente às marcas e denominações comerciais, ver aviso legal.
 Jeśli chodzi o znaki i nazwy handlowe, patrz Informacje prawne.

K06 / 377

FOR: TUFF®		UNIVERSAL	FOR: YALE BKS®	
TUF-2X	TUF-3X	U-1X	YA-1X 78mm	YA-2X 85mm

FOR: ZEISS IKON®				
ZE-3X 85mm	ZE-4X	ZE-5X 100mm	ZE-6X	ZE-7X 75mm
				ZE-8X 90mm
				ZE-9X 105mm

FOR: YALE BKS®	FOR: YALE®			FOR: ZEISS IKON®
YA-3X 100mm	YA-4X 80mm	YA-5X 95mm	YA-6X 108mm	ZE-1X 70mm
	FOR: CR® -FIAM® -PRAZIS®			ZE-2X

Concerning the marks and commercial denominations see legal warning.
 Concerniente a las marcas y denominaciones comerciales ver aviso legal.
 Marka eta izendapen komertzialiei dagokienez, ikus lege-oharra.
 Concernant les marques et dénominations commerciales voir la note dans l'index.

JMA Opening the future

JMA Opening the future

Beziehen auf die marke und handelsname sehen sie die notiz im index.
 Relativamente às marcas e denominações comerciais, ver aviso legal.
 Jeśli chodzi o znaki i nazwy handlowe, patrz Informacje prawne.





MORTICE KEYS

Llaves de Gorja
Gorja motako giltzak

Clés à gorge
Tresor-Schlüssel

Chaves de gorja
Klucze zasuwowe



STEEL

Acero
Altzairua

Acier
Stahl

Aço
Stal

MORTICE KEYS

Llaves de Gorja
Gorja motako giltzak

Clés à gorge
Tresor-Schlüssel

Chaves de gorja
Klucze zasuwowe

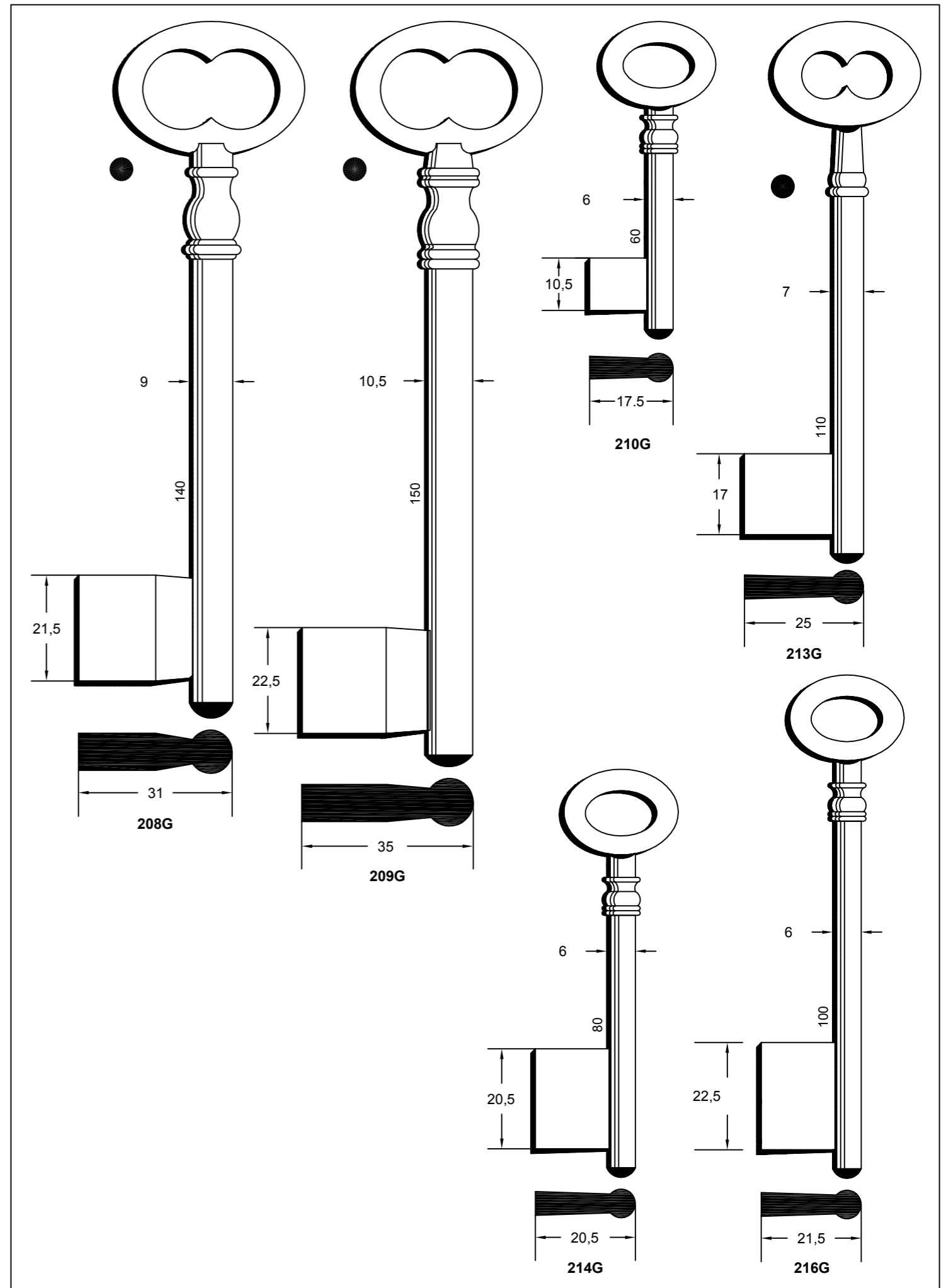
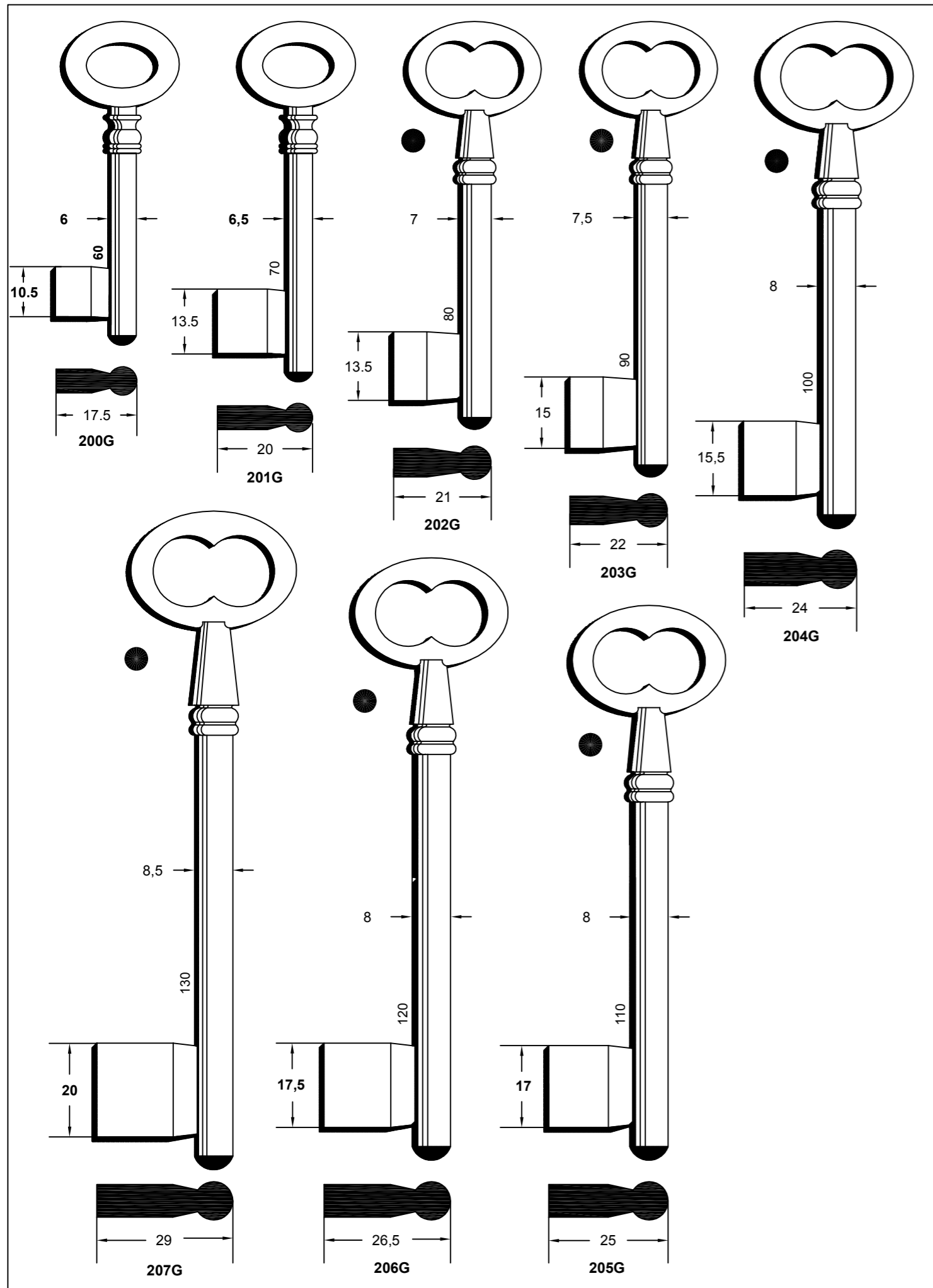

Concerning the marks and commercial denominations see legal warning.
 Concerniente a las marcas y denominaciones comerciales ver aviso legal.
 Marka eta izendapen komertzialei dagokienez, ikus lege-oharra.
 Concernant les marques et dénominations commerciales voir la note dans l'index.

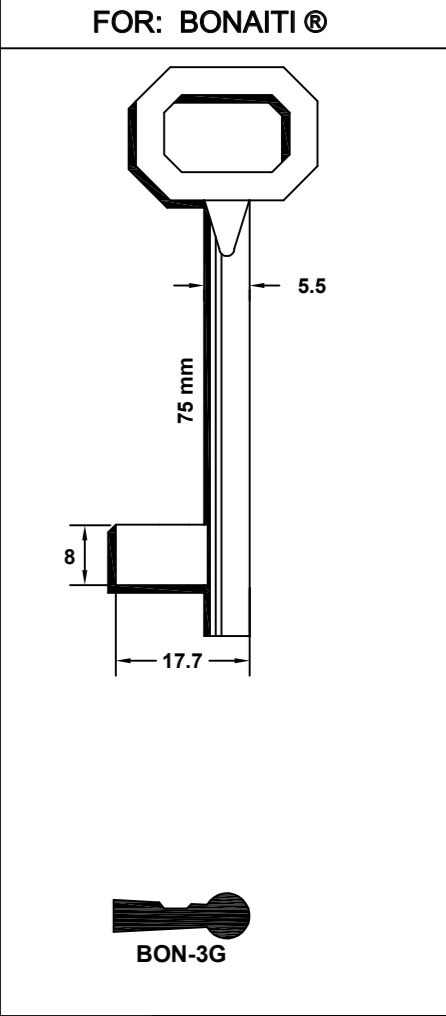
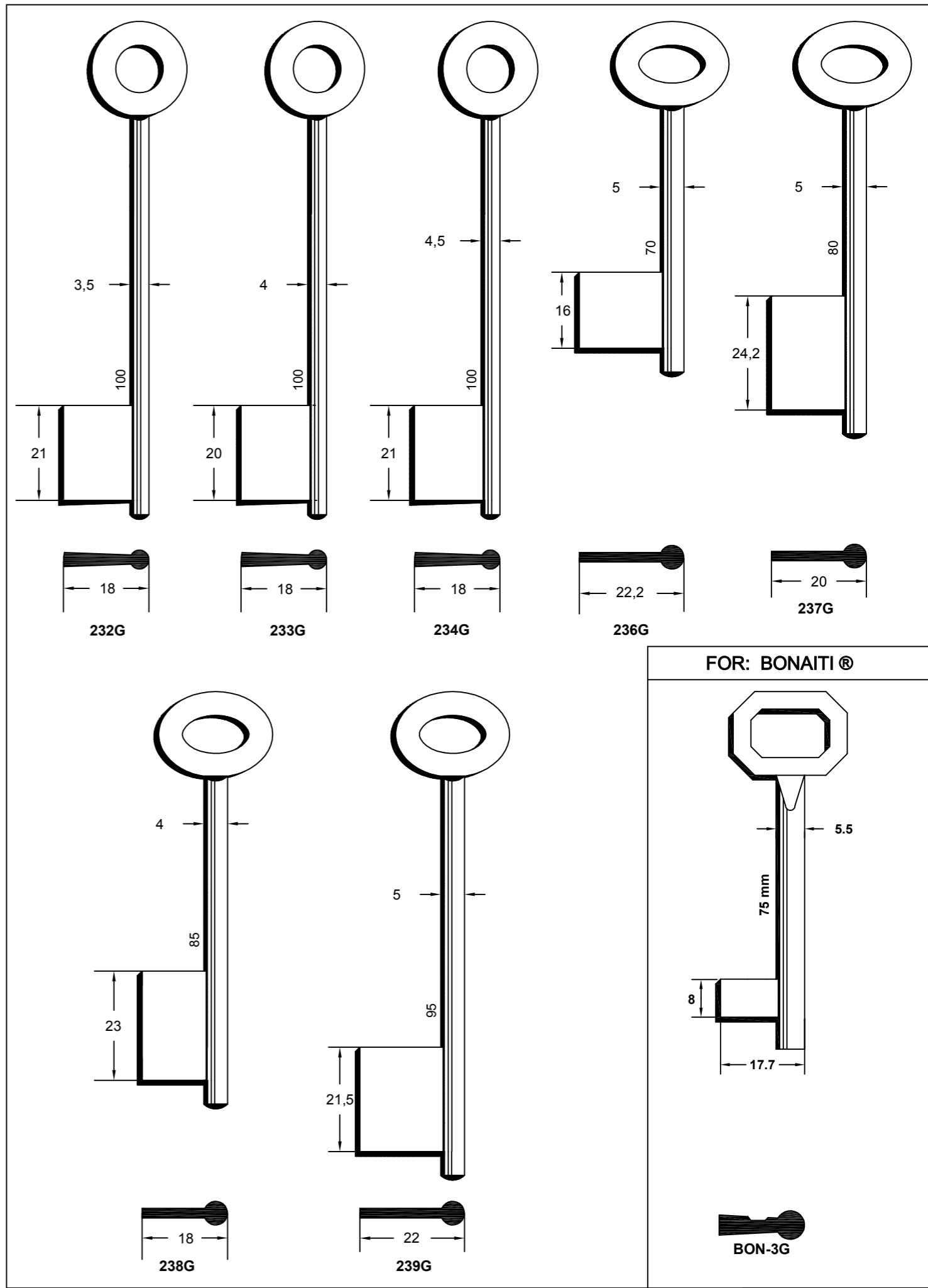
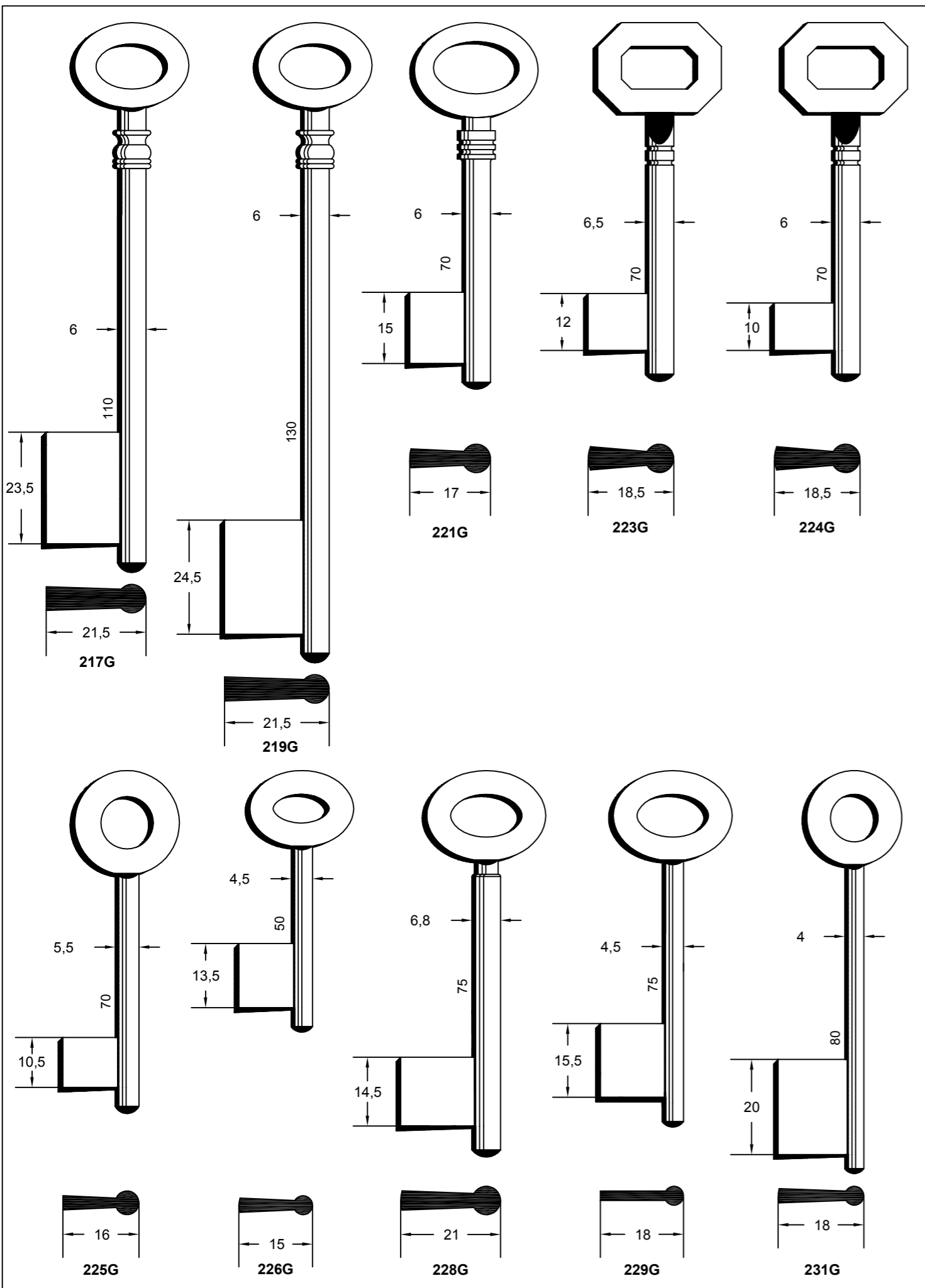

Concerning the marks and commercial denominations see legal warning.
 Concerniente a las marcas y denominaciones comerciales ver aviso legal.
 Marka eta izendapen komertzialiei dagokienez, ikus lege-oharra.
 Concernant les marques et denominations commerciales voir la note dans l'index.

JMA® Opening the future

JMA® Opening the future

Beziehen auf die marke und handelsname sehen sie die notiz im index.
 Relativamente às marcas e denominações comerciais, ver aviso legal.
 Jeśli chodzi o znaki i nazwy handlowe, patrz Informacje prawne.

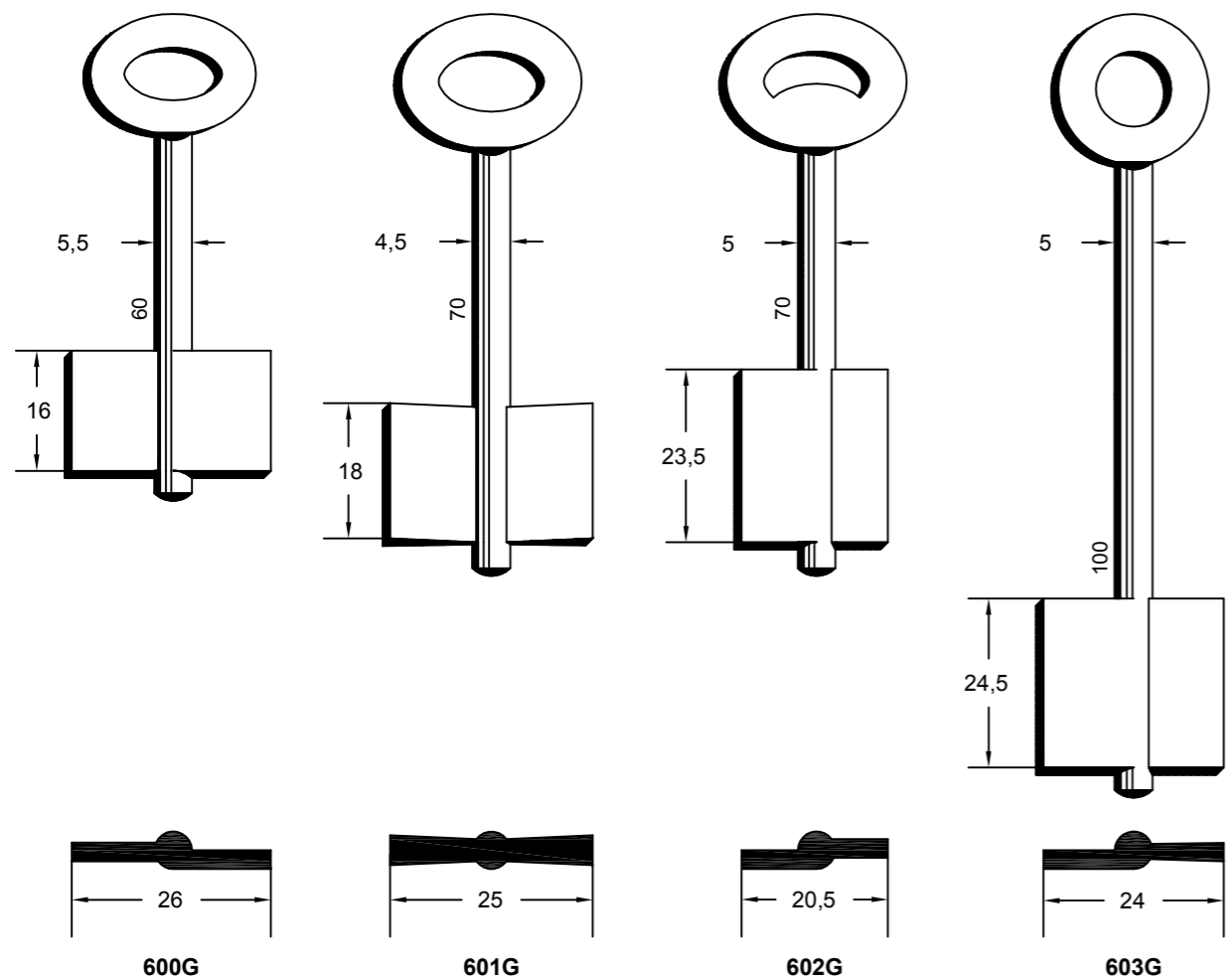

600G

601G

602G

603G

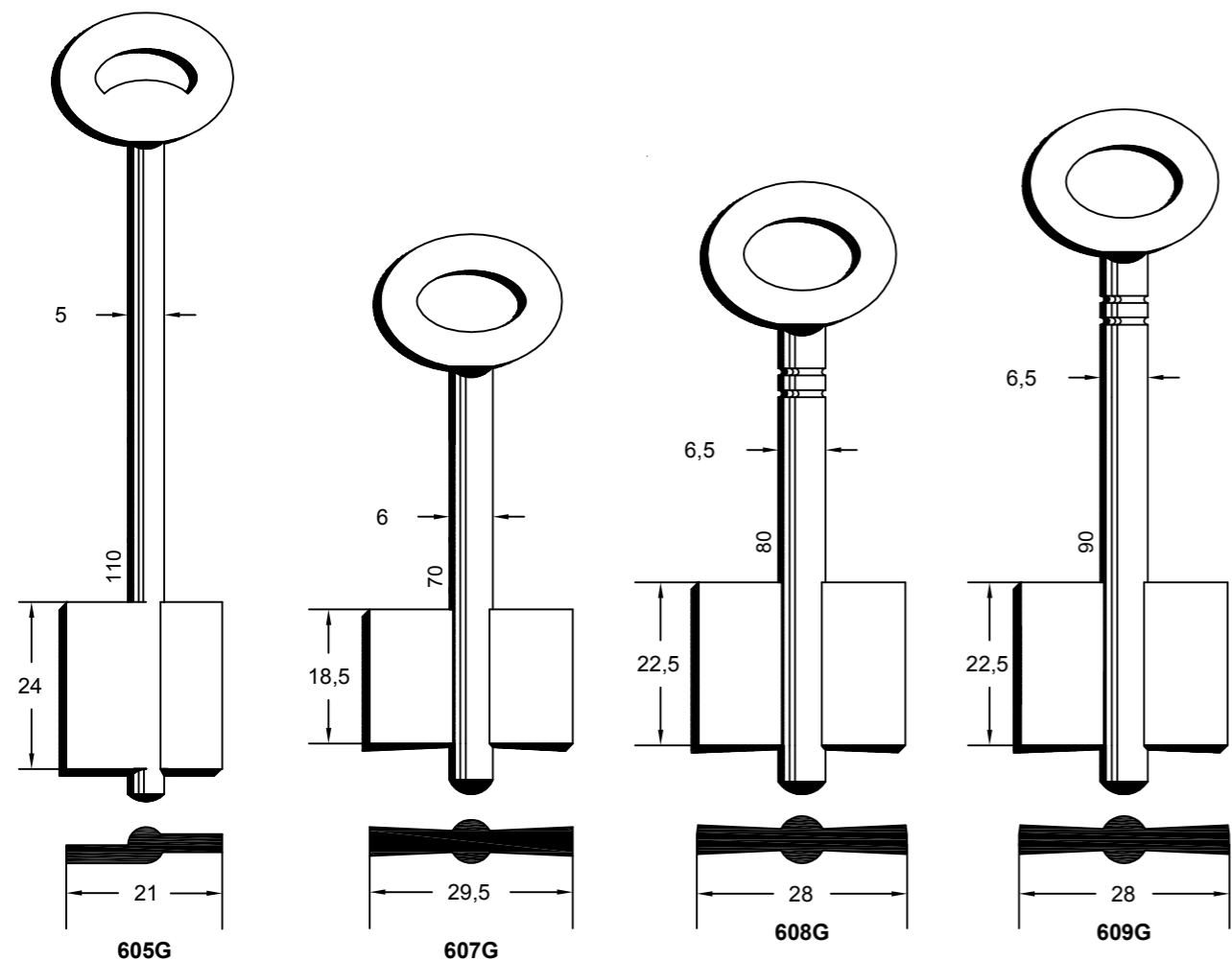

605G

607G

608G

609G

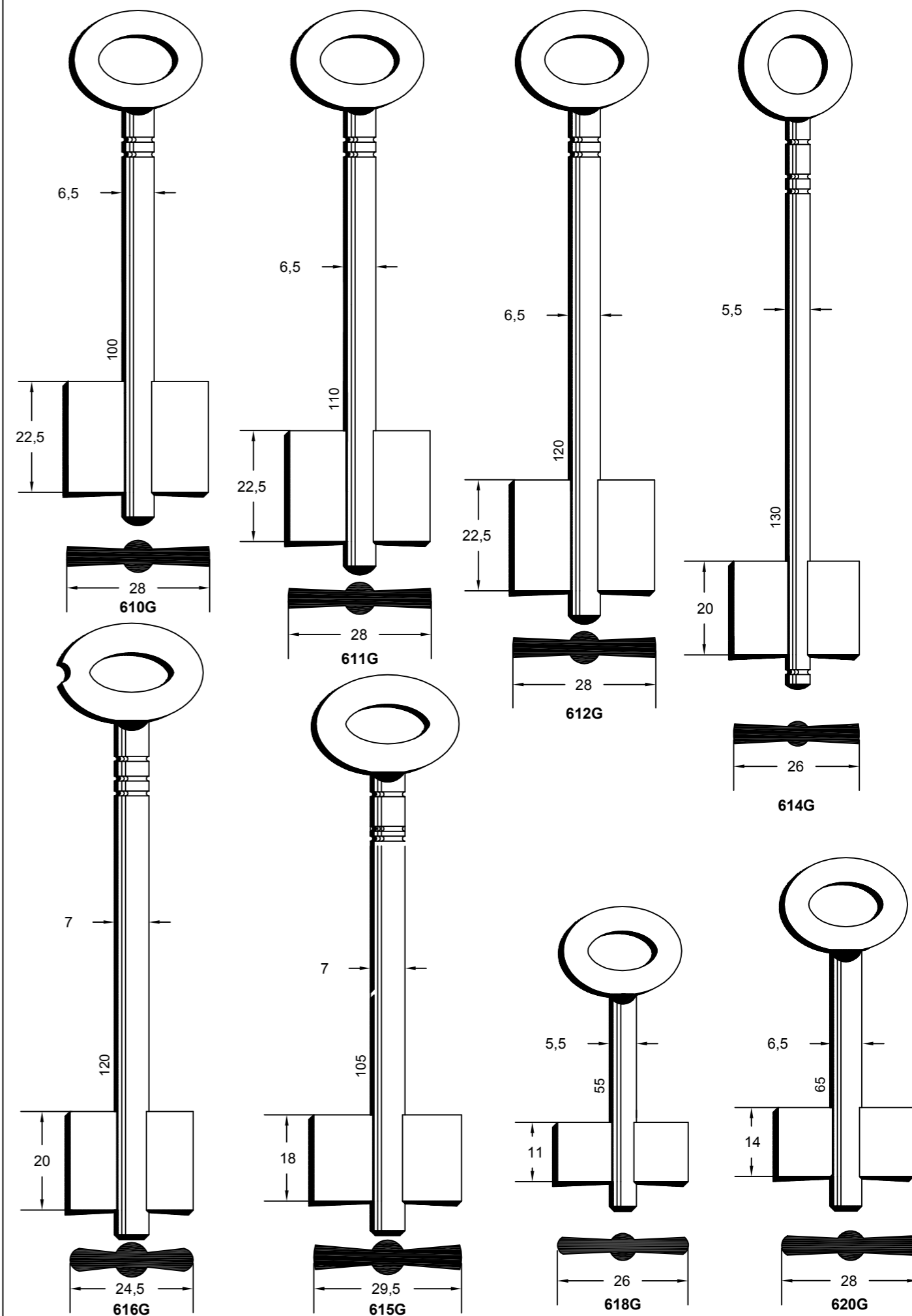

610G

611G

612G

614G

616G

615G

618G

620G

Concerning the marks and commercial denominations see legal warning.
 Concerniente a las marcas y denominaciones comerciales ver aviso legal.
 Marka eta izendapen komertzialei dagokienez, ikus lege-oharra.
 Concernant les marques et denominations commerciales voir la note dans l'index.

JMA Opening the future

JMA Opening the future

Beziehen auf die Marke und Handelsname sehen sie die Notiz im Index.
 Relativamente às marcas e denominações comerciais, ver aviso legal.
 Jeśli chodzi o znaki i nazwy handlowe, patrz Informacje prawne.

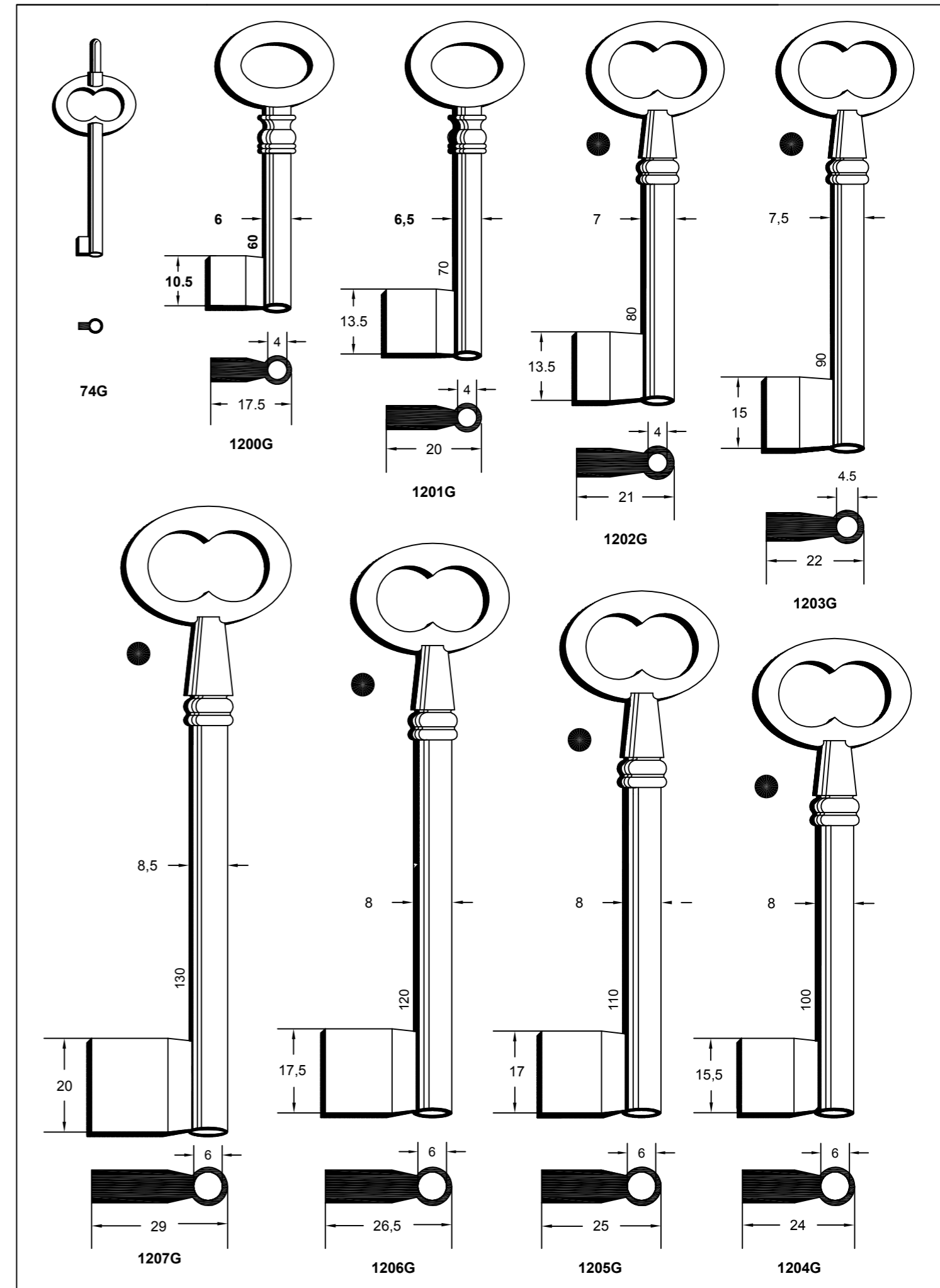
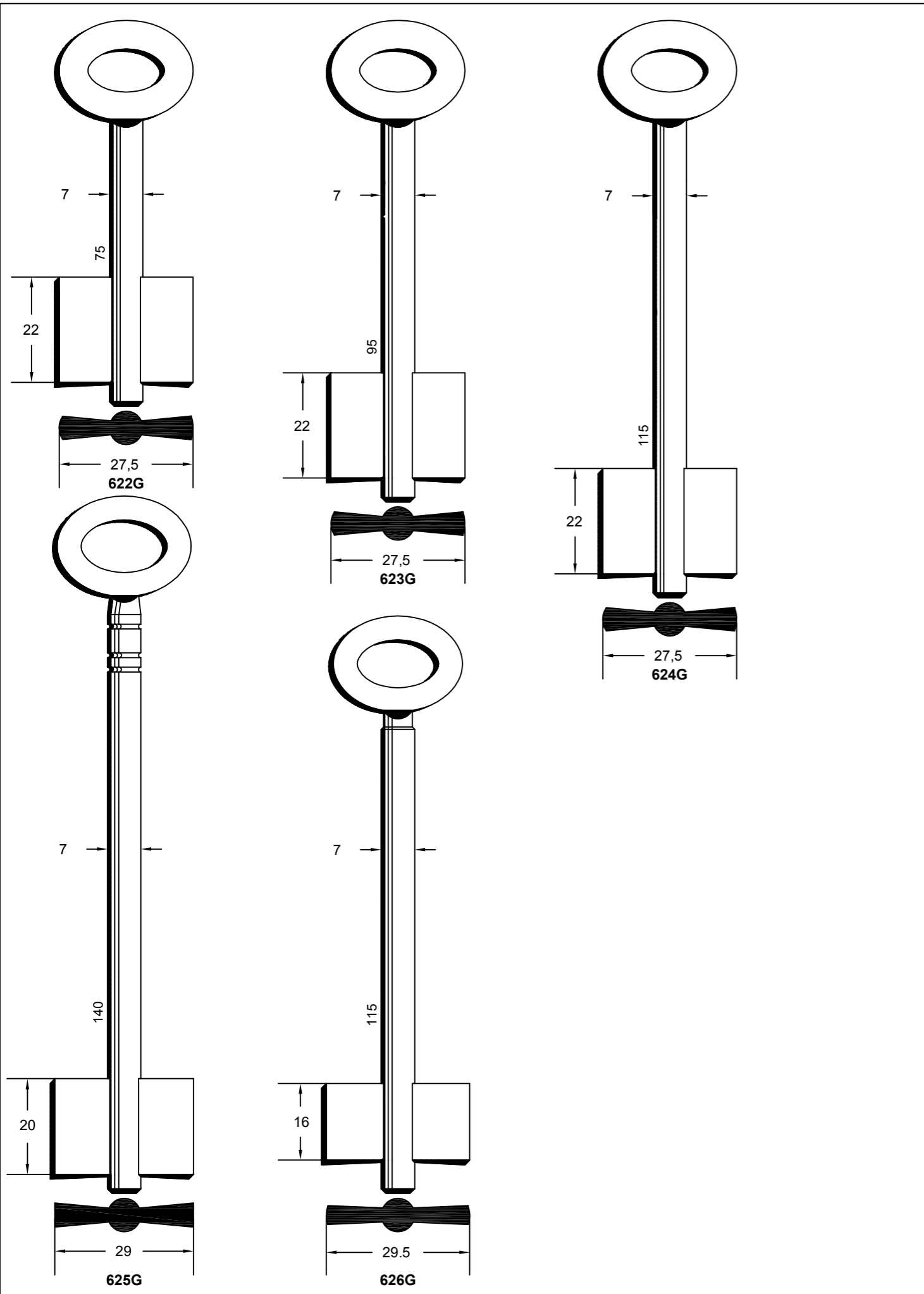

Concerning the marks and commercial denominations see legal warning.
 Concerniente a las marcas y denominaciones comerciales ver aviso legal.
 Marka eta izendapen komertzialiei dagokienez, ikus lege-oharra.
 Concernant les marques et denominations commerciales voir la note dans l'index.



Beziehen auf die marke und handelsname sehen sie die notiz im index.
 Relativamente às marcas e denominações comerciais, ver aviso legal.
 Jeśli chodzi o znaki i nazwy handlowe, patrz Informacje prawne.

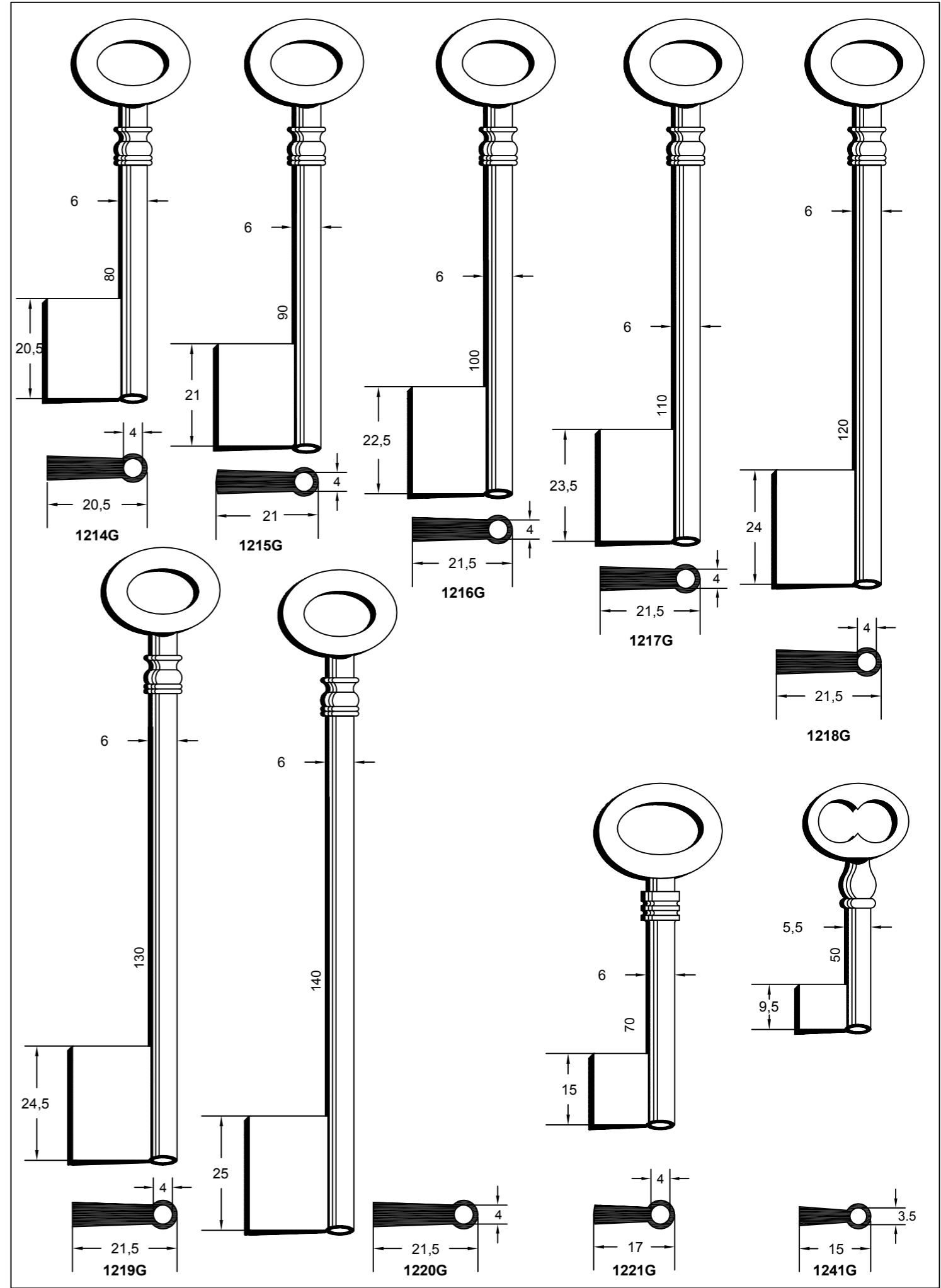
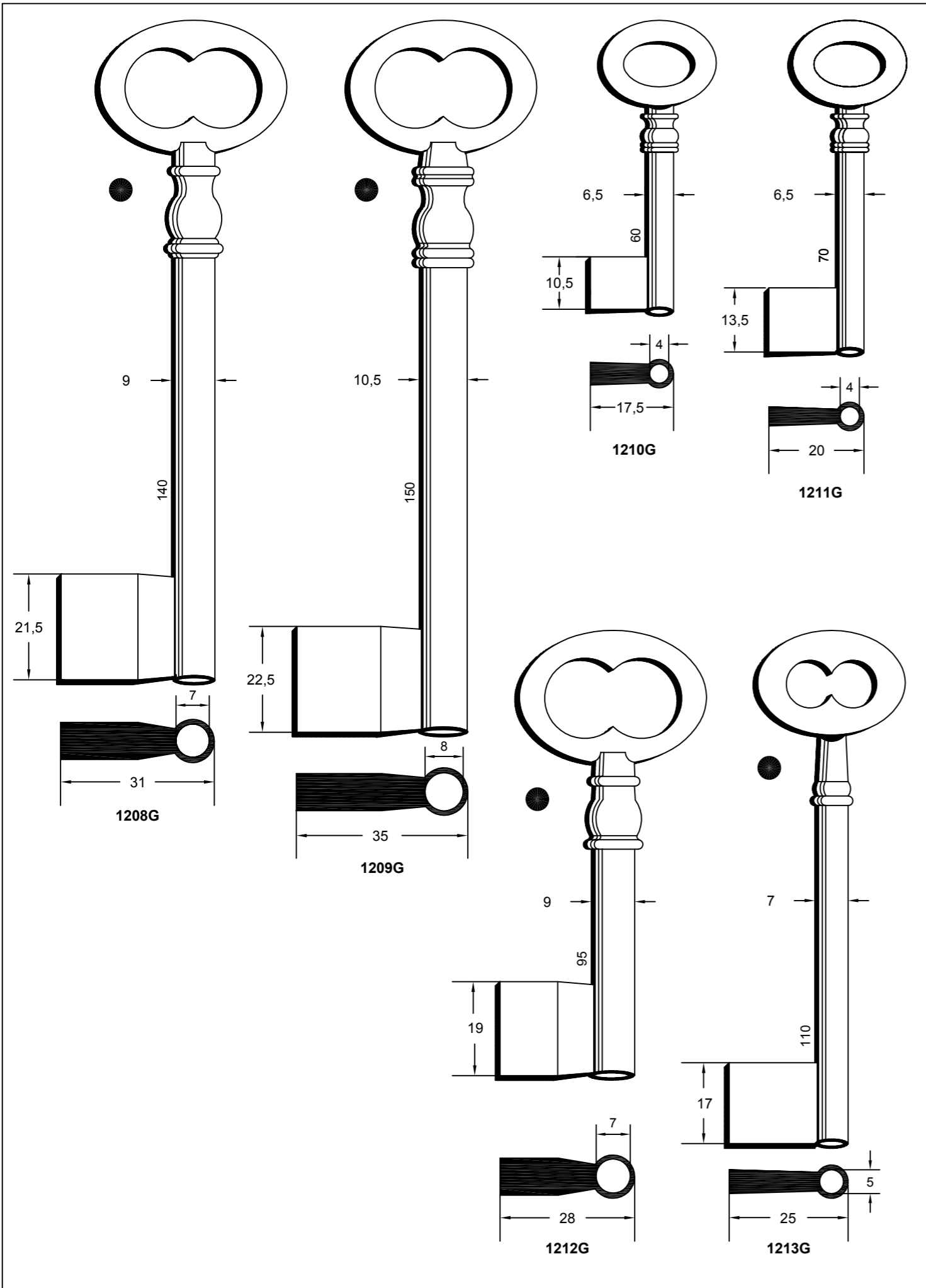

Concerning the marks and commercial denominations see legal warning.
 Concerniente a las marcas y denominaciones comerciales ver aviso legal.
 Marka eta izendapen komertzialiei dagokienez, ikus lege-oharra.
 Concernant les marques et dénominations commerciales voir la note dans l'index.

JMA Opening the future

JMA Opening the future

Beziehen auf die marke und handelsname sehen sie die notiz im index.
 Relativamente às marcas e denominações comerciais, ver aviso legal.
 Jeśli chodzi o znaki i nazwy handlowe, patrz Informacje prawne.

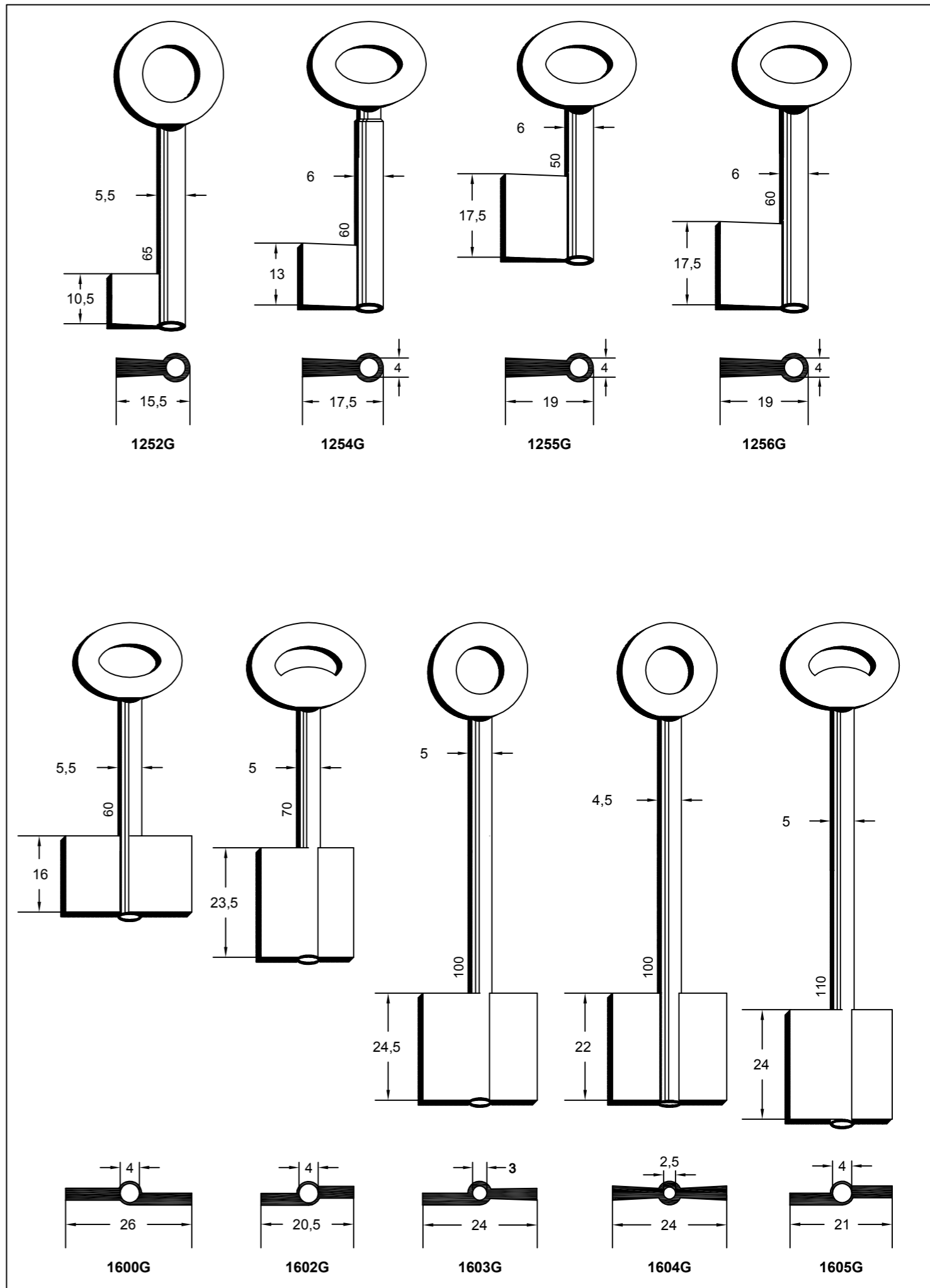
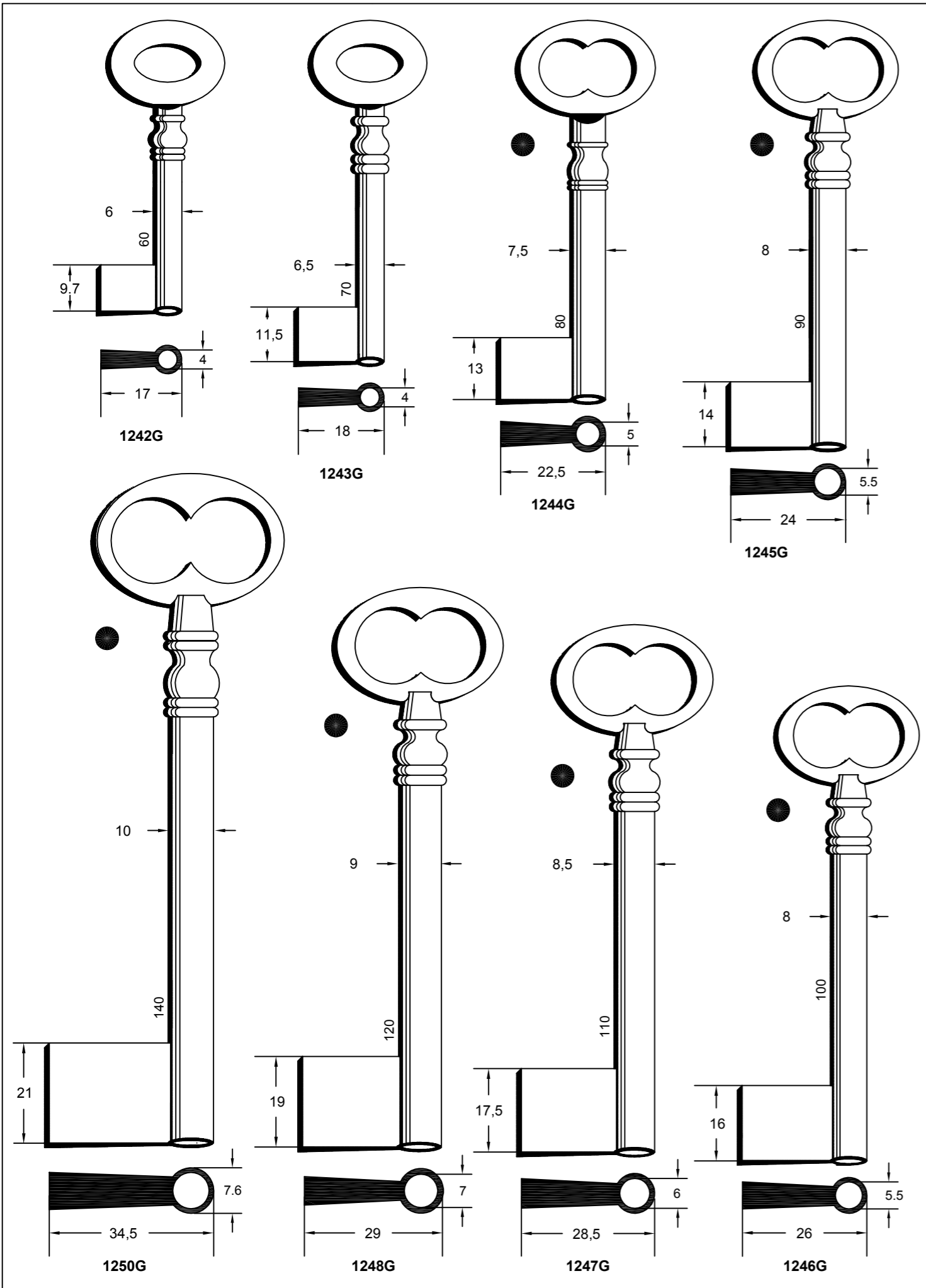

Concerning the marks and commercial denominations see legal warning.
 Concerniente a las marcas y denominaciones comerciales ver aviso legal.
 Marka eta izendapen komertzialiei dagokienez, ikus lege-oharra.
 Concernant les marques et dénominations commerciales voir la note dans l'index.

JMA Opening the future

JMA Opening the future

Beziehen auf die marke und handelsname sehen sie die notiz im index.
 Relativamente às marcas e denominações comerciais, ver aviso legal.
 Jeśli chodzi o znaki i nazwy handlowe, patrz Informacje prawne.

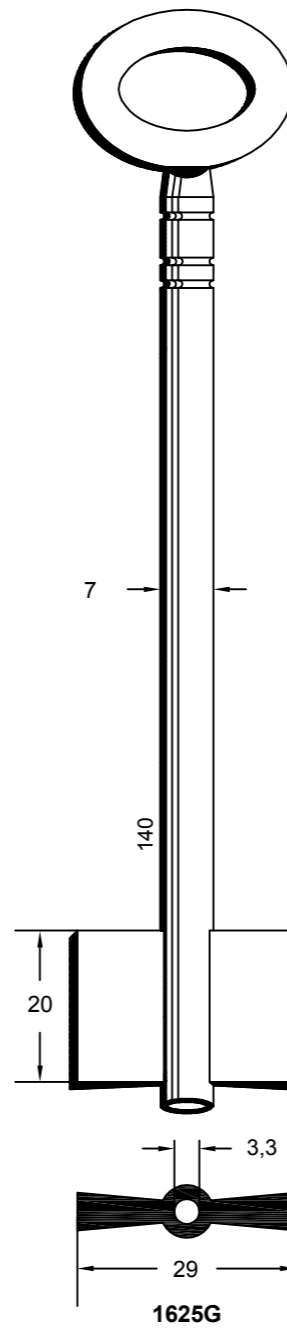
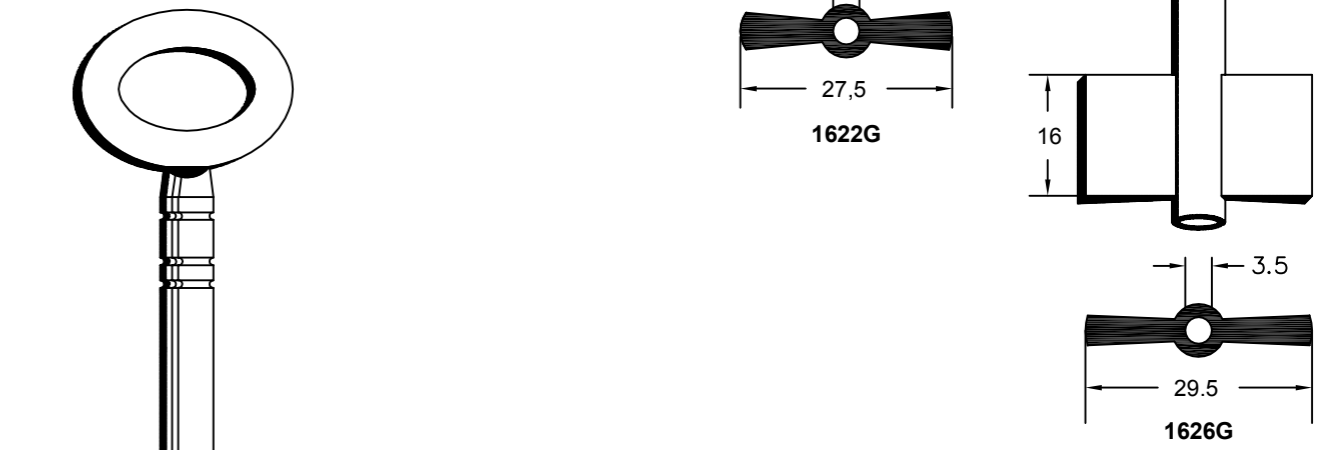
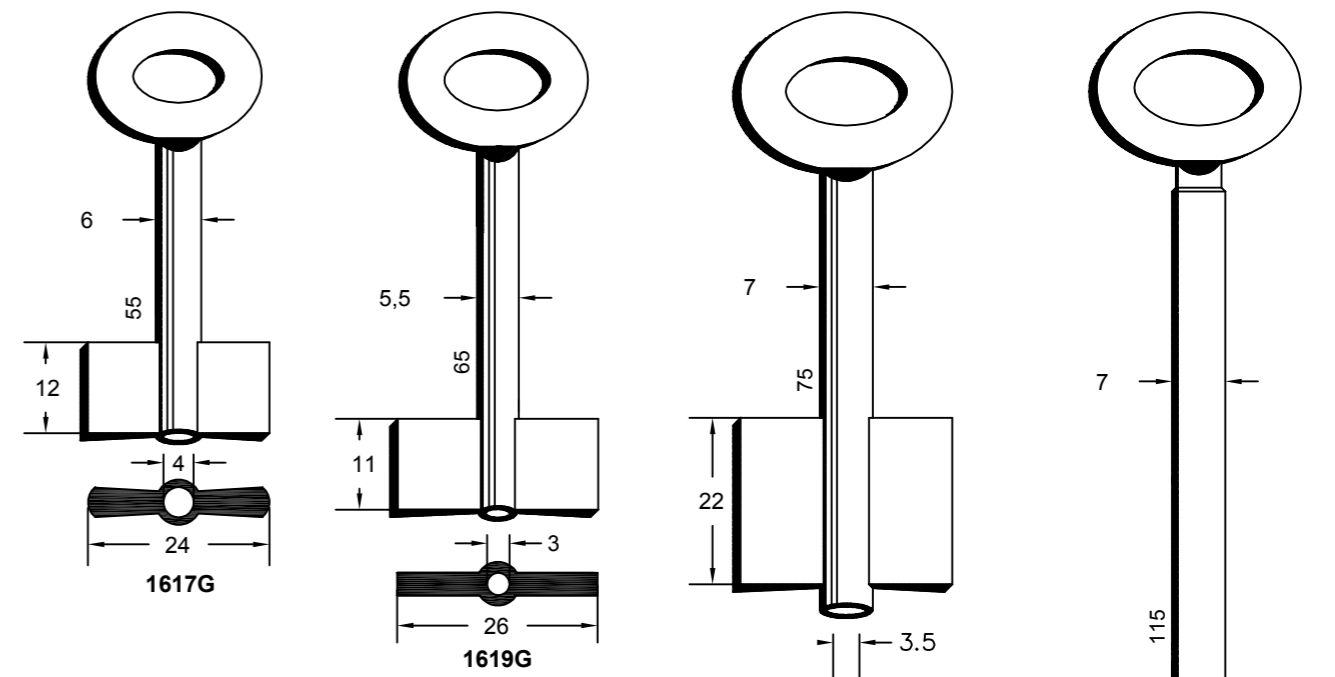
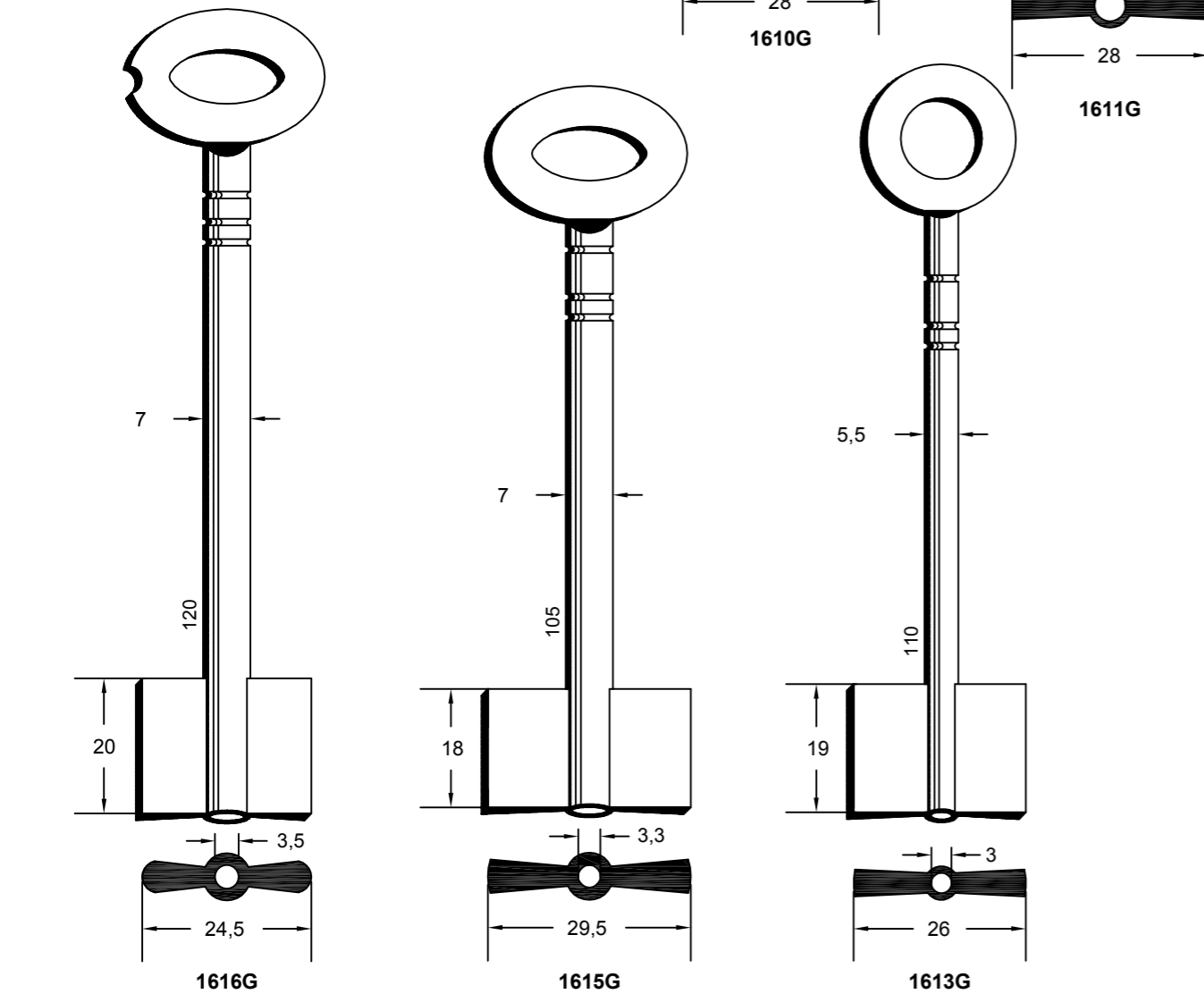
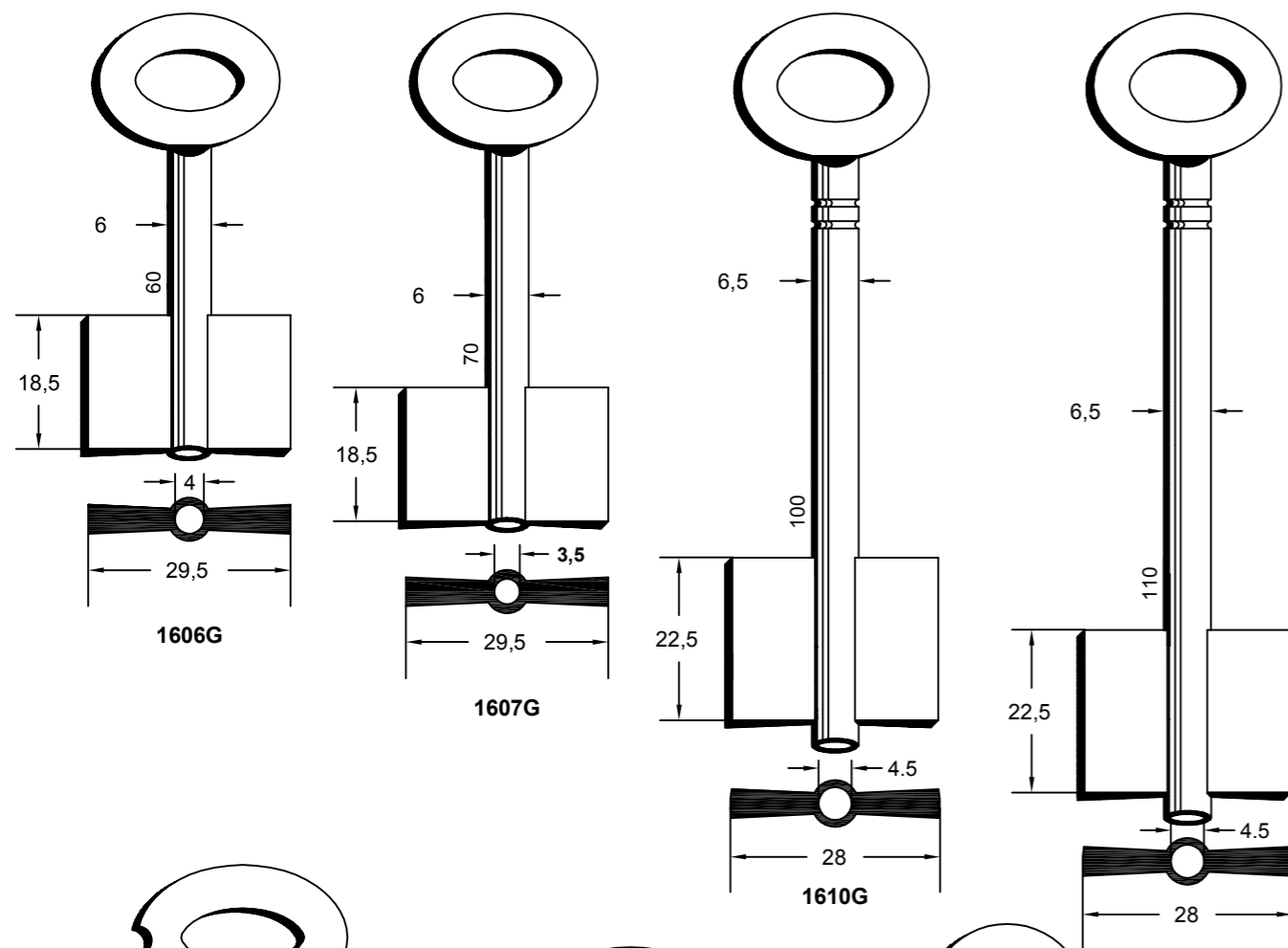

Concerning the marks and commercial denominations see legal warning.
 Concerniente a las marcas y denominaciones comerciales ver aviso legal.
 Marka eta izendapen komertzialiei dagokienez, ikus lege-oharra.
 Concernant les marques et dénominations commerciales voir la note dans l'index.

JMA Opening the future

JMA Opening the future

Beziehen auf die marke und handelsname sehen sie die notiz im index.
 Relativamente às marcas e denominações comerciais, ver aviso legal.
 Jeśli chodzi o znaki i nazwy handlowe, patrz Informacje prawne.



BRASS

Latón
Latoia

Laiton
Messing

Latão
Mosiqdz

MORTICE KEYS

Llaves de Gorja
Gorja motako giltzak

Clés à gorge
Tresor-Schlüssel

Chaves de gorja
Klucze zasuwowe

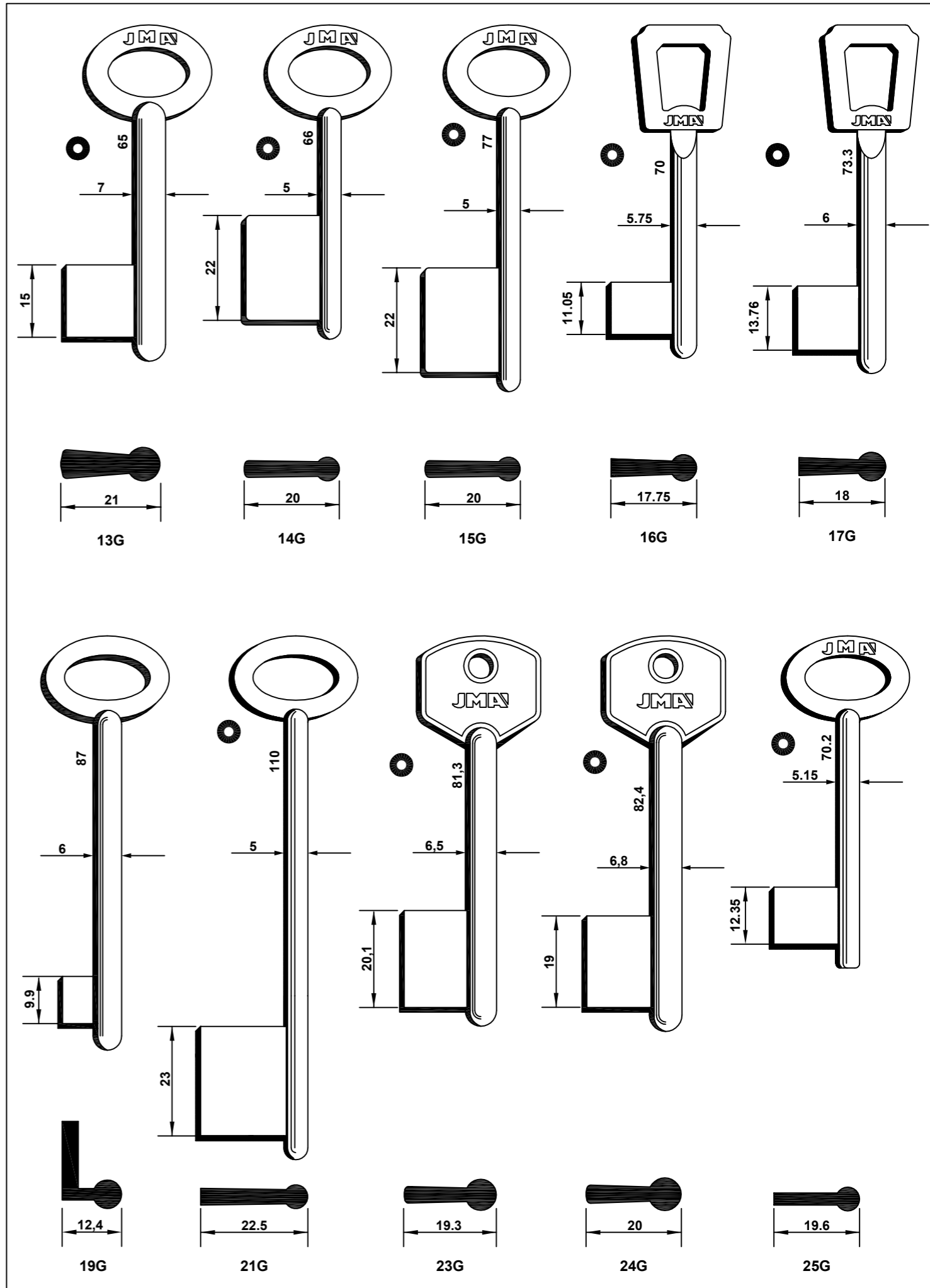
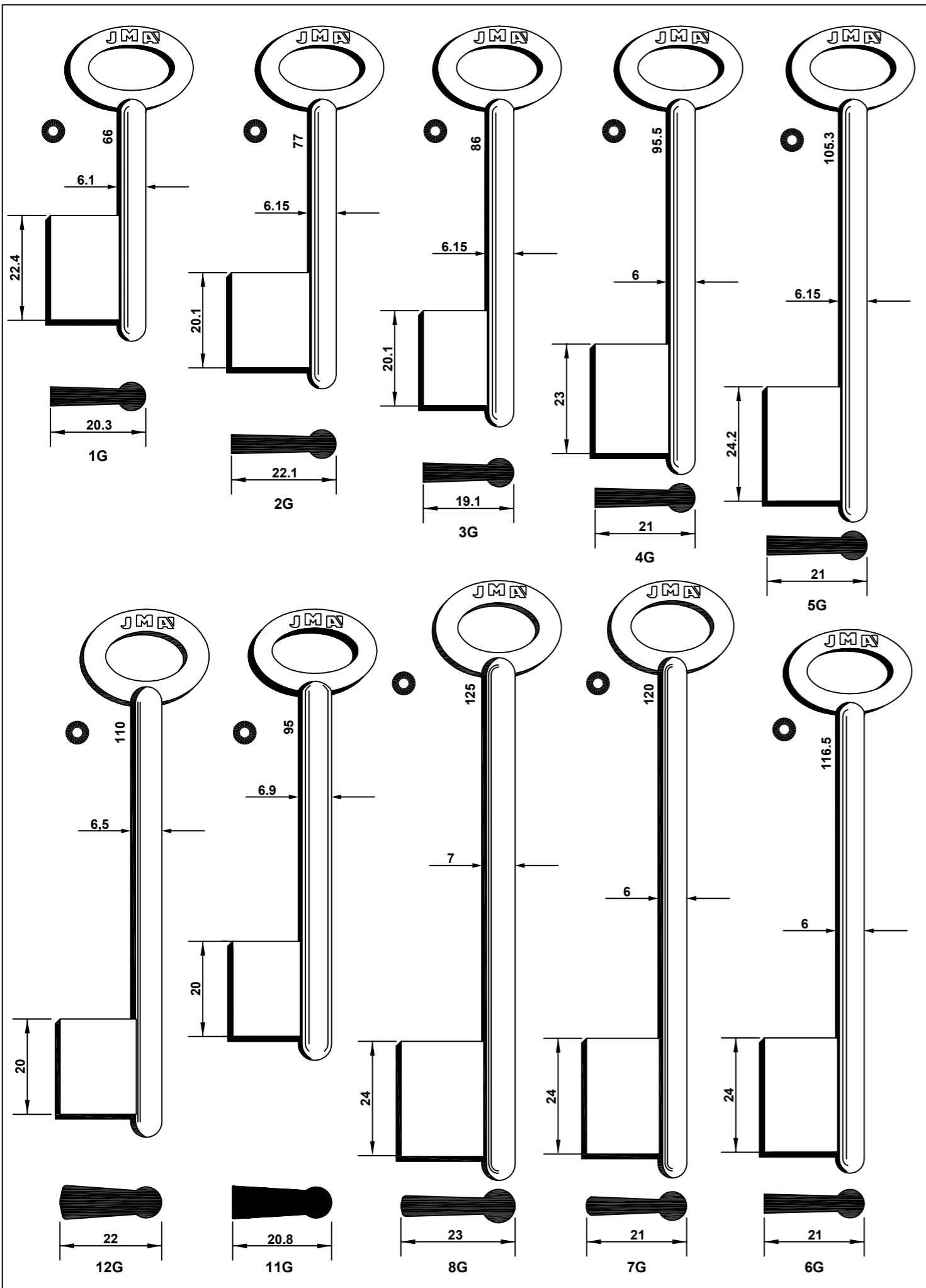

Concerning the marks and commercial denominations see legal warning.
 Concerniente a las marcas y denominaciones comerciales ver aviso legal.
 Marka eta izendapen komertzialiei dagokienez, ikus lege-oharra.
 Concernant les marques et dénominations commerciales voir la note dans l'index.

JMA Opening the future

JMA Opening the future

Beziehen auf die marke und handelsname sehen sie die notiz im index.
 Relativamente às marcas e denominações comerciais, ver aviso legal.
 Jeśli chodzi o znaki i nazwy handlowe, patrz Informacje prawne.

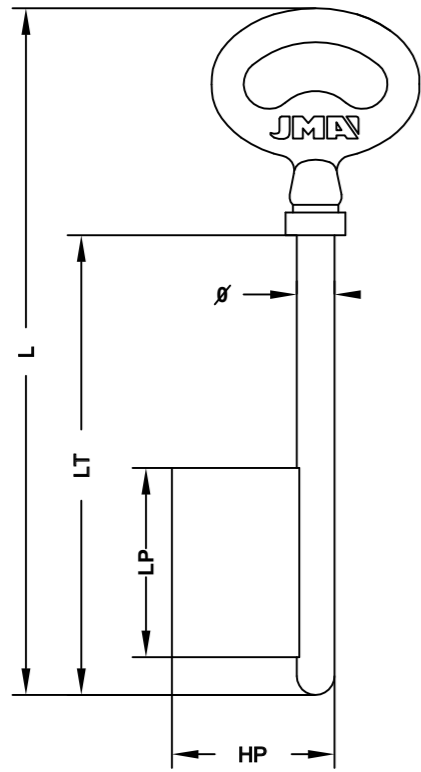

REF.	∅	L	LT	LP	HP
AD-3	5	90	60	25	21,5
AD-4	5	95	65	25	21,5
AD-5	5	100	70	25	21,5
AD-16	5	110	80	30	21,5
AD-6	5,5	80	59	25	22
AD-7	5,5	95	64	25	22
AD-18	5,5	95	64	30	22
AD-8	5,5	100	70	25	21,5
AD-19	5,5	110	80	30	22
AD-1	5,8	75	43	18	14
AD-9	5,8	80	50	25	19
AD-21	5,8	95	65	30	22
AD-10	6	90	59	25	22
AD-11	6	95	65	25	22
AD-12	6	100	70	25	22
AD-23	6	110	80	30	22
AD-24	6	120	88	35	22
AD-25	6	140	108	35	22
AD-26	6,5	95	65	30	23
AD-13	6,5	100	70	25	22
AD-29	6,5	100	70	30	23
AD-27	6,5	110	80	30	23
AD-28	6,5	120	90	35	23

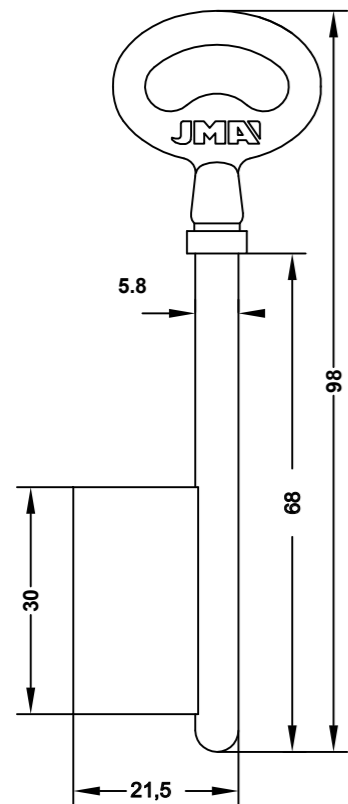

AD-2

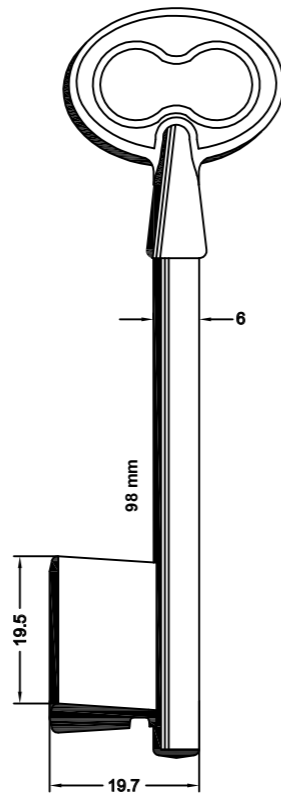

AD-44-....

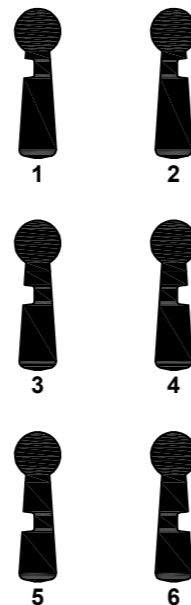

ADPLE-11

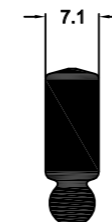
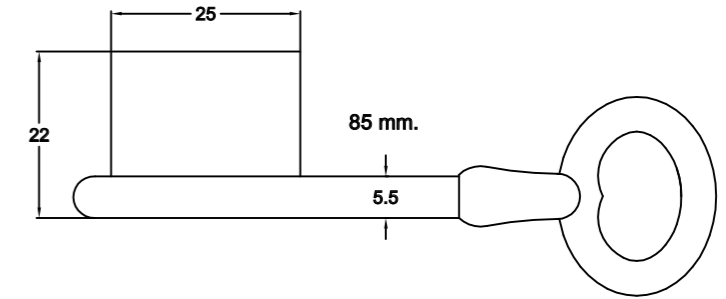

ADPLE-22

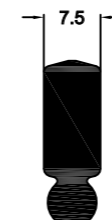
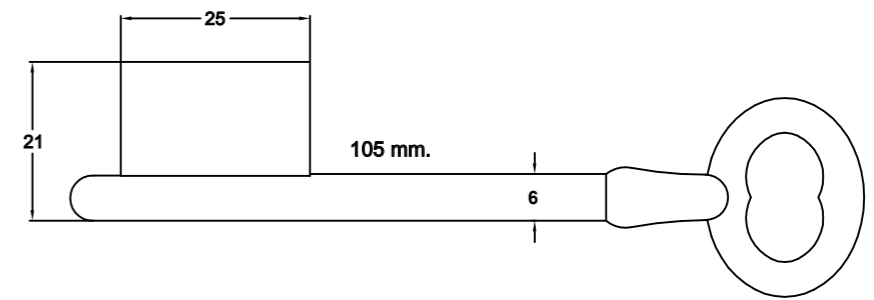

ADPLE-33

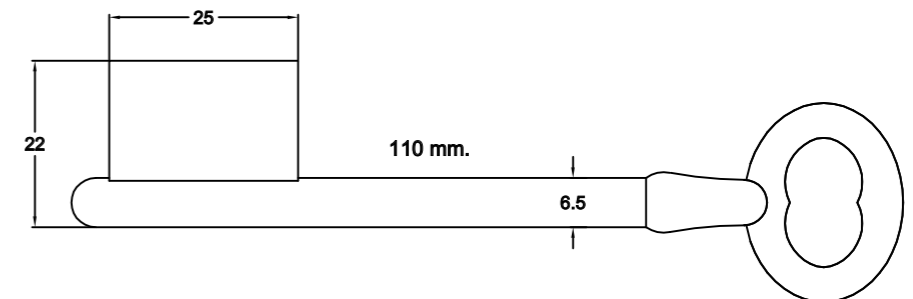

ADPLE-44

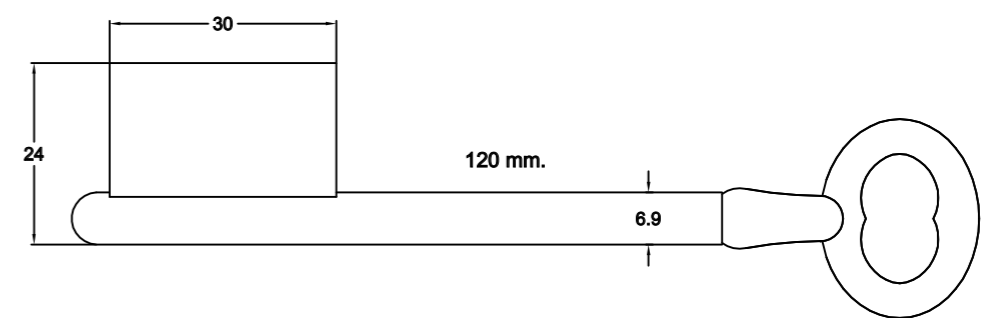

Concerning the marks and commercial denominations see legal warning.
 Concerniente a las marcas y denominaciones comerciales ver aviso legal.
 Marka eta izendapen komertzialiei dagokienez, ikus lege-oharra.
 Concernant les marques et dénominations commerciales voir la note dans l'index.

JMA Opening the future

JMA Opening the future

Beziehen auf die marke und handelsname sehen sie die notiz im index.
 Relativamente às marcas e denominações comerciais, ver aviso legal.
 Jeśli chodzi o znaki i nazwy handlowe, patrz Informacje prawne.

FOR: 101®		FOR: 126®		
101-1G	101-2G	126H-60G	126N-60G	126PP-60G

FOR: ASSA®		FOR: BODA®		FOR: BRICARD®
AS-6G/1	AS-6G/2	BOD-4G	BOD-5G	BRI-1

FOR: 716®	FOR: AGA®	FOR: ASSA®		
716-2G 716-1G	AGA-1G	AS-1G	AS-2G	AS-3G

FOR: BRICARD®		FOR: CHUBB®
BRI-2 BRI-3		CHU-1G
BRI-6L...		CHU-1G

Concerning the marks and commercial denominations see legal warning.
 Concerniente a las marcas y denominaciones comerciales ver aviso legal.
 Marka eta izendapen komertzialiei dagokienez, ikus lege-oharra.
 Concernant les marques et denominations commerciales voir la note dans l'index.



Beziehen auf die marke und handelsname sehen sie die notiz im index.
 Relativamente às marcas e denominações comerciais, ver aviso legal.
 Jeśli chodzi o znaki i nazwy handlowe, patrz Informacje prawne.

FOR: CHUBB®

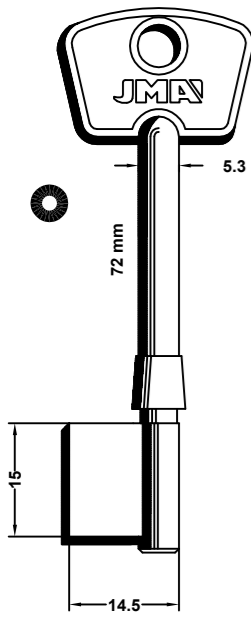

CHU-2G

FOR: DAR-MAR®

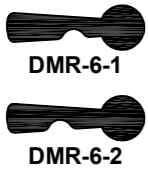
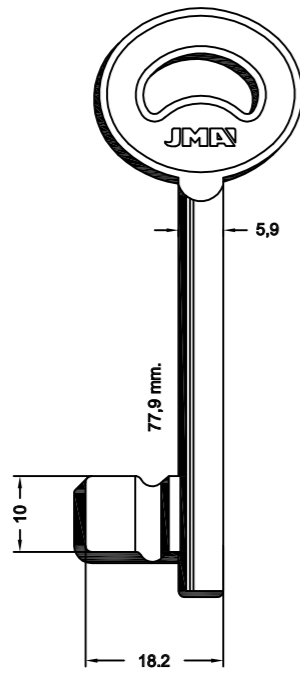

DMR-6-1
DMR-6-2

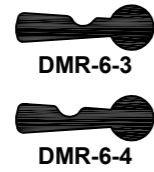
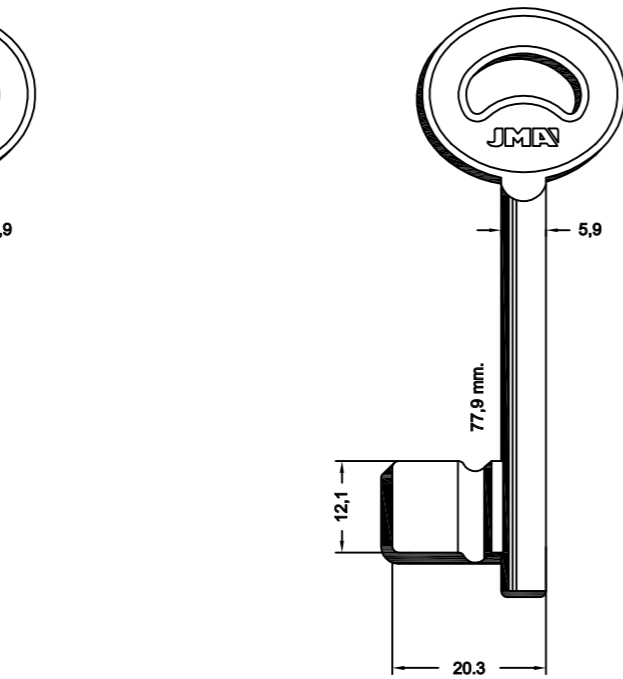

DMR-6-3
DMR-6-4

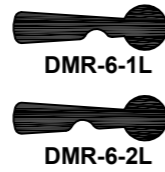

DMR-6-1L
DMR-6-2L

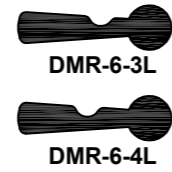

DMR-6-3L
DMR-6-4L

FOR: DAR-MAR®

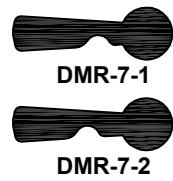
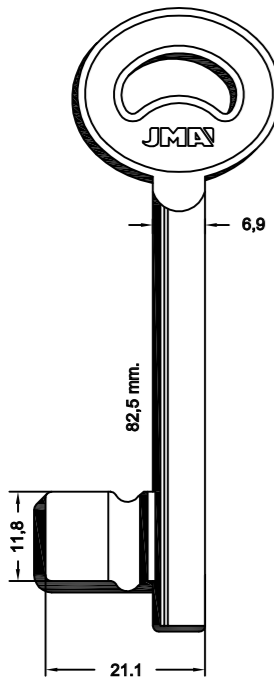

DMR-7-1
DMR-7-2

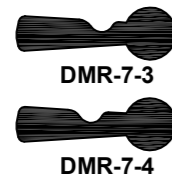

DMR-7-3
DMR-7-4

FOR: DEBEAURAIN-ND®

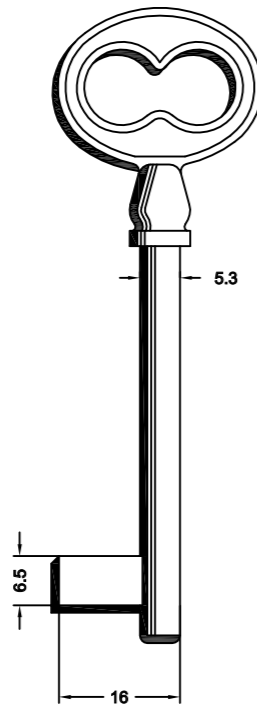

DEB-12L

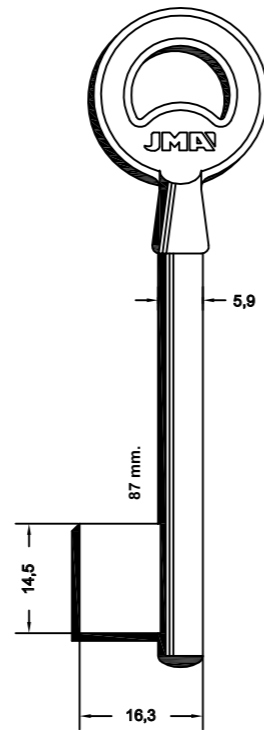

DEB-1

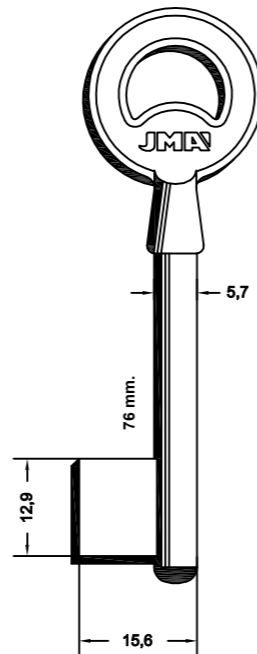

DEB-3

FOR: ELZETT®

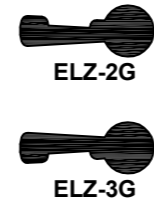
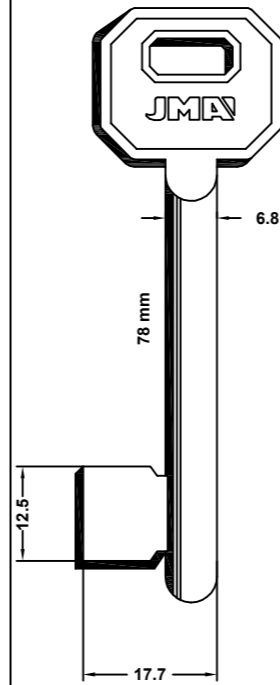

ELZ-2G
ELZ-3G

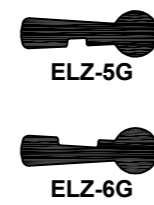
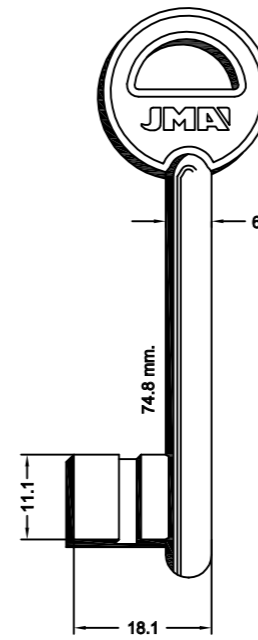

ELZ-5G
ELZ-6G

FOR: ESA®

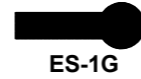
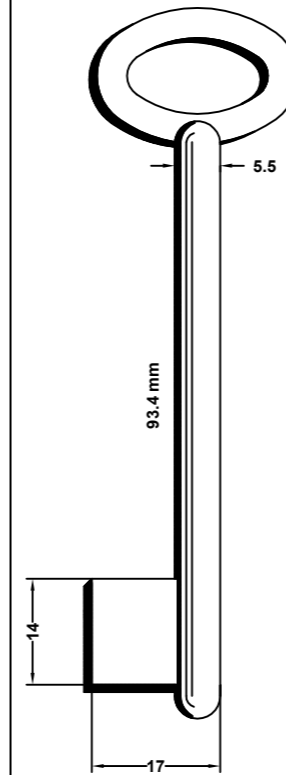

ES-1G

FOR: EUROSPEC®

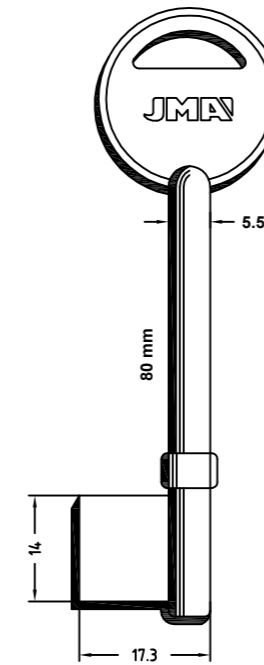

EUS-1G

FOR: ERA®

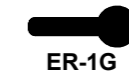
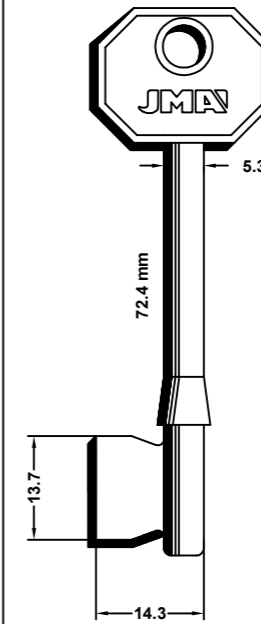

ER-1G

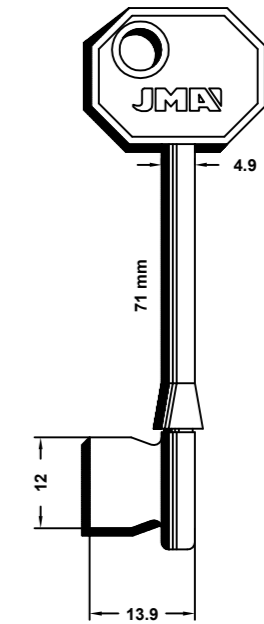

ER-4G

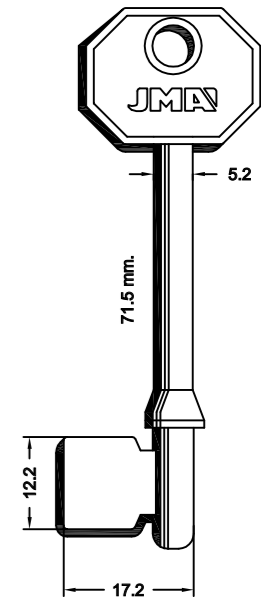

ER-5G

FOR: FAS-YALE®

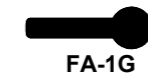
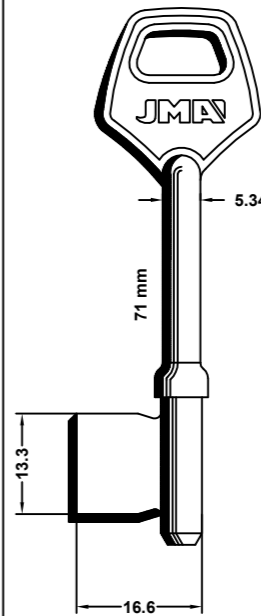

FA-1G

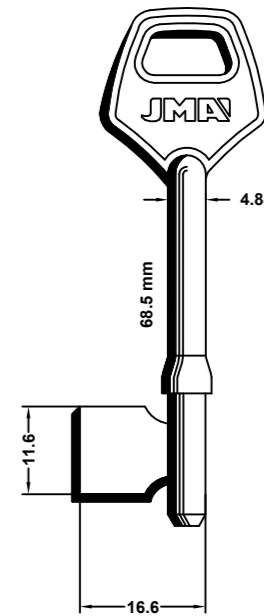

FA-2G

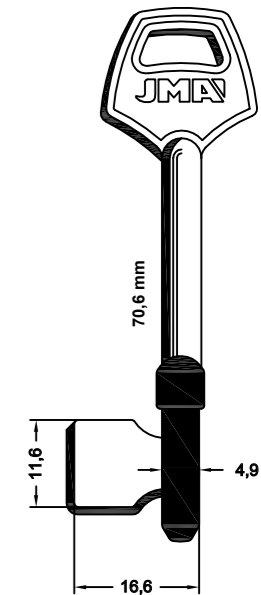

FA-2PPG

Concerning the marks and commercial denominations see legal warning.
 Concerniente a las marcas y denominaciones comerciales ver aviso legal.
 Marka eta izendapen komertzialiei dagokienez, ikus lege-oharra.
 Concernant les marques et dénominations commerciales voir la note dans l'index.

FOR: FAS-YALE®

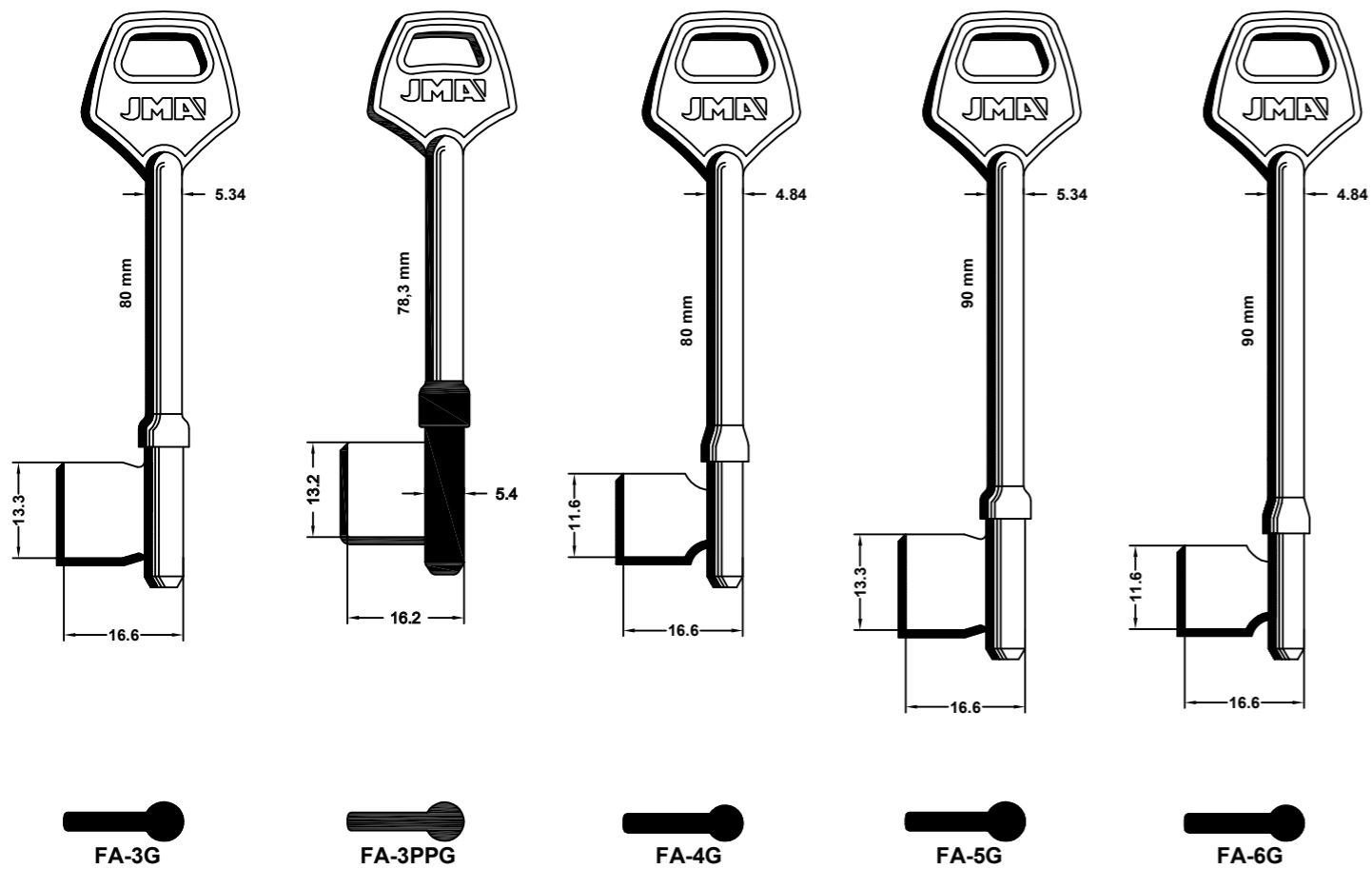

FOR: GUARDIAN®

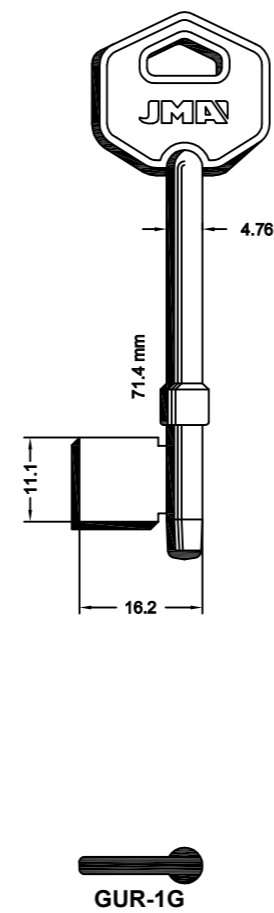

FOR: HENDERSON®

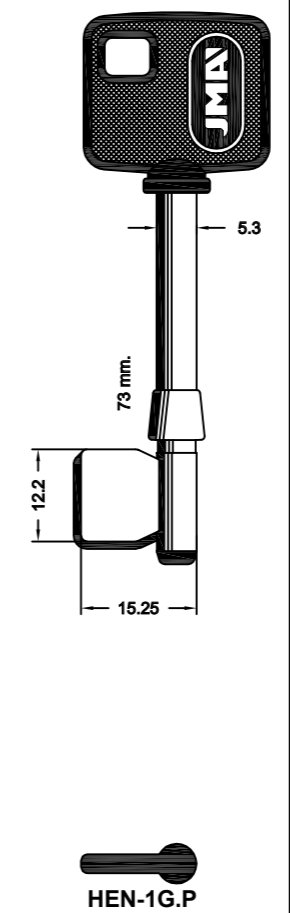

FOR: HOBES®

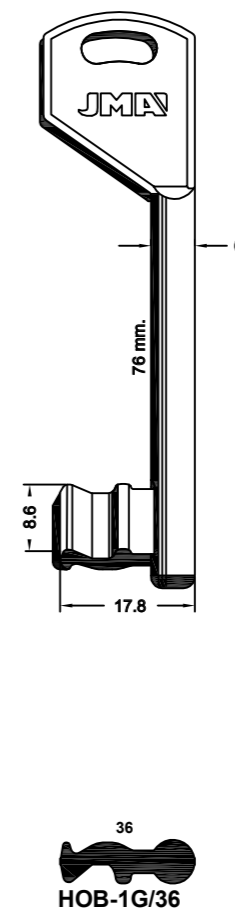

FOR: JPM®

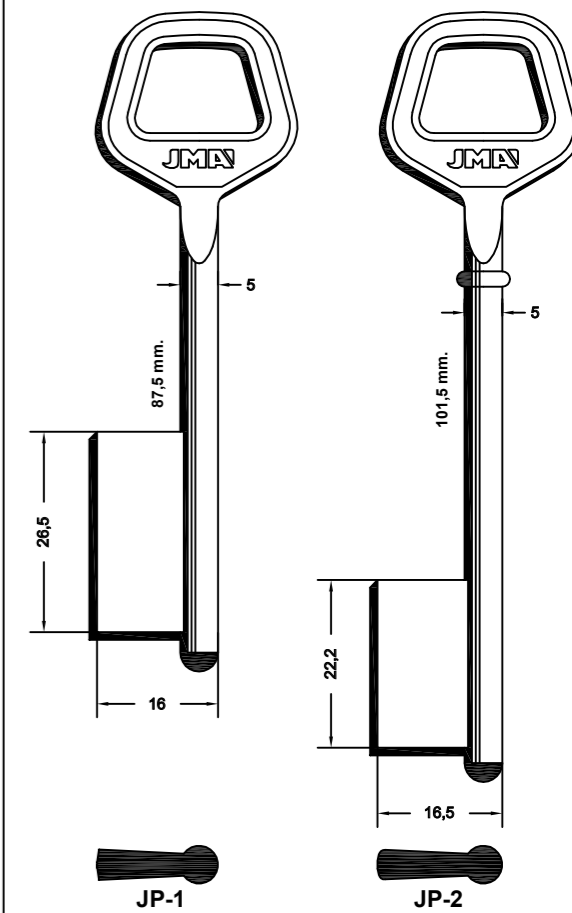

FOR: FAS-YALE®

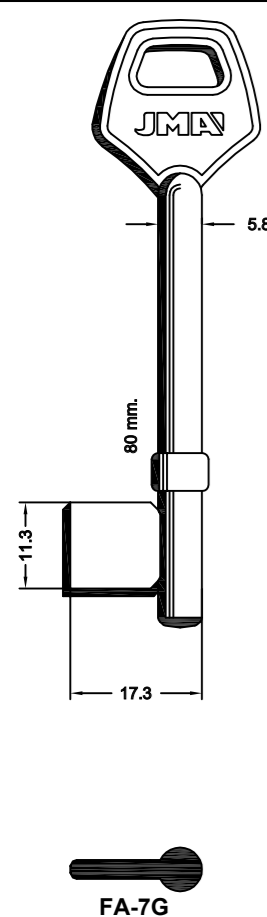

FOR: FAS®

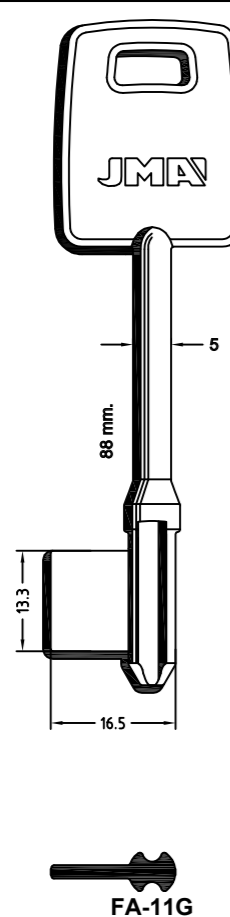

FOR: FICHET®

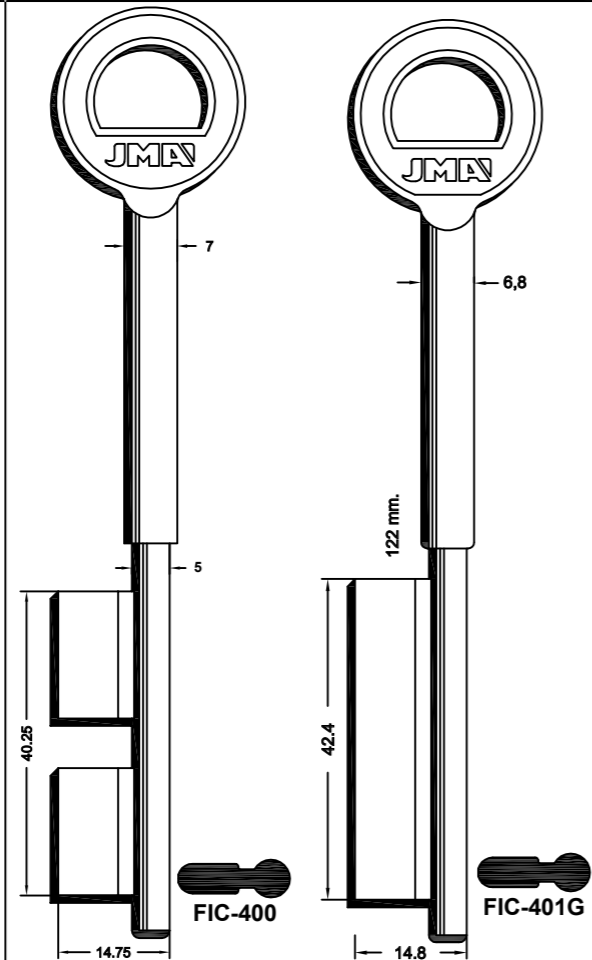

FOR: GPZ®

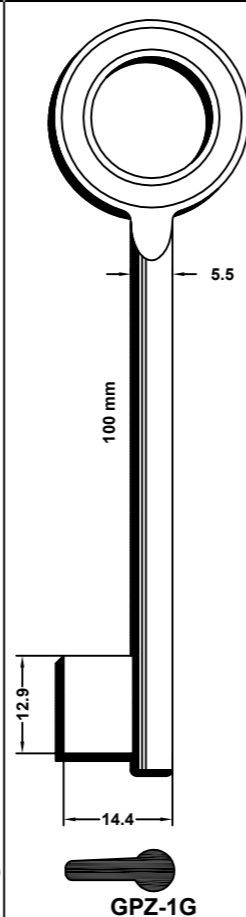

FOR: JPM®

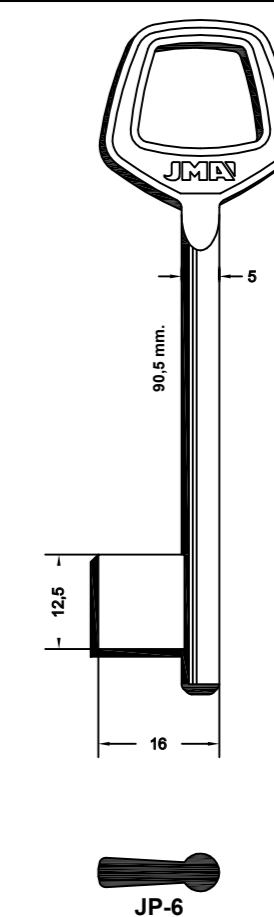
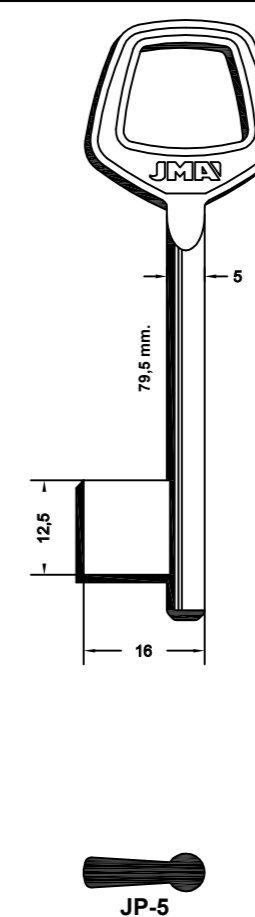
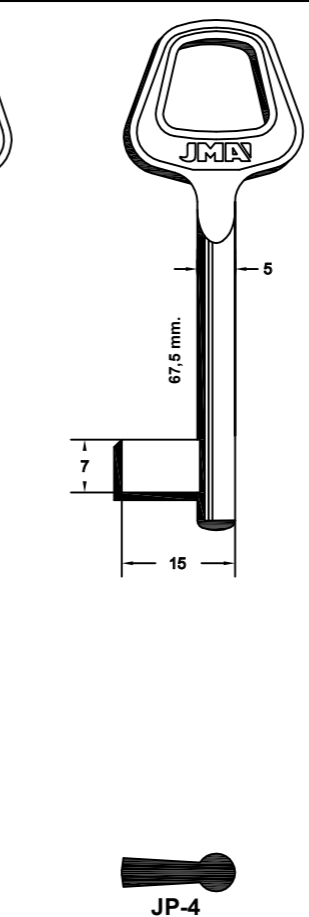
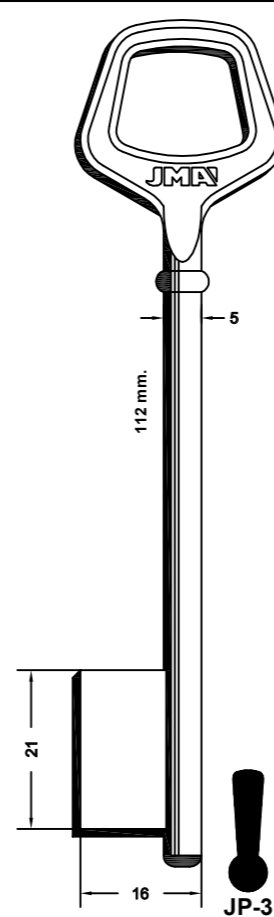

FOR: LAPERCHE®

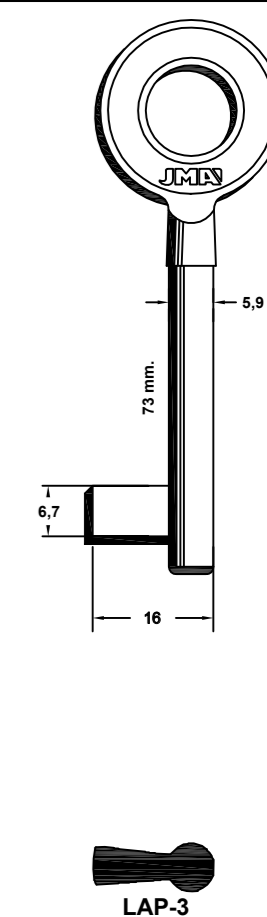

Concerning the marks and commercial denominations see legal warning.
 Concerniente a las marcas y denominaciones comerciales ver aviso legal.
 Marka eta izendapen komertzialiei dagokienez, ikus lege-oharra.
 Concernant les marques et dénominations commerciales voir la note dans l'index.

JMA Opening the future

JMA Opening the future

Beziehen auf die Marke und Handelsname sehen Sie die Notiz im Index.
 Relativamente às marcas e denominações comerciais, ver aviso legal.
 Jeśli chodzi o znaki i nazwy handlowe, patrz Informacje prawne.

FOR: LAPERCHE®	FOR: LAR®	FOR: LÅSBOLAGET®		

FOR: MOSKVA®	FOR: MP®	FOR: ORENGO®		FOR: OSTMARK®

FOR: LÅSBOLAGET®	FOR: MAFOR®	FOR: MCM®	FOR: MOBELLA®

FOR: OSTMARK®	FOR: PASSEPARTOUT®	FOR: RENAG®	FOR: REX®												
	<table border="1"> <thead> <tr> <th></th> <th>A</th> <th>B</th> </tr> </thead> <tbody> <tr> <td>PPT-3G</td> <td>14,5</td> <td>7,6</td> </tr> <tr> <td>PPT-2G</td> <td>16,5</td> <td>7,9</td> </tr> <tr> <td>PPT-1G</td> <td>18</td> <td>7,6</td> </tr> </tbody> </table> FOR: BONAITI® -MAVE® -OASA® -PATENT® FOR: PERINO® -STIQAM® FOR: AGB® -CORNI® -MP® -OSMET® -PATENT® FOR: SMET® FOR: BONAITI® -ISEO® -MP®		A	B	PPT-3G	14,5	7,6	PPT-2G	16,5	7,9	PPT-1G	18	7,6		
	A	B													
PPT-3G	14,5	7,6													
PPT-2G	16,5	7,9													
PPT-1G	18	7,6													

Concerning the marks and commercial denominations see legal warning.
 Concerniente a las marcas y denominaciones comerciales ver aviso legal.
 Marka eta izendapen komertzialiei dagokienez, ikus lege-oharra.
 Concernant les marques et denominations commerciales voir la note dans l'index.

FOR: REX®	FOR: SELECT®	FOR: TESA®		
<p>86 mm</p> <p>11.1</p> <p>16.2</p> <p>REX-2G</p>	<p>73.7 mm.</p> <p>14.5</p> <p>16</p> <p>5</p> <p>SEL-1</p>	<p>73.5 mm</p> <p>8.5</p> <p>18.25</p> <p>5.15</p> <p>TE-1G</p>	<p>62.6 mm.</p> <p>8</p> <p>16.1</p> <p>6</p> <p>TE-2G</p>	<p>71 mm</p> <p>8</p> <p>16.2</p> <p>6.15</p> <p>TE-3G</p>

FOR: TRIO-VING®				
<p>68 mm</p> <p>10.5</p> <p>12.5</p> <p>TV-5G</p>	<p>68.5 mm</p> <p>14</p> <p>20.3</p> <p>TV-14G</p>	<p>67 mm.</p> <p>13</p> <p>19</p> <p>TV-19G</p>	<p>TV-15G</p> <p>TV-16G</p>	<p>91 mm</p> <p>10.5</p> <p>12.5</p> <p>TV-21G</p>
	<p>TV-13G</p> <p>TV-14G</p>		<p>TV-17G</p> <p>TV-18G</p>	

FOR: TRIO-VING®					
<p>64 mm</p> <p>12.2</p> <p>18</p> <p>TV-1G</p>	<p>91 mm</p> <p>12.2</p> <p>18</p> <p>TV-2G</p>	<p>68 mm</p> <p>11.6</p> <p>17</p> <p>TV-3G</p>	<p>TV-7G</p> <p>TV-8G</p> <p>TV-9G</p>	<p>TV-10G</p> <p>TV-11G</p> <p>TV-12G</p>	

FOR: TRIO-VING®		FOR: UCEM®		FOR: UCEM®
<p>TV-22G</p> <p>TV-25G</p>	<p>TV-23G</p> <p>TV-26G</p>	<p>100 mm</p> <p>12</p> <p>21</p> <p>6.5</p> <p>UCEM-1G</p>	<p>100 mm</p> <p>15.5</p> <p>19.25</p> <p>6.5</p> <p>UCEM-2G</p>	<p>100 mm</p> <p>20.5</p> <p>17.75</p> <p>6.5</p> <p>UCEM-3G</p>

Concerning the marks and commercial denominations see legal warning.
 Concerniente a las marcas y denominaciones comerciales ver aviso legal.
 Marka eta izendapen komertzialiei dagokienez, ikus lege-oharra.
 Concernant les marques et denominations commerciales voir la note dans l'index.

JMA® Opening the future

JMA® Opening the future

Beziehen auf die Marke und Handelsname sehen Sie die Notiz im Index.
 Relativamente às marcas e denominações comerciais, ver aviso legal.
 Jeśli chodzi o znaki i nazwy handlowe, patrz Informacje prawne.

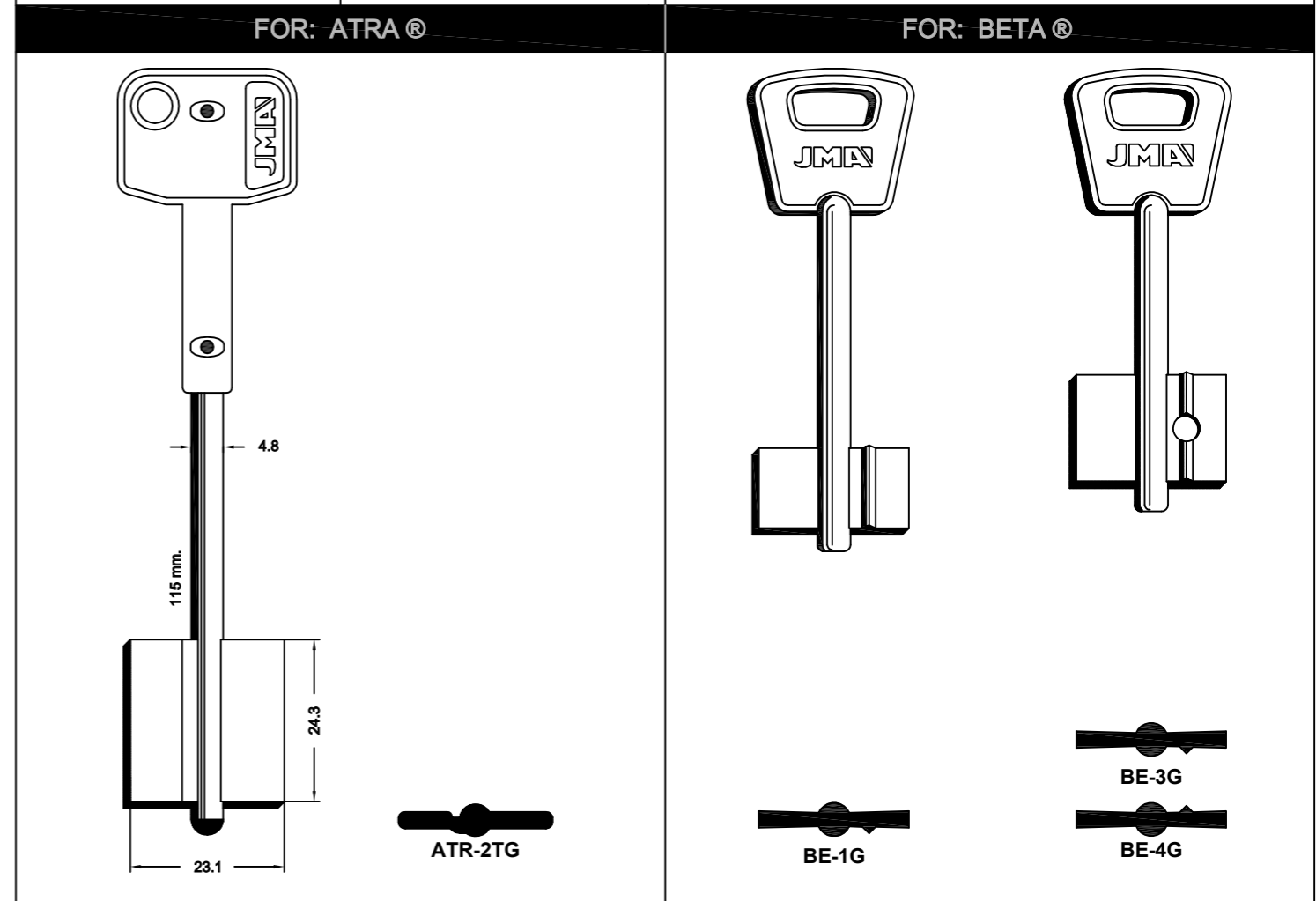
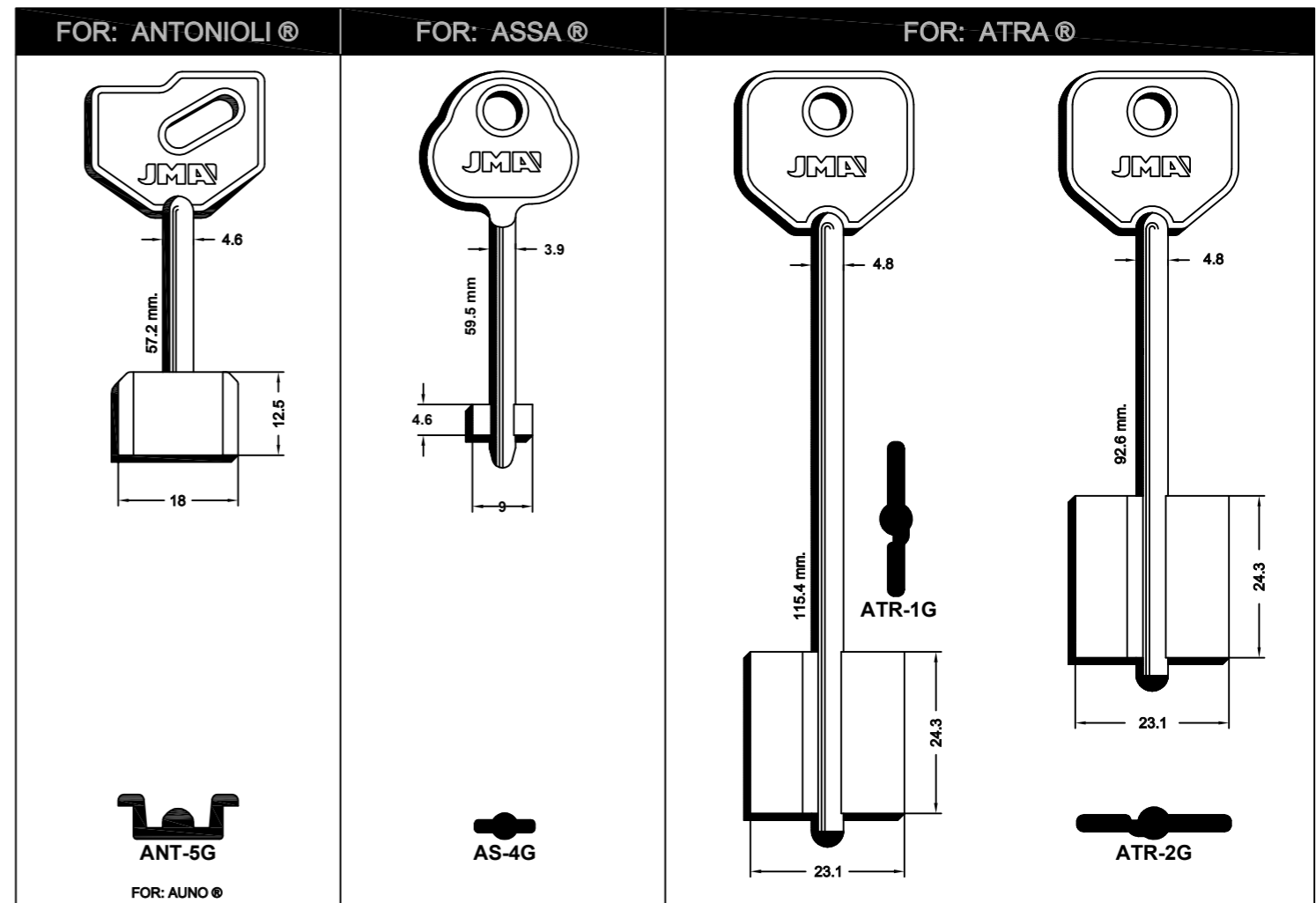
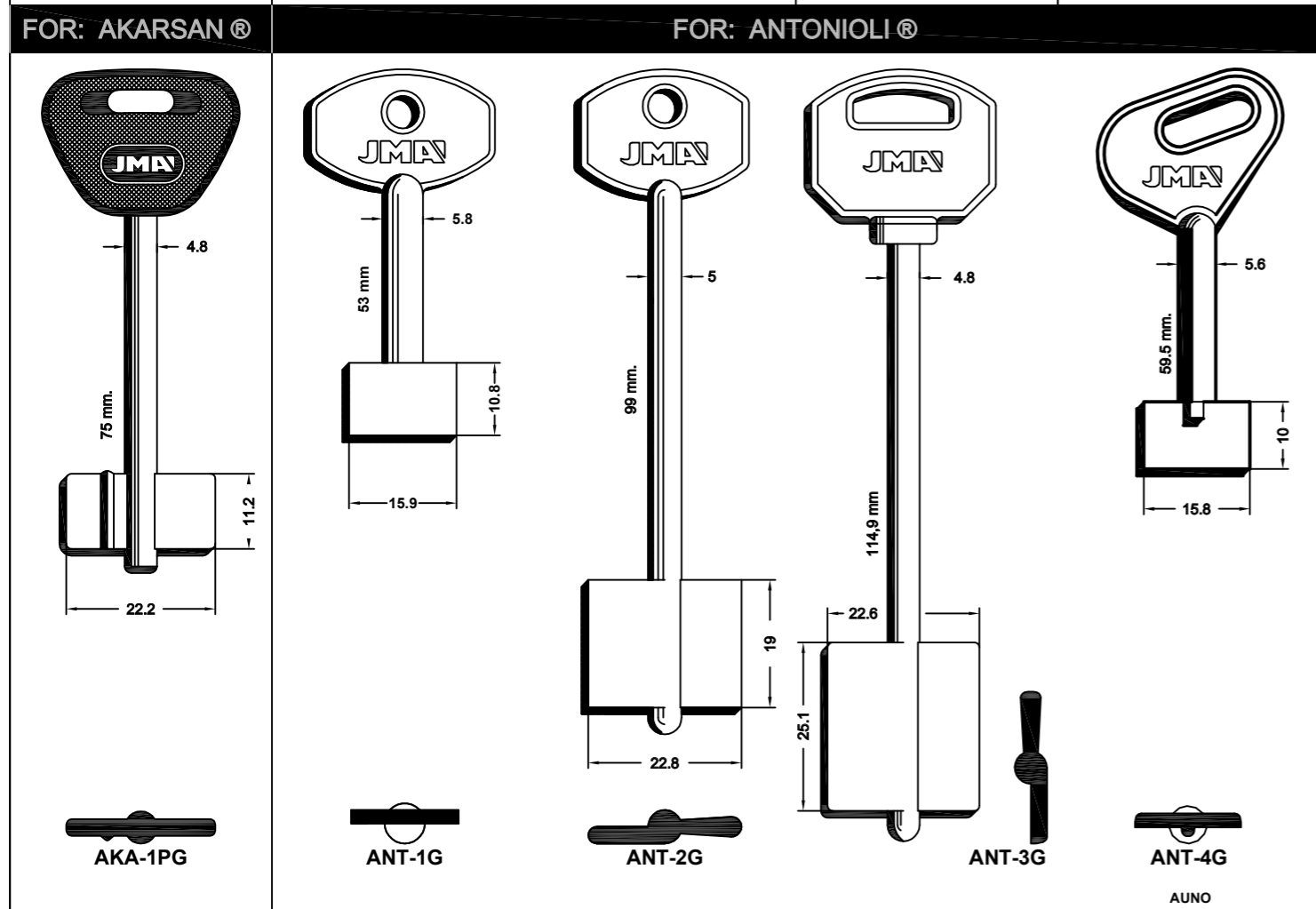
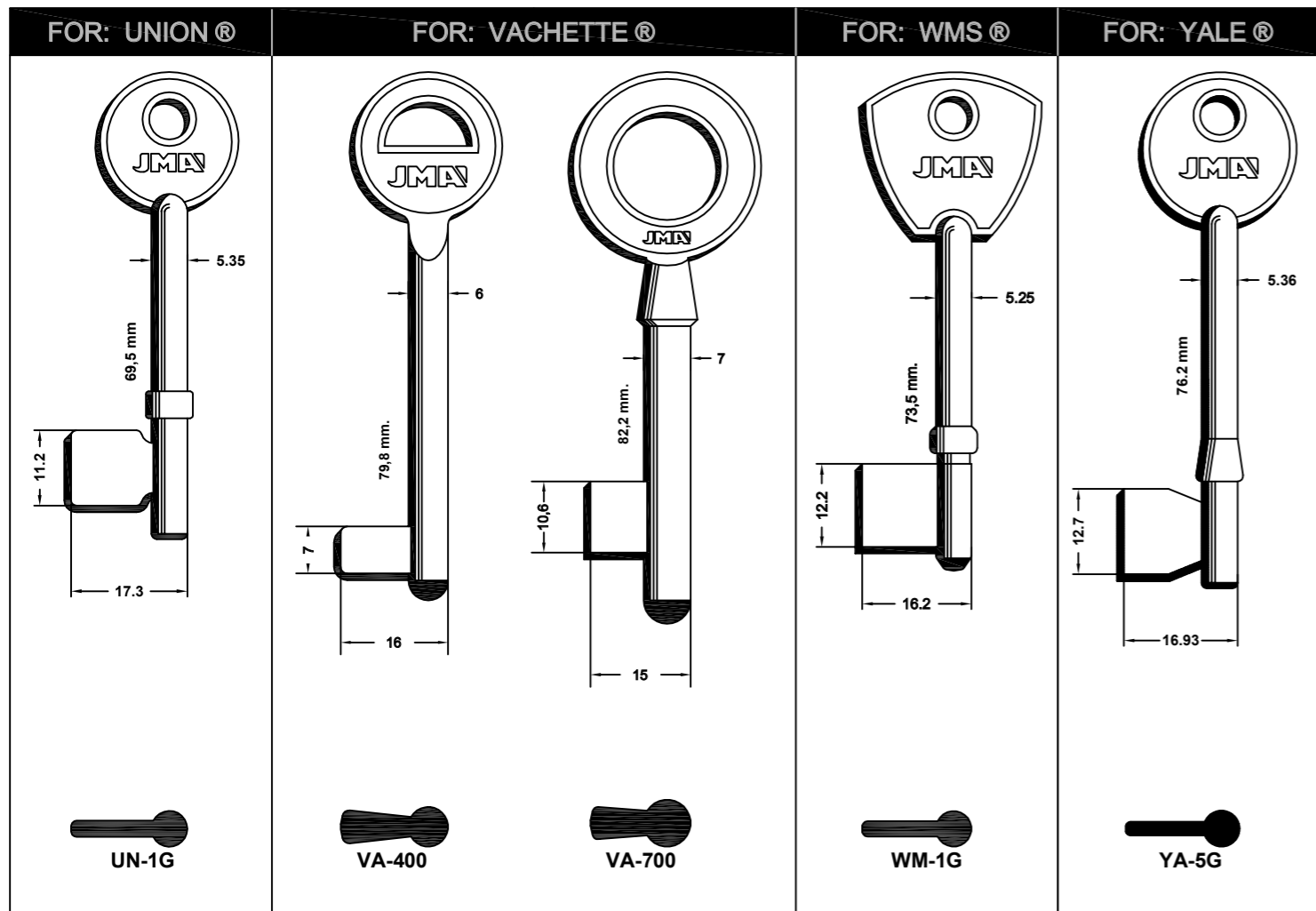

Concerning the marks and commercial denominations see legal warning.
 Concerniente a las marcas y denominaciones comerciales ver aviso legal.
 Marka eta izendapen komertzialiei dagokienez, ikus lege-oharra.
 Concernant les marques et dénominations commerciales voir la note dans l'index.

JMA® Opening the future

JMA® Opening the future

Beziehen auf die marke und handelsname sehen sie die notiz im index.
 Relativamente às marcas e denominações comerciais, ver aviso legal.
 Jeśli chodzi o znaki i nazwy handlowe, patrz Informacje prawne.

FOR: BETA®

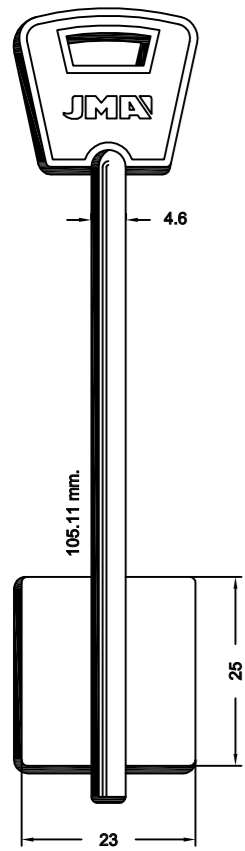

BE-5G



BE-6G

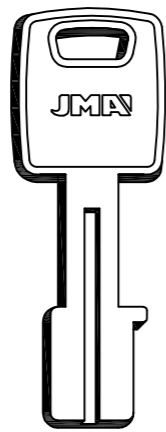

BE-7G

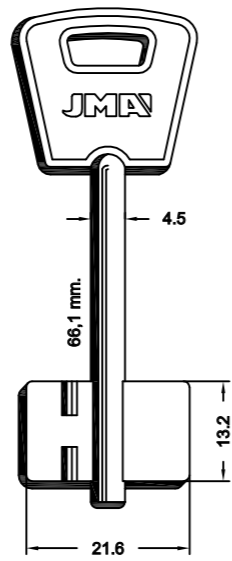

BE-10G

FOR: BMC®

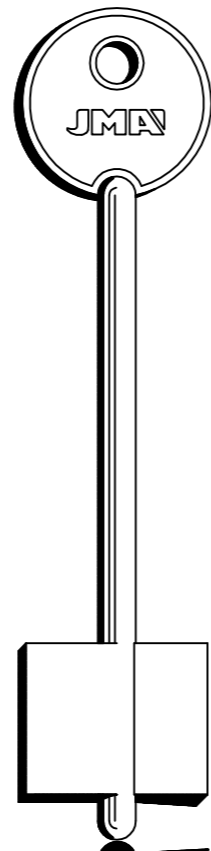

BMC-1G

FOR: BOXAFE®

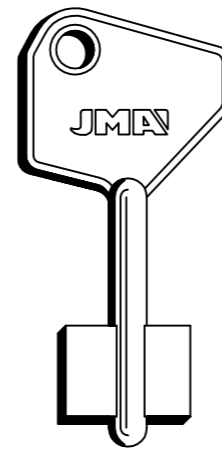

BOX-1G

FOR: CAF®

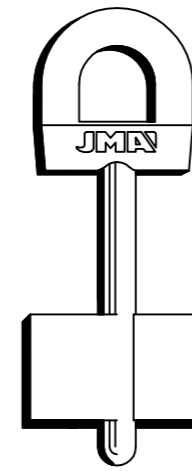

CAF-1G

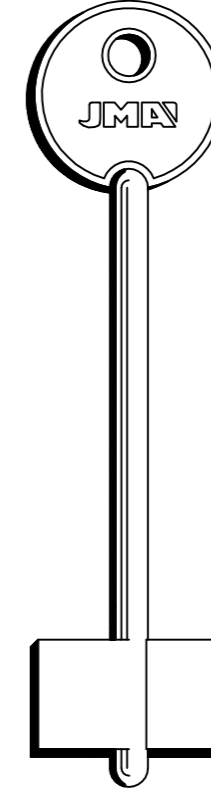

CAF-2G

FOR: CERUTTI®

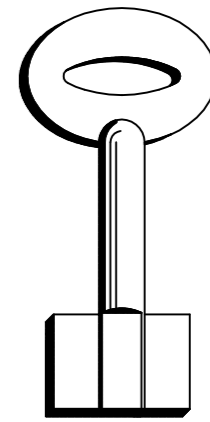

CRT-1G

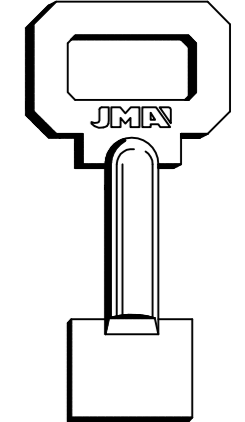

CRT-2G

FOR: BODA®

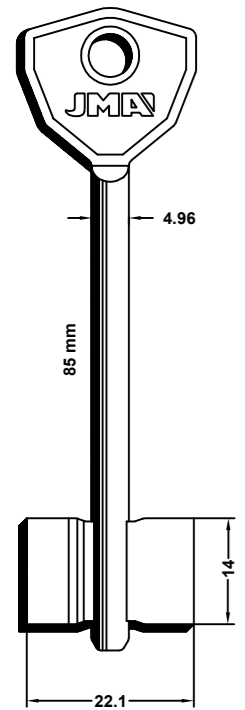

BOD-1G

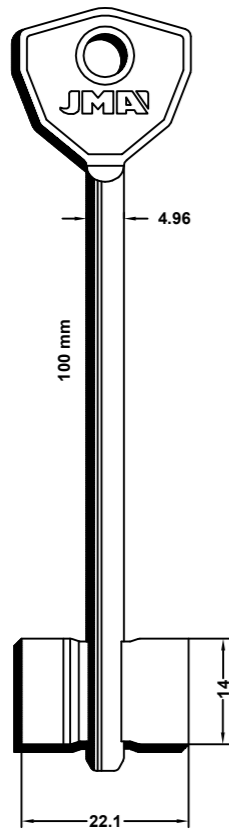

BOD-2G

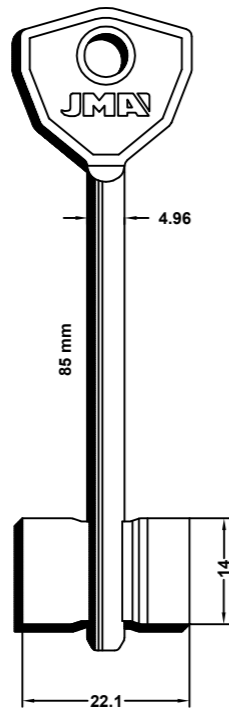

BOD-3G

FOR: BOGATIR®

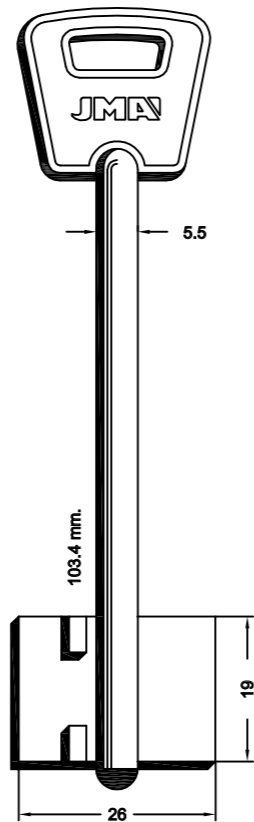

BOG-1G

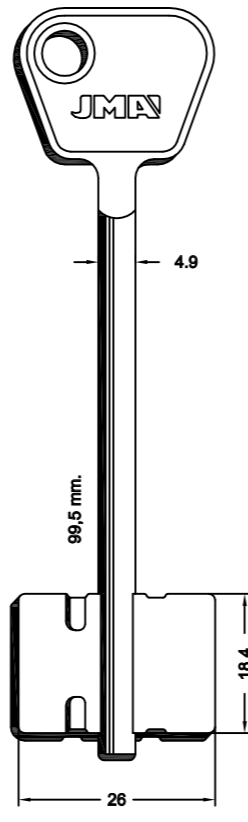

BOG-2G

FOR: CERUTTI®



CRT-3G

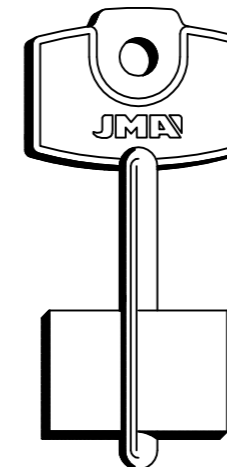

CRT-4G

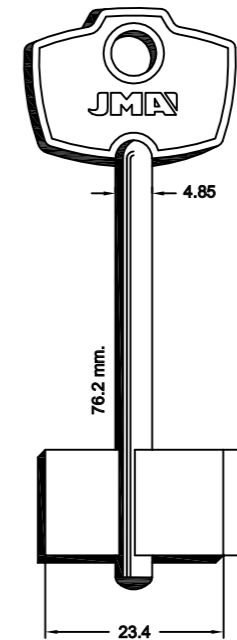

CRT-7G

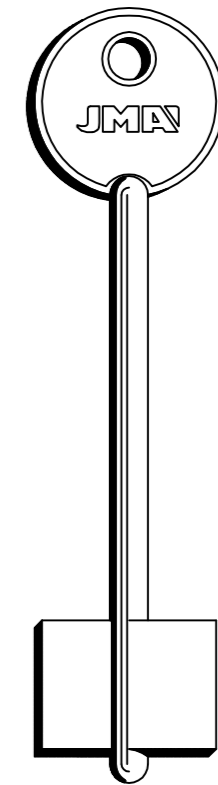

CRT-8G

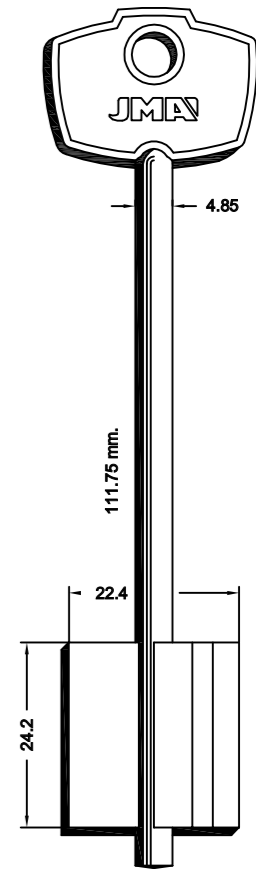

CRT-11G

Concerning the marks and commercial denominations see legal warning.
 Concerniente a las marcas y denominaciones comerciales ver aviso legal.
 Marka eta izendapen komertzialiei dagokienez, ikus lege-oharra.
 Concernant les marques et denominations commerciales voir la note dans l'index.

FOR: CERUTTI®

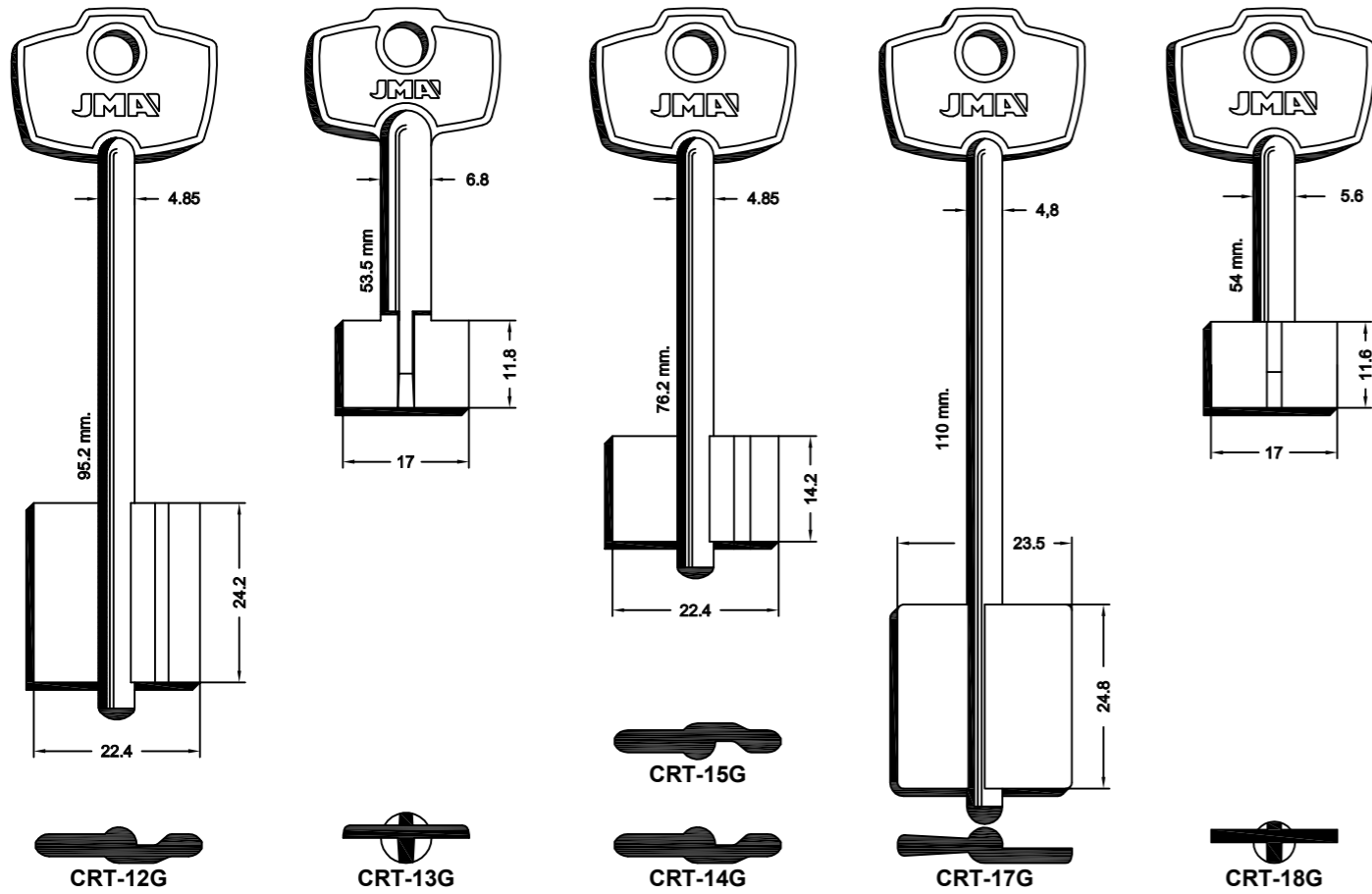

FOR: CISA®

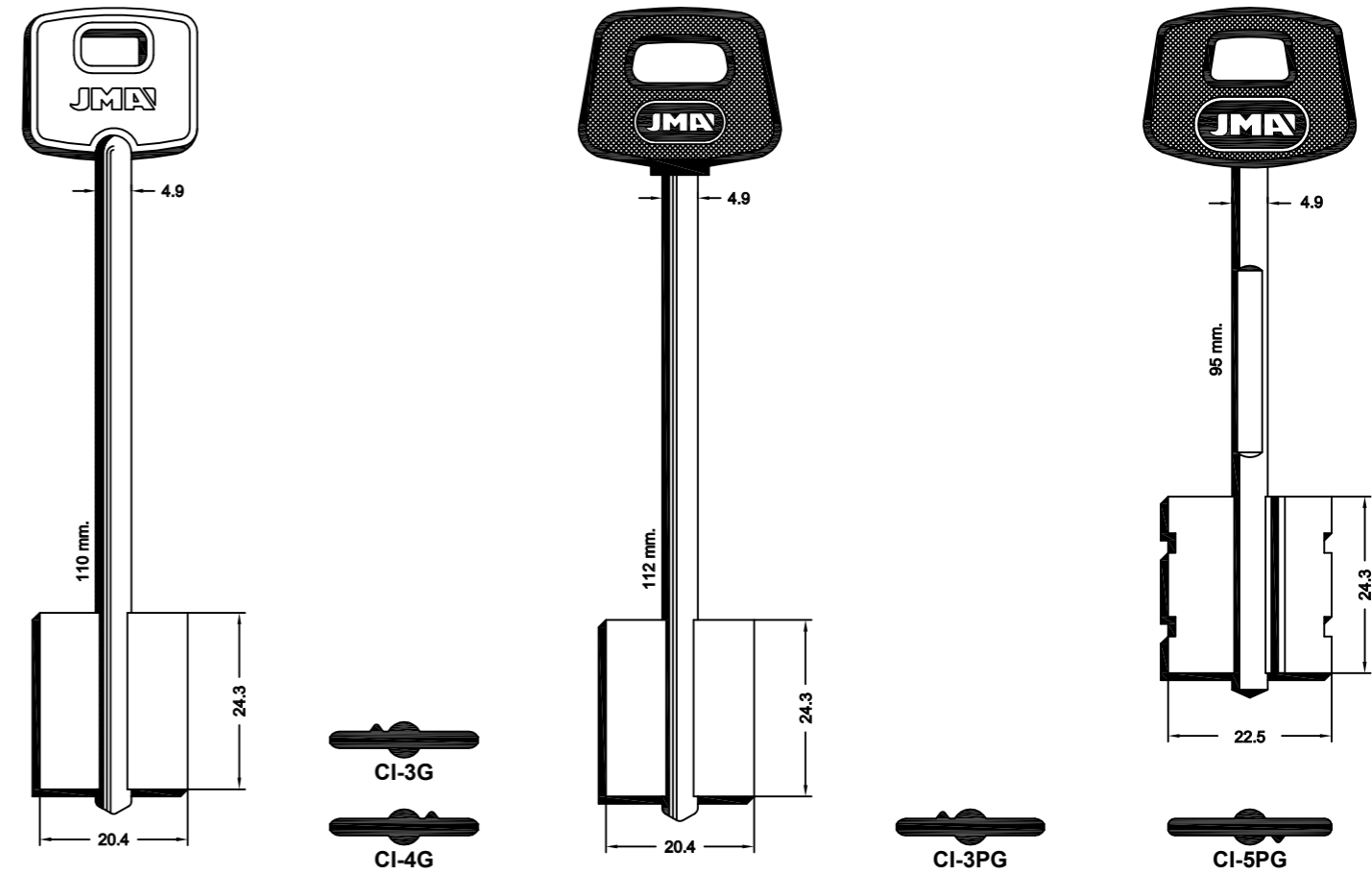

FOR: CHUBB®

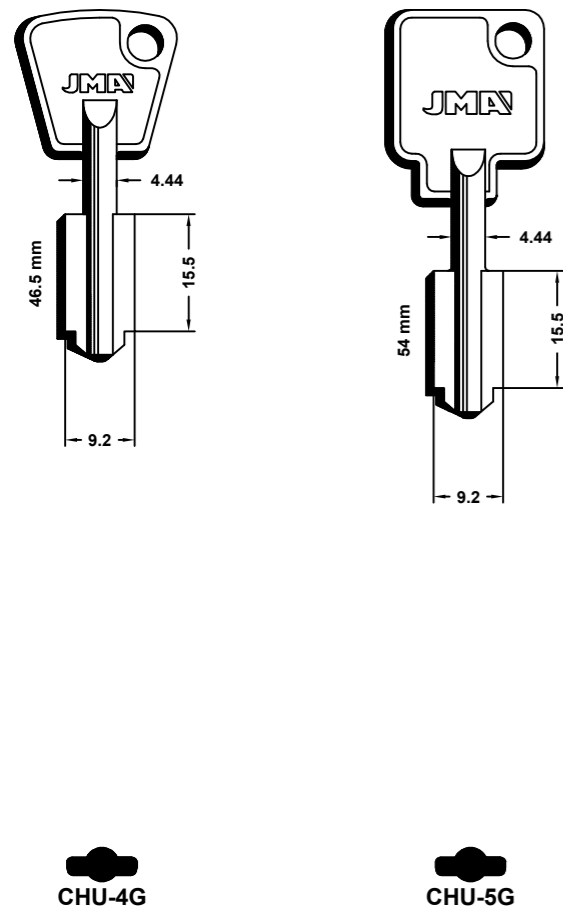

FOR: CISA®

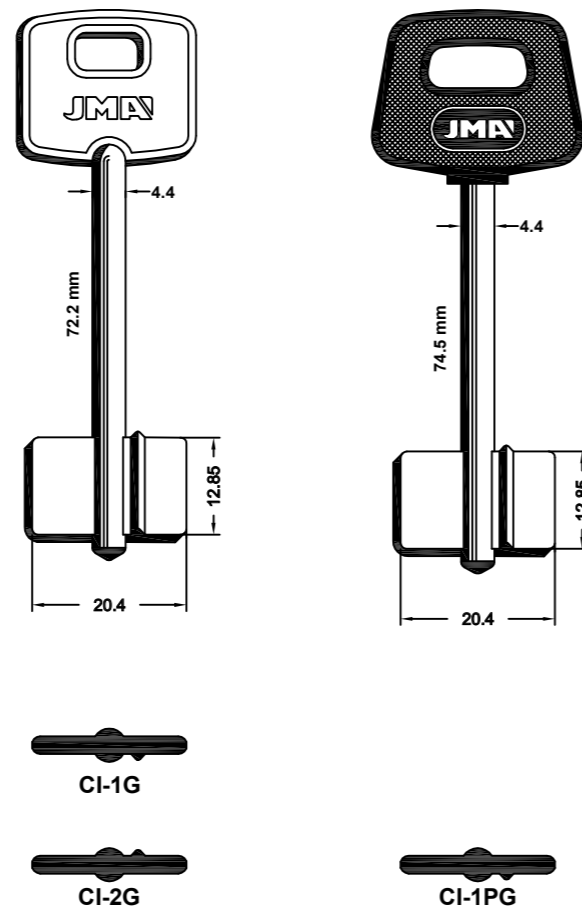

FOR: CISA®

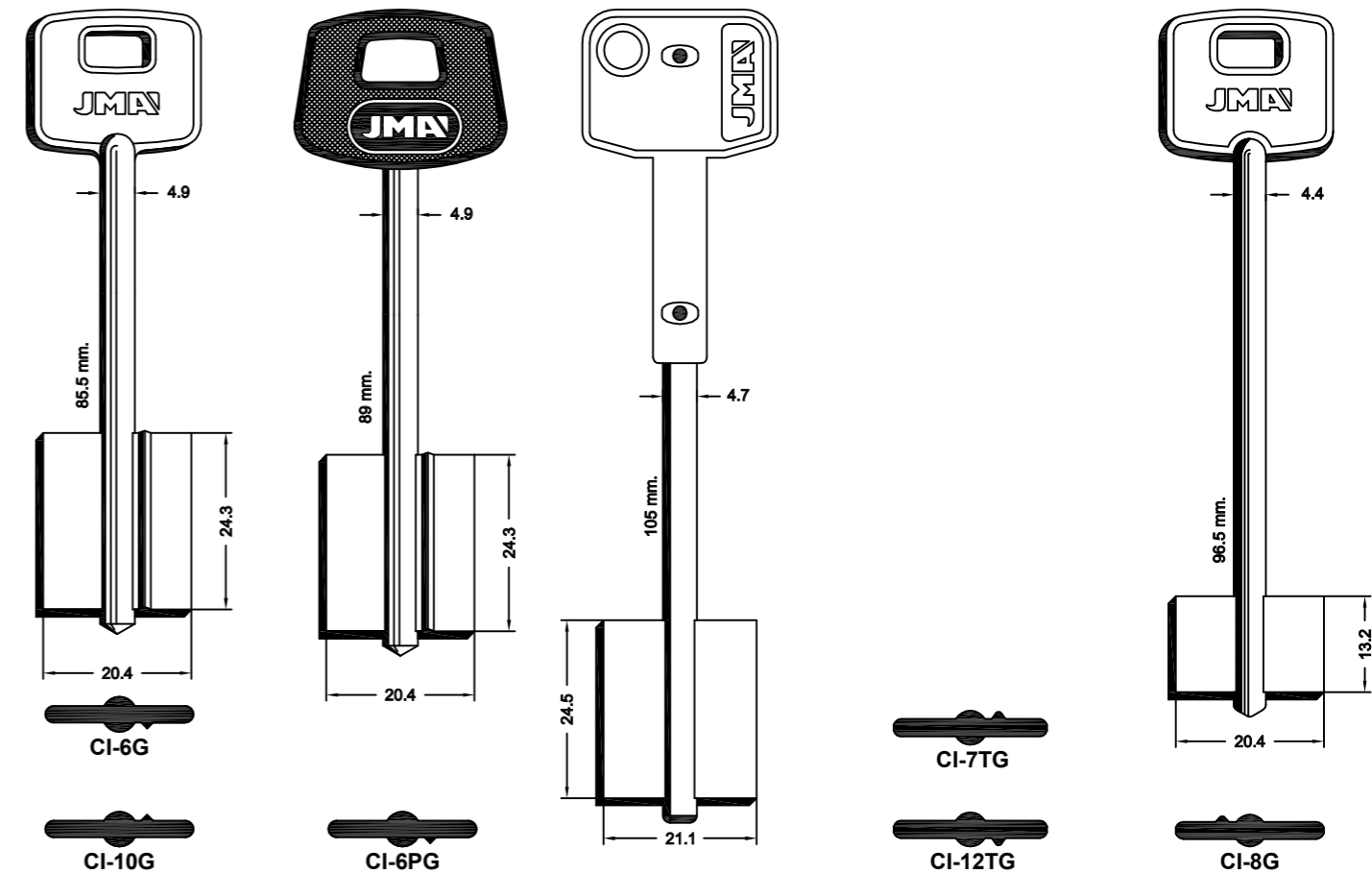

Concerning the marks and commercial denominations see legal warning.
 Concerniente a las marcas y denominaciones comerciales ver aviso legal.
 Marka eta izendapen komertzialiei dagokienez, ikus lege-oharra.
 Concernant les marques et dénominations commerciales voir la note dans l'index.

JMA® Opening the future

JMA® Opening the future

Beziehen auf die Marke und Handelsname sehen Sie die Notiz im Index.
 Relativamente às marcas e denominações comerciais, ver aviso legal.
 Jeśli chodzi o znaki i nazwy handlowe, patrz Informacje prawne.

FOR: CISA®

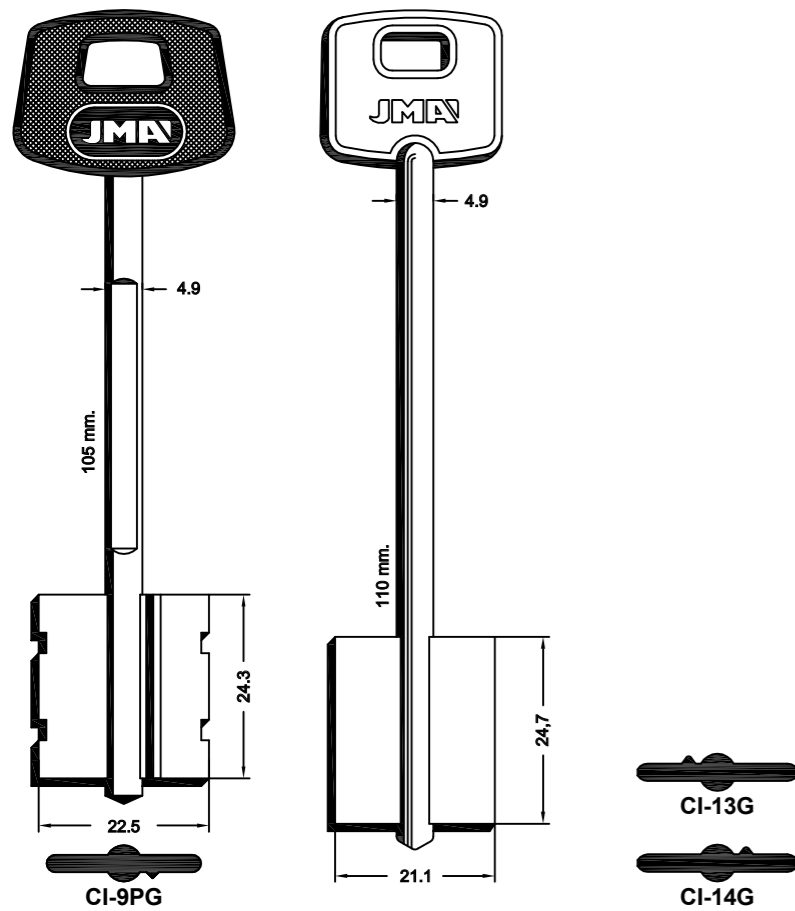

FOR: CLASS®

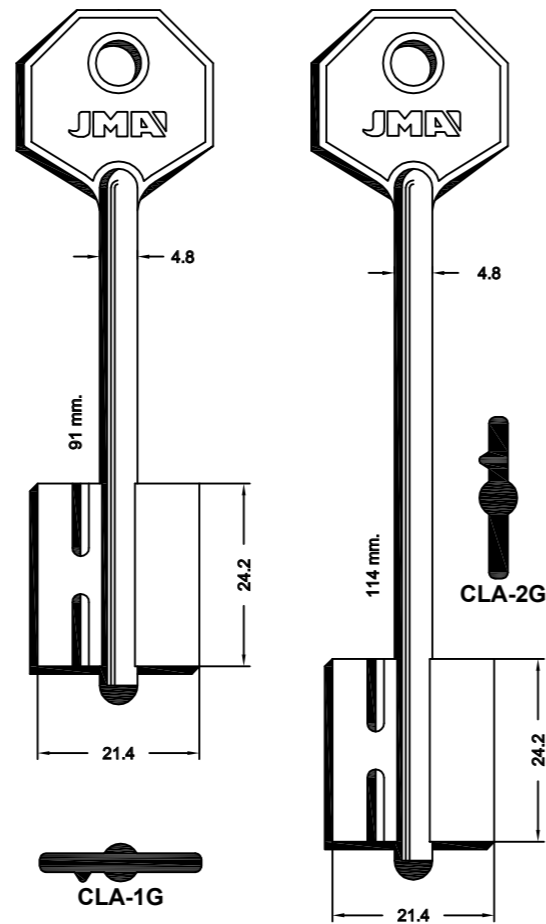

FOR: CR®

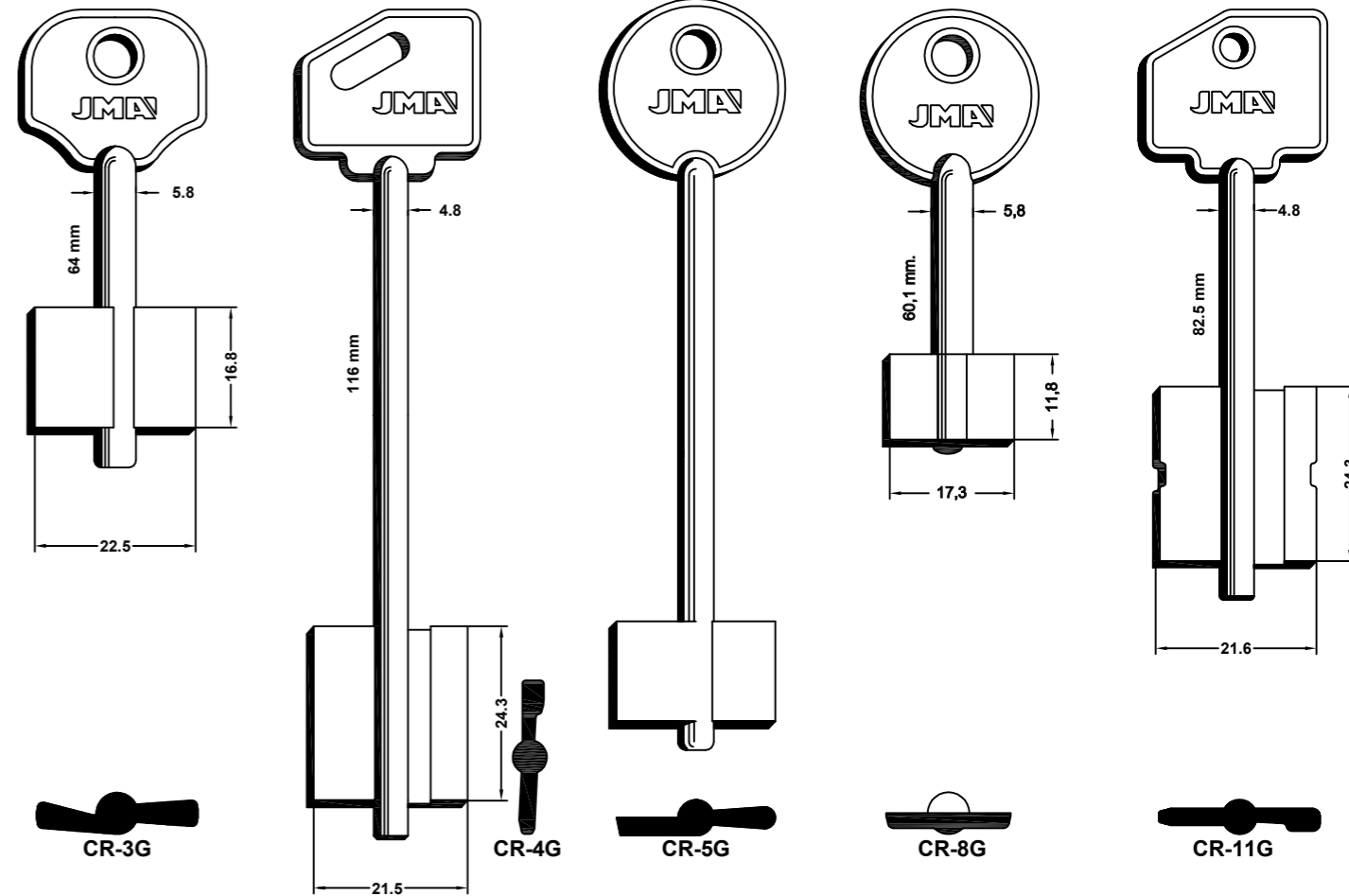

FOR: CLASS®

FOR: CORNI®

FOR: CR®

FOR: CR®

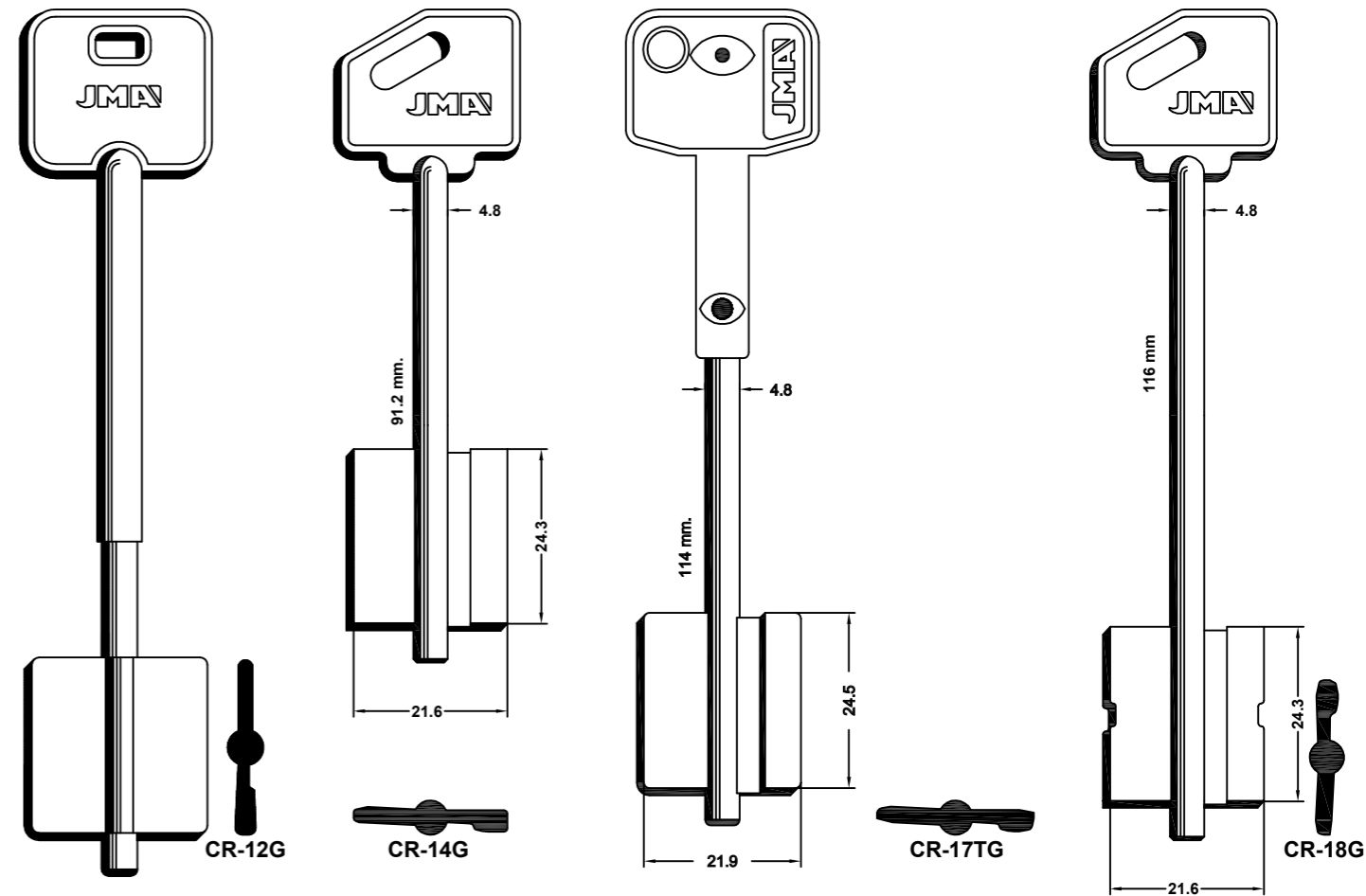
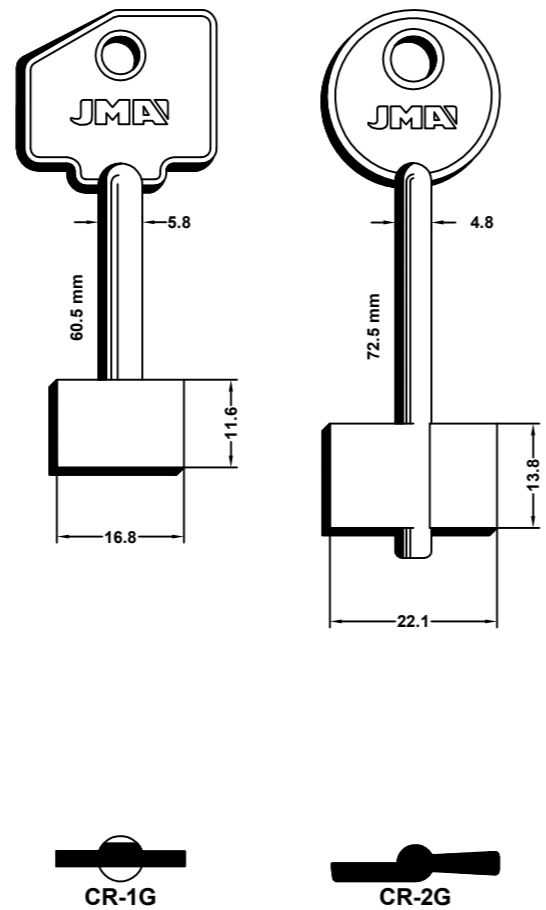
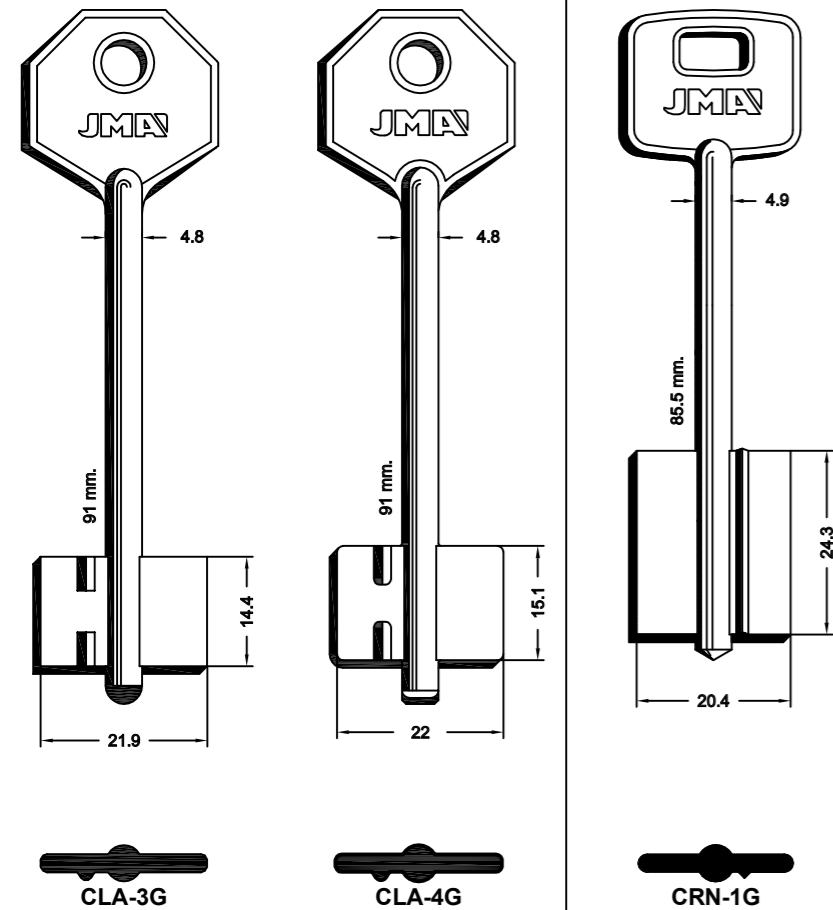

Concerning the marks and commercial denominations see legal warning.
 Concerniente a las marcas y denominaciones comerciales ver aviso legal.
 Marka eta izendapen komertzialiei dagokienez, ikus lege-oharra.
 Concernant les marques et dénominations commerciales voir la note dans l'index.

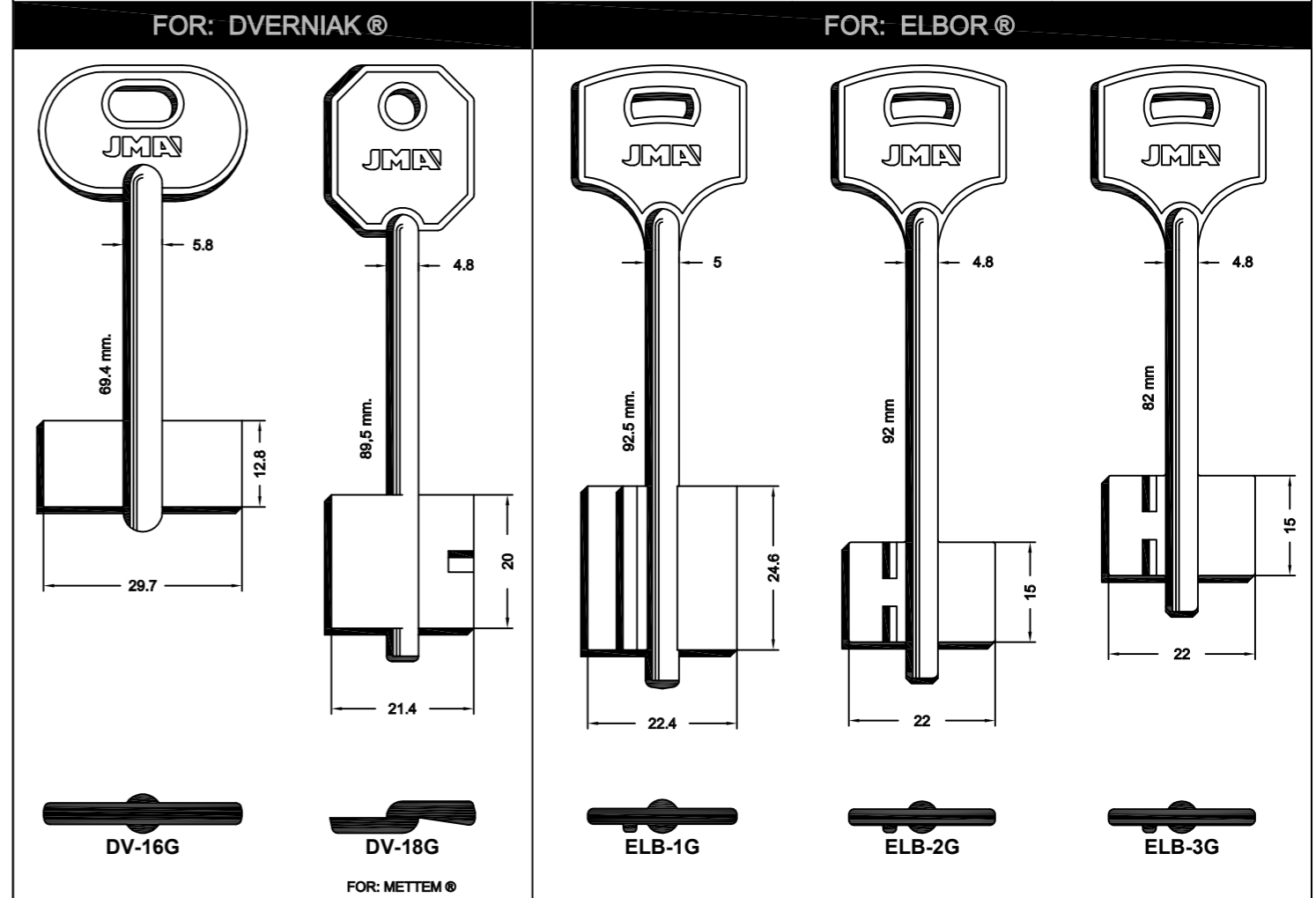
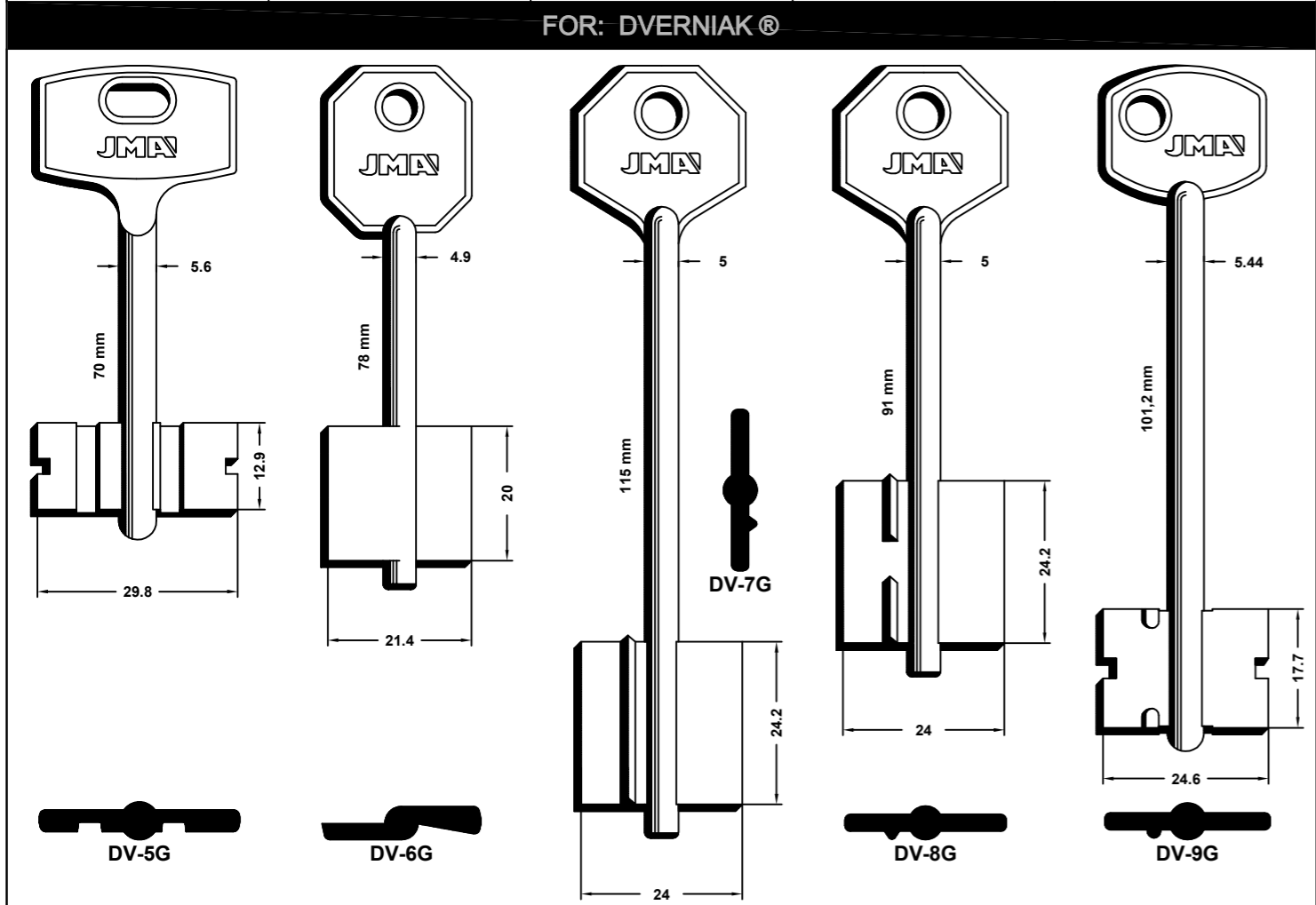
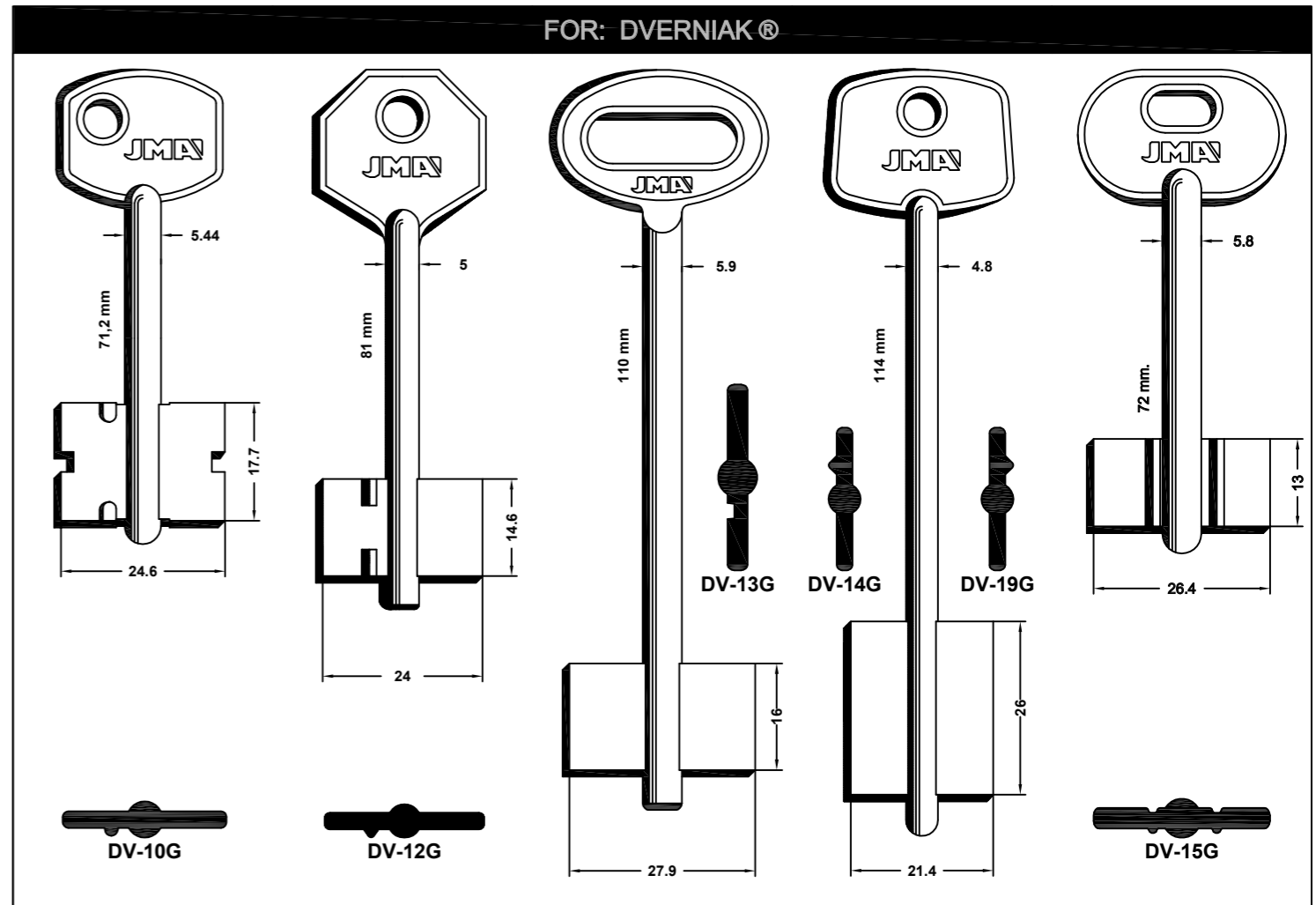
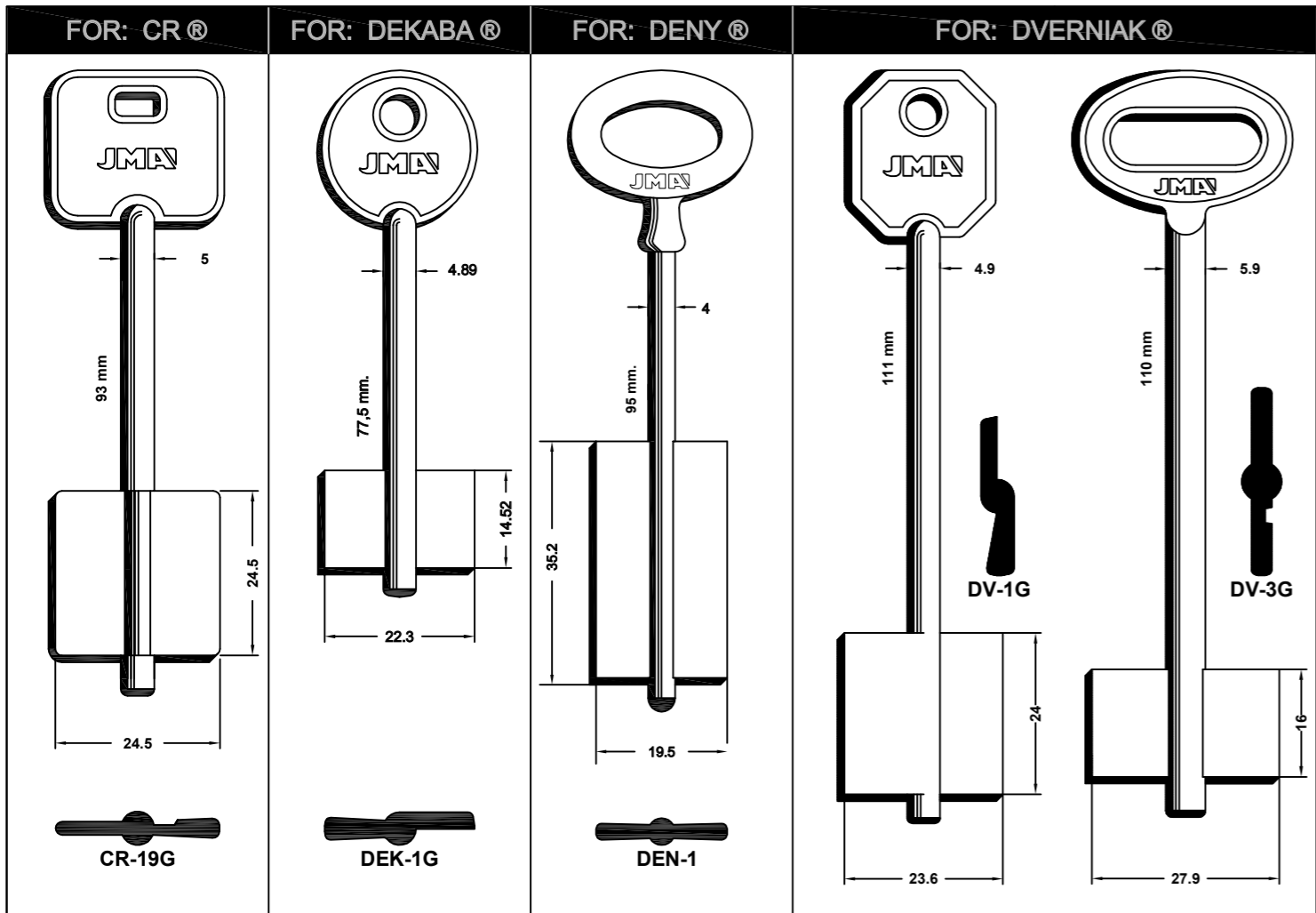

Concerning the marks and commercial denominations see legal warning.
 Concerniente a las marcas y denominaciones comerciales ver aviso legal.
 Marka eta izendapen komertzialiei dagokienez, ikus lege-oharra.
 Concernant les marques et dénominations commerciales voir la note dans l'index.

JMA Opening the future

JMA Opening the future

Beziehen auf die marke und handelsname sehen sie die notiz im index.
 Relativamente às marcas e denominações comerciais, ver aviso legal.
 Jeśli chodzi o znaki i nazwy handlowe, patrz Informacje prawne.

FOR: ELZETT®

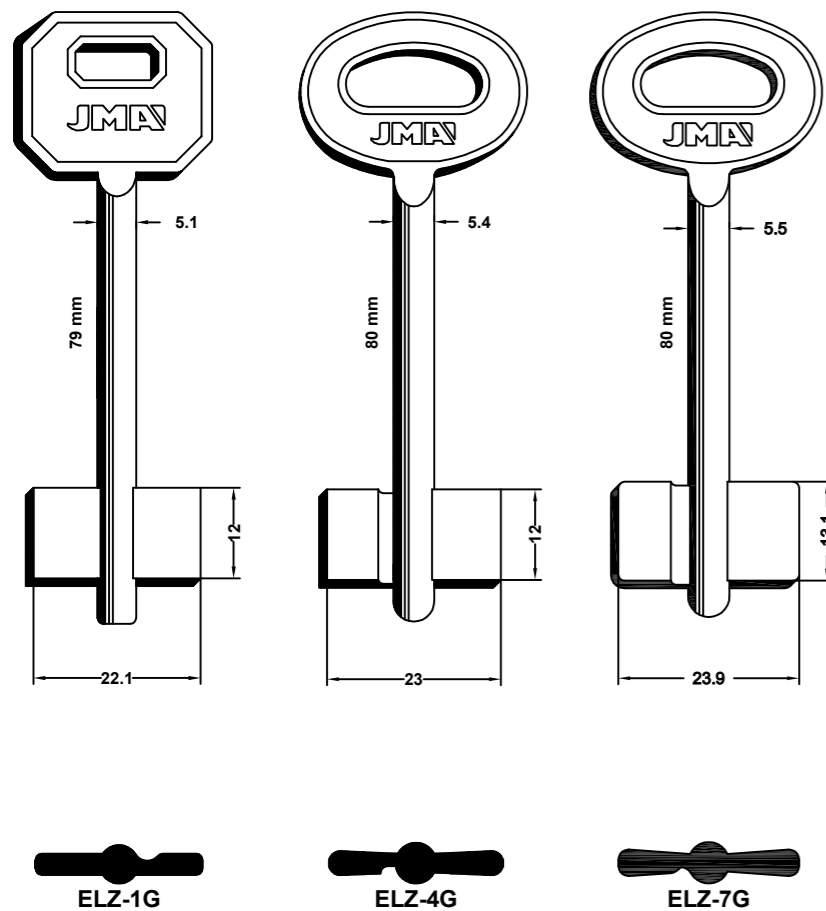

FOR: EREVAN®

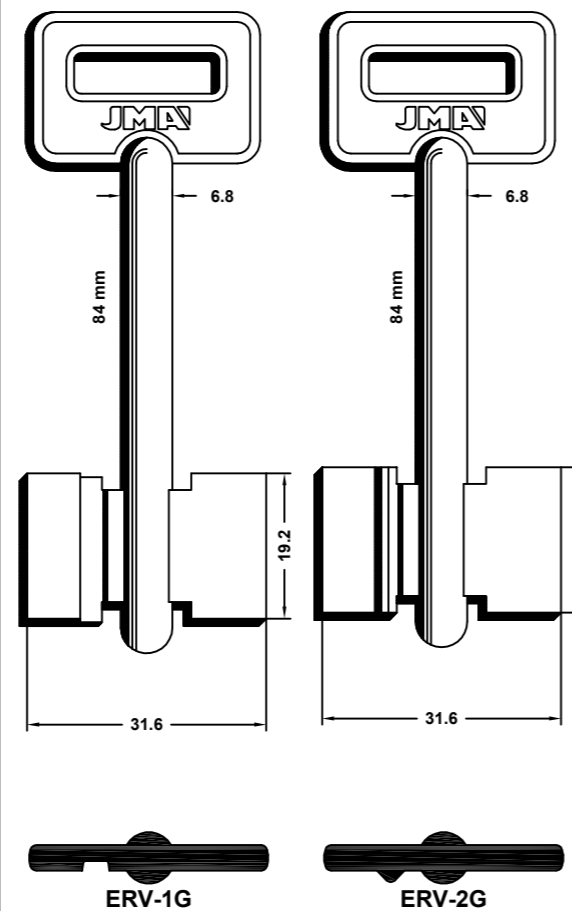

FOR: ESETY®

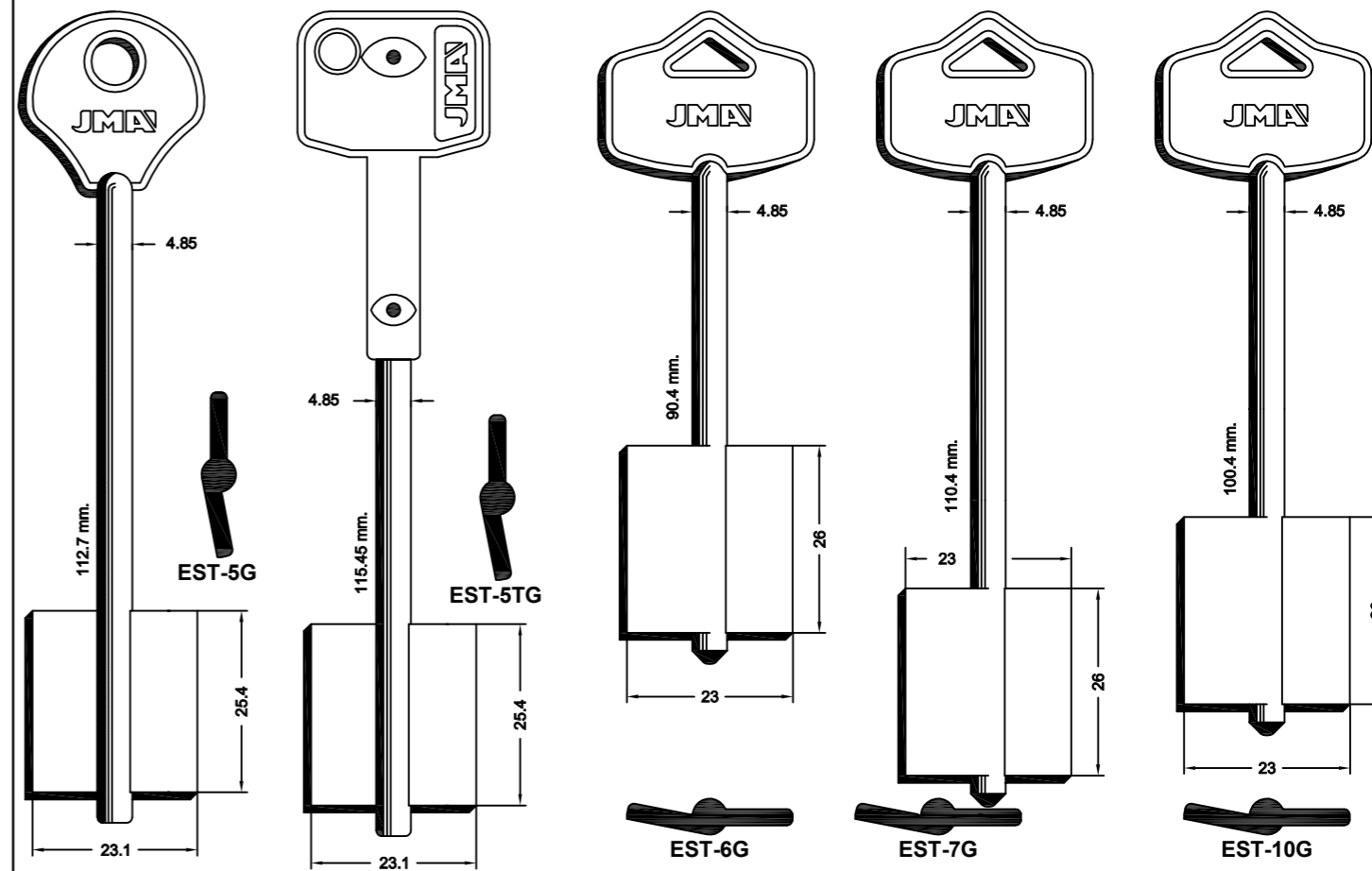

FOR: EREVAN®

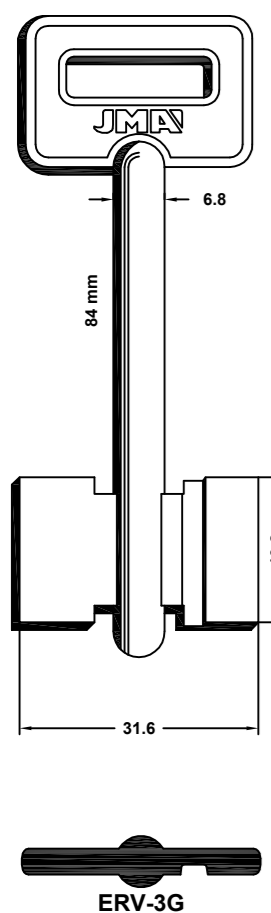

FOR: ESETY®

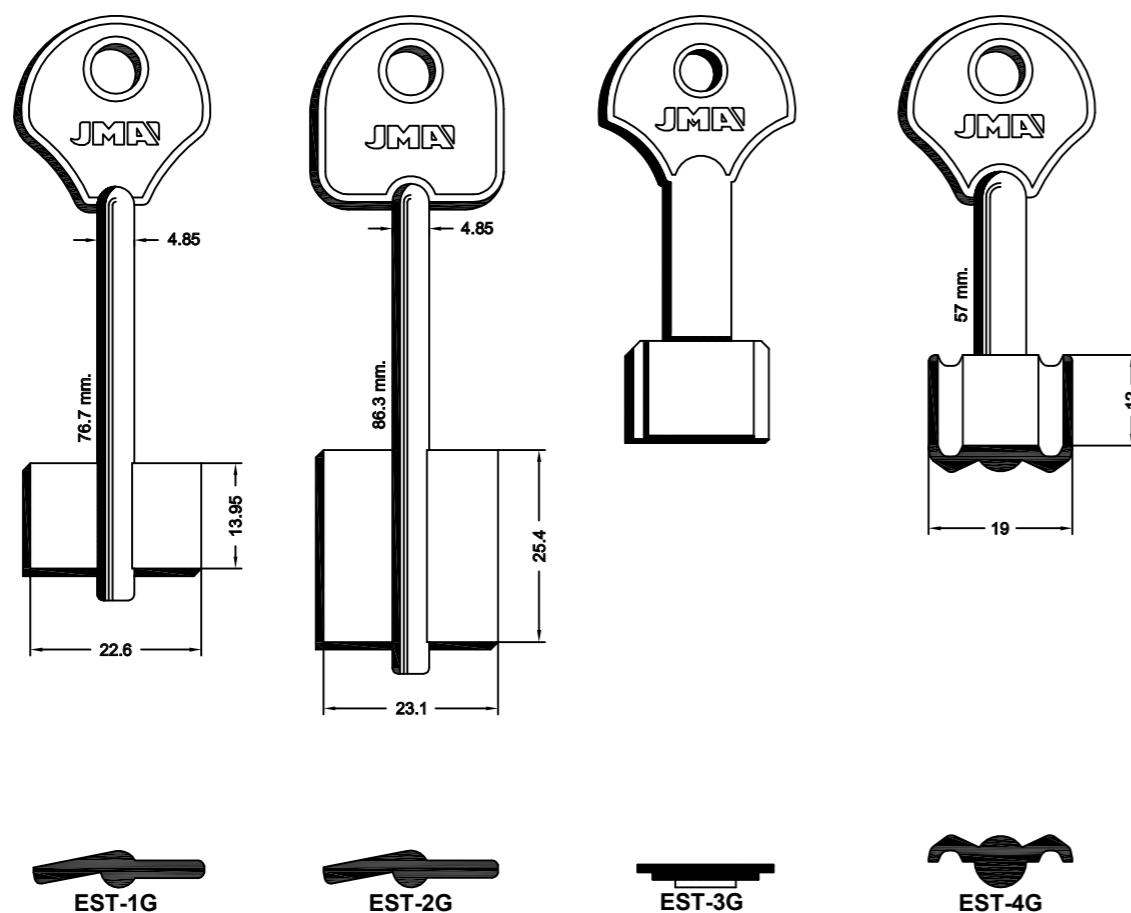

FOR: ESETY®

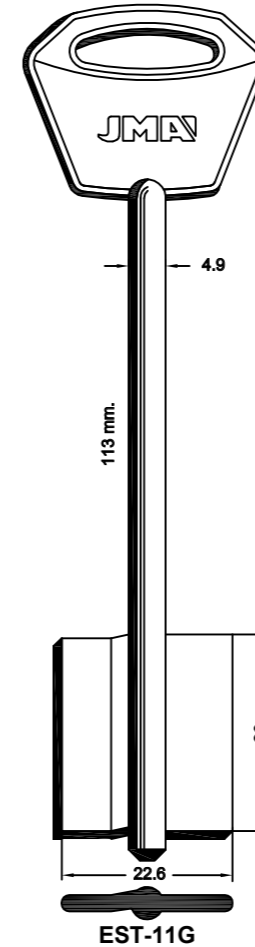

FOR: EUROTEMPLE®

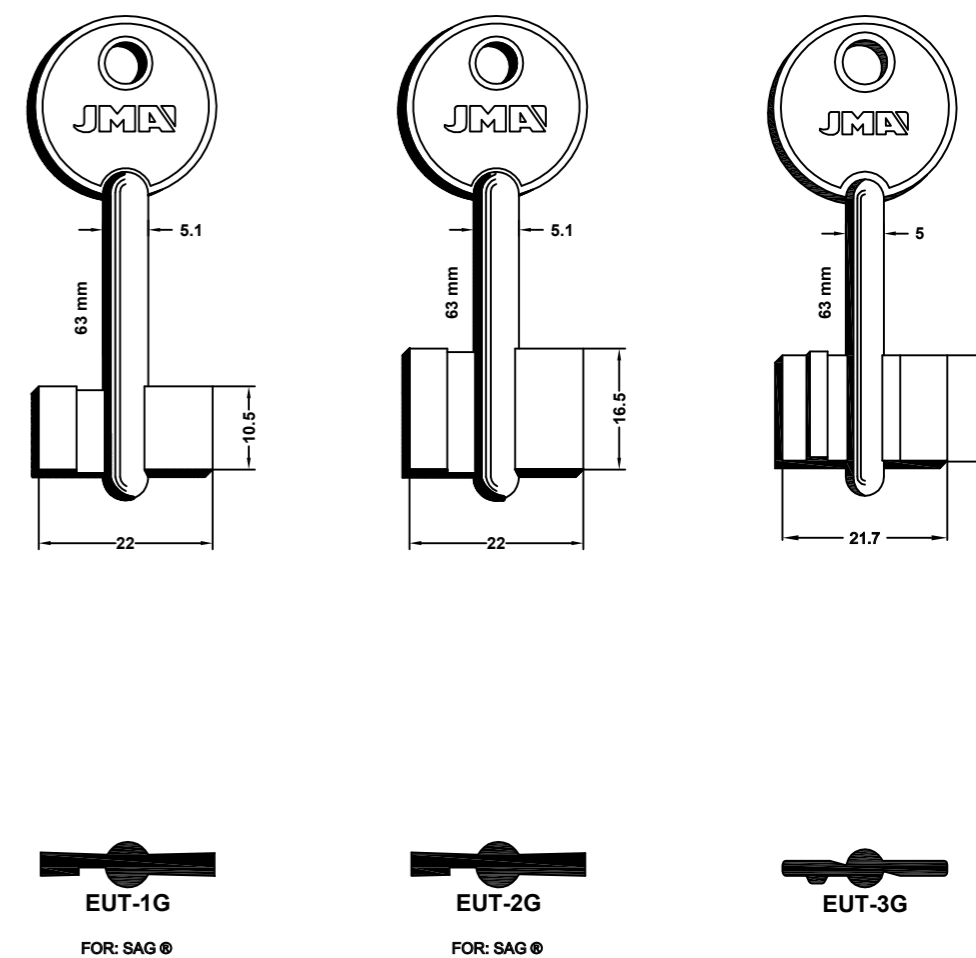

Concerning the marks and commercial denominations see legal warning.
 Concerniente a las marcas y denominaciones comerciales ver aviso legal.
 Marka eta izendapen komertzialiei dagokienez, ikus lege-oharra.
 Concernant les marques et dénominations commerciales voir la note dans l'index.

FOR: EZCURRA®

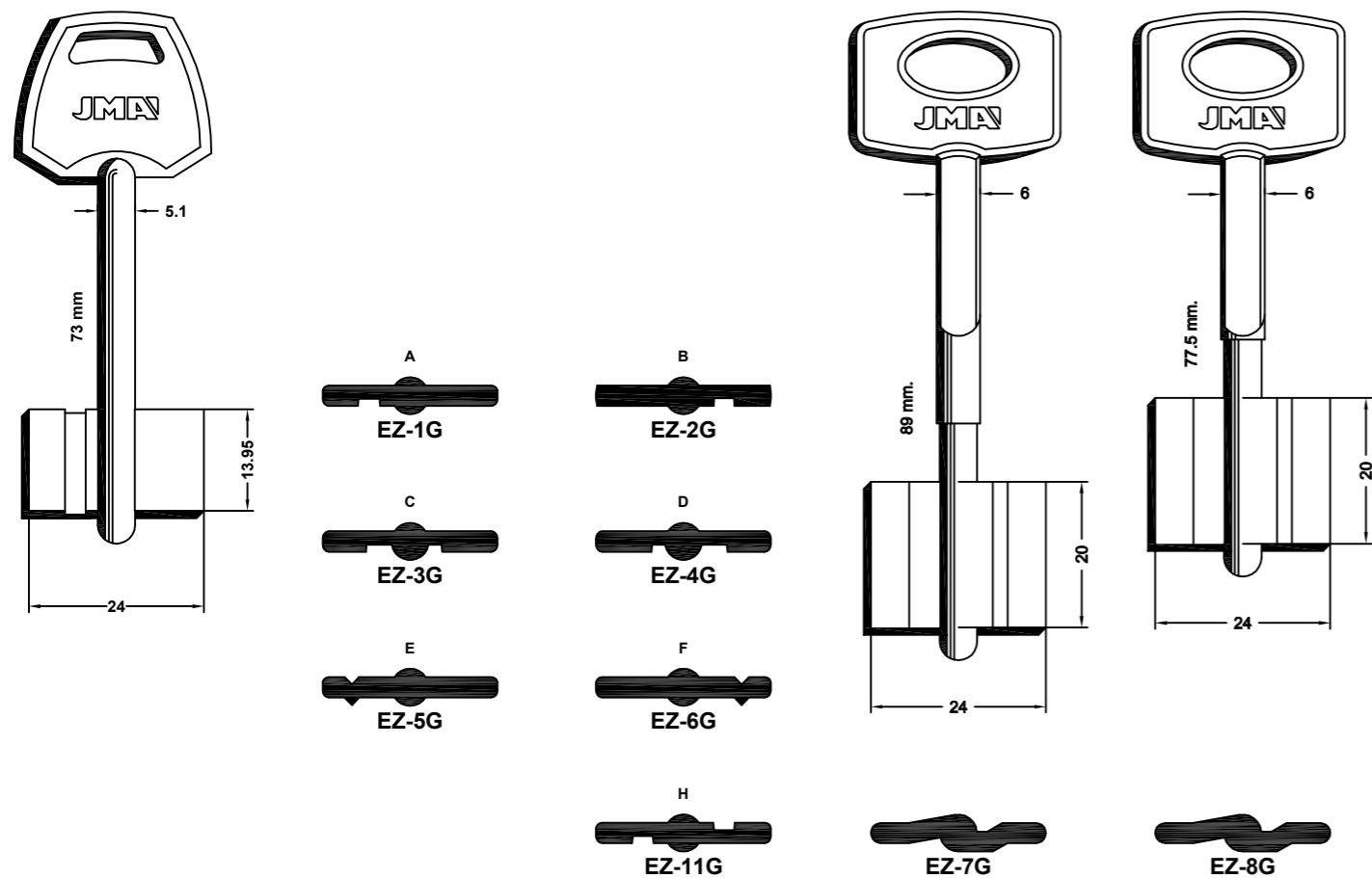

FOR: FAS®

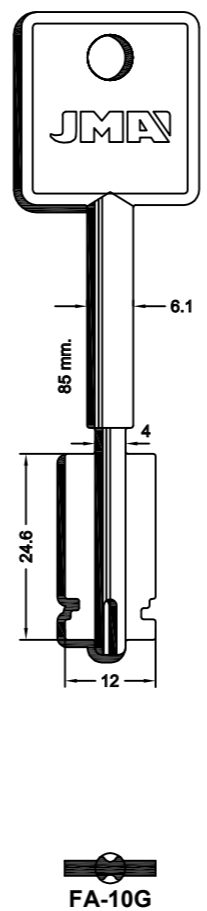

FOR: FEB®

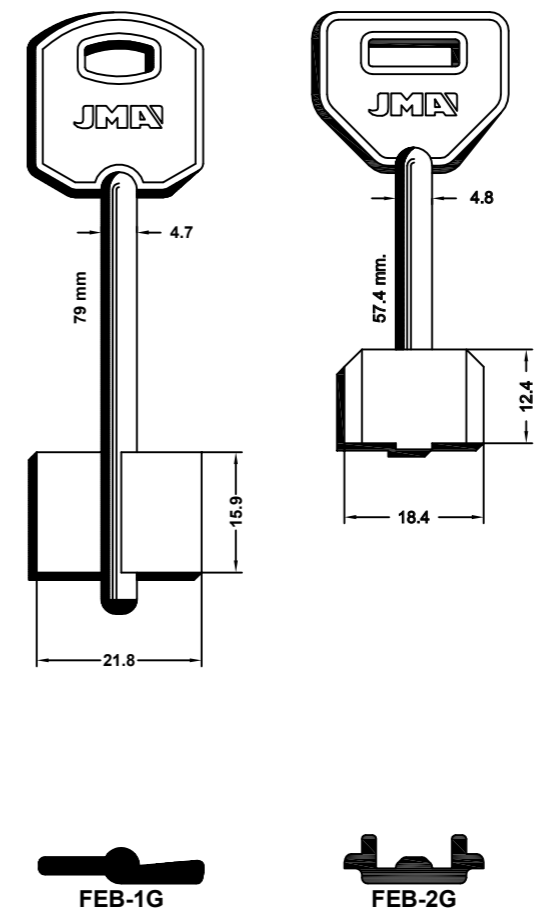

FOR: FETIS®

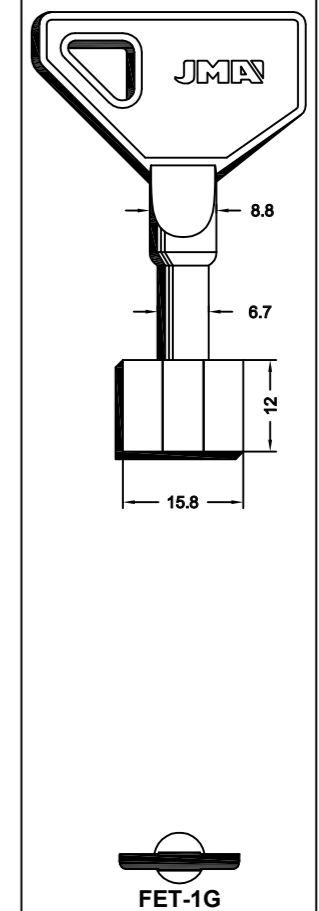

FOR: FIAM®

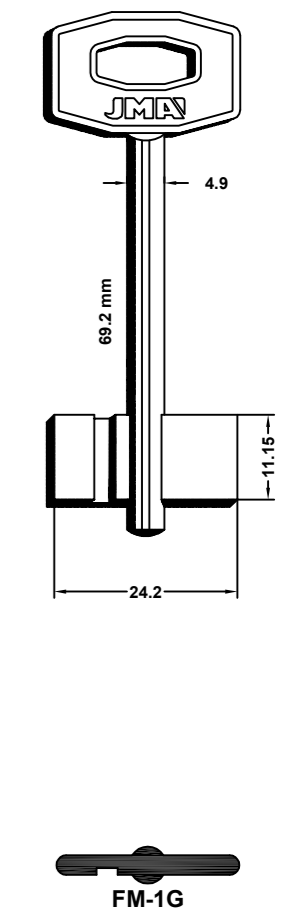

FOR: FAC®

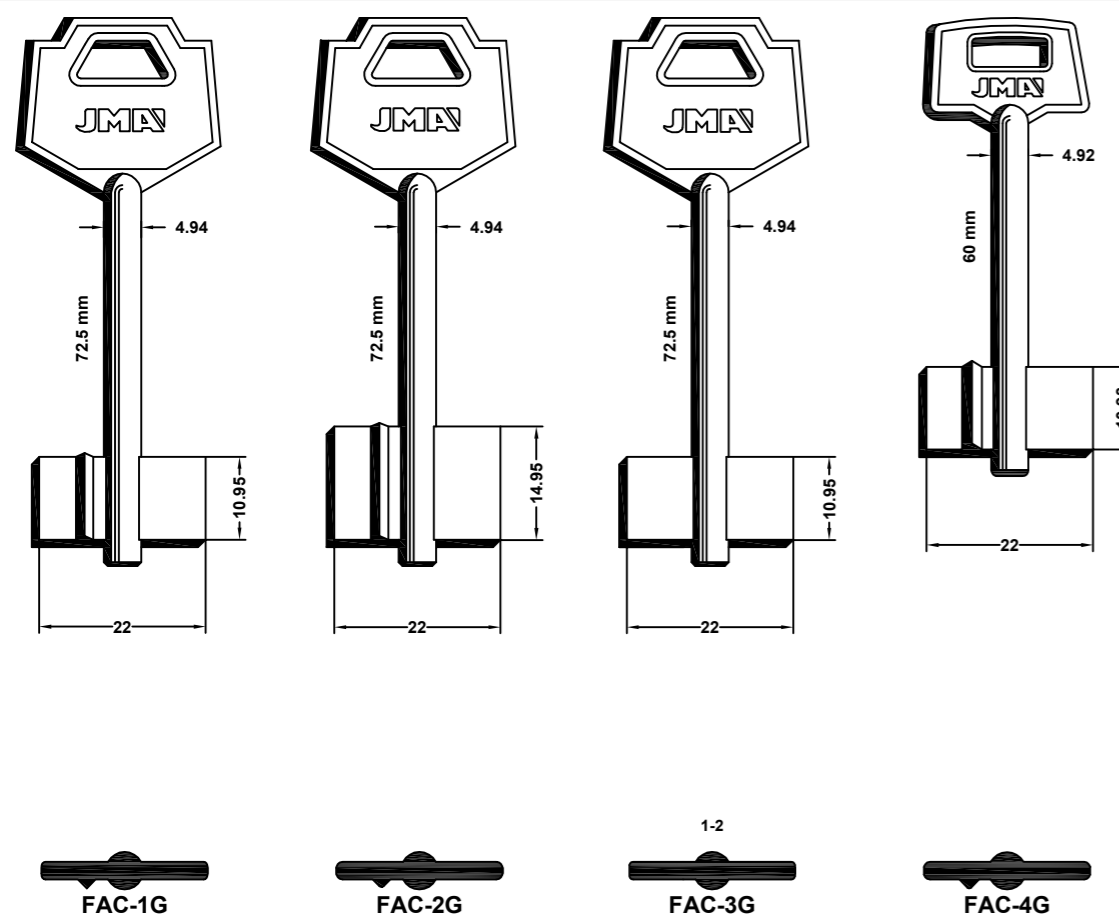

FOR: FAS®

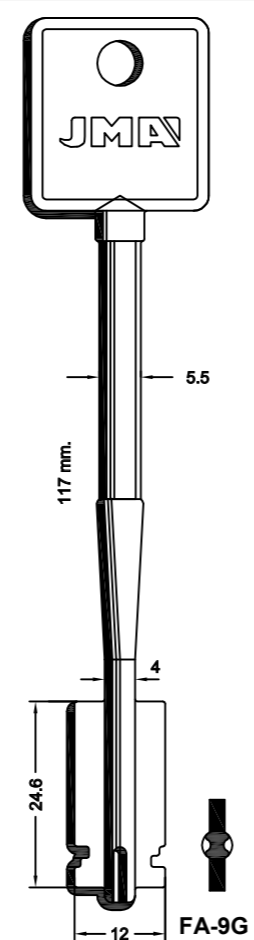

FOR: FIAM®

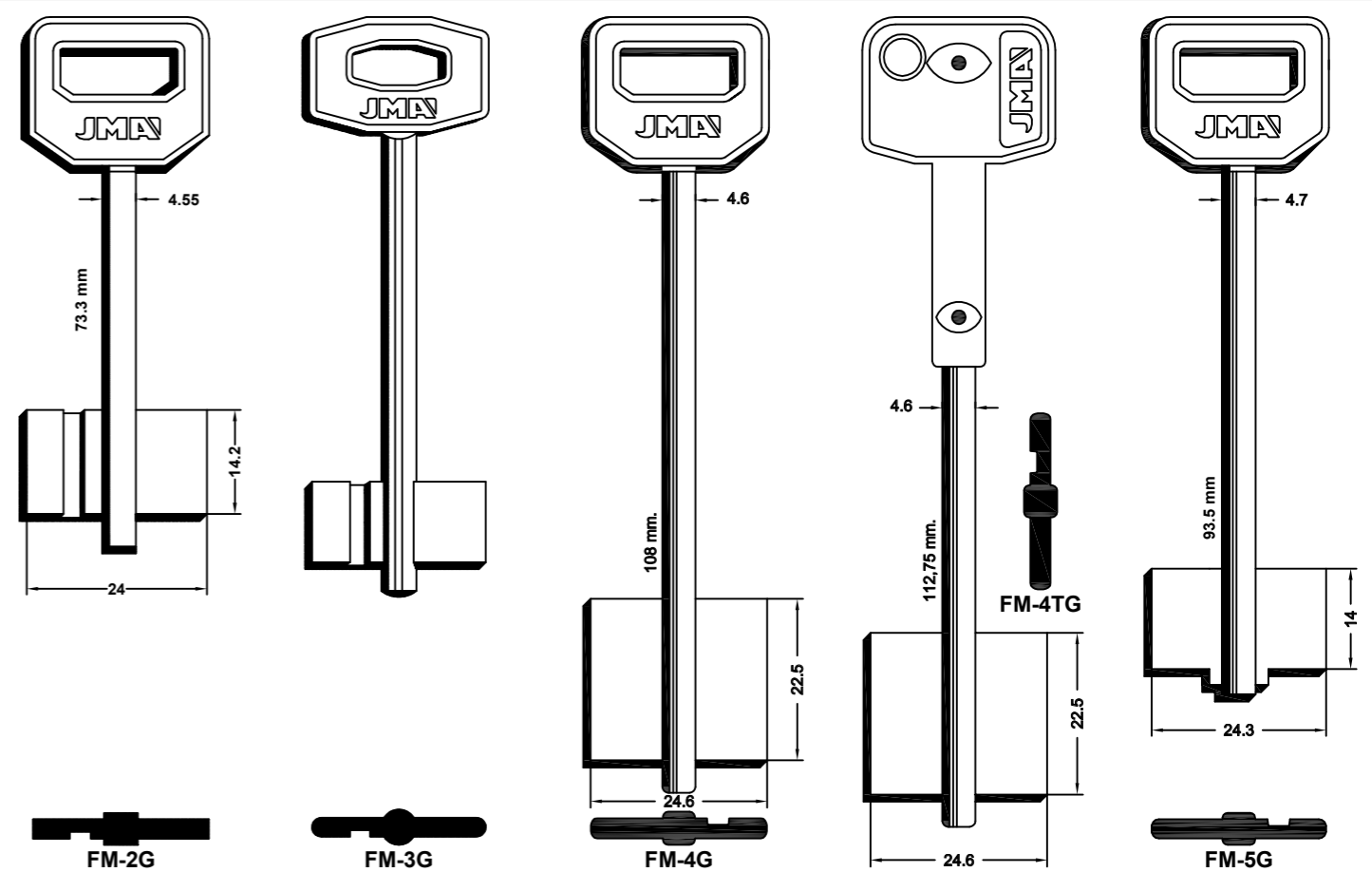

Concerning the marks and commercial denominations see legal warning.
 Concerniente a las marcas y denominaciones comerciales ver aviso legal.
 Marka eta izendapen komertzialiei dagokienez, ikus lege-oharra.
 Concernant les marques et dénominations commerciales voir la note dans l'index.

FOR: FIAM®

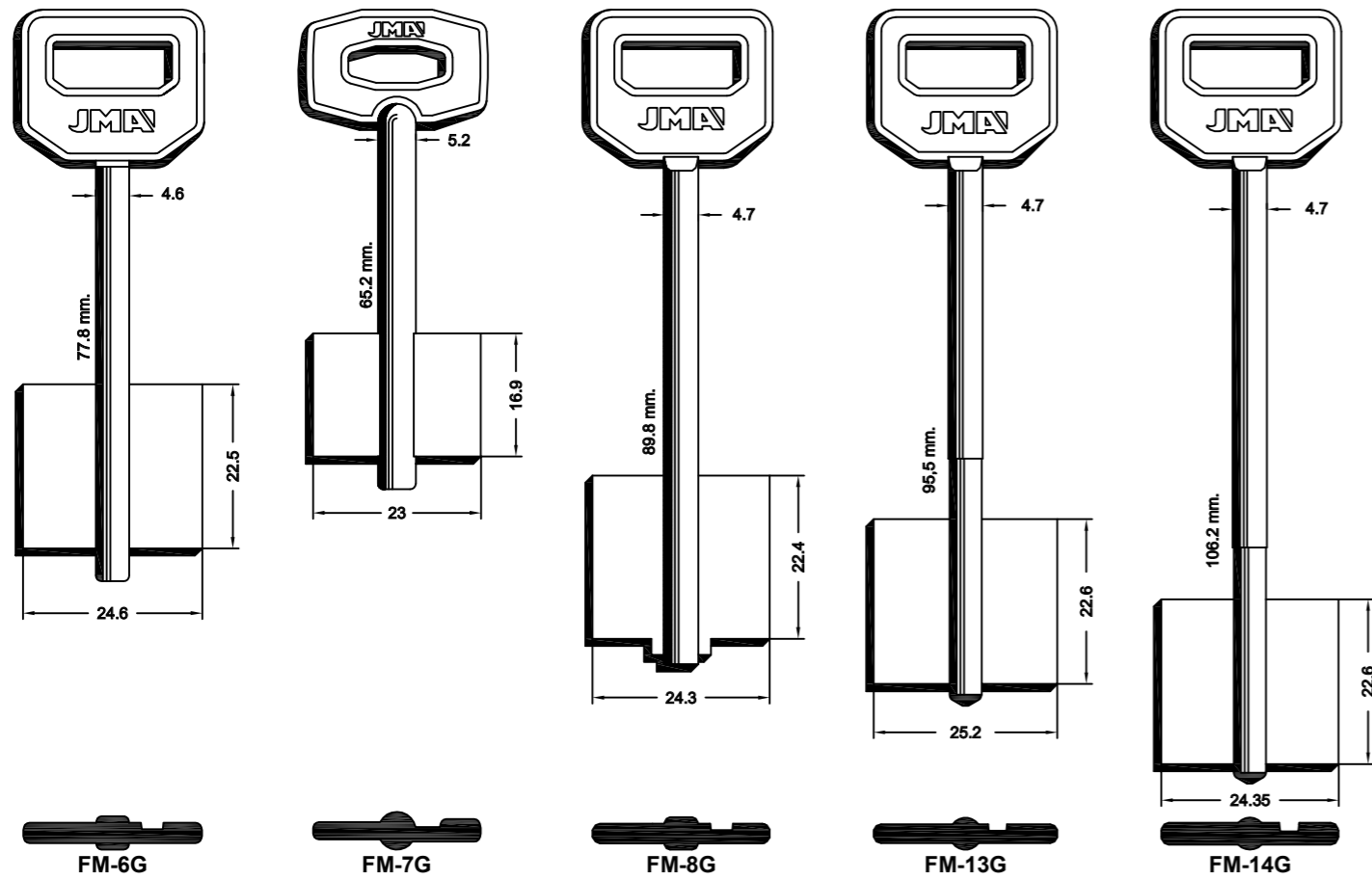

FOR: GARDIAN®

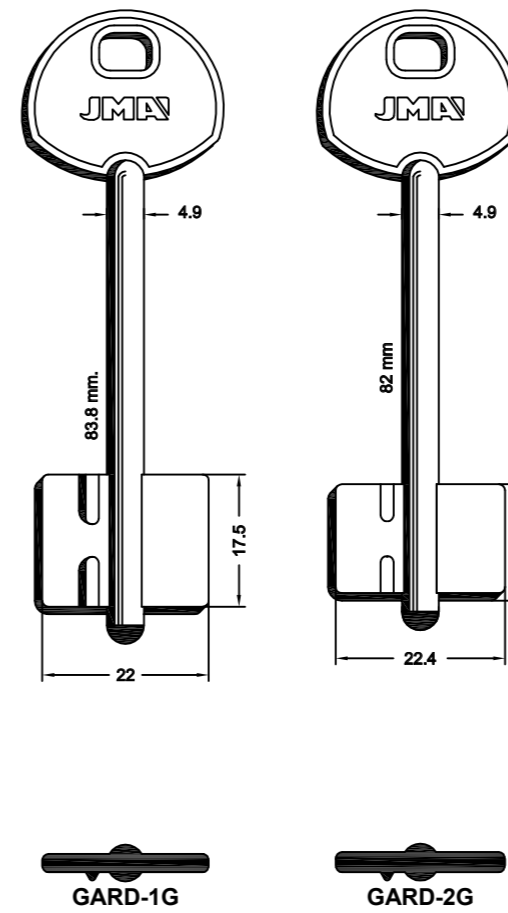

FOR: GERION®

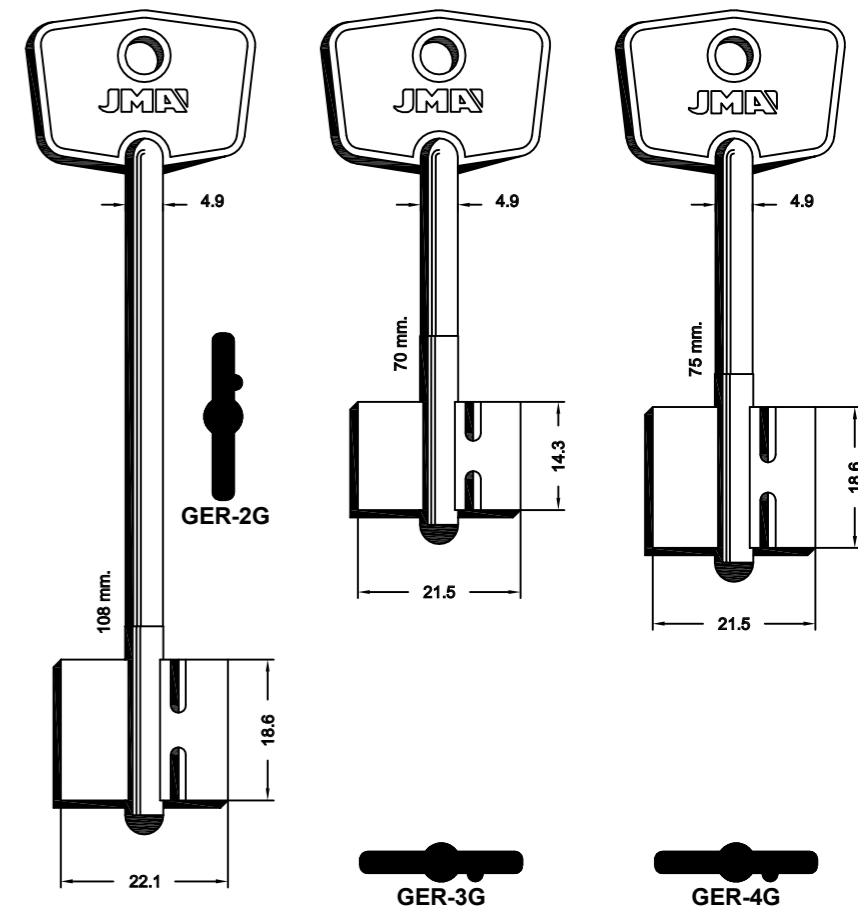

FOR: FIAM®

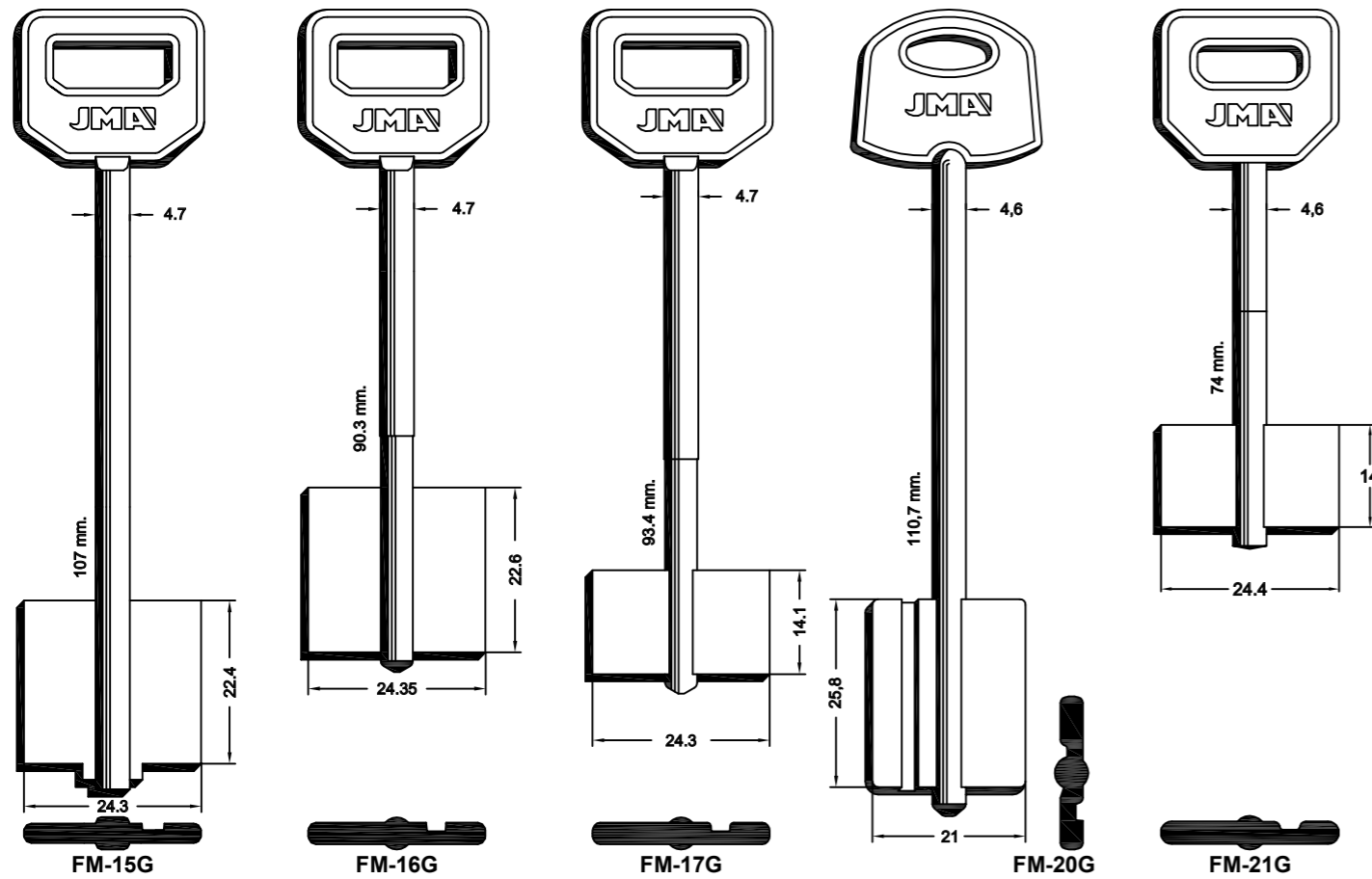

FOR: ISEO®

FOR: GERION®

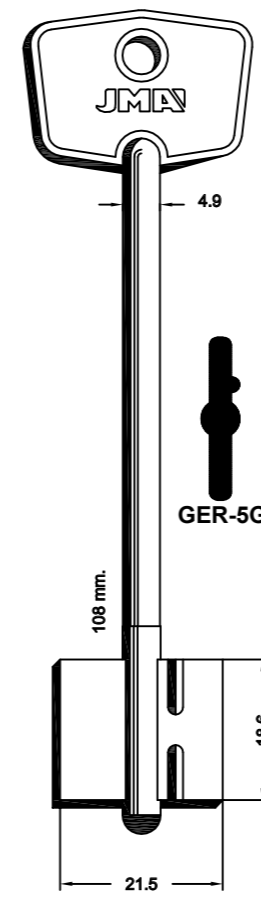

FOR: GIMAST®

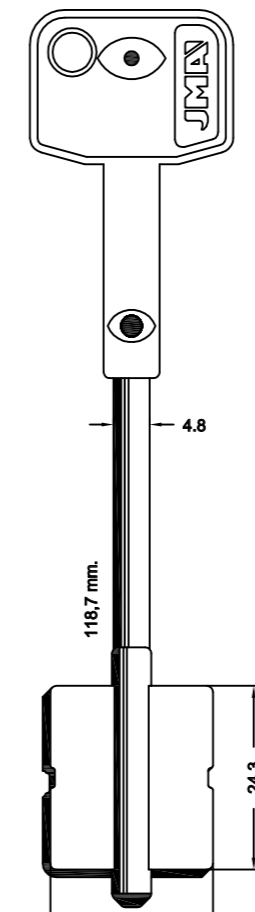

FOR: GIPIS®

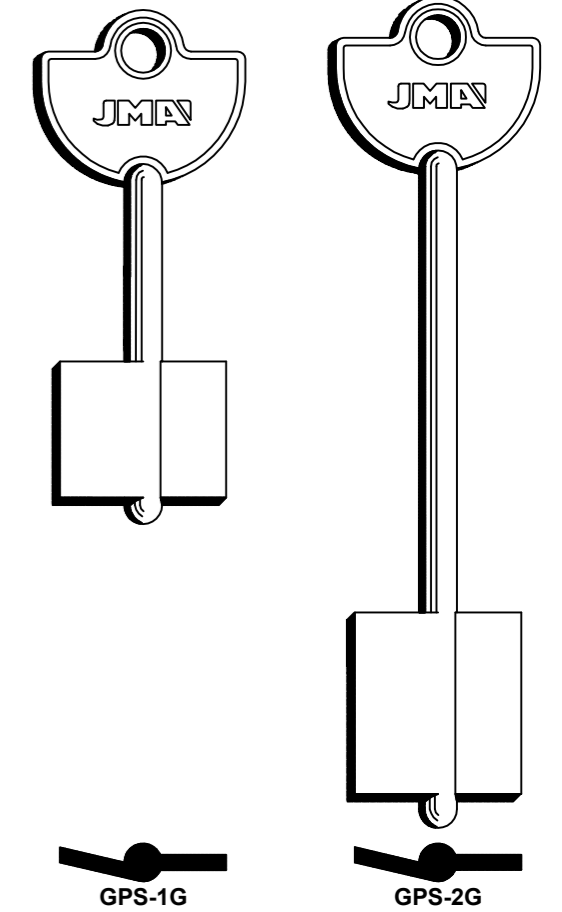

Concerning the marks and commercial denominations see legal warning.
 Concerniente a las marcas y denominaciones comerciales ver aviso legal.
 Marka eta izendapen komertzialiei dagokienez, ikus lege-oharra.
 Concernant les marques et denominations commerciales voir la note dans l'index.

JMA Opening the future

JMA Opening the future

Beziehen auf die marke und handelsname sehen sie die notiz im index.
 Relativamente às marcas e denominações comerciais, ver aviso legal.
 Jeśli chodzi o znaki i nazwy handlowe, patrz Informacje prawne.

FOR: GMG®

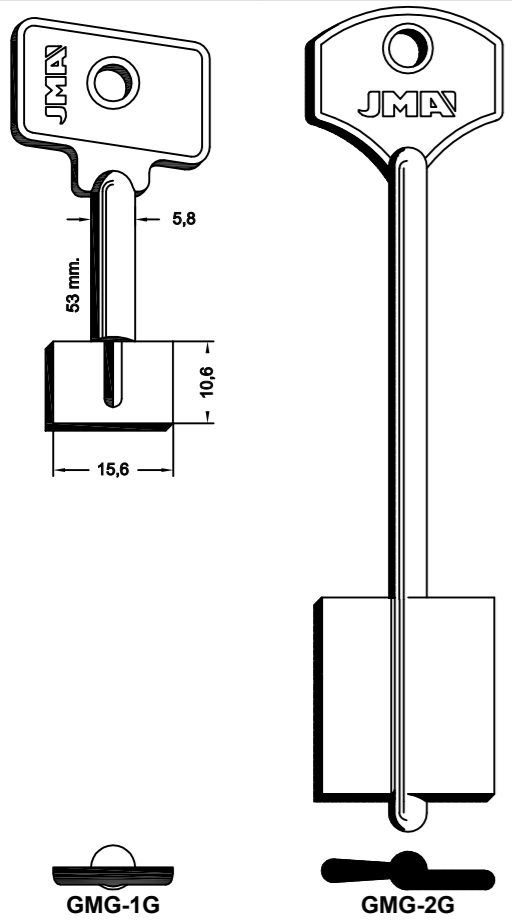

FOR: IDM®

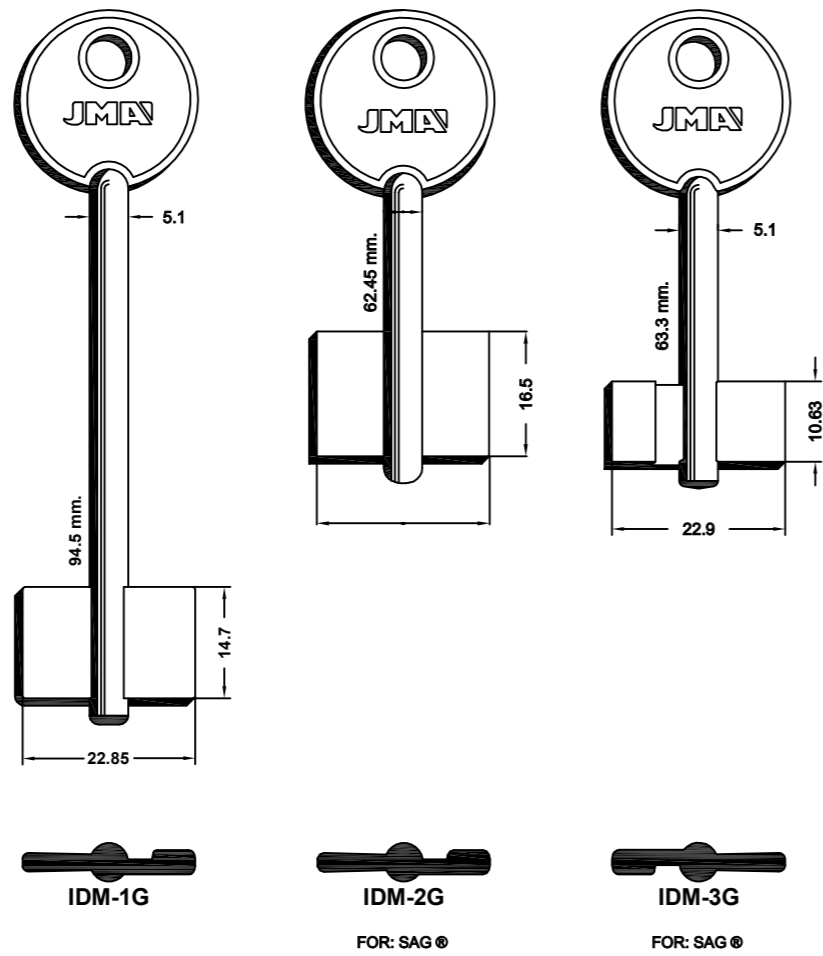

FOR: ISEO®

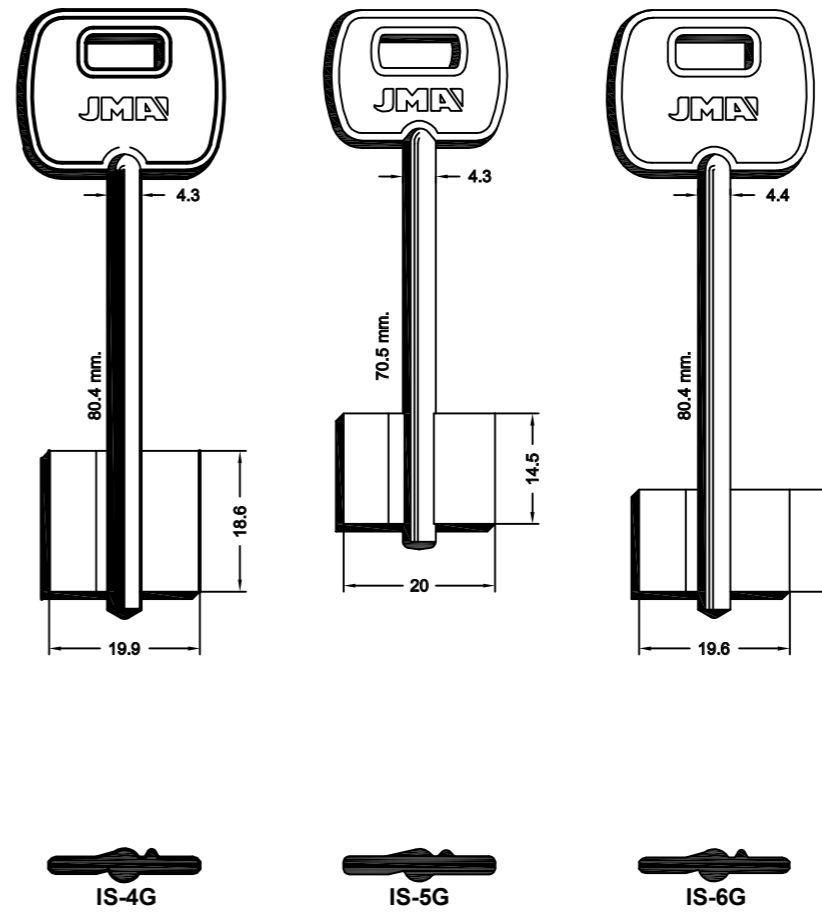

FOR: ITAL®

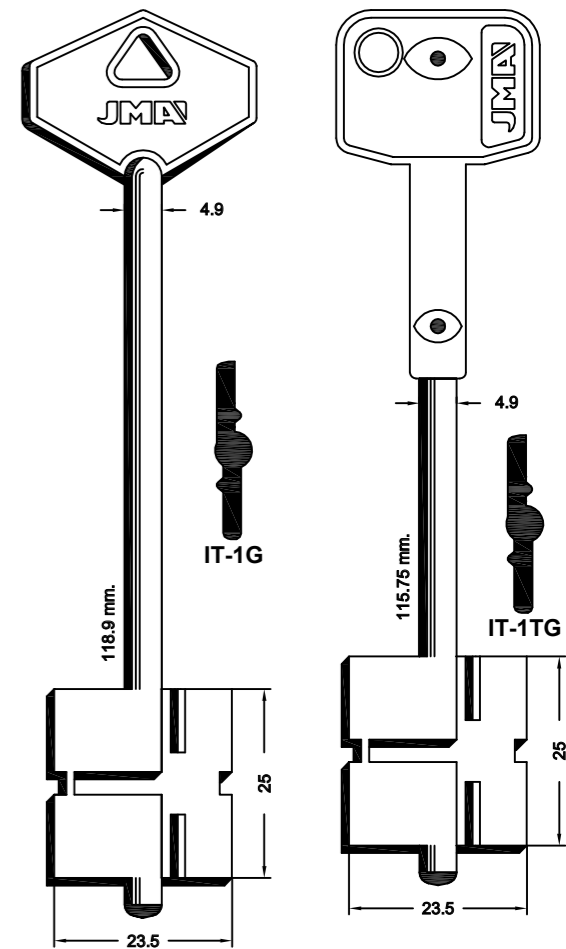

FOR: IDM®

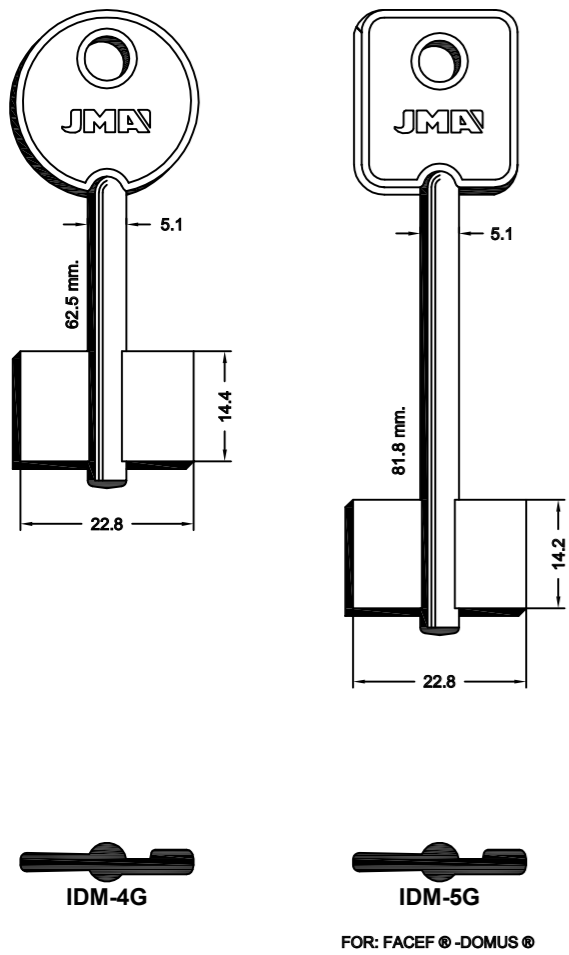

FOR: ISEO®

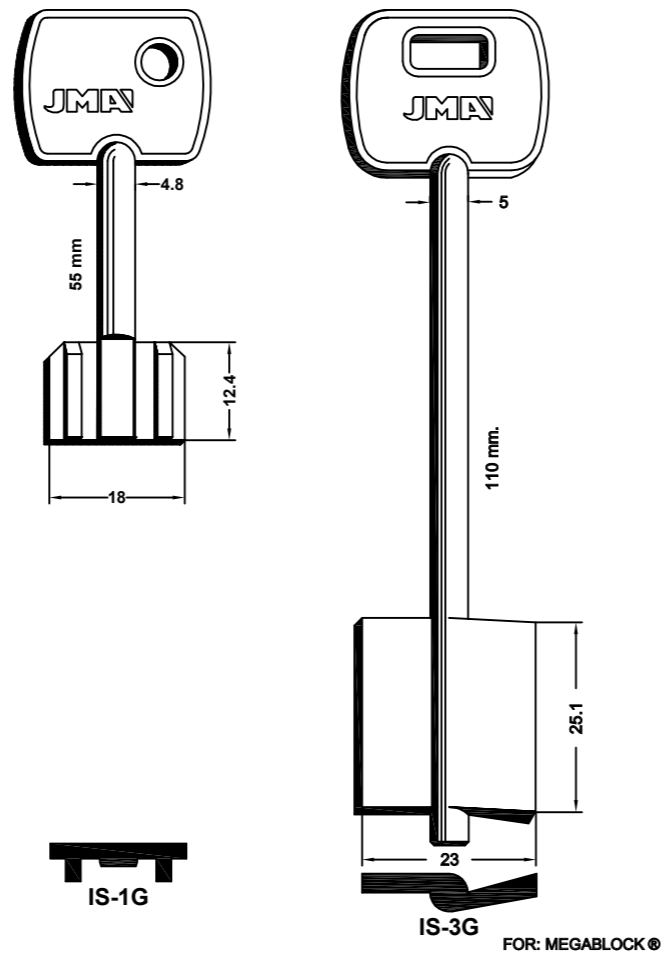

FOR: ITAL®

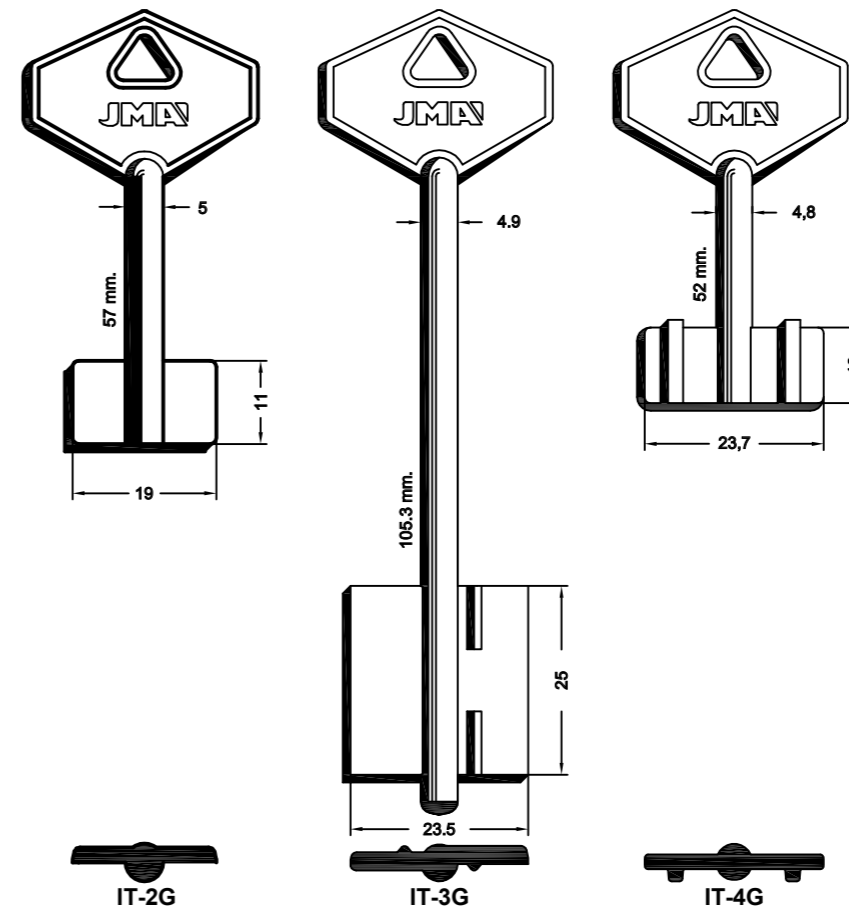

FOR: JUWEL®

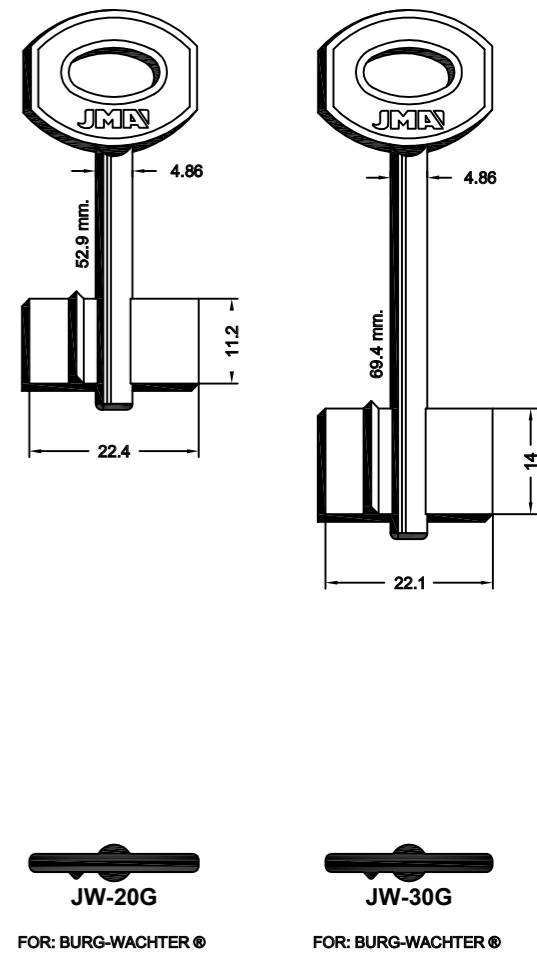

Concerning the marks and commercial denominations see legal warning.
 Concerniente a las marcas y denominaciones comerciales ver aviso legal.
 Marka eta izendapen komertzialiei dagokienez, ikus lege-oharra.
 Concernant les marques et dénominations commerciales voir la note dans l'index.

JMA Opening the future

JMA Opening the future

Beziehen auf die Marke und Handelsname sehen Sie die Notiz im Index.
 Relativamente às marcas e denominações comerciais, ver aviso legal.
 Jeśli chodzi o znaki i nazwy handlowe, patrz Informacje prawne.

FOR: JUWEL®

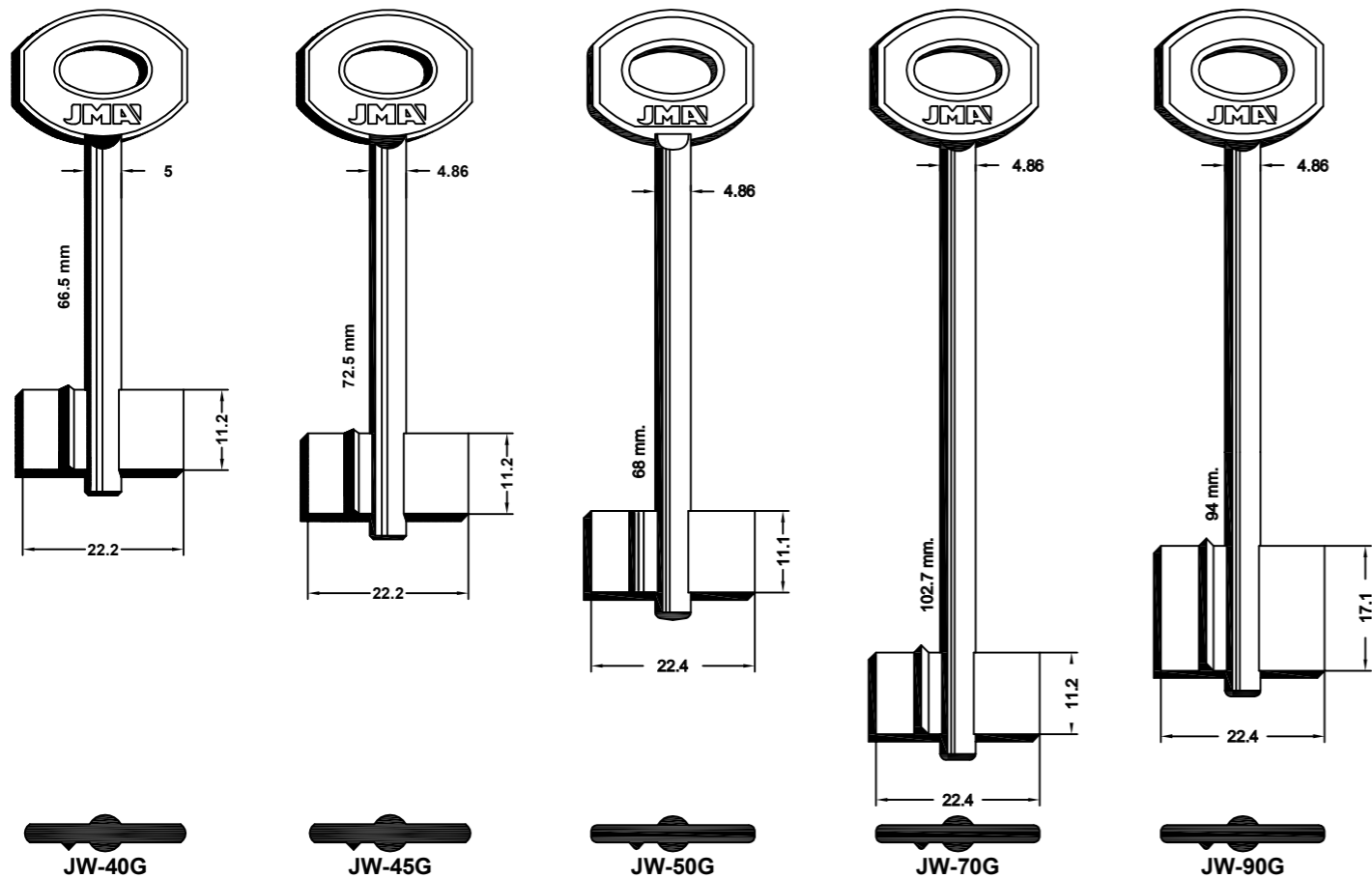

FOR: BURG-WACHTER®

FOR: BURG-WACHTER®

FOR: BURG-WACHTER®

FOR: KERBEROS®

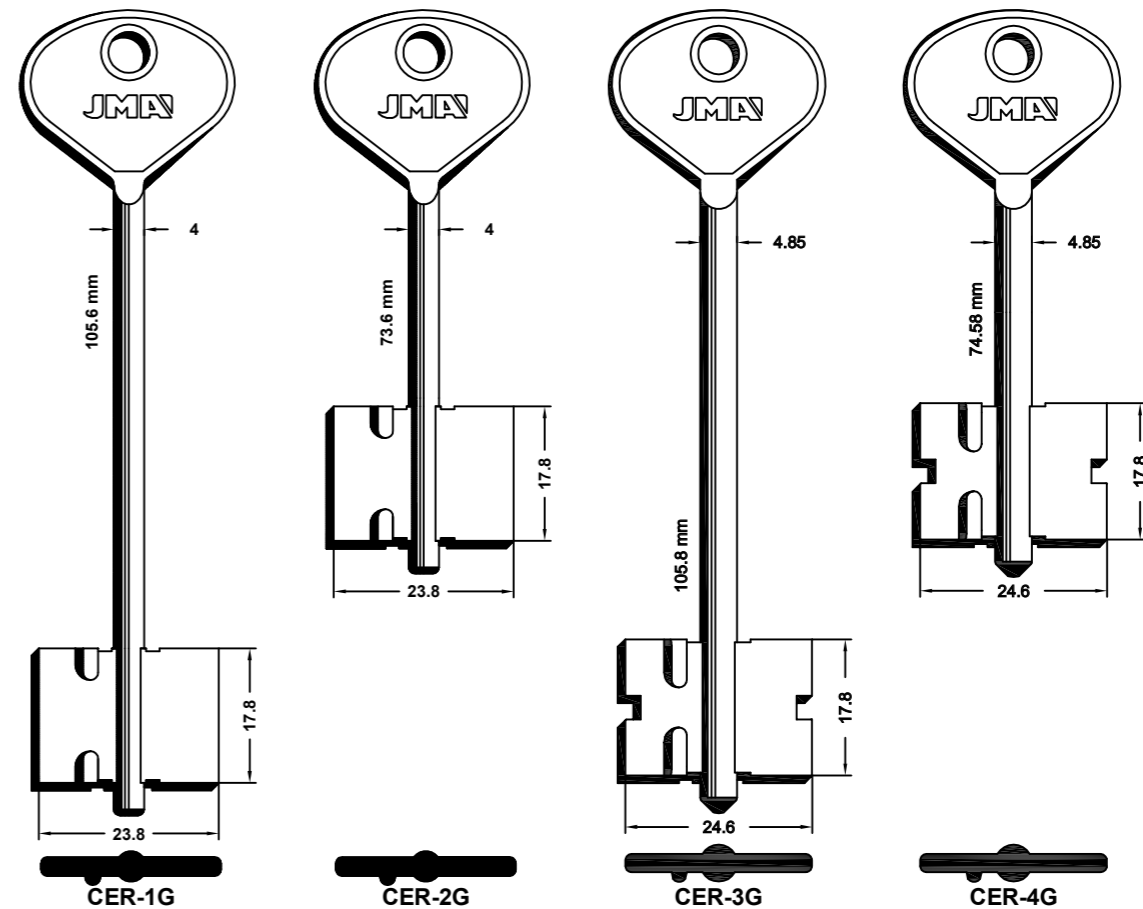

CER-1G

CER-2G

CER-3G

CER-4G

FOR: KREPISH®

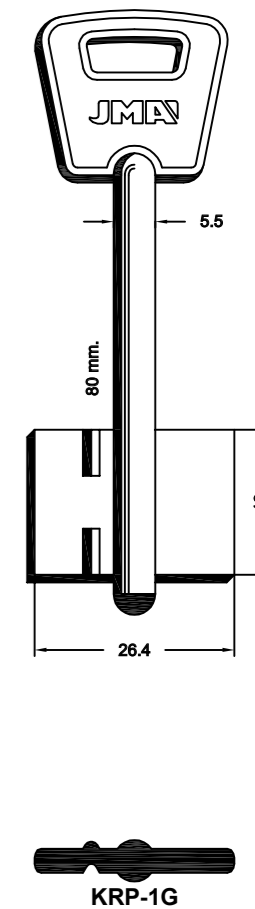

KRP-1G

FOR: KALE®

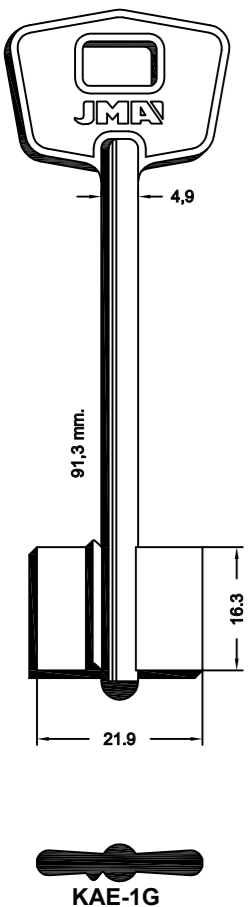

KAE-1G

FOR: KASSEL®

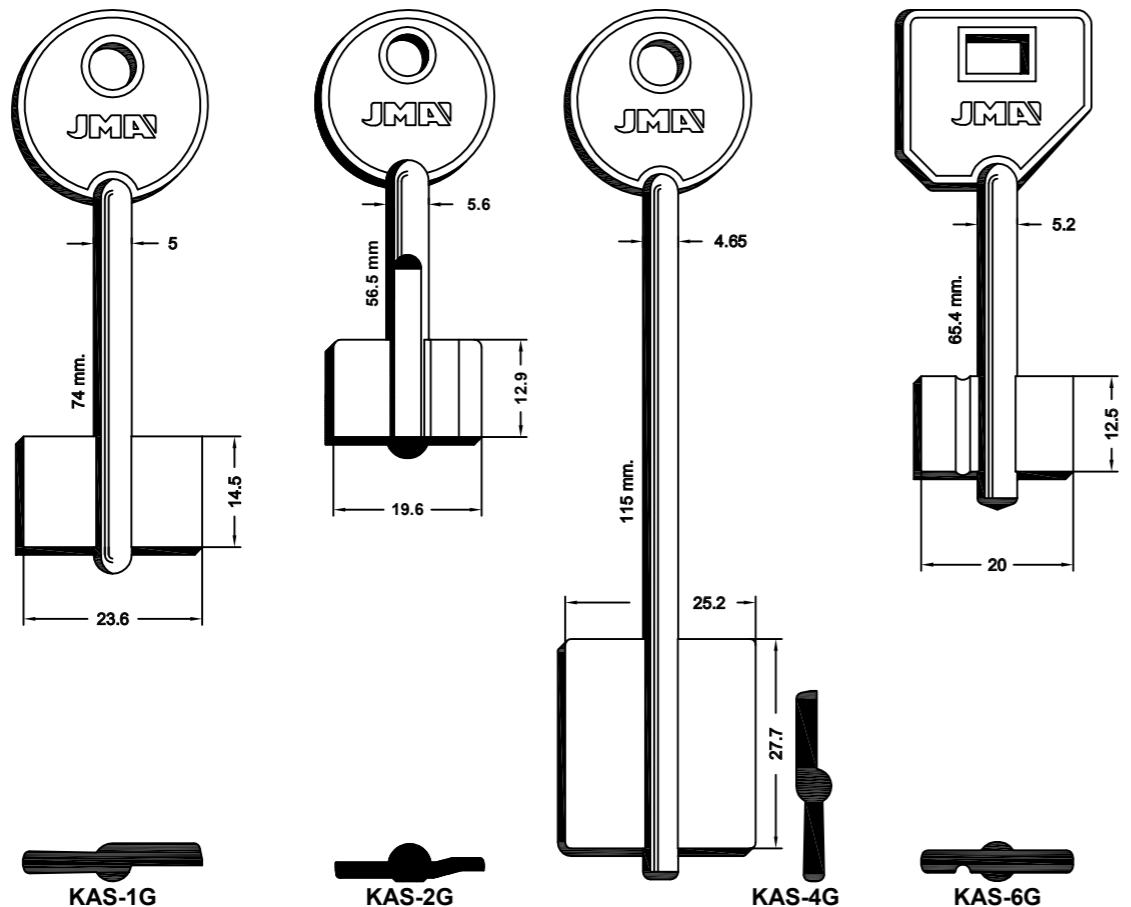

KAS-1G

KAS-2G

KAS-4G

KAS-6G

FOR: KURZEME®

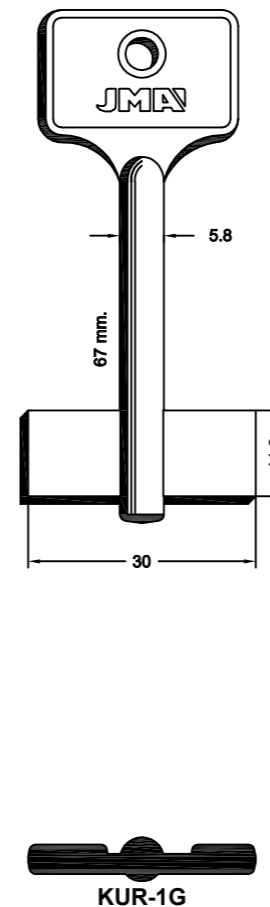

KUR-1G

FOR: LINCE®

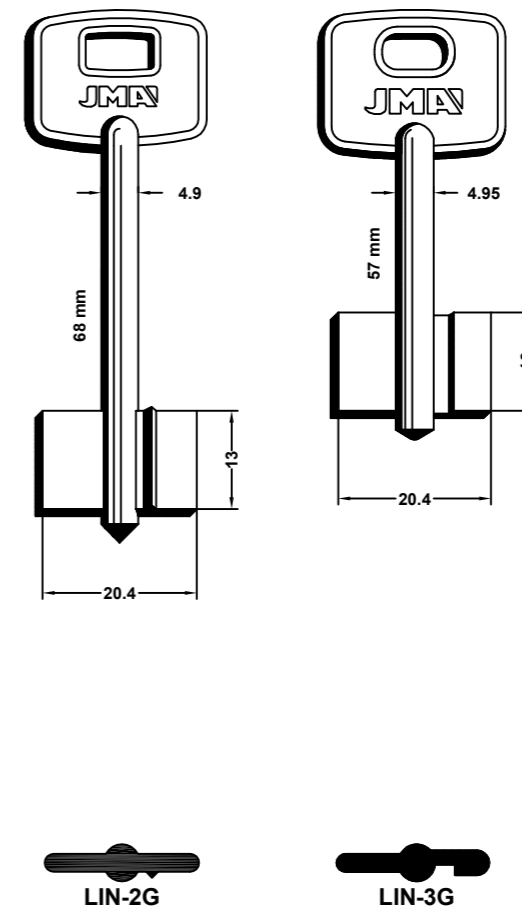

LIN-2G

LIN-3G

FOR: MCM®

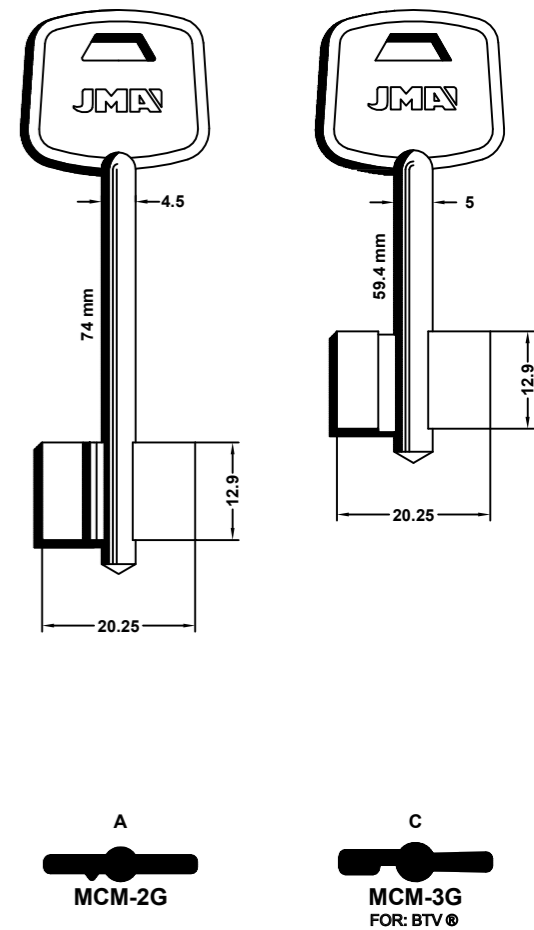

MCM-2G

MCM-3G

FOR: BTV®

Concerning the marks and commercial denominations see legal warning.
 Concerniente a las marcas y denominaciones comerciales ver aviso legal.
 Marka eta izendapen komertzialiei dagokienez, ikus lege-oharra.
 Concernant les marques et dénominations commerciales voir la note dans l'index.

FOR: MCM®

FOR: METAL®

FOR: MOIA®

MCM-5G
FOR: BTV®

MTL-1G

MTL-2G

MOI-1G

MOI-2G

FOR: MOTTURA®

MT-2TG

MT-3G

MT-3P1G

MT-3PG

MT-4G

FOR: MOIA®

FOR: MOTTURA®

MOI-3G

MOI-4G

MOI-5G

FOR: O.M.R.®

O.M.R.

MT-1G

MT-2G

FOR: MOTTURA®

MT-5G

MT-5P1G

MT-6G

MT-6P1G

Concerning the marks and commercial denominations see legal warning.
 Concerniente a las marcas y denominaciones comerciales ver aviso legal.
 Marka eta izendapen komertzialiei dagokienez, ikus lege-oharra.
 Concernant les marques et denominations commerciales voir la note dans l'index.

JMA® Opening the future

JMA® Opening the future

Beziehen auf die Marke und Handelsname sehen sie die Notiz im Index.
 Relativamente às marcas e denominações comerciais, ver aviso legal.
 Jeśli chodzi o znaki i nazwy handlowe, patrz Informacje prawne.

FOR: MOTTURA®

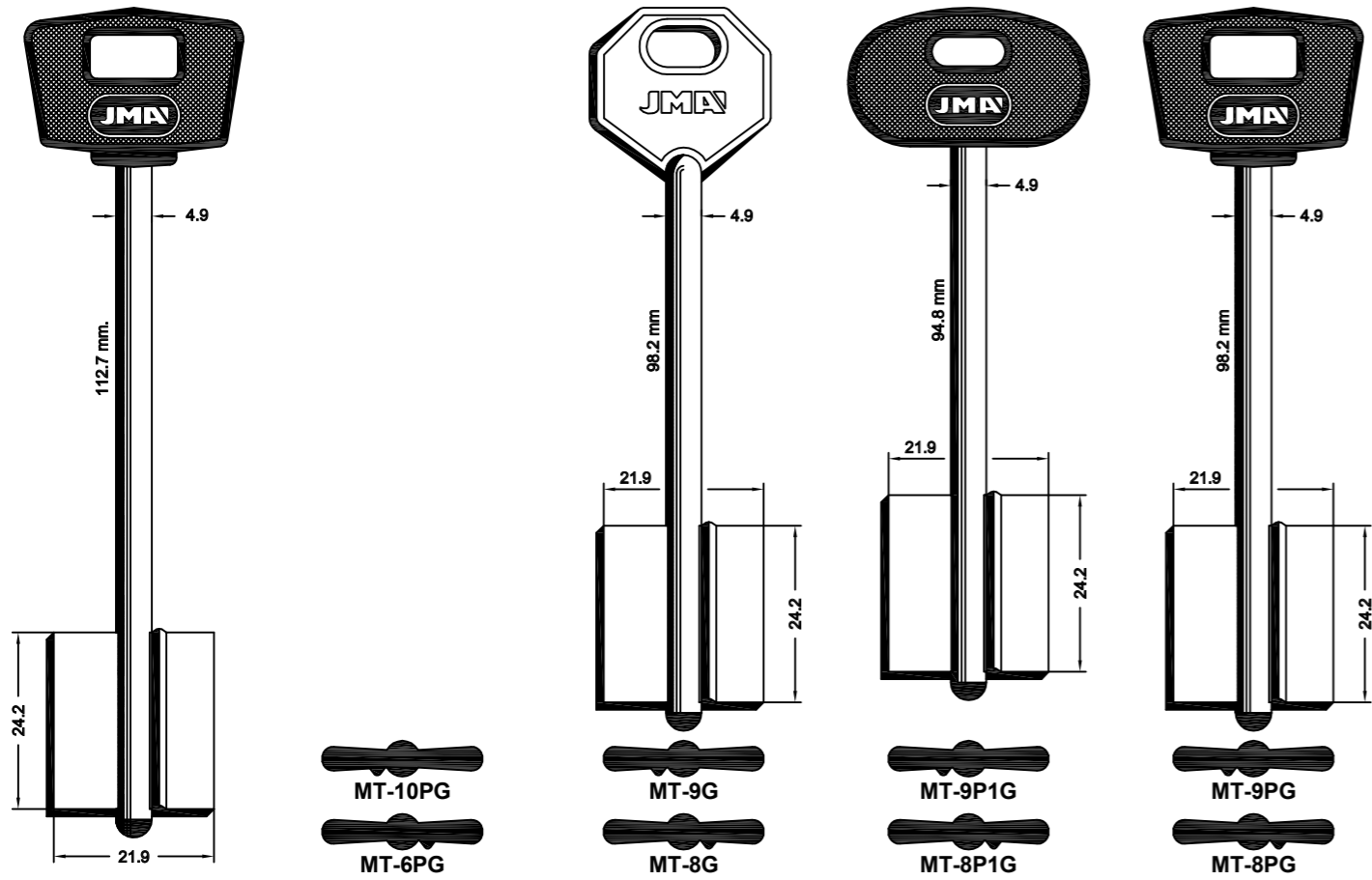

FOR: MOTTURA®

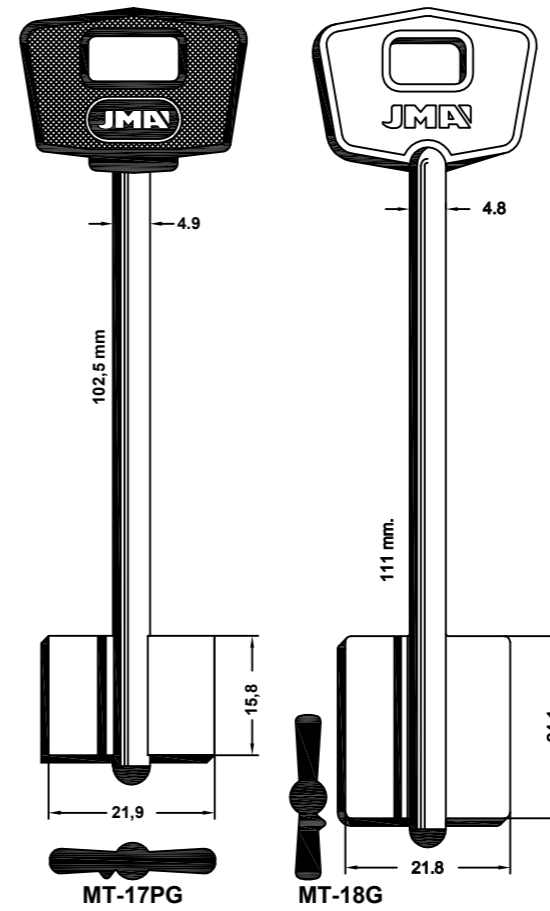

FOR: OMEC®

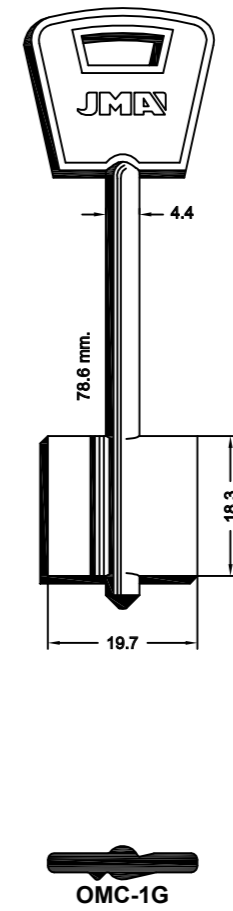

FOR: ORENGO®

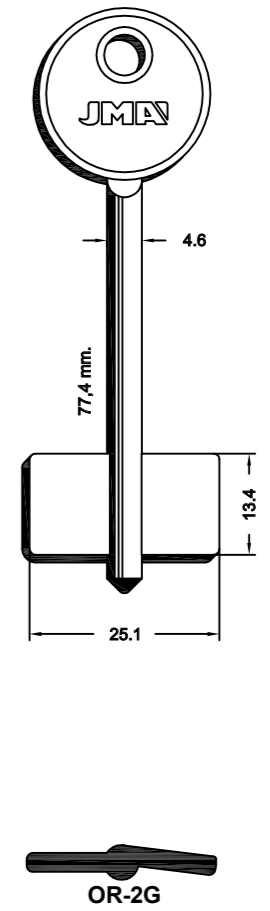

FOR: PATRONE®

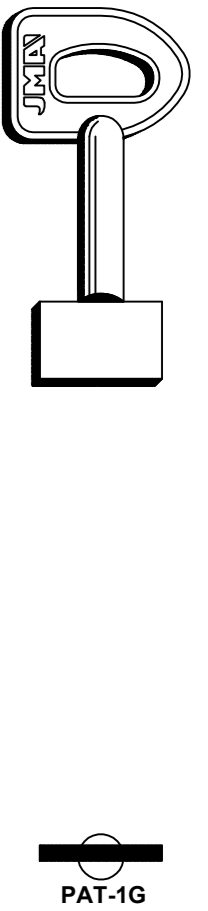

FOR: MOTTURA®

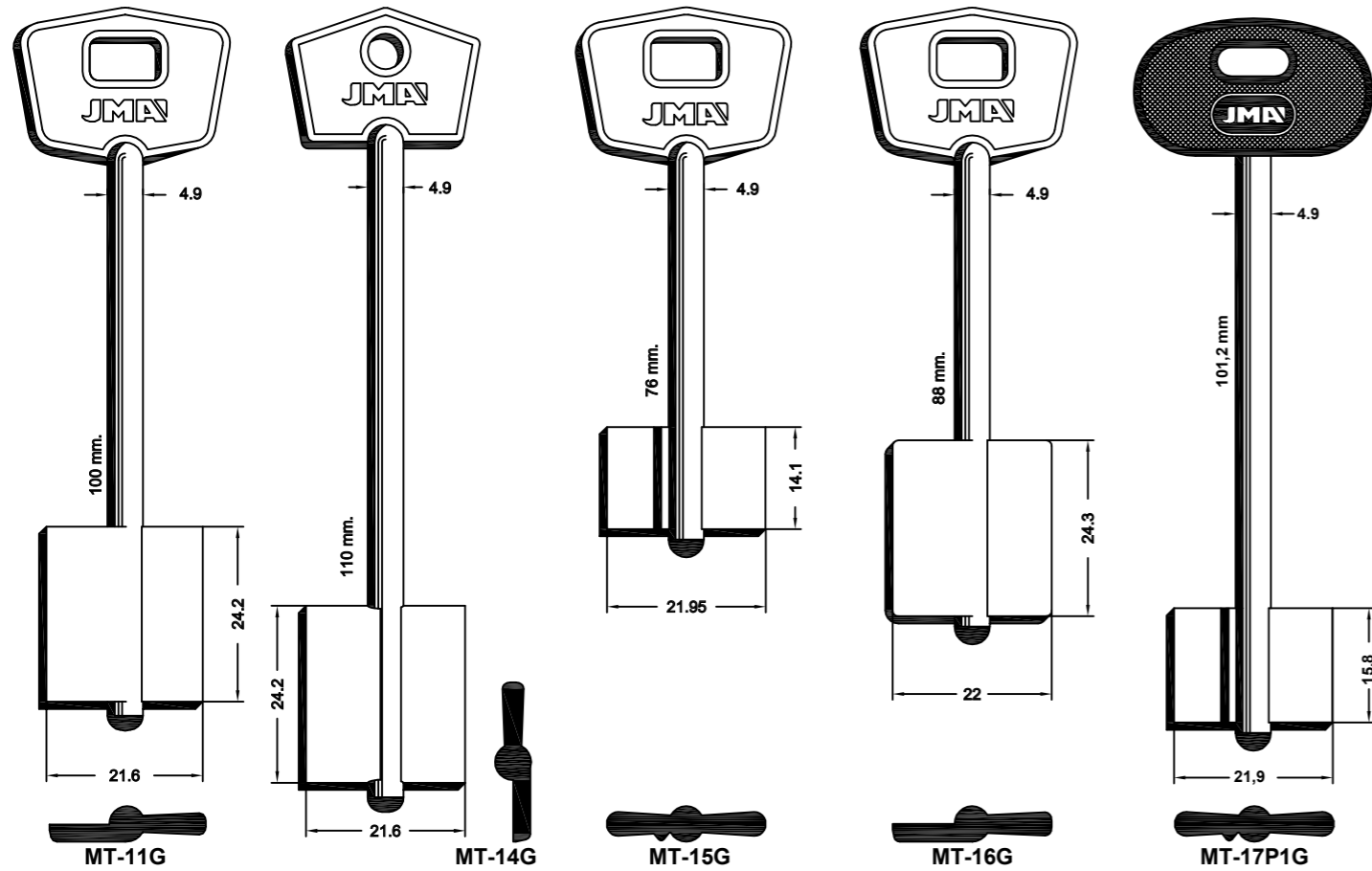

FOR: POTENT®

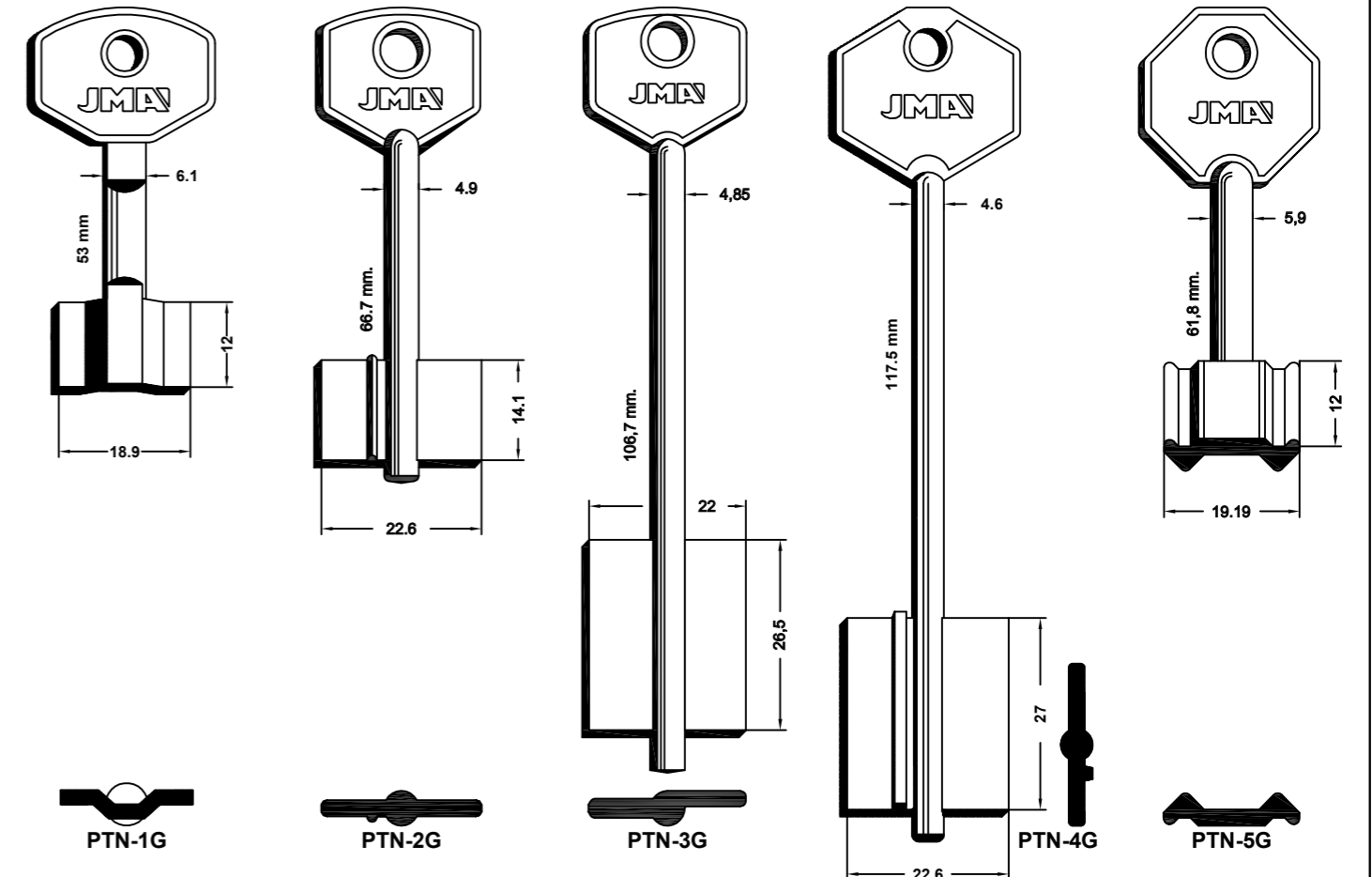

Concerning the marks and commercial denominations see legal warning.
 Concerniente a las marcas y denominaciones comerciales ver aviso legal.
 Marka eta izendapen komertzialiei dagokienez, ikus lege-oharra.
 Concernant les marques et denominations commerciales voir la note dans l'index.

FOR: POTENT®

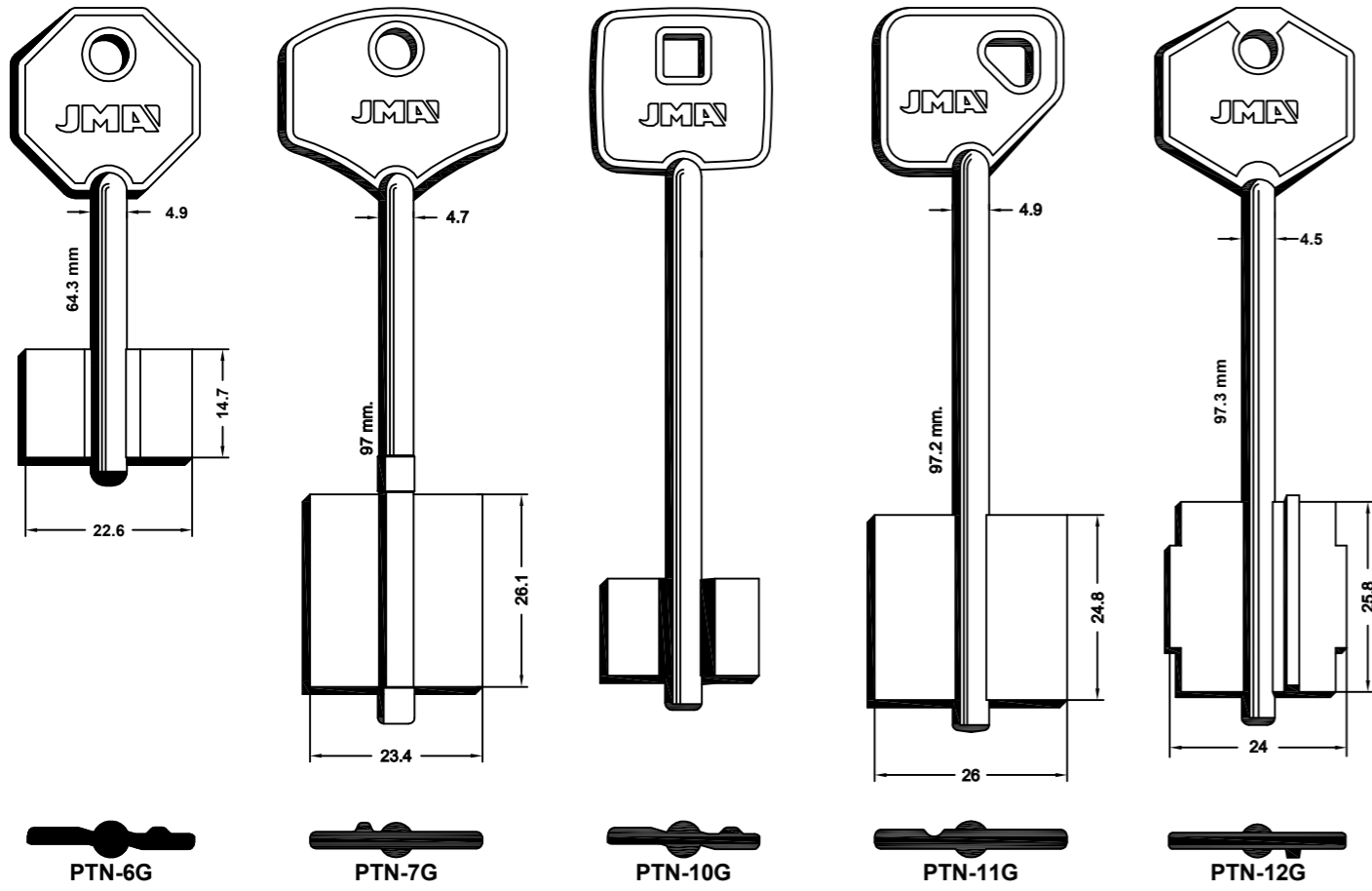

FOR: PREFER®

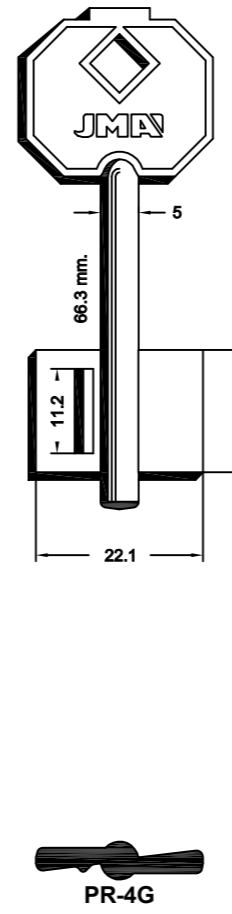

FOR: REVI®

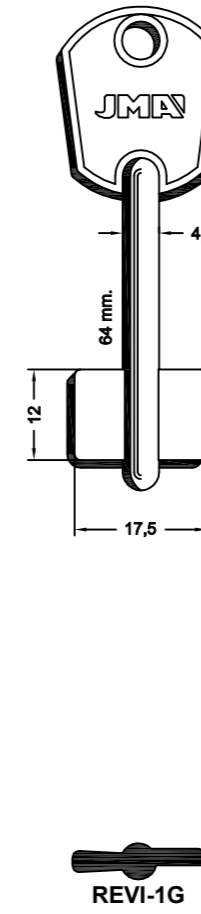

FOR: RIGAL®

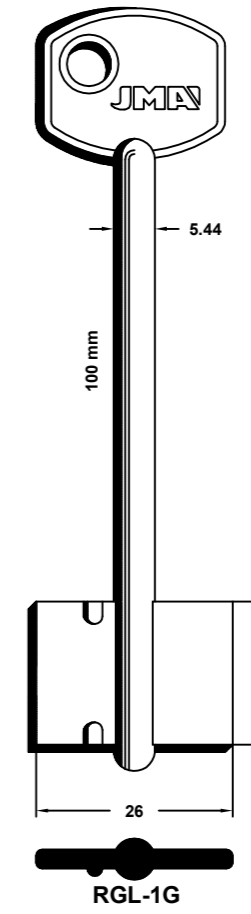

FOR: RUBEN®

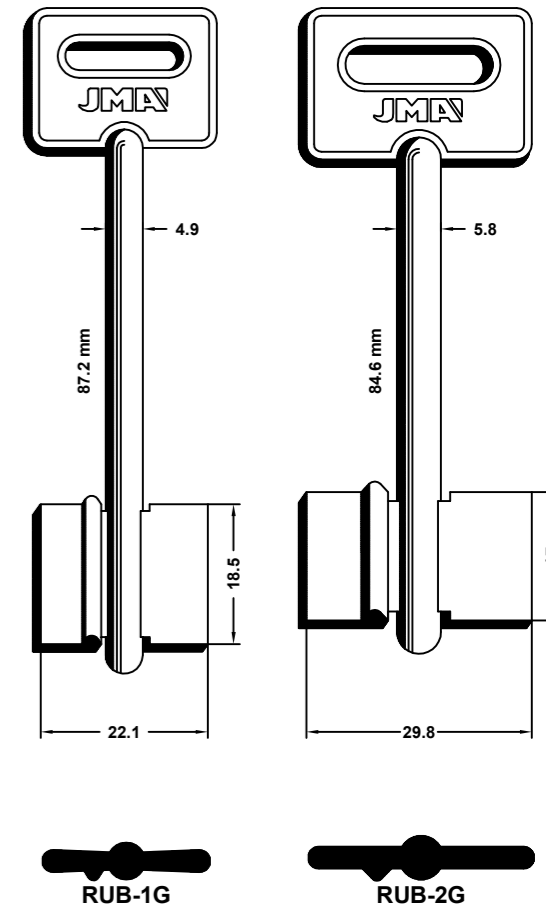

FOR: POTENT®

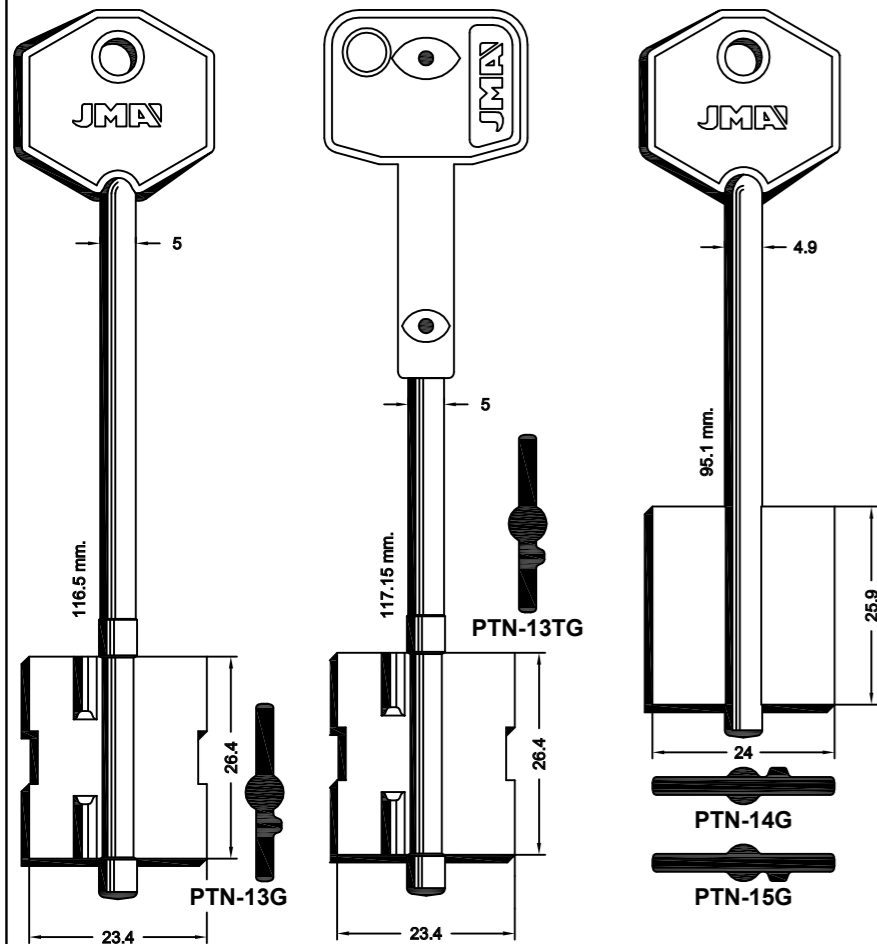

FOR: PREFER®

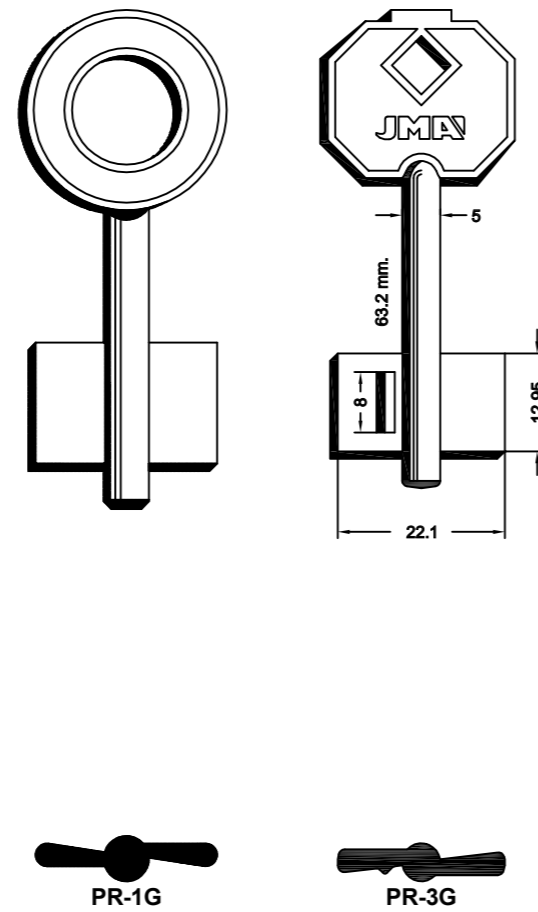

FOR: RUBEN®

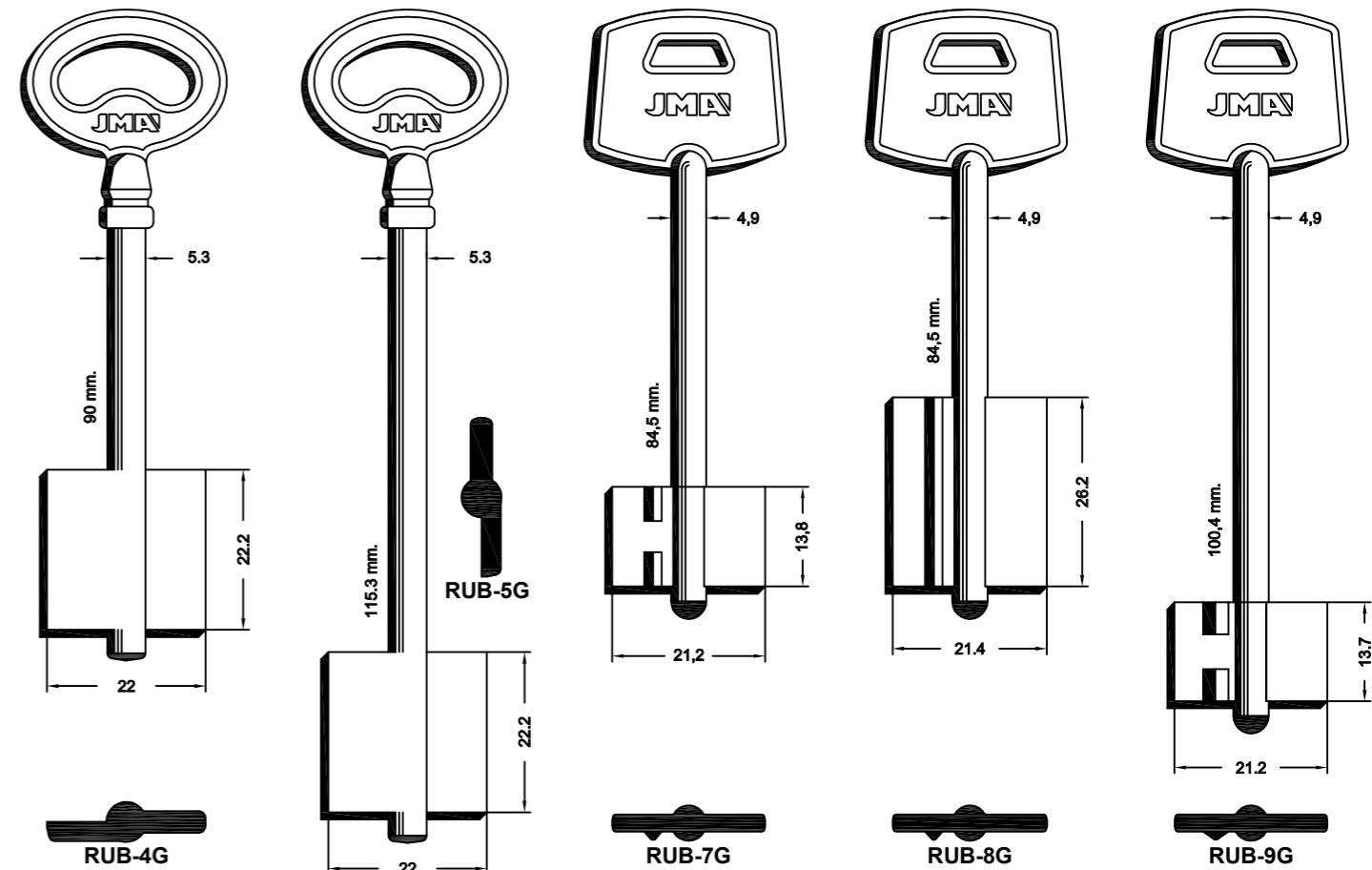

Concerning the marks and commercial denominations see legal warning.
 Concerniente a las marcas y denominaciones comerciales ver aviso legal.
 Marka eta izendapen komertzialiei dagokienez, ikus lege-oharra.
 Concernant les marques et dénominations commerciales voir la note dans l'index.

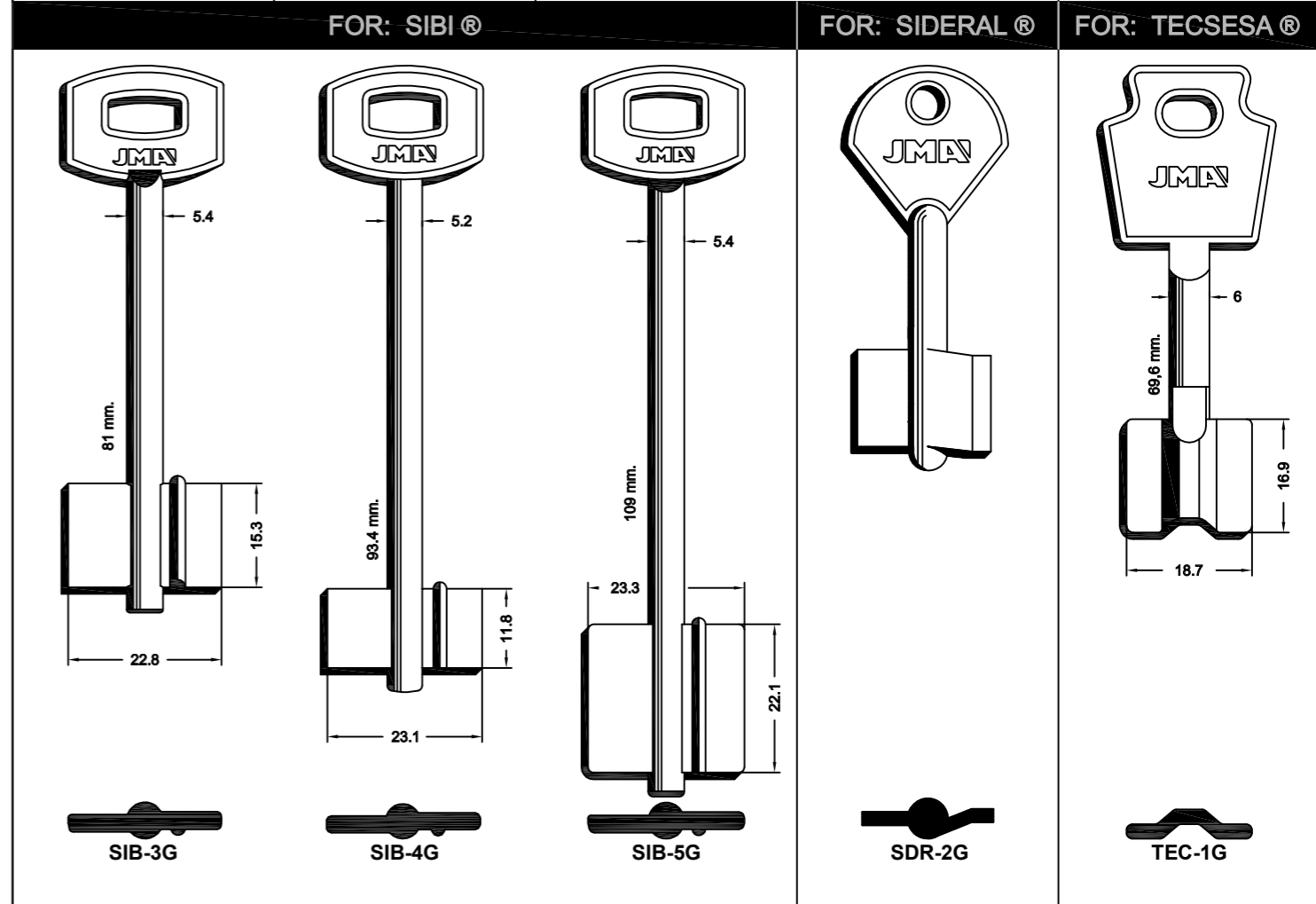
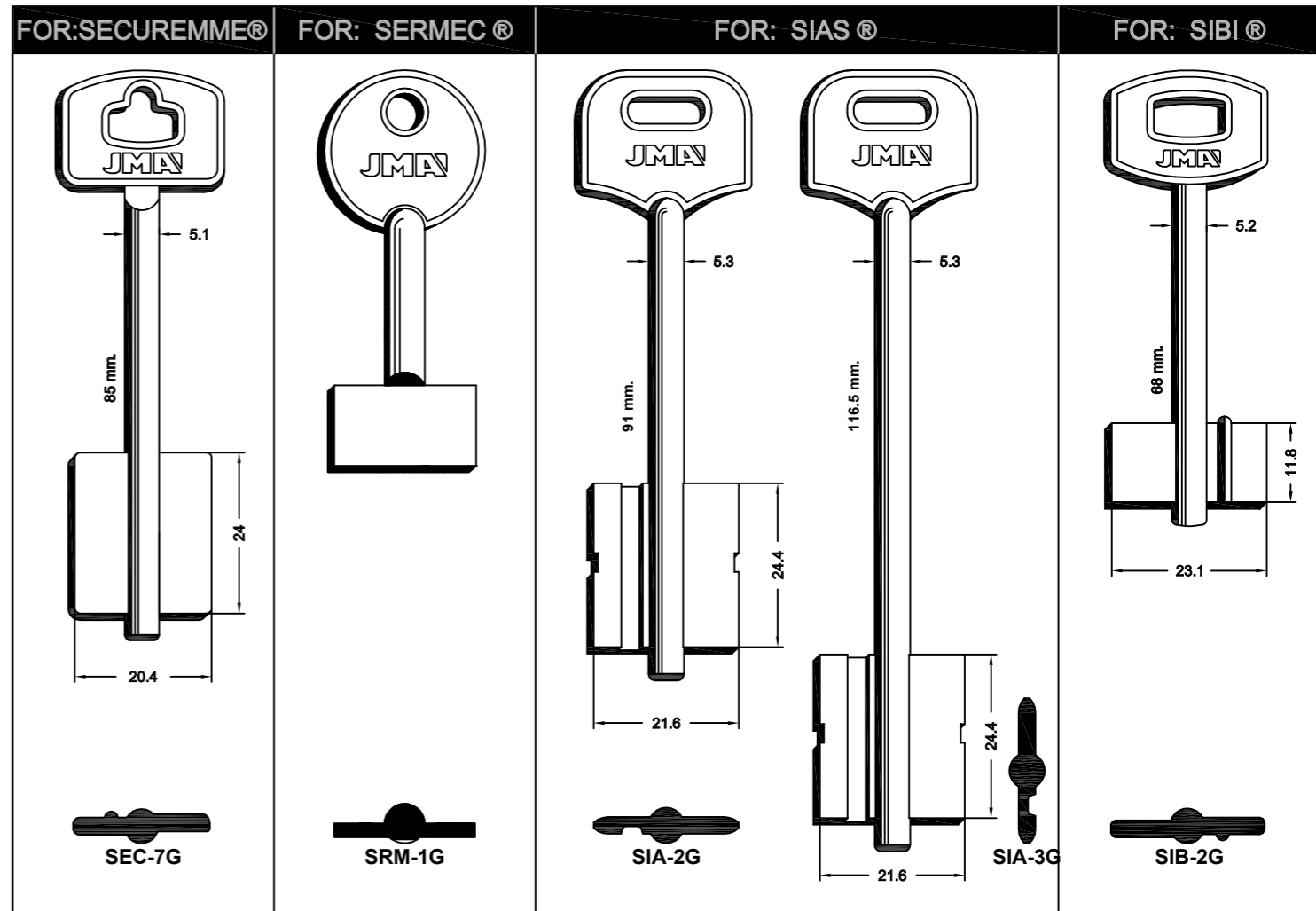
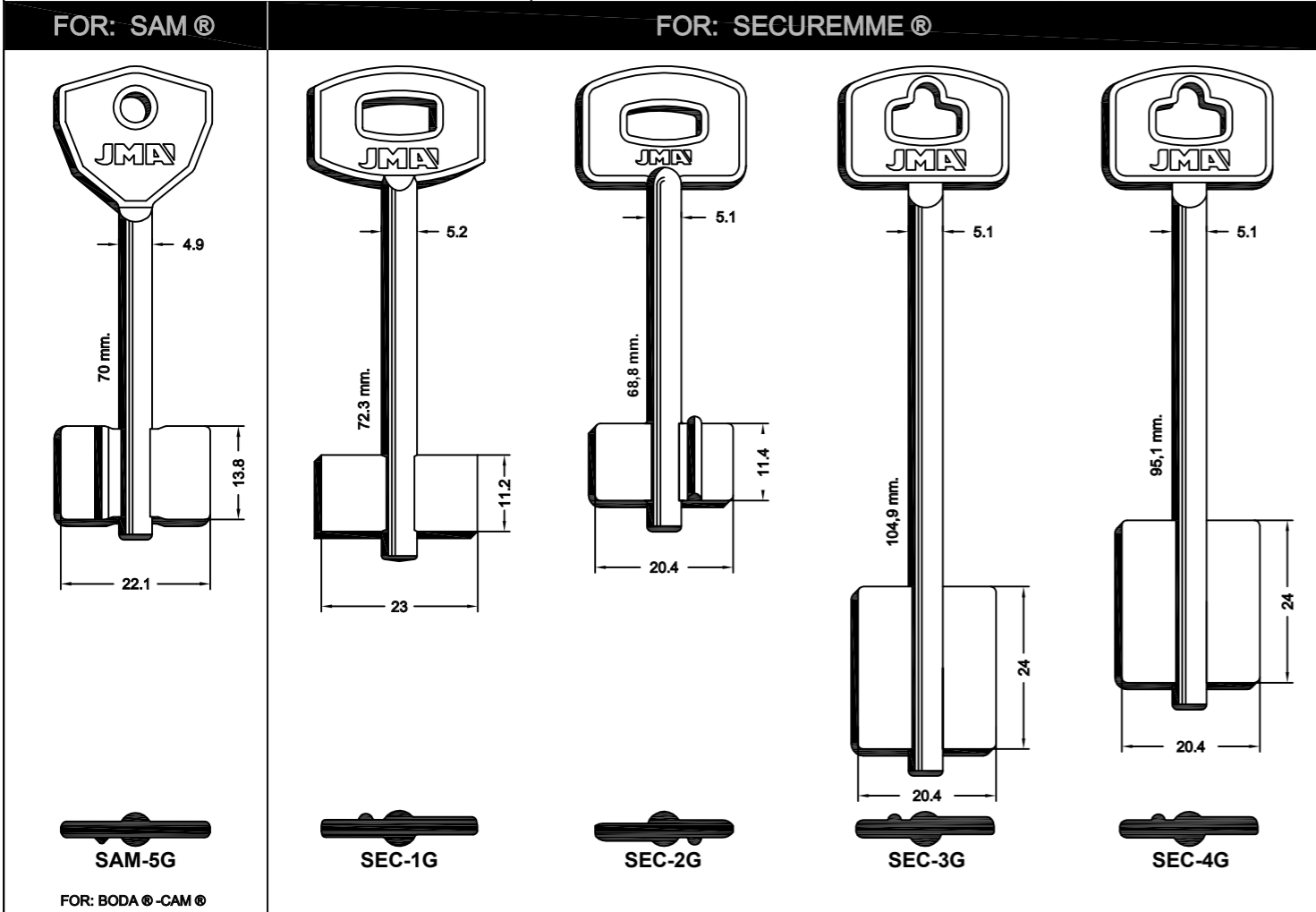
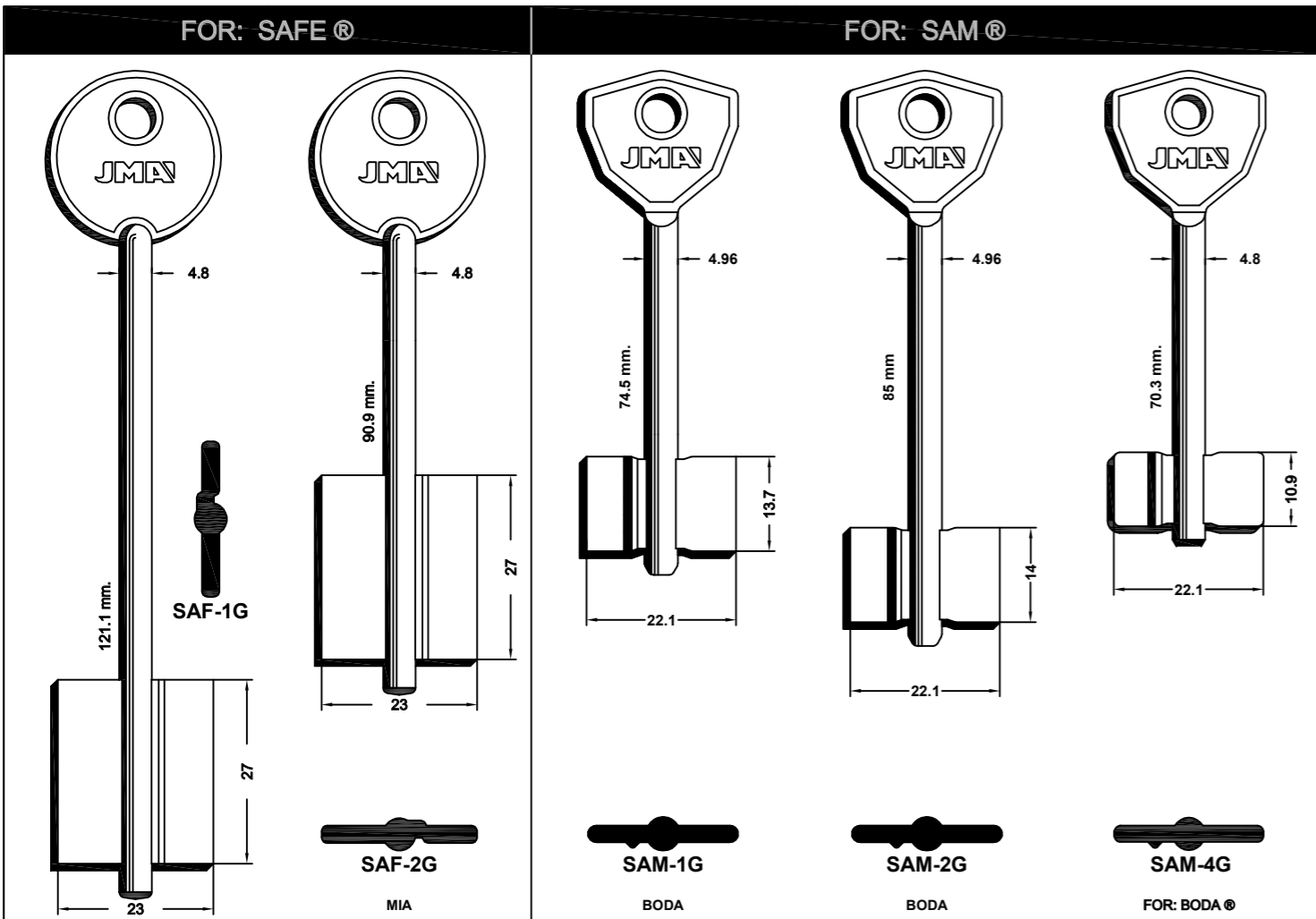

Concerning the marks and commercial denominations see legal warning.
 Concerniente a las marcas y denominaciones comerciales ver aviso legal.
 Marka eta izendapen komertzialiei dagokienez, ikus lege-oharra.
 Concernant les marques et dénominations commerciales voir la note dans l'index.

JMA Opening the future

JMA Opening the future

Beziehen auf die Marke und Handelsname sehen Sie die Notiz im Index.
 Relativamente às marcas e denominações comerciais, ver aviso legal.
 Jeśli chodzi o znaki i nazwy handlowe, patrz Informacje prawne.

FOR: TESIO®	FOR: TITANO®		FOR: TOVER®	FOR: 4 TR®
<p>4.8</p> <p>90.6 mm.</p> <p>25.5</p> <p>22.8</p> <p>TSI-1G</p>	<p>TTN-1G</p>	<p>TTN-2G</p>	<p>6.2</p> <p>59.05 mm</p> <p>11.95</p> <p>15.9</p> <p>TOV-1G</p>	<p>TR-1G</p>

FOR: YALE®	
<p>YA-3G</p>	<p>YA-4G</p>

FOR: TUSHINO®	FOR: WELKA®		FOR: YALE®	
<p>4.9</p> <p>53 mm</p> <p>12</p> <p>18</p> <p>TUS-1G</p>	<p>WE-1G</p>	<p>WE-2G</p>	<p>YA-1G</p>	<p>YA-2G</p>

<p>62.3</p> <p>6.1</p> <p>20.35</p> <p>4.1</p> <p>17.9</p> <p>51G</p>	<p>72</p> <p>6</p> <p>17.9</p> <p>15.9</p> <p>52 GPC</p>	<p>72</p> <p>6.15</p> <p>20.25</p> <p>4.1</p> <p>22.2</p> <p>52G</p>	<p>80.9</p> <p>6.15</p> <p>20.1</p> <p>4.1</p> <p>19.1</p> <p>53G</p>	<p>90</p> <p>6</p> <p>23</p> <p>21</p> <p>54G</p>
---	--	--	---	---

Concerning the marks and commercial denominations see legal warning.
 Concerniente a las marcas y denominaciones comerciales ver aviso legal.
 Marka eta izendapen komertzialiei dagokienez, ikus lege-oharra.
 Concernant les marques et dénominations commerciales voir la note dans l'index.

JMA® Opening the future

JMA® Opening the future

Beziehen auf die marke und handelsname sehen sie die notiz im index.
 Relativamente às marcas e denominações comerciais, ver aviso legal.
 Jeśli chodzi o znaki i nazwy handlowe, patrz Informacje prawne.

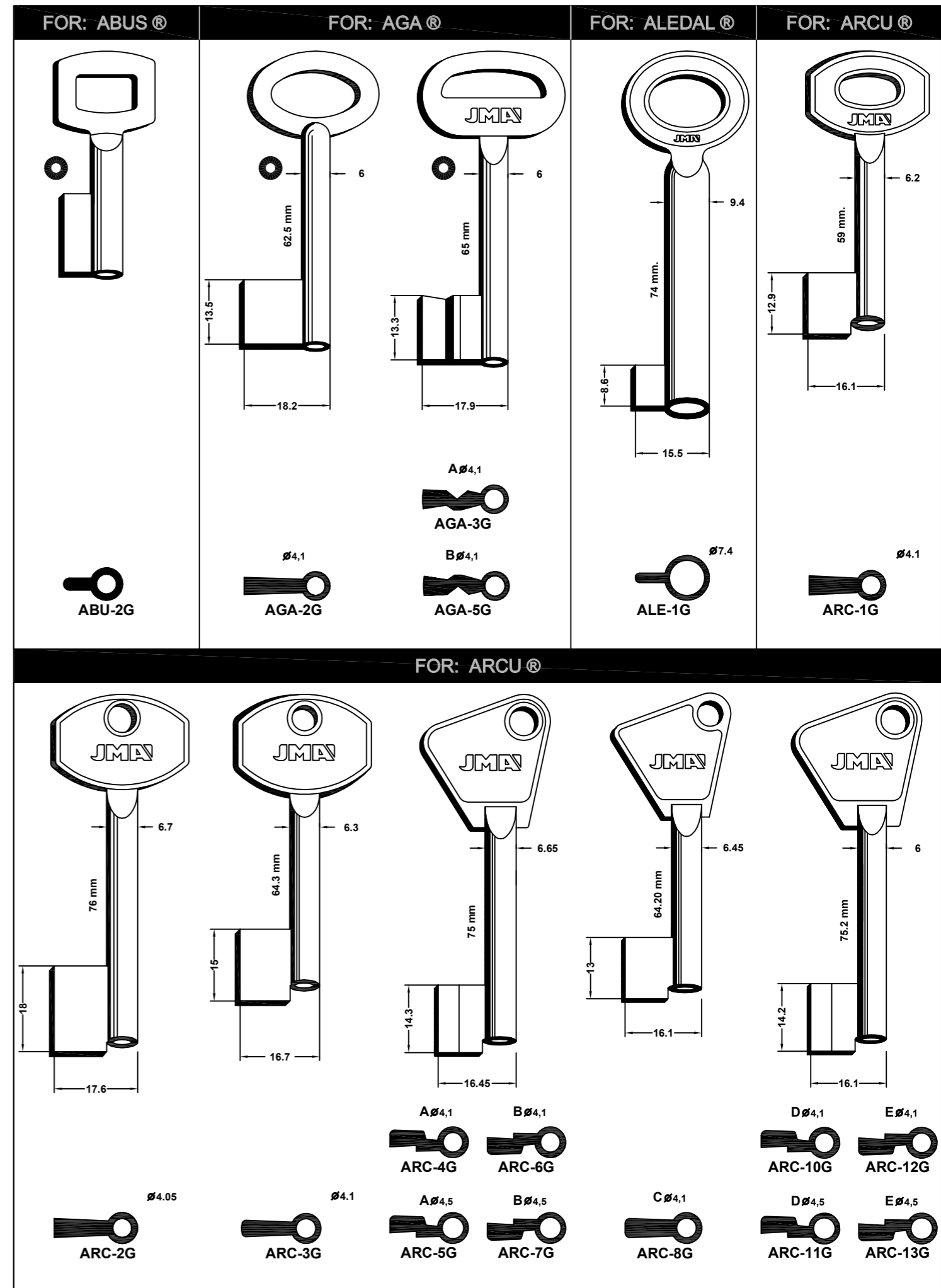
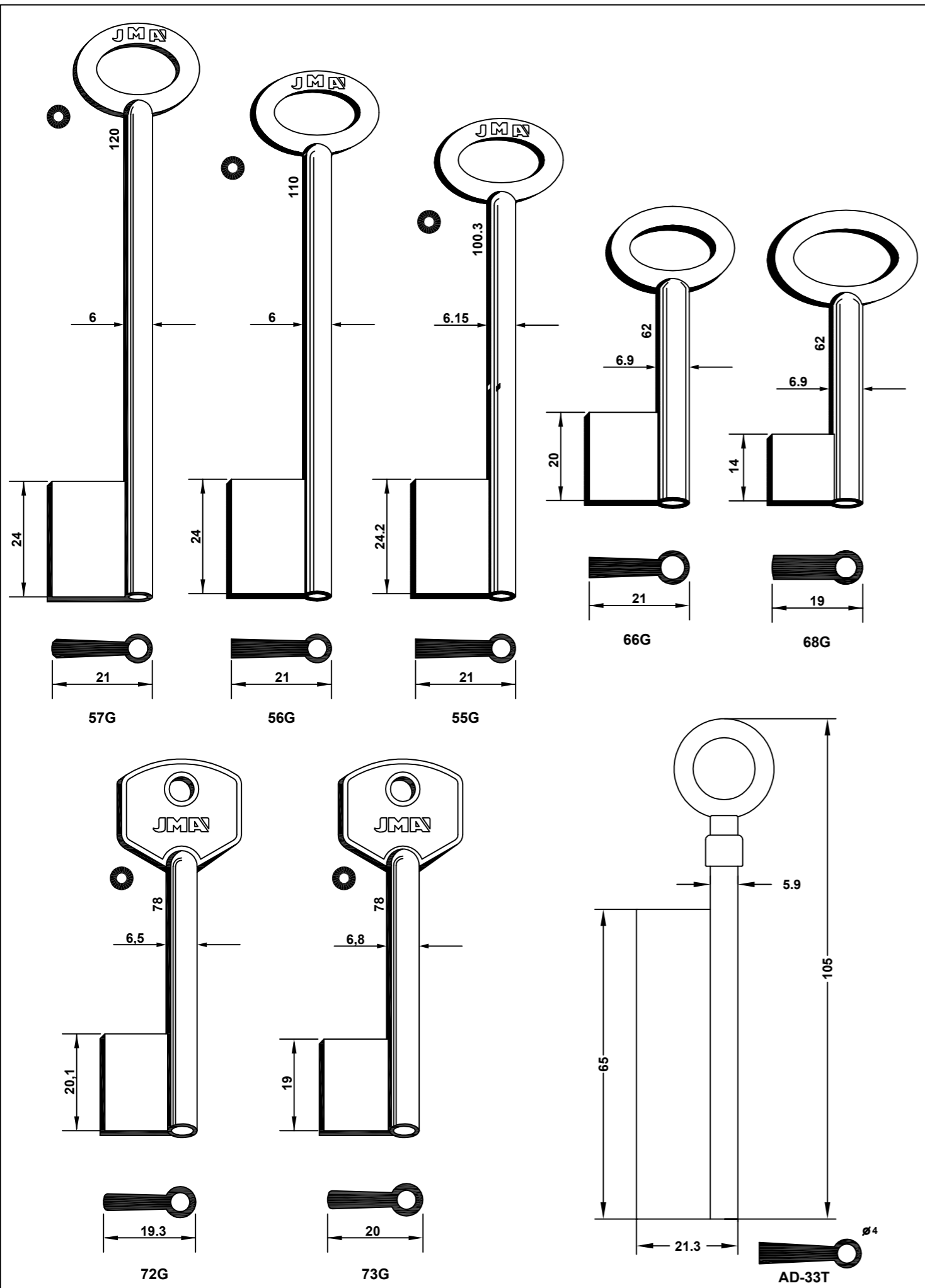

Concerning the marks and commercial denominations see legal warning.
 Concerniente a las marcas y denominaciones comerciales ver aviso legal.
 Marka eta izendapen komertzialiei dagokienez, ikus lege-oharra.
 Concernant les marques et dénominations commerciales voir la note dans l'index.

JMA Opening the future

JMA Opening the future

Beziehen auf die Marke und Handelsname sehen Sie die Notiz im Index.
 Relativamente às marcas e denominações comerciais, ver aviso legal.
 Jeśli chodzi o znaki i nazwy handlowe, patrz Informacje prawne.

FOR: ARCU®

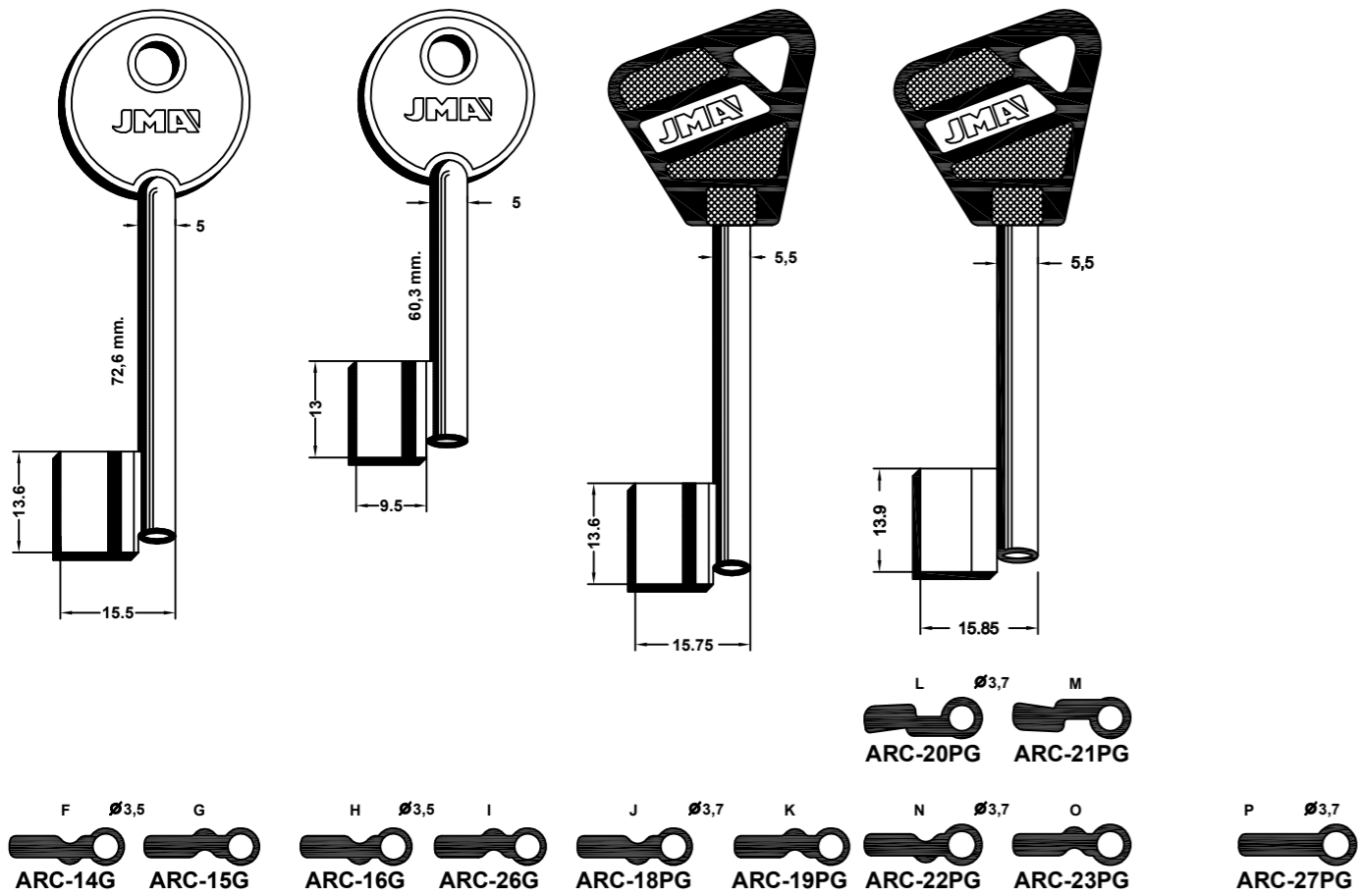

FOR: LAR®

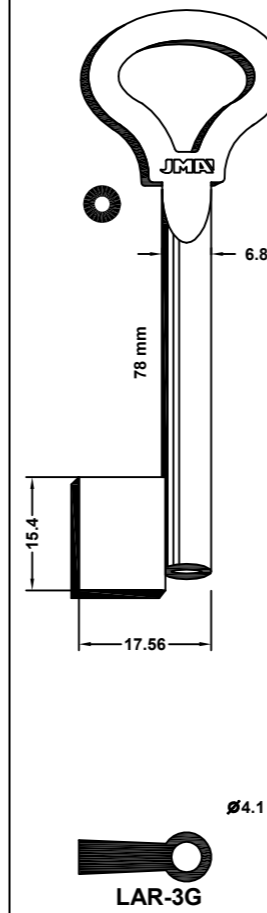

FOR: ORENGO®

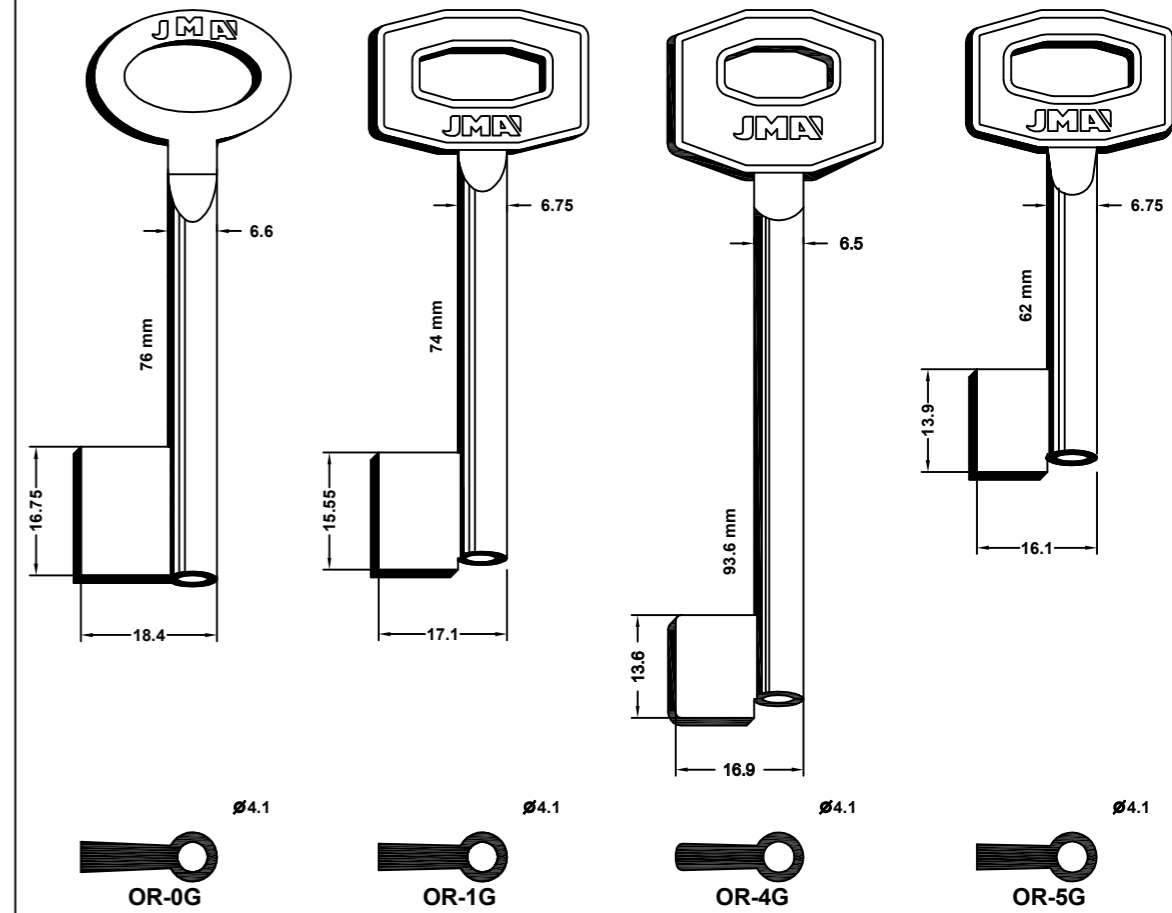

FOR: ARCU®

FOR: ASSA®

FOR: AYPE®

FOR: CERUTTI®

FOR: LAR®

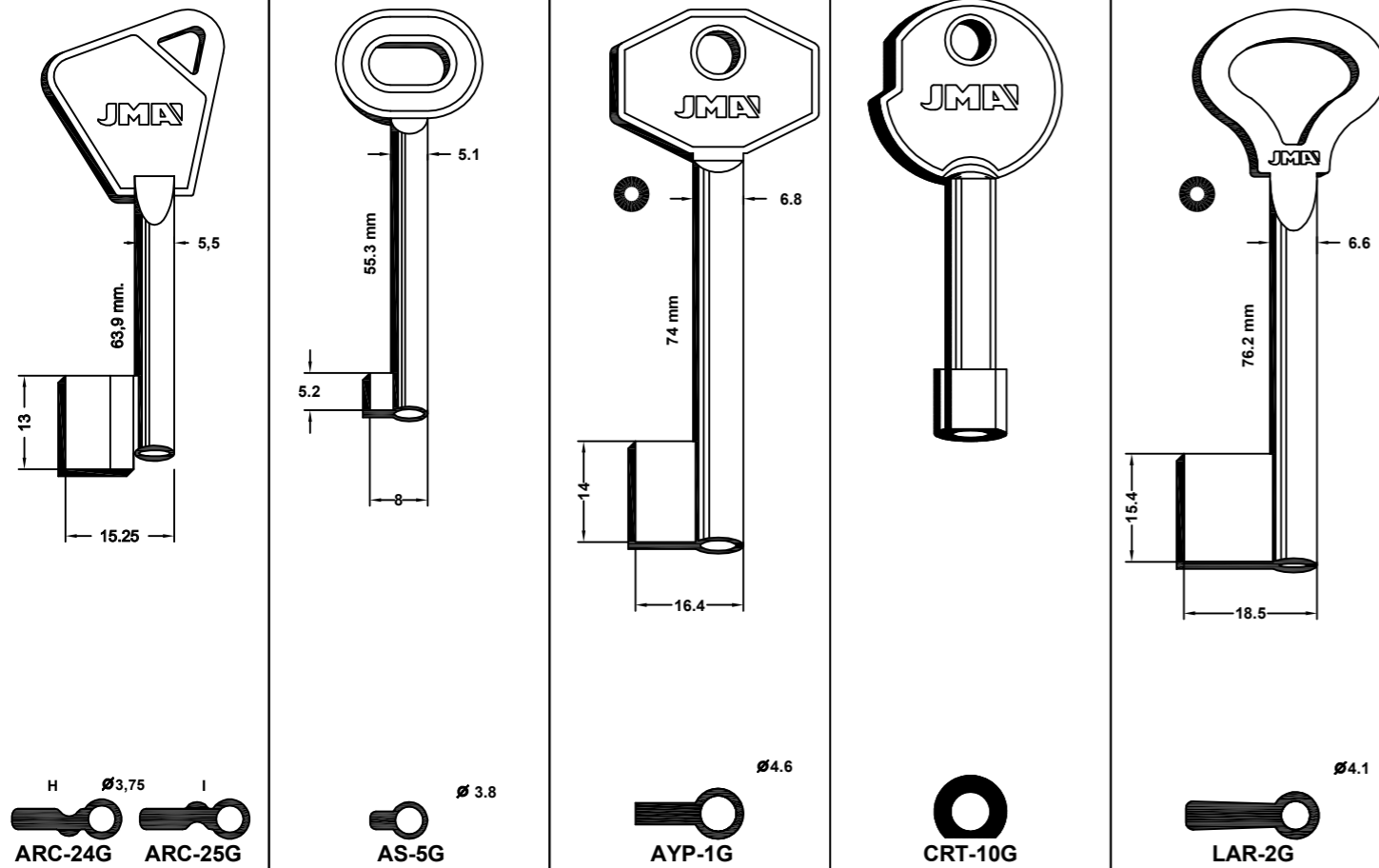

FOR: RUBEN®

FOR: RUE®

FOR: VACHETTE®

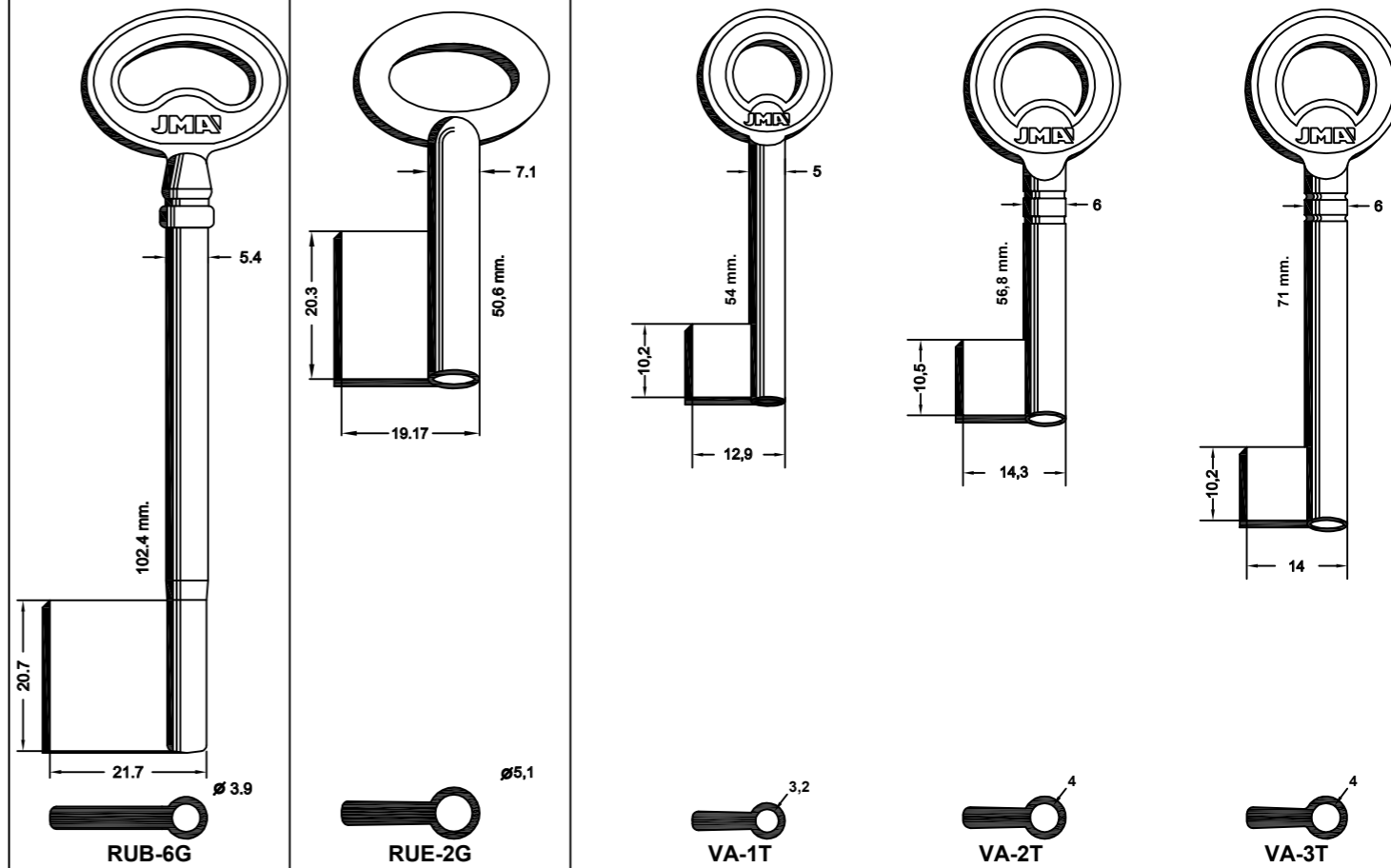

Concerning the marks and commercial denominations see legal warning.
 Concerniente a las marcas y denominaciones comerciales ver aviso legal.
 Marka eta izendapen komertzialiei dagokienez, ikus lege-oharra.
 Concernant les marques et dénominations commerciales voir la note dans l'index.



FOR: VACHETTE®

FOR: VILLFER®

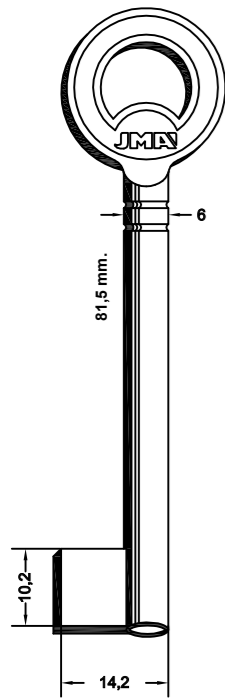

VA-5T

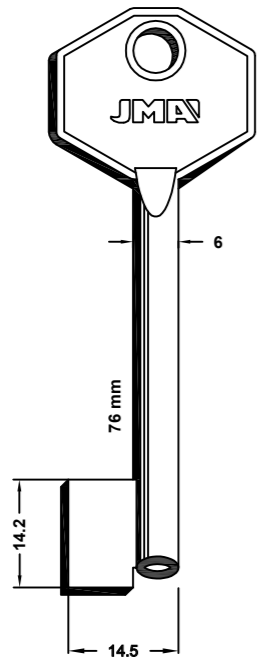

VILL-1G

FOR: AGA®

FOR: ARES®

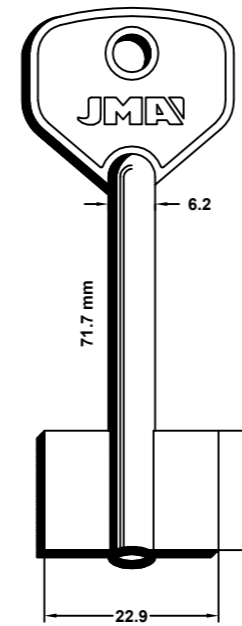

AGA-7G

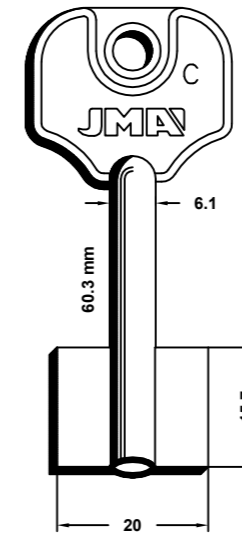

AGA-8G
FOR: ARFE®

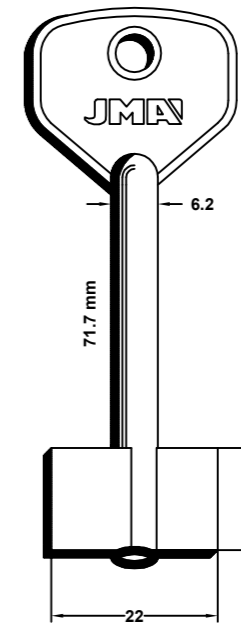

AGA-9G

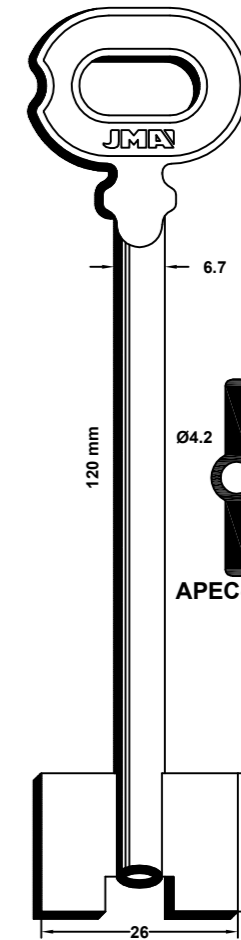

APEC-1G

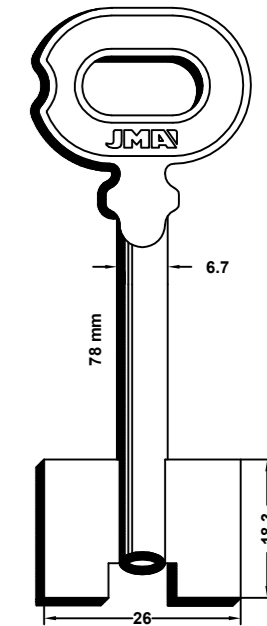

APEC-2G

FOR: AGA®

FOR: BURG®

FOR: CRONOS®

FOR: DUPLEX®

FOR: DVERNIAC®

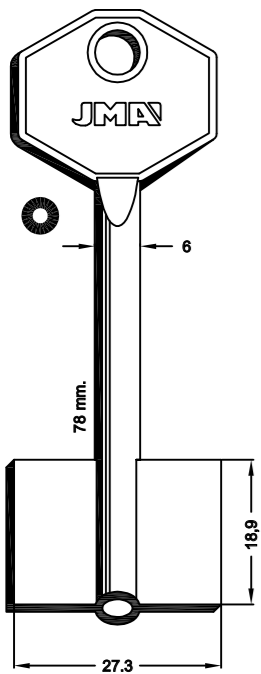

101G

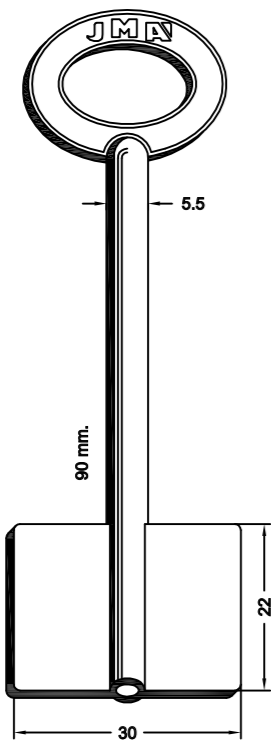

AD-46

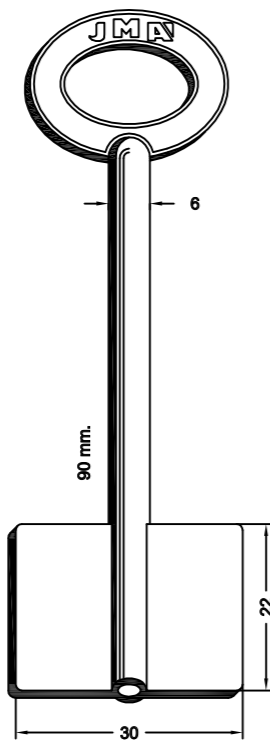

AD-47

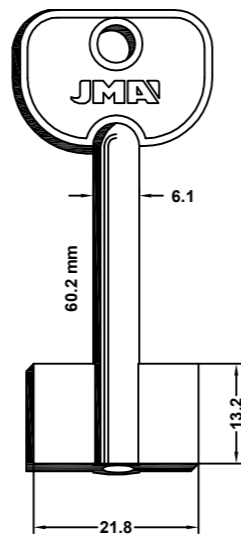

AGA-4G
FOR: FECOR®

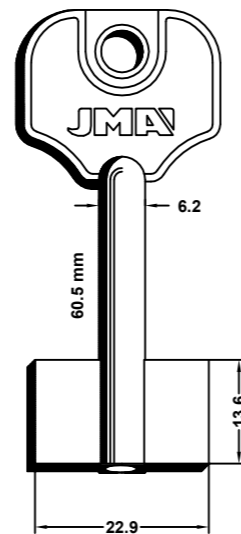

AGA-6G
FOR: ARFE®

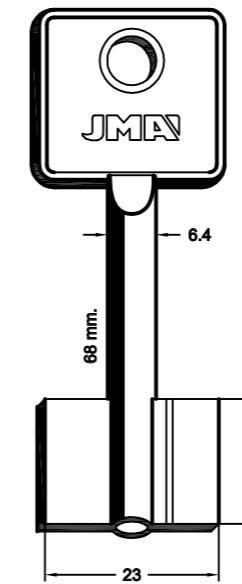

BUR-1G

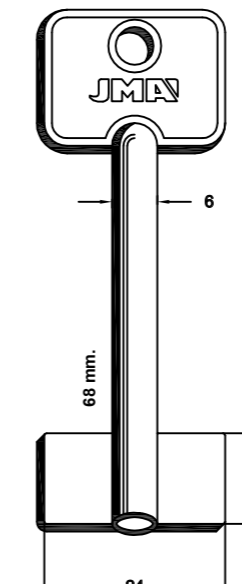

CRO-1G

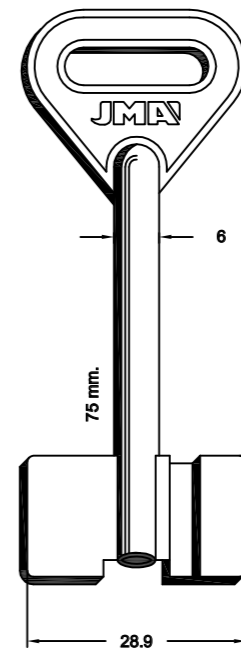

DUP-1G

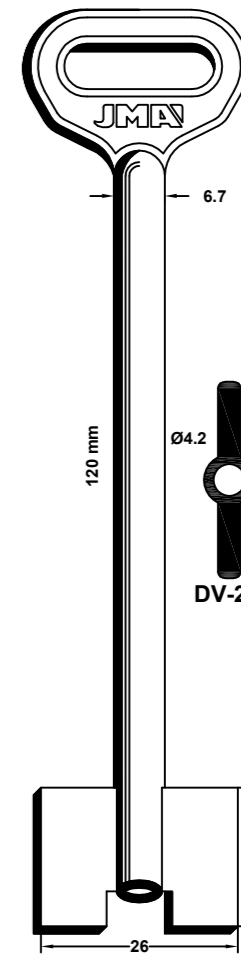

DV-2G

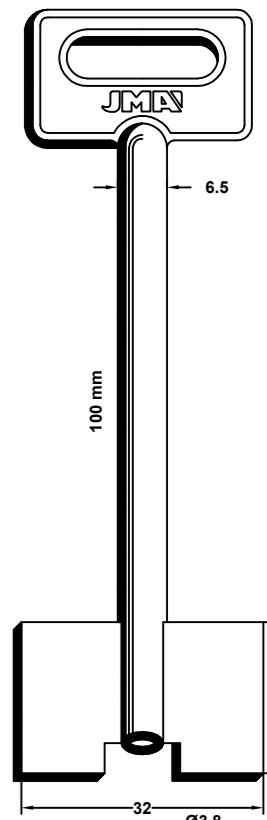

DV-4G

Concerning the marks and commercial denominations see legal warning.
 Concerniente a las marcas y denominaciones comerciales ver aviso legal.
 Marka eta izendapen komertzialiei dagokienez, ikus lege-oharra.
 Concernant les marques et dénominations commerciales voir la note dans l'index.

FOR: DVERNIAK®				FOR: EREVAN®
<p>DV-10G/A</p>	<p>DV-11G</p>	<p>DV-13G/A</p>	<p>DV-17G</p>	<p>ERV-3G/A</p>

FOR: SERRALLER®	FOR: SIBI®
<p>SER-1G FOR: ARFE®</p>	<p>SIB-1G FOR: ARFE®</p>

FOR: MACOR®	FOR: MAXIM®		FOR: PREFER®	FOR: RUBEN®
<p>MAC-1G</p>	<p>MAX-1G</p>	<p>MAX-2G</p>	<p>PR-2G</p>	<p>RUB-3G</p>

Concerning the marks and commercial denominations see legal warning.
 Concerniente a las marcas y denominaciones comerciales ver aviso legal.
 Marka eta izendapen komertzialiei dagokienez, ikus lege-oharra.
 Concernant les marques et dénominations commerciales voir la note dans l'index.

JMA® Opening the future

JMA® Opening the future

Beziehen auf die marke und handelsname sehen sie die notiz im index.
 Relativamente às marcas e denominações comerciais, ver aviso legal.
 Jeśli chodzi o znaki i nazwy handlowe, patrz Informacje prawne.



ZAMAK

MORTICE KEYS

Llaves de Gorja
Gorja motako giltzak

Clés à gorge
Tresor-Schlüssel

Chaves de gorja
Klucze zasuwowe

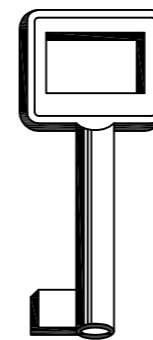
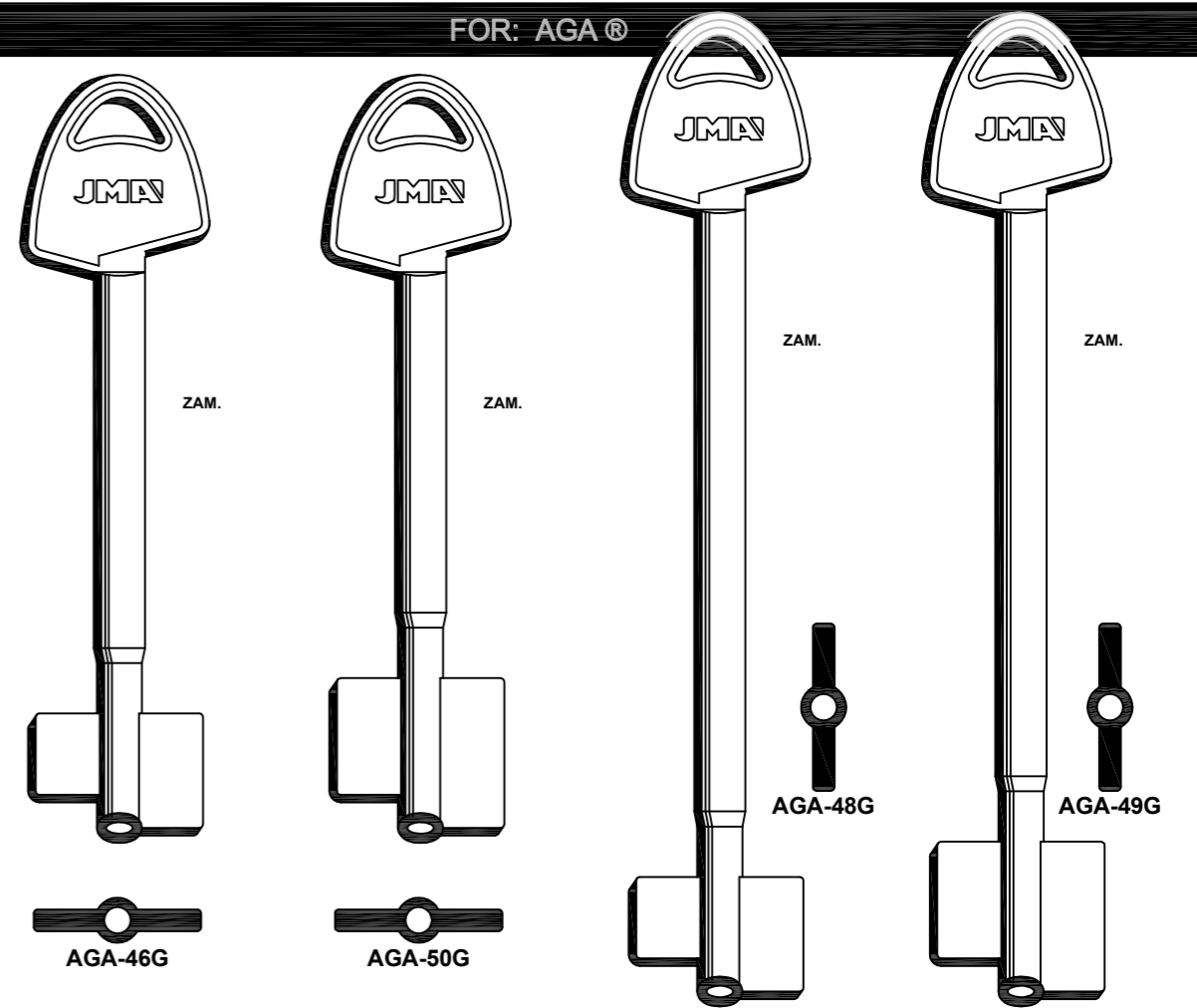
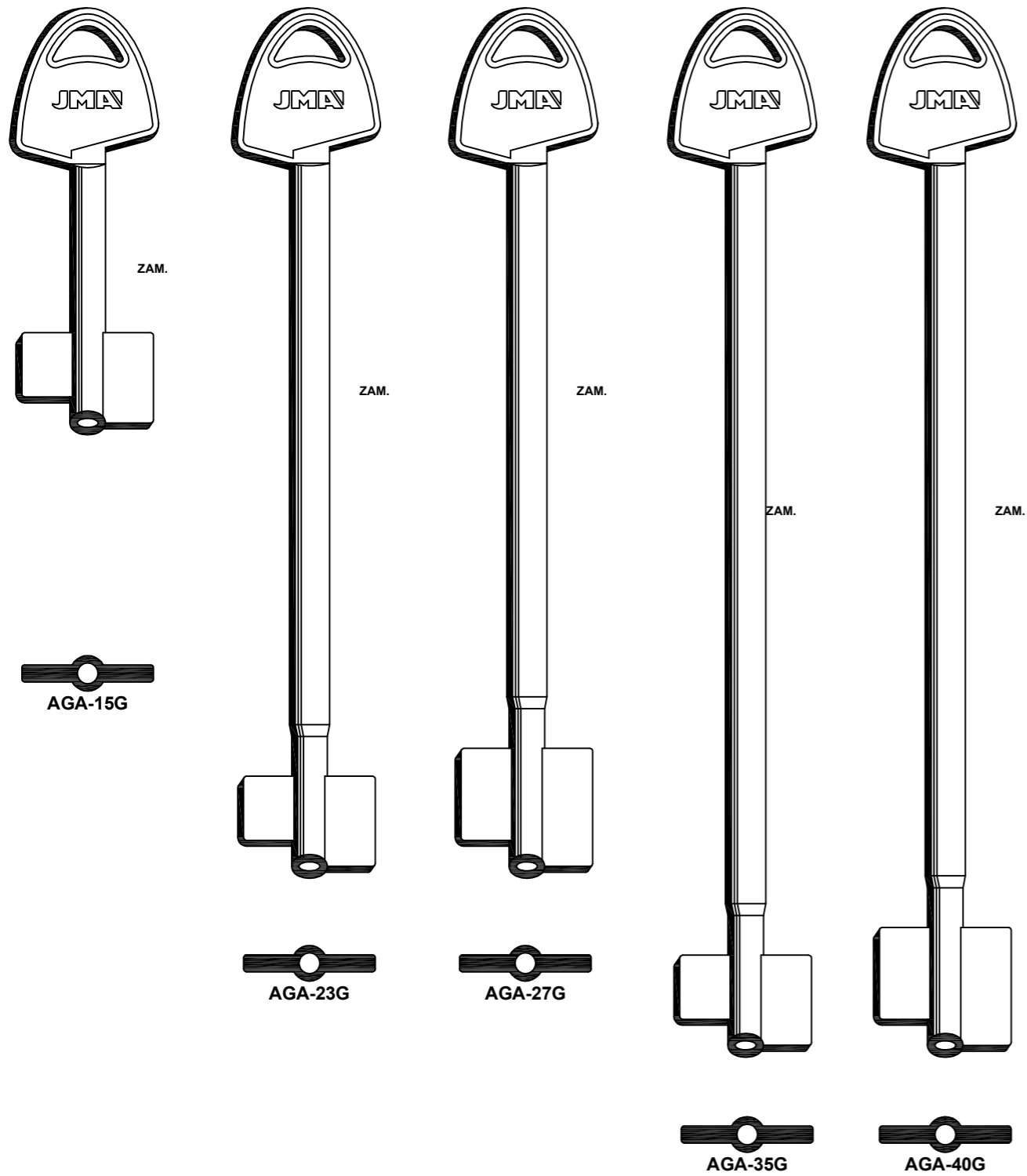

ZAM.



CIS-803/....

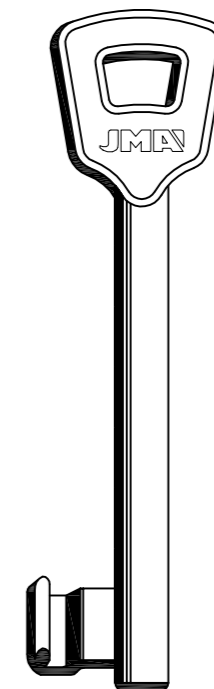

NEF-2Z-..

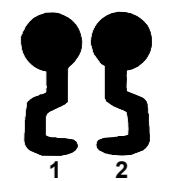

ZAM.

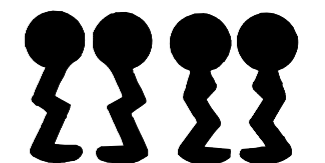
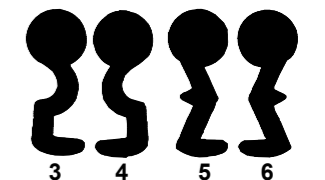

FOR: BMH® -FH® -VACHETTE®

Concerning the marks and commercial denominations see legal warning.
 Concerniente a las marcas y denominaciones comerciales ver aviso legal.
 Marka eta izendapen komertzialiei dagokienez, ikus lege-oharra.
 Concernant les marques et dénominations commerciales voir la note dans l'index.



WARDROBE KEYS

Llaves artísticas
Giltza artistikoak

Clés artistiques/de style
Künstlerische Schlüssel

Chaves artísticas
Klucze ozdobne

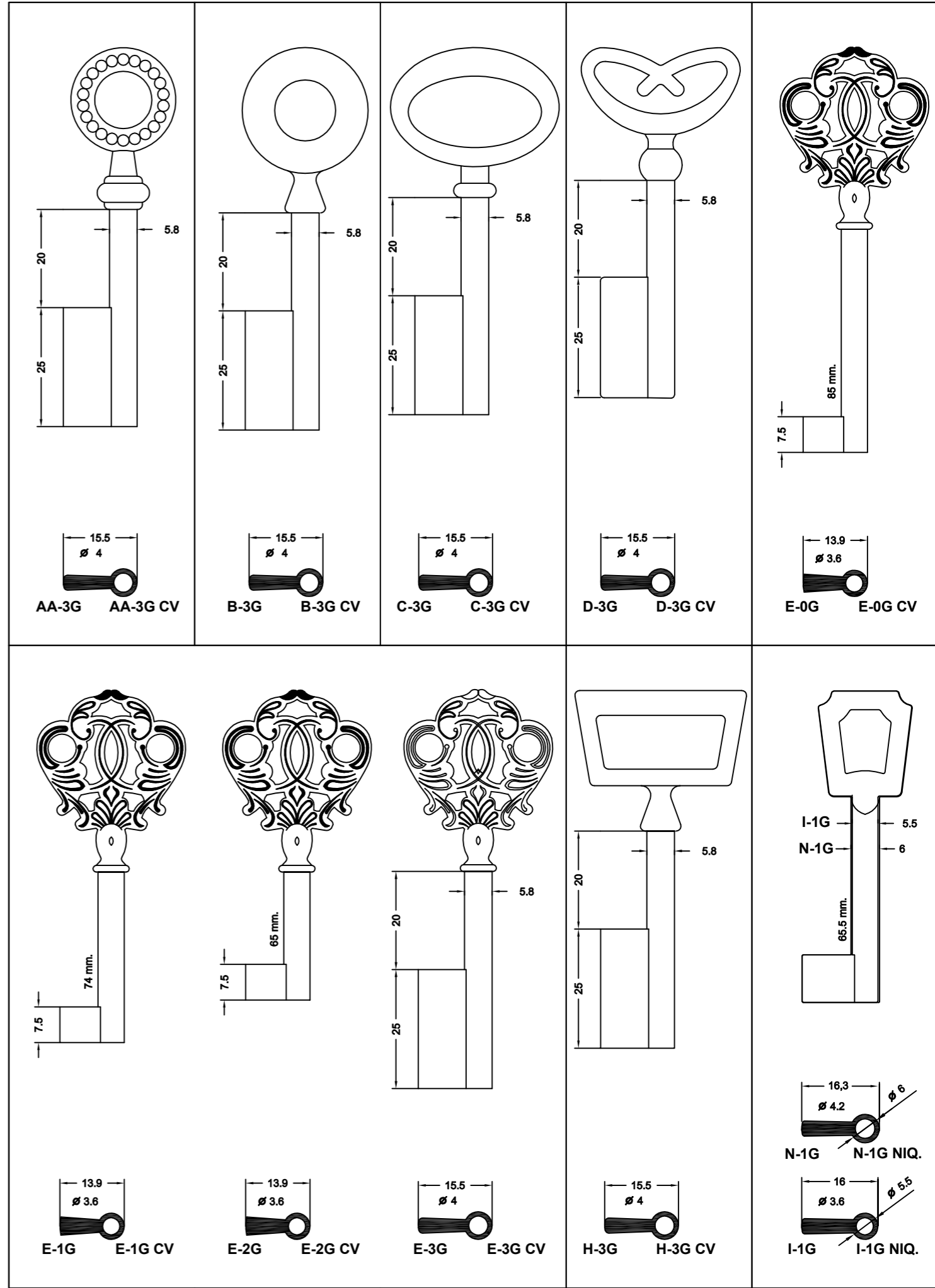
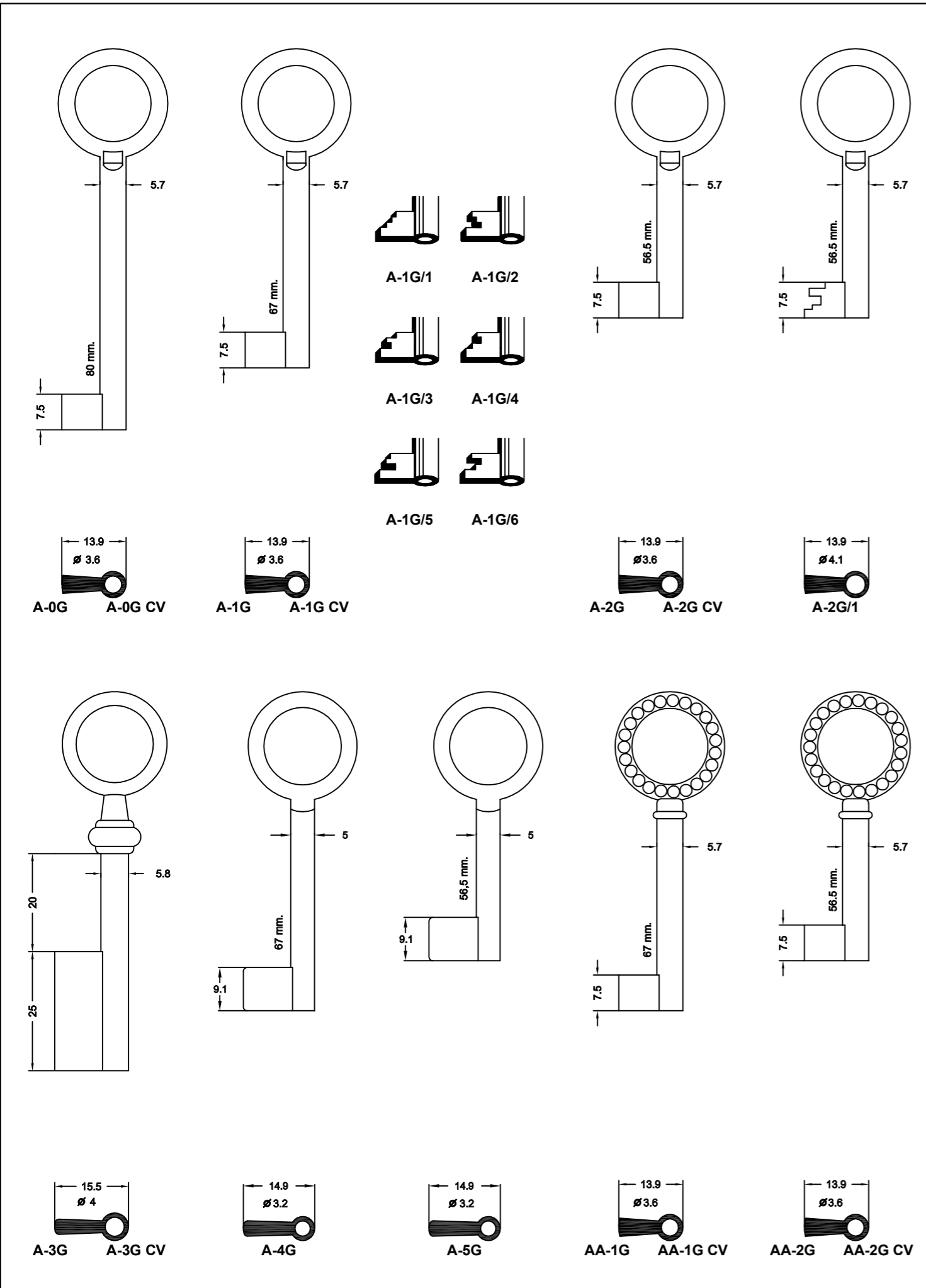

Concerning the marks and commercial denominations see legal warning.
 Concerniente a las marcas y denominaciones comerciales ver aviso legal.
 Marka eta izendapen komertzialiei dagokienez, ikus lege-oharra.
 Concernant les marques et dénominations commerciales voir la note dans l'index.

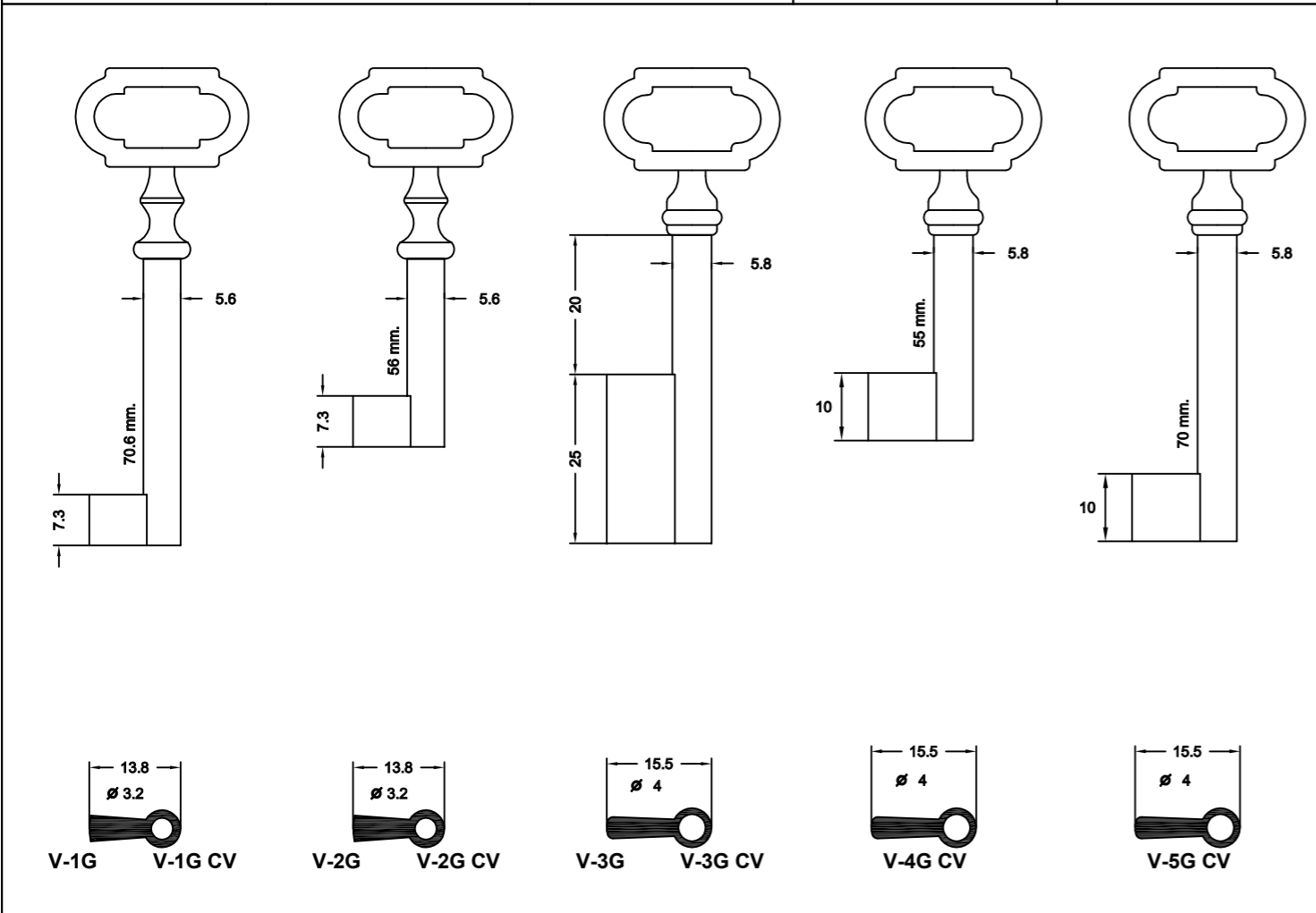
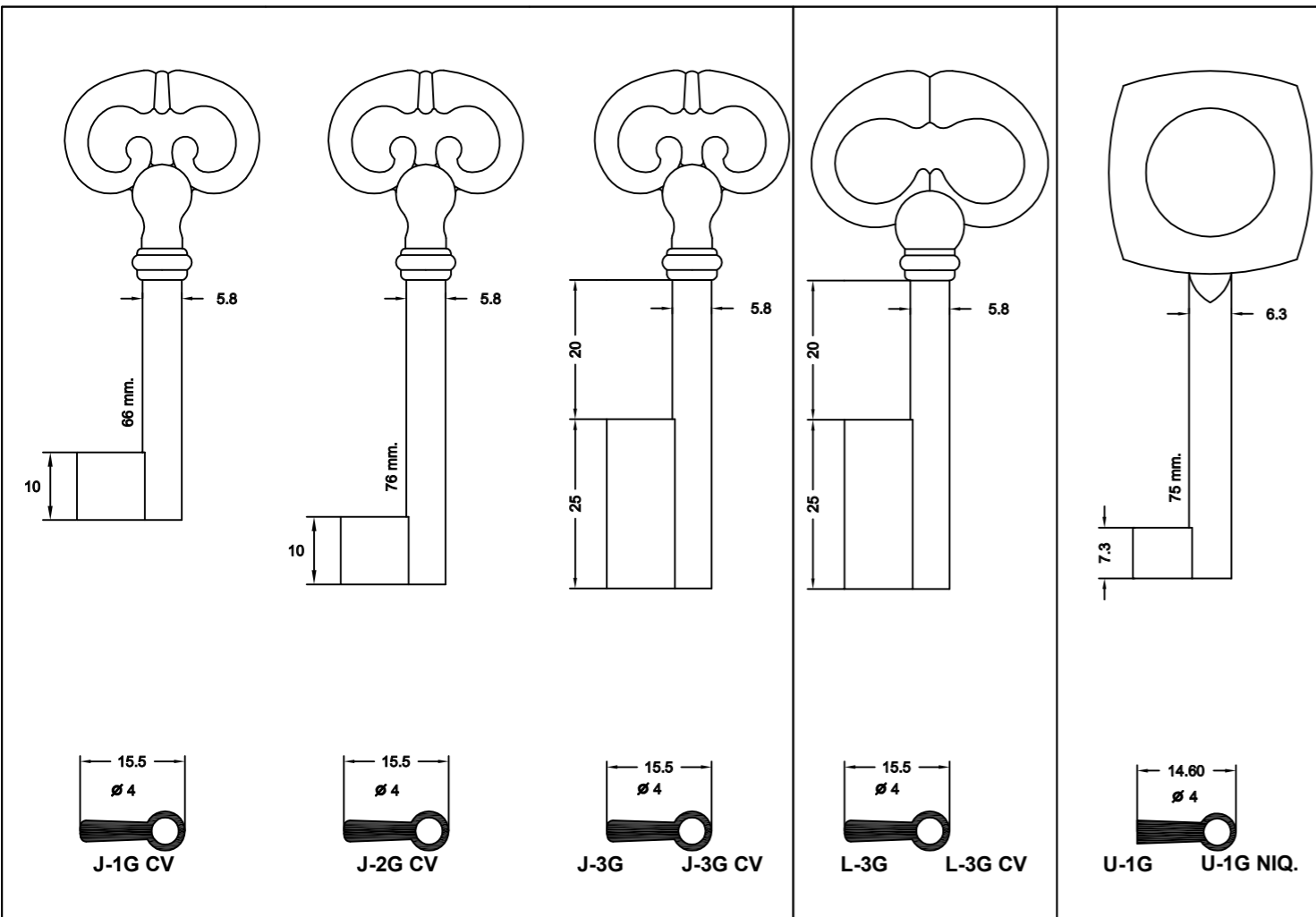

LIFT AND MAIL BOX KEYS

Llaves para casillas
Kutxatilarako giltzak

Clés pour casiers
Künstlerische Schlüssel

Chaves para caixas
Klucze do szafek

Concerning the marks and commercial denominations see legal warning.
Concerniente a las marcas y denominaciones comerciales ver aviso legal.
Marka eta izendapen komertzialiei dagokienez, ikus lege-oharra.
Concernant les marques et dénominations commerciales voir la note dans l'index.



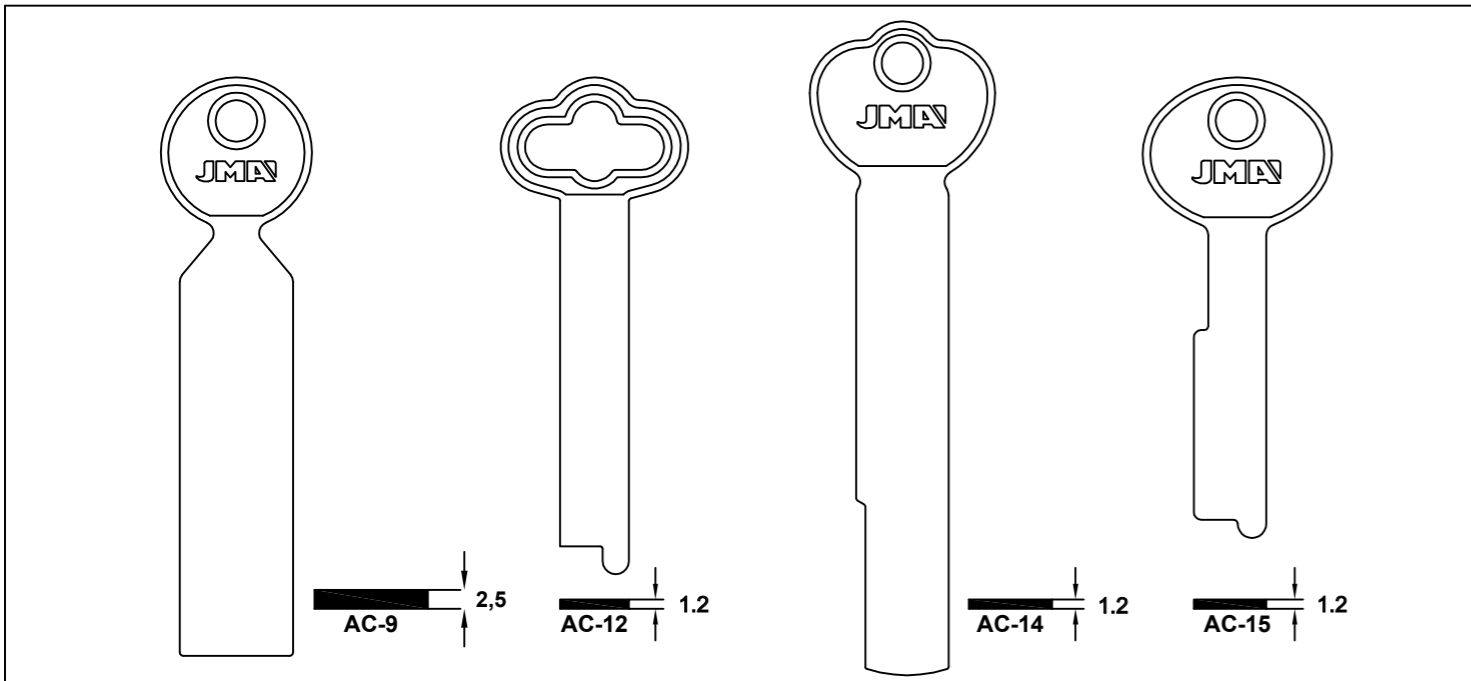

FOR: DIEBOLD® FOR: MILES® FOR: MUEL®

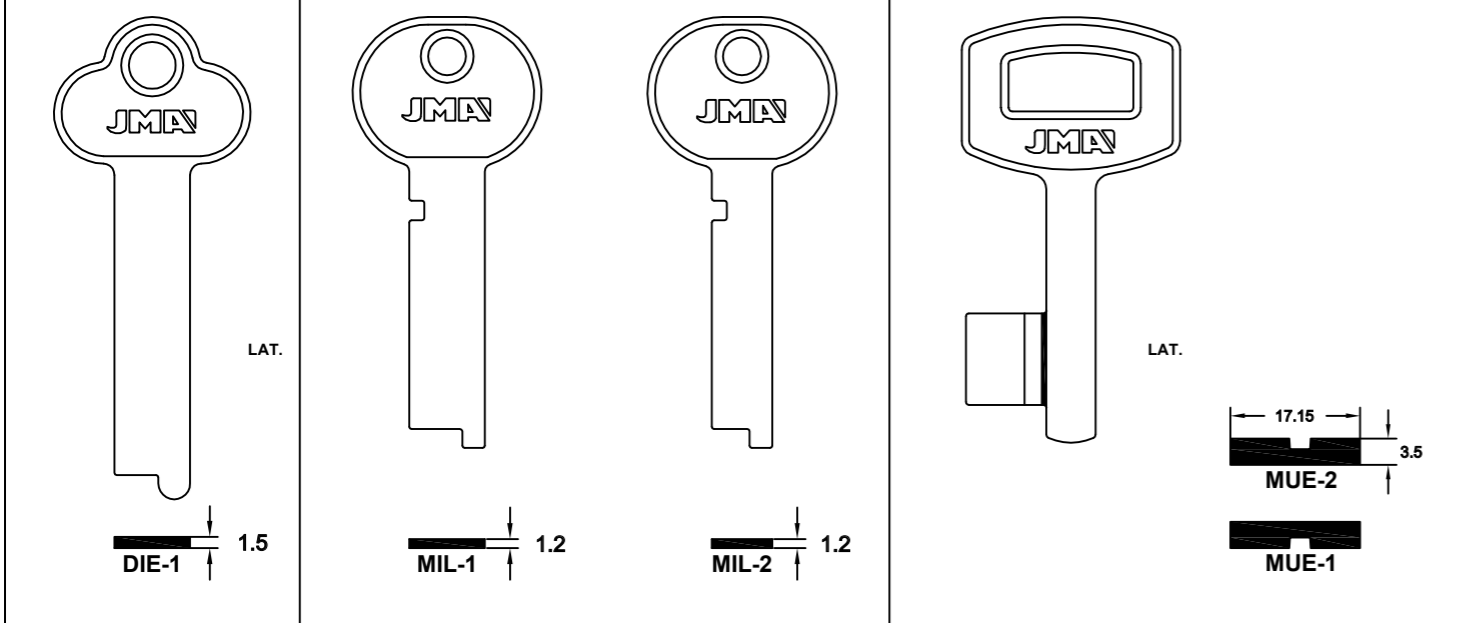

FOR: RIL® FOR: SERRETA® FOR: URKO® FOR: YALE®

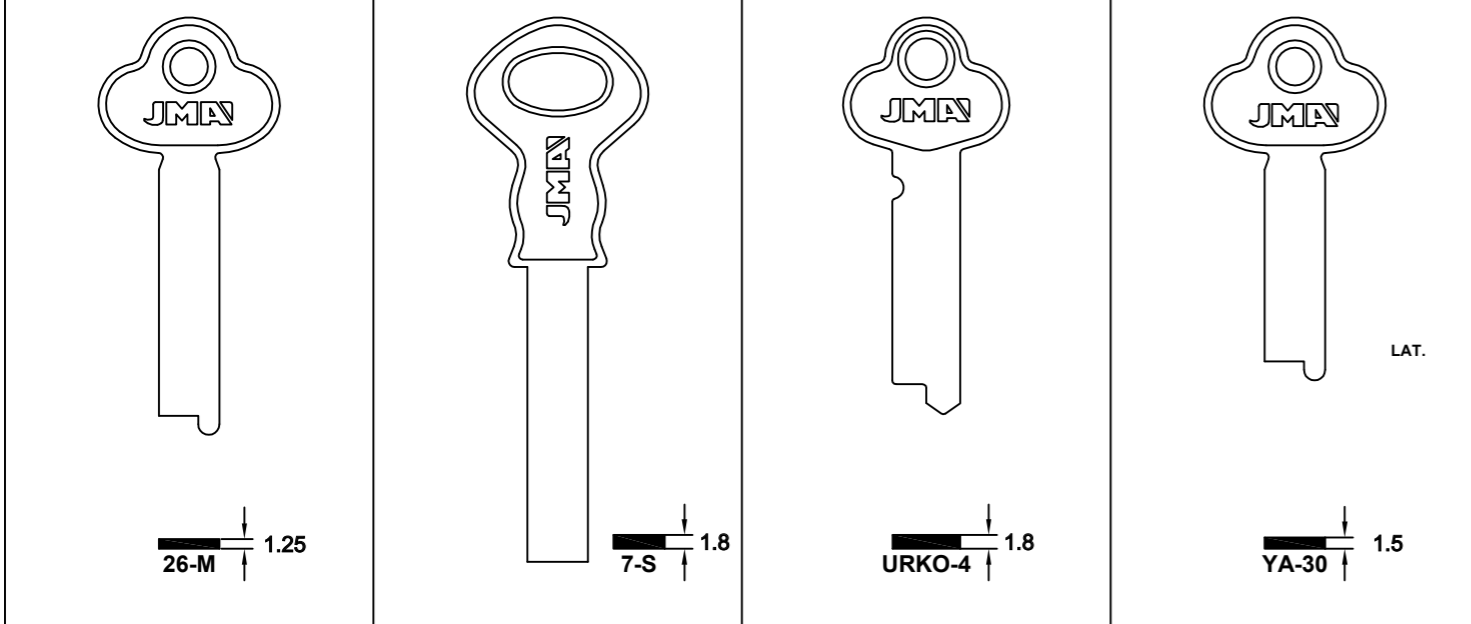

Guide

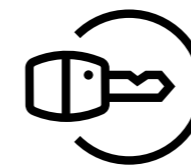



BRAND GUIDES. AUTOMOTIVE

Guía de marcas. Automoción
 Marken gida. Automozioia
 Guide des marques. Automobile
 Markenindex. Automobilindustrie
 Índice de marcas. Automóbel
 Spis marek. Samochodowe

Concerning the marks and commercial denominations see legal warning.
 Concerniente a las marcas y denominaciones comerciales ver aviso legal.
 Marka eta izendapen komertzialiei dagokienez, ikus lege-oharra.
 Concernant les marques et dénominations commerciales voir la note dans l'index.

Automóvil. Camioneta
Automobila. Kamioneta
Voiture. Camionnette

Auto. Kleintransporter
Automóvil. Camioneta
Automóvil. Camioneta

FOR: PARA:	MODEL MODELO			PAG.		PAG.
------------	--------------	---	---	------	---	------

ABARTH	500	2008-	FI-16P1	155	FI-16P1	155
	GRANDE PUNTO	2007-2010			FI-16P1	155
	PUNTO	2012-				
	PUNTO EVO	2010-2012				
	VARIOUS MODELS	-	FI-16C3	354	FI-16C3	354

ABT	GOLF 3	1991-	AU-AH	155	AU-AH	155
			AU-AHP	155	AU-AHP	155
			VO-2	155	VO-2	155
			VO-2P	155	VO-2P	155



ACM	10.1 ENDURO	-19-	NE-15I	155	RO-15	155
	10.4 ENDURO	-19-	NE-15IP	155		
	OFF 4WD	-19-				

ACURA (HONDA)	CL	1995-1998	HOND-16D	156	HOND-16D	156
			HOND-16DP	156	HOND-16DP	156
	INTEGRA	-1989	HOND-10	155	HOND-10	155
	LEGEND	1989-1991	HOND-10P	155	HOND-10P	155
	MODELOS	1986-1988				
	INTEGRA	1990-	HOND-15	156	HOND-15	156
	VIGOR	1992-	HOND-15P	156	HOND-15P	156
	INTEGRA	1990-2000	HOND-16DP	156	HOND-16DP	156
	TL	1995-1998				
	LEGEND	1990-1991	HOND-37DP		HOND-37DP	
	LEGEND	1991-	HOND-17P	156	HOND-17P	156
	NSX	1991-1997	HOND-16D	156	HOND-16D	156
			HOND-16DP	156	HOND-16DP	156
			HOND-16DP1	156	HOND-16DP1	156
	SLX	1996-1999	GM-5	155	GM-5	155
			GM-5P	155	GM-5P	155

ACURA (HONDA) (USA)	TL	2009-2014	KRCHOND-31	360	KRCHOND-31	360
	TSX	2009-2010				
	TSX	2011-2014				

AIXAM	500-4	-	SIX-3P2	156	SIX-3P2	156
	A.721	2004-2009				
	500-4	-19-	SIX-3P	156	SIX-3P	156
			SIX-3P1	156	SIX-3P1	156
	A.741	2004-2009	SIX-3P1	156	SIX-3P1	156
	A.751	2004-2009	SIX-3P2	156	SIX-3P2	156
	CITY	2008-				
	COUPE	2008-	SIX-3P	156	SIX-3P	156
			SIX-3P1	156	SIX-3P1	156
	CROSSLINE	2007-	SIX-3P1	156	SIX-3P1	156
	CROSSOVER	2011-	SIX-3P2	156	SIX-3P2	156
	GTO	2011-				
	ROADLINE	2009-2010	SIX-3P	156	SIX-3P	156
			SIX-3P1	156	SIX-3P1	156
	SCOUTY	2005-2012	SIX-3P1	156	SIX-3P1	156

ALFA ROMEO	10 AR 6	-19-	FI-12	158	FI-12	158
	13 AR 6	-19-	FI-12P	158	FI-12P	158
			FI-12P3	158	FI-12P3	158
			FI-3D	158	FI-3D	158
			FI-3DP3	158	FI-3DP3	158
			FI-6I	158	FI-6I	158
			FI-6IP4	157	FI-6IP4	157
	30 AR 8	-1986	AF-7I	156	IMS-3	159

FOR: PARA:	MODEL MODELO			PAG.		PAG.
------------	--------------	---	---	------	---	------

ALFA ROMEO	35 AR 8	-1986	AF-7IP	156	IMS-3P	159
	40 AR 8	-1986	FI-9I	158	IMS-5	159
			FI-9IP	158	IMS-5P	159
	30 AR 8	1986-	FI-2D	158	FI-2D	158
	35 AR 8	1986-	FI-2DP3	158	FI-2DP3	158
	40 AR 8	1986-	FI-3D	158	FI-3D	158
			FI-3DP1	158	FI-3DP1	158
			FI-6I	158	FI-6I	158
			FI-6IP1	158	FI-6IP1	158
	75 MILANO	1985-	AF-13	157	AF-13	157
			AF-13P	157	AF-13P	157
	75 TD	1987-	FI-3D	158	FI-3D	158
			FI-3DP4	158	FI-3DP4	158
	155 6V	1992-1995	FI-13	158	FI-13	158
	155 T.S.	1992-1995	FI-13P	158	FI-13P	158
	155	1992-1995	FI-14P	159	FI-14P	159
	164 V6	1987-1995	AF-14	157	AF-14	157
	164	1987-1995	AF-14P	157	AF-14P	157
			FI-6I	158	FI-6I	158
			FI-6IP4	157	FI-6IP4	157

	145	1994-	FI-13	158	FI-13	158
			FI-13P	158	FI-13P	158
	147	2000-2009			FI-16P1	159
	156	2001-2007				
	156 SPORT WAGON	2001-2007				
	166	2004-2007				
	GIULIETTA	2010-				
	MITO	2008-2019				
	1750	-19-	AF-7I	156	AF-5D	156
	GIULIA 1600	-19-	AF-7IP	156	AF-5I	156
			NE-25	159	AF-6D	156
			AF-6I	156		



	2000 BERLINA	-19-	AF-7I	156	AF-5D	156
	A 11 D	-19-	AF-7IP	156	AF-5I	156
	A 12 D	-19-			AF-6D	156
	F 11 D	-19-			AF-6I	156
	F 12 D	-19-				
	GIULIA DIES.	-19-				

	2000 COUPE	-19-	SIP-3	159	AF-5D	156
	2000 SPIDER	-19-			AF-5I	156
					AF-6D	156
					AF-6I	156

	33	1983-1986	AF-14	157	AF-14	157
			AF-14P	157	AF-14P	157
			FI-6I	158	FI-6I	158
			FI-6IP4	157	FI-6IP4	157
	33	1986-1990	FI-3D	158	FI-3D	158
			FI-6I	158	FI-6I	158
			FI-3DP4	158	FI-3DP4	158

	33	1990-	AF-14	157	AF-14	157
	75	1990-1991	AF-14P	157	AF-14P	157
	90	1984-1985	FI-6I	158	FI-6I	158
			FI-6IP4	157	FI-6IP4	157

	90	1985-	AF-13	157	AF-13	157
			AF-13P	157	AF-13P	157
	A 11	-19-	BH-8	157	AF-5D	156
	A 12	-19-	AF-5I	156		
	F 11	-19-			AF-6D	156
	F 12	-19-			AF-6I	156
	A 20	-19-	BH-1	157	RO-7D	
	A 38	-19-	BH-1P	157		

FOR: PARA:	MODEL MODELO			PAG.		PAG.
------------	--------------	---	---	------	---	------

ALFA ROMEO	ALFA 6	1984-	FI-6I	158	AF-10	157
			FI-6IP4	157	AF-11	157
					AF-12	157
			IMS-3	159	IMS-3	159
			IMS-5	159	IMS-5P	159
ALFASUD		-19-	AF-7I	156	AF-5D	156
			FAB-1	157		
			AF-7IP	156	AF-5I	156
			FI-6I	158	AF-6D	156
			FI-6IP4	157	AF-6I	156
			FI-9I	158		
			FI-9IP	158		
			SIP-3	159		

	ALFETTA	1978-1982	AF-7I	156	AF-10	157
			IMS-5	159	IMS-5	159

	GIULIETTA	1979-1981	AF-7IP	156	AF-11	157
			IMS-5P	159	IMS-5P	159
					AF-12	157
	ALFETTA	1982-1984	FI-6I	158	AF-10	157
			AF-5D	156	AF-5D	156
			FI-6IP4	157	AF-11	157
			IMS-5	159	IMS-5	159
					AF-12	157

	ALFETTA	1984-	FI-6I	158	AF-10	157
			FI-6IP4	157	AF-11	157
					AF-12	157
			IMS-5P	159	IMS-5P	159

	ALFETTA1.6 1	-19-	AF-7I	156	AF-5D	156
	ALFETTA1.8 1	-19-	AF-7IP	156	AF-5I	156
					AF-6D	156
					AF-6I	156

	ALFETTA1.6 2	-19-	AF-7I	156	AF-10	157
			AF-5D	156	AF-5D	156
	ALFETTA1.6 G	-19-	AF-7IP	156	AF-11	157
			FAB-1	157	FAB-1	157
					AF-12	157

	ALFETTA1.8 2	-19-				
	ALFETTA1.8 G	-19-				
	ALFETTA2.0 G	-19-				
	ARNA 1.2 L	-19-	FI-6I	158	DAT-6	157
	ARNA 1.2 LS	-19-	FI-6IP4	157	DAT-6P	157
	ARNA 1.3 TI	-19-				
	DUETTO	-19-	FI-6I	158	AF-5D	156
			FI-6IP4	157	AF-5I	156
					AF-6D	156
					AF-6I	156

	GIULIA 1300	-19-	AF-7I	156	AF-5D	156
			AF-7IP	156	AF-5I	156
			BH-8	157	AF-6D	156
			NE-25	159	AF-6I	156

	GIULIETTA	1981-	FI-6I	158	GIOB-3P	
			FI-6IP4	157		
			IMS-3	159		

Automóvil. Camioneta
Automobila. Kamioneta
Voiture. Camionnette

Auto. Kleintransporter
Automóvil. Camioneta
Automóvil. Camioneta

FOR: PARA:	MODEL MODELO			PAG.		PAG.
AMERICAN MOTORS ©	ENCORE	1986-1988	NE-19P	160		
	CHEROKEE	-1990	BAS-1I	159	BAS-1I	159
	COMANCHE	-1990	GM-9	160		
	W.BASE	-1990	GM-9P	160		
	W.ISLANDER	-1990	GM-J	160		
	W.LAREDO	-1990	GM-JP	160		
	W.SAHARA	-1990				
	W.TEXAS	-1990				
	WAGONEER	-1990				
	CHEROKEE	1991-1992	CHR-9	160	CHR-9	160
	COMANCHE	1991-1992	CHR-9P	160	CHR-9P	160
	MJ COMANCHE	1993-	CHR-10	160	CHR-10	160
	XJ CHEROKEE	1993-	CHR-10P	160	CHR-10P	160
	YJ WRANGLER	1993-				
	ZJ G.CHEROKEE	1993-				
	VARIOUS MODELS	1953-1969	BS-1I	159	BS-1I	159
	VARIOUS MODELS	1970-1985	BAS-1I	159	BAS-1I	159
	VARIOUS MODELS	1985-1988	AMM-1	159	AMM-1	159
	VARIOUS MODELS	1985-1990	AMM-2	159	AMM-2	159
	VARIOUS MODELS	-	CHR-14	160	CHR-14	160
			CHR-14P	160	CHR-14P	160
			BS-2	159	BS-2	159
			BS-5	159	BS-5	159
			CHR-16		CHR-16	
			NE-19P1	160	NE-19P1	160
			NE-20P	161	NE-20P	161
			NE-20P1	161	NE-20P1	161
			NE-20P2	161	NE-20P2	161
			NE-20P3	161	NE-20P3	161
			NE-22P1	161	NE-22P1	161
			NE-22P2	161	NE-22P2	161
			NE-36	161	NE-36	161
			NE-36P	161	NE-36P	161
			NE-36P1	161	NE-36P1	161
			NE-39P	161	NE-39P	161
	WAGONEER	1991-1992	CHR-9	160	BAS-1I	159
			CHR-9P	160	CHR-9	160
			GM-9	160	CHR-9P	160
			GM-9P	160		
			GM-J	160		
			GM-JP	160		

ARO DACIA ©	203	-19-	BH-1	161	HU-1	162
			BH-1P	161		
	240	1982-1985	BH-1	161	RO-15	162
			BH-1P	161		
	240	1985-	NE-15I	162	RO-15	162
	241	1985-	NE-15IP1	162		
	242	1985-				
	243	1985-				
	244	1985-				
	ISCHIA 10.1	1985-				
	ISCHIA 10.4	1985-				
	SUPER ISCHIA	1985-				

ASTON MARTIN ©	LAGONDA	-19-	FO-E-TC	162	FO-E-TC	162
			IN-1	162	IN-1	162
	LAGONDA LIM.	-19-	FO-E-TCP	162	FO-E-TCP	162
			UN-FP		UN-FP	
	V8 SALOON	-19-	FO-FR	162	IN-1	162

FOR: PARA:	MODEL MODELO			PAG.		PAG.
ASTON MARTIN ©	V8 VANTAGE	-19-	UN-FS	163	UN-FS	163
			FO-FRP	162	OP-WHP	162
			UN-FT	163	UN-FT	163
	V8 VANTAGE Z	-19-	OP-WHP	162	OP-WYP	162
	V8 VOLANTE	-19-	OP-WYP	162	UN-FP	
	V8 VOLANTE C	-19-			UN-FS	163
					UN-FT	163
	VARIOUS MODELS	-19-	FO-TX	162	FO-TX	162
			FO-TXP	162	FO-TXP	162
			OP-WHC1	354	OP-WHC1	354
			WAS-2P	163	WAS-2P	163

AUDI ©	50 GL	1974-	VO-VB	164	VO-VB	164
			AU-W	164	AU-W	164
	50 LS	1974-	VO-VBP	164	VO-VBP	164
	80 GLS	1979-	VO-VB	164	VO-VB	164
			AU-W	164	AU-W	164
			BL-1D	164	BL-1D	164
	80 GT	1979-	VO-VBP	164	VO-VBP	164
	100 GLS	1979-	NE-1	164	AU-W	164
	100 L	1979-	NE-1P	164		
	100	1979-				
	100 L	1973-1977	AU-W	164		
	100 LS	1973-1977				
	100	1973-1977				
	60	-19-				
	100	1978-1982	AU-1	163	AU-1	163
	200	1978-1982	AU-HV	163	AU-HV	163
	4000	1978-1982	AU-HVP	163	AU-HVP	163
	5000	1978-1982	VO-VB	164	VO-VB	164
	80	1978-1982	VO-VBP	164	VO-VBP	164
	100	1985-	AU-AH	163	AU-AH	163
	200	1985-	AU-AHP	163	AU-AHP	163
	4000	1985-	AU-AN	163	AU-AN	163
	5000	1985-	AU-ANP	163	AU-ANP	163
	80	1985-	VO-2	164	VO-2	164
	90	1985-	VO-2P	164	VO-2P	164
	CABRIO	1985-1995				
	COUPE	1985-1995				
	QUATTRO	1985-				
	V8	1985-				
	80	1983-1984	AU-1	163	AU-1	163
			AU-HV	163	AU-HV	163
			AU-HVP1	163	AU-HVP1	163
			VO-HV	164	VO-HV	164
			VO-VB	164	VO-VB	164
			VO-VBP	164	VO-VBP	164
	80	1984-1985	AU-AH	163	AU-AH	163
	QUATTRO	1984-1985	AU-AHP1	163	AU-AHP1	163
			AU-AN	163	AU-AN	163
			AU-ANP	163	AU-ANP	163
			VO-2	164	VO-2	164
			VO-2P	164	VO-2P	164
	A3	1997-2003	KRCHU-HAA	360	KRCHU-HAA	360
	A3	2003-2012				
	A4	1999-2001				
	A6	1998-2004				
	A8	1997-2003				
	Q3	2010-2019				
	S1	2010-2019				
	TT	1999-2002				

FOR: PARA:	MODEL MODELO			PAG.		PAG.
AUDI ©	TT	2002-2005				
	TT	2002-2006				
	TT	2007-2013				
	COUPE GT	1982-1984	AU-1	163	AU-1	163
	QUATTRO	1982-1984	AU-HV	163	AU-HV	163
			AU-HVP	163	AU-HVP	163
			VO-HV	164	VO-HV	164
			VO-VB	164	VO-VB	164
			VO-VBP	164	VO-VBP	164
	FOX	1973-1977	VO-HV	164	VO-HV	164
			VO-HVP	164	VO-HVP	164
	VARIOUS MODELS	-	AU-C	163	AU-C	163
			HU-NAAC2	354	HU-NAAC2	354
			SE-AN	164	SE-AN	164
			VO-HVP1	164	VO-HVP1	164
			HU-HAAC1	354	HU-HAAC1	354
			HU-HAAC2	354	HU-HAAC2	354
			HU-HAAC3	354	HU-HAAC3	354

AUDI (USA) ©	A3	2005-2013	KRCHU-HAA	360	KRCHU-HAA	360
	A4	1997-2005				
	A4	1998-2002				
	A6	1997-2000				
	A6	1998-2004				
	A6	2001-2005				
	A8	1997-2003				
	A8	1997-2005				
	ALLROAD	2001-2005				
	Q3	2015-2019				
	S4	2000-2005				
	TT	2003-2006				
	TT	2007-2013				

AUSTIN ©	SHERPA 185	-19-	LF-BL	164	UN-1FS	165
	SHERPA 230	-19-	LF-RO	164	UN-FT	165
	SHERPA 255	-19-	LF-ROP	164		

AUTOBIANCHI ©	A111	-19-	AF-7I	165	IMS-3	166
			AF-7IP	165	IMS-3P	166
			AF-8DP	165	IMS-5	166
			AF-8I	165	IMS-5P	166
			AF-8IP	165		
			AF-9D	165		
			AF-9DP	165		
			AF-9I	165		
			AF-9IP	165		
	A111	1968-1972	AF-8D	165		
	A112	1971-1977	AF-7I	165	IMS-3	166
			AF-7IP	165	IMS-3P	166
			FI-9I	166	IMS-5	166
			FI-9IP	166	IMS-5P	166
			SIP-3	166		
	A112	1978-1981	AF-7I	165	IMS-3	166
			AF-5D	165	AF-5D	165
			AF-7IP	165	IMS-3P	166
			FO-FR	166	IMS-5	166
			FO-FRP	166	IMS-5P	166
	A112	1981-1984	AF-7I	165	IMS-3	166
			AF-5D	165	AF-5D	165
			AF-7IP	165	IMS-3P	166
			FI-8I	166	IMS-5	166

FOR: PARA:	MODEL MODELO			PAG.		PAG.
AUTOBIANCHI ©			FI-8IP	166	IMS-5P	166
			FI-9I	166		
			FI-9IP	166		
	A112	1984-1986	FI-3D	165	FI-3D	165
			FAB-1	165		
			FI-3DP3	166	FI-3DP3	166
			FI-6I	166	FI-6I	166
			FI-6IP3	166	FI-6IP3	166
					IMS-3	166
					IMS-3P	166

Automóvil. Camioneta
Automobila. Kamioneta
Voiture. Camionnette

Auto. Kleintransporter
Automóvil. Camioneta
Automóvil. Camioneta

FOR: PARA:	MODEL MODELO	CCCCC	PAG.	PAG.
---------------	-----------------	-------	------	------

BERTONE ©	FREECLIMBER	-19-	DAI-1P	167	DAI-1P	167
	SL-CABRIO	-19-	MIT-12	167	MIT-12	167
			MIT-7	167	MIT-7	167
			MIT-7P	167	MIT-7P	167

BMA ©	AMICA 250	-19-	AF-9D	167	UN-MRN	168
	AMICA 360 D	-19-	AF-9DP	168		
	AMICA 50-125	-19-	AF-9I	167		
			AF-9IP	168		
			FEM-1I	168		

BMW ©	524 TD	1984-1986	BM-2	168	BM-2	168
	SERIE 7	1984-1986	BM-2P	168	BM-2P	168
			BM-HB	169	BM-HB	169
			BM-HBP	169	BM-HBP	169
	1502	1968-1976	BM-W	169	BM-B	168
	1600	1968-1976			HU-SX	169
	1602	1968-1976				
	1800	1968-1976				
	1802	1968-1976				
	2000	1968-1976				
	2002	1968-1976				
	2000 TOURING	1968-	BM-W	169	BM-W	169
	2002 TOURING	1979-	BM-W	169	BM-W	169
	2500	1968-	BM-1P	168	BM-1P	168
	2800	1970-1975	BM-1P	168	BM-1P	168
	3000	1970-1975				
	3800	1970-1975				
	BAVARIA	1970-1975				
	SERIE 3	1975-1984	BM-3	168	BM-3	168
	SERIE 5	1975-1984	BM-3P	168	BM-3P	168
SERIE 6	1975-1984	BM-HB	169	BM-HB	169	
SERIE 7	1975-1984	BM-HBP	169	BM-HBP	169	
		BM-NB	169	BM-NB	169	
		BM-NBP	169	BM-NBP	169	
SERIE 3	1987-1990	BM-2	168	BM-2	168	
		BM-2P	168	BM-2P	168	
		BM-NB	169	BM-NB	169	
		BM-NBP	169	BM-NBP	169	
SERIE 3	1990-1995	BM-4	168	BM-4	168	
SERIE 5	1988-1995	BM-5P	168	BM-5P	168	
SERIE 7	1988-1995					
SERIE 8	1988-1995					

BMW ©	VARIOUS MODELS	-	BM-6P	169	BM-6P	169
			BM-6PIC1	169	BM-6PIC1	169

BMW (USA) ©	VARIOUS MODELS	-	BM-6P	169	BM-6P	169
			BM-6PIC1	169	BM-6PIC1	169

BRITISH LEYLAND ©	VARIOUS MODELS	-	STR-3	169	STR-3	169
					UN-2	169

BUICK ©	ALLURE	2005-2009	KRCGM-37	360	KRCGM-37	360
	ENCLAVE	2008-2016				
	LUCERNE	2006-2011				
	NEW LACROSSE	2005-2006				
	NEW LACROSSE	2007-2008				
	ALLURE	2010-2012	KRCOP-11	360	KRCOP-11	360
	ENCORE	2014-2015				
	NEW LACROSSE	2010-2015				

FOR: PARA:	MODEL MODELO	CCCCC	PAG.	PAG.
---------------	-----------------	-------	------	------

BUICK ©	REGAL	2011-2015				
	VERANO	2012-2015				
	LESABRE	2001-2005	KRCGM-28	360	KRCGM-28	360
	RAINIER	2004-2007				
	RENDEZVOUS	2002-2007				
	TERRAZA	2005-2005	KRCGM-27	360	KRCGM-27	360
	TERRAZA	2005-2006				
	VARIOUS MODELS	2009-2019	OP-11C1	354	OP-11C1	354

CADILLAC ©	CTS	2008-2013	KRCGM-37	360	KRCGM-37	360
	DTS	2006-2007				
	DTS	2008-2011				
	ESCALADE	2007-2013				
	DEVILLE	2001-2005	KRCGM-28	360	KRCGM-28	360
	SEVILLE	2001-2004				
	STS	2001-2005				
	SRX	2010-2014	OP-11C1	354	OP-11C1	354

CARBODIES ©	FAIRWAY FX4S	-19-	LF-RO	169	IN-4	169
			LF-ROP	169	IN-5	169
			UN-FS	169		

CHATENET ©	BAROODER	2001-2010	SIX-3P	169	SIX-3P	169
	CH26	2007-				
	CH28	2012-				
	CH30	2010-				
	CH32	2012-				
	MEDIA	2000-2009				
	SPEEDINO	2006-2010				
	STELLA	-19-				

CHEVROLET (KR) ©	OPTRA	2014-2017	DAE-3DP2	170	DAE-3DP2	170
------------------	-------	-----------	----------	-----	----------	-----

CHEVROLET ©	AVEO	2011-	KRCOP-11	360	KRCOP-11	360
	CRUZE	2008-2014				
	ORLANDO	2011-2015				
	SPARK	2015-				
	CAPTIVA	2006-2011	KRCDAE-4	360	KRCDAE-4	360
			VARIOUS MODELS	-	DAT-16	170
			OP-CC	170	OP-CC	170
			OP-NA	170	OP-NA	170
			OP-NB	170	OP-NB	170
			OP-WHC1	354	OP-WHC1	354
	VARIOUS MODELS	2009-2020	OP-11C1	354	OP-11C1	354
			VARIOUS MODELS	-2020	DAE-5P	170

CHEVROLET (USA) ©	AVALANCHE	2007-2013	KRCGM-37	360	KRCGM-37	360
	COBALT	2006-2011				
	EQUINOX	2007-2009				
	EXPRESS	2008-2014				
	HHR	2006-2011				
	IMPALA	2006-2013				
	MALIBU	2004-2005				
	MALIBU	2004-2007				
	MONTE CARLO	2006-2007				
	SILVERADO	2007-2013				
	SUBURBAN	2007-2014				
	TAHOE	2007-2014				
	TRAILBLAZER	2002-2009				
	TRAVERSE	2009-2016				
	CAMARO	2010-2016	KRCOP-11	361	KRCOP-11	361

FOR: PARA:	MODEL MODELO	CCCCC	PAG.	PAG.
---------------	-----------------	-------	------	------

CHEVROLET (USA) ©	COLORADO	2015-2016				
	CRUZE	2011-2015				
	EQUINOX	2010-2015				
	EXPRESS	2015-2016				
	IMPALA	2014-2014				
	MALIBU	2013-2016				
	SILVERADO	2014-2016				
	SONIC	2010-2016				
	SUBURBAN	2015-2016				
	TAHOE	2015-2016				
	CAPTIVA SPORT	2012-2015	KRCDAE-4	360	KRCDAE-4	360
	COLORADO	2004-2012	KRCISU-3D	361	KRCISU-3D	361
	UPLANDER	2005-2009	KRCGM-27	360	KRCGM-27	360
			KRCGM-28	360	KRCGM-28	360
	VENTURE	1999-2000	KRCGM-27	360	KRCGM-27	360
	VENTURE	2001-2005				

CHRYSLER ©	024	1987-	CHR-8	170	CHR-8	170
			CHR-8P	170	CHR-8P	170
	5.TH AVENUE	-19-	CHR-8	170	CHR-8	170
	LEBARON	1989-	CHR-8P	170	CHR-8P	170
	NEW YORKER	-19-				
	ARROW	-19-	MIT-1I	171	MIT-1I	171
	PICK UP	-19-	MIT-1IP	171	MIT-1IP	171
	CHALLENGER	-19-	MIT-2I	171	MIT-2I	171
	CONQUEST	-19-	MIT-2IP	171	MIT-2IP	171
	RAIDER	-19-				
	SAPORO	-19-				
	COLT	1993-	MIT-8D	172	MIT-8D	172
	VISTA	1993-	MIT-8DP	172	MIT-8DP	172
	CONCORDE	1993-	CHR-10	170	CHR-10	170
	FULL SIZE V.	1993-	CHR-10P	171	CHR-10P	171
	IMPERIAL	1993-				
	NEW YORKER	1993-				
	PICK UP	1993-				
	TOWN & CO.	1993-				
	VANS	-19-				
CRICKET	-19-	LF-SL	171	LF-SL	171	
		LF-SLP	171	LF-SLP	171	
D 50	-19-	MIT-1I	171	MIT-1I	171	
		MIT-1IP	171	MIT-1IP	171	

FULL SIZE V.	-19-	CHR-8	170	CHR-8	170
		CHR-8P	170	CHR-8P	170
GR. VOYAGER	1996-1997	CHR-14	171	CHR-14	171
STRATUS	1995-	CHR-14P	171	CHR-14P	171
VIPER	1995-	CHR-15	171	CHR-15	171
VISION	1995-	CHR-15P	171	CHR-15P	171
VOYAGER	1995-				
LEBARON VAN.	-19-	CHR-7	170	CHR-7	170
MOD. USA	1980-1986	CHR-7P	170	CHR-7P	170

MOD. USA	1967-1979	CHR-7	170	CHR-7	170
		CHR-7P	170	CHR-7P	170
MOD. USA	1990-1992				
PT CRUISER	2001-2005	KRCCHR-15	361	KRCCHR-15	361

FOR: PARA:	MODEL MODELO	CCCCC	PAG.	PAG.
---------------	-----------------	-------	------	------

CHRYSLER ©	VARIOUS MODELS	-	BAS-3	172	BAS-3	172
			CHR-1	170	CHR-1	170
			CHR-14	171	CHR-14	171
			CHR-14P	171	CHR-14P	171
			CHR-2	170	CHR-2	170
			CHR-4D	170	CHR-4D	170
			CHR-4I	170	CHR-4I	170
			CHR-16		CHR-16	
			CL-7P	171	CL-7P	171
			YPSILON	2011-	FI-16P1	171

CHRYSLER (USA) ©	200	2011-2014	KRCCHR-15	361	KRCCHR-15	361
	PACIFICA	2004-2008				
	PT CRUISER	2006-2011				
	SEBRING	2007-2011				
SEBRING COUPE	2002-2005					

CITROEN ©	2 CV	1970-	CT-3	172	LAS-P	173
			FAB-1	173	FAB-1	173
			CT-3P	172	RO-4D	175
			CT-4P	173	RO-4I	175
			CT-2P1	172	RO-4D	175

ACADIANE	-19-	CT-3	172	RO-4I	175
		CT-3P	172		
		CT-3P	172		

AMI 6	1969-	CT-3	172	RO-5D	175
		CT-3P	172	RO-5I	175
		CL-8P	172	CL-8P	172
		SIX-1	175	SIX-1	175

AMI 8	1969-	CT-3P	
-------	-------	-------	--

Automóvil. Camioneta
Automobila. Kamioneta
Voiture. Camionnette

Auto. Kleintransporter
Automóvil. Camioneta
Automóvil. Camioneta

FOR: PARA:	MODEL MODELO			PAG.		PAG.
CITROEN®						
	DISPATCH	2005-2009				
	PARTNER	2009-2016				
BX	1990-	NE-36	174	NE-36	174	
		SIX-2P2	175	SIX-2P2	175	
		SIX-1	175	SIX-1P	175	
		SIX-1P	175	SIX-2	175	
		SIX-2	175	SIX-2P	175	
		SIX-2P	175	SIX-2P2	175	
		SIX-2P2	175			
BX	1990-1994	NE-36P1	174	NE-36P1	174	
C1	2004-2014	CIT-1C1	354	CIT-1C1	354	
C2	2002-2005					
C3	2002-2005					
C3 PLURIEL	2002-2006					
C-15 D	-19-	SIX-1	175	SIX-1	175	
		AB-10I	172	AB-10I	172	
C-15 E	-19-	SIX-1P	175	SIX-1P	175	
C-25 FURGON.	-19-	FI-6I	173	FI-6I	173	
		FI-6IP3	173	FI-6IP3	173	
C4 PICASSO	2006-2013	KRCHU-HCA	361	KRCHU-HCA	361	
C4 PICASSO	2007-2010					
C5	2007-2010					
C8	2005-2009					
C8	2009-2014					
DISPATCH	2009-2014					
JUMPY	2006-2009					
JUMPY	2009-2016					
CX	1974-1985	CT-3	172	AB-5D	172	
		LAS-V	173	LAS-V	173	
		CT-3P	172	AB-5I	172	
				RO-5D	175	
				RO-5I	175	
CX	1985-	SIX-1	175	SIX-1	175	
		SIX-1P	175	SIX-1P	175	
		SIX-2	175	SIX-2	175	
		SIX-2P	175	SIX-2P	175	
		SIX-2P	175	SIX-2P	175	
D	-1974	CT-1	172	RO-5D	175	
DS	-1974	CT-1P	172	RO-5I	175	
		CT-3	172			
		CT-3P	172			
DYANE	1967-1980	CT-2	172	RO-4D	175	
		FAB-1	173	FAB-1	173	
		CT-2P	172	RO-4I	175	
		CT-2P1	172			
		CT-3	172			
		CT-3P	172			
DYANE	1980-	SIX-1	175	RO-4D	175	
		SIX-1P	175	RO-4I	175	
		SIX-2	175	SIX-2P2	175	
		SIX-2P	175			
		SIX-2P2	175			
EVASION	1994-	SIX-3P1	175	SIX-3P1	175	
JUMPI	1996-					
G	1970-	CT-3	172	AB-5D	172	
GS	1970-	CT-3P	172	RO-5D	175	
GSA	1970-			RO-5I	175	
JUMPER	1996-	FI-11P	173	FI-11P	173	
JUMPER	2002-2010			FI-16P1	173	

FOR: PARA:	MODEL MODELO			PAG.		PAG.
CITROEN®						
LN	1976-1984	NE-4	173	VA-6	175	
LNA	1976-1984	NE-4P1	174	VA-6P	175	
LNA	1984-	CHR-3	172	VA-6	175	
		PJ-2	174	PJ-2	174	
		CHR-3P	172	VA-6P	175	
		PJ-2P	174			
		NE-22P1	174			
		PJ-K	174			
		PJ-KP	174			
MEHARI	1968-	CT-3	172	RO-4D	175	
		CT-3P	172	RO-4I	175	
		CT-4P	173			
PLUS	-19-	FI-12	173	FI-12	173	
		FI-12P	173	FI-12P	173	
		FI-12P3	173	FI-12P3	173	
		FI-3D	173	FI-3D	173	
		FI-3DP3	173	FI-3DP3	173	
SAXO	1996-	SIX-3P	175	SIX-3P	175	
SM	1970-	CT-3	172	RO-5D	175	
		LAS-V	173	LAS-V	173	
		CT-3P	172	RO-5I	175	
SYNERGIE	1994-1997	SIX-3P	175	SIX-3P	175	
VARIOUS MODELS	-	CHR-4D	172	CHR-4D	172	
		CHR-4I	172	CHR-4I	172	
		FI-16C1	354	FI-16C1	354	
		HU-HCAP	173	HU-HCAP	173	
		NE-4P	174	NE-4P	174	
		NE-4P2	174	NE-4P2	174	
		RO-1D	175	RO-1D	175	
		RO-1DS	172	RO-1DS	172	
		RO-1I	175	RO-1I	175	
		RO-1IS	172	RO-1IS	172	
		RO-2D	175	RO-2D	175	
		RO-2I	175	RO-2I	175	
		RO-6D	175	RO-6D	175	
		RO-6I	175	RO-6I	175	
		SIX-4	175	SIX-4	175	
		SIX-4P	175	SIX-4P	175	
		SIX-5P	175	SIX-5P	175	
		NE-36P	174	NE-36P	174	
		NE-39P	174	NE-39P	174	
		FI-16C3	354	FI-16C3	354	
VARIOUS MODELS	2004-2018	PEU-1C1	355	PEU-1C1	355	
VISA	1979-1985	CHR-3	172	RO-4D	175	
		PJ-2	174	PJ-2	174	
		CHR-3P	172	RO-4I	175	
		NE-22P1	174	RO-5D	175	
		PJ-2P	174			
		PJ-K	174			
		NE-4	173	RO-5I	175	
		PJ-KP	174	PJ-KP	174	
		NE-4P1	174			
VISA	1985-	SIX-1	175	SIX-1	175	
		SIX-1P	175	SIX-1P	175	
		PJ-2P	174			
		PJ-K	174			
		PJ-KP	174			

FOR: PARA:	MODEL MODELO			PAG.		PAG.
CITROEN®						
XANTIA	1993-	SIX-3P	175	SIX-3P	175	
XM	1990-	SIX-3P	175	SIX-3P	175	
ZX	1991-1992	SIX-1	175	SIX-1	175	
		SIX-1P	175	SIX-1P	175	
ZX	1992-1994	SIX-1P2	175	SIX-1P2	175	
DACIA®						
DOKKER	2012-2016	DAC-4DC1	355	DAC-4DC1	355	
SANDERO	2007-2012					
DOKKER	2012-2019	DAC-7DC1	355	DAC-7DC1	355	
SANDERO	2007-2016					
DUSTER	2010-2013	VA-34P	176	VA-34P	176	
LOGAN	2004-2012	VA-34P1	176	VA-34P1	176	
SANDERO	2008-2012	VA-34P2	176	VA-34P2	176	
DUSTER	2012-2016	DAC-6DC1	355	DAC-6DC1	355	
SANDERO	2012-2016					
LOGGY	2012-2016	DAC-4DC1	355	DAC-4DC1	355	
		DAC-7DC1	355	DAC-7DC1	355	
LOGAN	2012-2016	DAC-4DC1	355	DAC-4DC1	355	
		DAC-6DC1	355	DAC-6DC1	355	
		DAC-7DC1	355	DAC-7DC1	355	
VARIOUS MODELS	-	DAC-1DP	175	DAC-1DP	175	
		DAC-2D	175	DAC-2D	175	
		DAC-3DC1	355	DAC-3DC1	355	
		DAC-4DP	176	DAC-4DP	176	
		DAC-5C1	355	DAC-5C1	355	
		DAC-6DP	176	DAC-6DP	176	
DAEWOO®						
DAMA	-19-	DAE-1P	176	DAE-1P	176	
LANOS	1997-	DAE-4P1	176	DAE-4P1	176	
LEGANZA	1997-2000					
LE MANS	1973-1982	OP-6	176	OP-6	176	
		OP-7	176	OP-7	176	
		OP-8	176	OP-8	176	
		OP-9	176	OP-9	176	
		OP-BB	177	OP-BB	177	
		OP-EE	177	OP-EE	177	
		OP-FF	177	OP-FF	177	
LE MANS	1983-1984	OP-D	177	OP-D	177	
		OP-DP	177	OP-DP	177	
		OP-S	177	OP-S	177	
		OP-SP	177	OP-SP	177	
LE MANS	1985-	OP-AB	176	OP-AB	176	
		OP-ABP	177	OP-ABP	177	
		OP-BA	176	OP-BA	176	
		OP-BAP	177	OP-BAP	177	
		OP-J	177	OP-J	177	
		OP-JP	177	OP-JP	177	
LEGANZA	1997-	DAE-4D	176	DAE-4D	176	
		DAE-4DP1	176	DAE-4DP1	176	
NUBIRA	1997-	DAE-3DP1	176	DAE-3DP1	176	
NUBIRA	1997-2000	DAE-3D	176	DAE-3D	176	
TACUMA	2000-2002	DAE-3DP1	176	DAE-3DP1	176	
RACER	-19-	DAE-2DP	176	DAE-2DP	176	
VARIOUS MODELS	-	DAE-3DP2	176	DAE-3DP2	176	
		DAE-5P	176	DAE-5P	176	
DAEWOO (USA)®						
LEGANZA	1998-2005	DAE-4P1	176	DAE-4P1	176	

FOR: PARA:	MODEL MODELO			PAG.		PAG.
DAF®						
46 L	-19-	FO-TC	177	FO-TC	177	
		PJ-1	177	PJ-1	177	
46 STATIONCA	-19-					
46 SUPER L	-19-					
66 GL	-19-					
66 COUPE	-19-	PJ-1	177	PJ-1	177	
66 L	-19-					
66 MARATHON	-19-					
66 SL	-19-					
66 STATIONCA	-19-					
95 XF	1997-	CHR-3P	177	CHR-3P	177	
VARIOUS MODELS	-	HU-SZ	177	HU-SZ	177	
DAIHATSU®						
4 WD TURBO	-19-	TOYO-K1	178			
PIONEER 2800	-19-	TOYO-KIP	178			
TAFT 1600 D.	-19-					
TAFT F10	-19-					
TAFT F20	-19-					
TAFT F201600	-19-					
TAFT F50	-19-					
TAFT F55	-19-					
APPLAUSE	1990-	DAI-1P	177	DAI-1P	177	
CHARADE	1990-					
ROCKY	1990-					
CHARADE	1977-1983	TOYO-K1	178	TOYO-K1	178	
CHARMANT	1983-	TOYO-KIP	178	TOYO-KIP	178	
CHARADE	1983-1989	TOYO-3	178	TOYO-3	178	
		TOYO-3P	178	TOYO-3P	178	
		TOYO-8	178	TOYO-8	178	
		TOYO-8P	178	TOYO-8P	178	
CUORE 850	1986-1991	TOYO-3	178	TOYO-3	178	
		TOYO-3P	178	TOYO-3P	178	
CUORE L55	1976-1998	TOYO-K1	178	TOYO-K1	178	
CUORE L60	1976-1998	TOYO-K1P	178	TOYO-K1P	178	
MIRA	1976-					
FEROZA	1988-	DAI-1P	177	DAI-1P	177	
SPORTTRACK	1991-					
SX 228	1991-					
FOURTRAK 4WD	1984-1988	TOYO-3	178	TOYO-3	178	
		TOYO-8	178	TOYO-8	178	
ROCKY	1984-1988	TOYO-3P	178	TOYO-3P	178	
		TOYO-8	178	TOYO-8	178	
		TOYO-8P	178	TOYO-8P	178	
ROCKY	1989-1990	TOYO-3	178	TOYO-3	178	
		TOYO-3P	178	TOYO-3P	178	
VARIOUS MODELS	-	DAI-2D	178	DAI-2D	178	
DAIMLER®						
DOUBLE SIX C	-1987	FO-FR	178	CENT-3D		
LIMOUSINE	-1987	FO-FRP	178	FO-5	178	
SOVEREIGN V.	-1987	FO-TC	178	FO-TC	178	</

Automóvil. Camioneta
Automobila. Kamioneta
Voiture. Camionnette

Auto. Kleintransporter
Automóvil. Camioneta
Automóvil. Camioneta

FOR: PARA:	MODEL MODELO			PAG.		PAG.
DELTA MOTOR	CRUISER	-19-	TOYO-K1	179	TOYO-K1	179
	MINI WHEEL	-19-	TOYO-KIP	179	TOYO-KIP	179
	EXPLORER	-19-	TOYO-K1	179	DAT-6	179
			TOYO-K1P	179	DAT-6P	179
DISALCAR	IN 32 4X4	-19-	AF-7I	179	IMS-3	180
			AF-5D	179	AF-5D	179
	IN 50 R 4X4	-19-	AF-7IP	179	IMS-3P	180
	IN 60 4X4	-19-			IMS-5	180
	IN 70 B 4X4	-19-			IMS-5P	180
	IN 70 CR 4X4	-19-				
	R 26 4x4	-19-	BH-4	180		
DODGE	1800	-19-	CHR-12	180	WAS-1	181
	400	1985-	CHR-7	180	CHR-7	180
			CHR-7P	180	CHR-7P	180
			CHR-12	180	CHR-12	180
	600 CARAVEL.	1985-1989	CHR-8	180	CHR-8	180
			CHR-13D	180	CHR-13D	180
	LANCER	-19-	CHR-8P	180	CHR-8P	180
	AVENGER	2008-2014	KRCCHR-15	361	KRCCHR-15	361
	CALIBER	2007-2012				
	CARAVAN	2004-2007				
	NITRO	2007-2012				
	CARAVAN	1991-1993	CHR-8	180	CHR-8	180
			CHR-8P	180	CHR-8P	180
	CARAVAN	1993-	CHR-10	180	CHR-10	180
	DAKOTA	1993-	CHR-10P	180	CHR-10P	180
	DAYTONA	1993-				
	INTREPID	1993-				
	RAMCHARGER	1993-				
	SPIRIT	1993-				
	VIPER	1993-				
	COLT	1989-1993	CHR-17	180	CHR-17	180
			MIT-12	181	MIT-12	181
	VISTA	1989-1992	MIT-12	181	MIT-12	181
			MIT-7	180	MIT-7	180
			MIT-7P	180	MIT-7P	180
	COLT	1993-	MIT-13D	181	MIT-13D	181
			MIT-8D	181	MIT-8D	181
	VISTA	1993-	MIT-14D	181	MIT-14D	181
			MIT-8D	181	MIT-8D	181
			MIT-8DP	181	MIT-8DP	181
	DAKOTA	1991-1993	CHR-8	180	CHR-8	180
			CHR-13D	180	CHR-13D	180
	DAYTONA	1991-1993	CHR-8P	180	CHR-8P	180
	DODGE	-19-	CHR-7	180	CHR-7	180
			CHR-7P	180	CHR-7P	180
			CHR-8	180	CHR-8	180
			CHR-8P	180	CHR-8P	180
	DODGE	1985-1986	CHR-7	180	CHR-7	180
	RAM 50	-19-	CHR-7P	180	CHR-7P	180
	DODGE	1986-1990	CHR-8	180	CHR-8	180
	RAM	1986-	CHR-8P	180	CHR-8P	180
	TRAIL DUSTER	1986-				
	DODGE	1991-	CHR-9	180	CHR-9	180
	SPIRIT	1990-1992	CHR-9P	180	CHR-9P	180

FOR: PARA:	MODEL MODELO			PAG.		PAG.
DODGE	DODGE 400	1989-	CHR-7	180		
			CHR-7P	180		
	DODGE 600	1989-	CHR-8	180		
			CHR-8P	180		
	MONACO	1990-1993	VA-10	181	VA-10	181
	NEON	1995-	CHR-9	180	CHR-9	180
			CHR-9P	180	CHR-9P	180
	RAMCHARGER	1981-1992	CHR-7	180	CHR-7	180
			CHR-7P	180	CHR-7P	180
			CHR-8	180	CHR-8	180
			CHR-8P	180	CHR-8P	180
	SHADOW ES	1991-1992	CHR-8	180	CHR-8	180
			CHR-8P	180	CHR-8P	180
	STEALTH	1991-1993	MIT-12	181	MIT-12	181
			MIT-7	180	MIT-7	180
			MIT-7P	180	MIT-7P	180
	VARIOUS MODELS	-	CHR-14	180	CHR-14	180
			CHR-14P	180	CHR-14P	180
	VIPER	1990-1992	CHR-9	180	CHR-9	180
			CHR-9P	180	CHR-9P	180
DS	DS3	2009-2016	KRCCIT-1	361	KRCCIT-1	361
	DS4	2011-2015				
EAGLE	D 50	-19-	MIT-11	181	MIT-11	181
	EAGLE	-19-	NE-19	182	NE-28	182
	MEDALLION	-19-	NE-19P	182	VA-10	182
	EAGLE	1989-1990	MIT-12	182	MIT-12	182
			MIT-7	181	MIT-7	181
			MIT-7P	182	MIT-7P	182
	EAGLE	1990-1992	VA-10	182	VA-10	182
	PREMIER	1990-				
	EAGLE	1993-	MIT-8D	182	MIT-8D	182
			MIT-8DP	182	MIT-8DP	182
	SUMMIT	1989-1992	CHR-17	181	CHR-17	181
			MIT-12	182	MIT-12	182
	TALON	1989-	MIT-12	182	MIT-12	182
			MIT-7	181	MIT-7	181
			MIT-7P	182	MIT-7P	182
	SUMMIT	1993-	MIT-13D	182	MIT-13D	182
			MIT-14D	182	MIT-14D	182
			MIT-8D	182	MIT-8D	182
			MIT-8DP	182	MIT-8DP	182
	VARIOUS MODELS	-	CHR-14	181	CHR-14	181
			CHR-14P	181	CHR-14P	181
	VISION	1993-1998	CHR-10	181	CHR-10	181
			CHR-10P	181	CHR-10P	181
EBRO	F 275	-19-	LMP-1	183	IMS-3	183
	F 350	-19-	LMP-1P	183	IMS-3P	183
			STS-2D	183	IMS-5	183
			STS-2DP	184	IMS-5P	183
	L 35	-19-	LMP-1	183	CL-2I	182
	L 35/1	-19-	LMP-1P	183	CL-3I	182
	L 60	-19-	NE-3	183	FO-OA	183
	L 80	-19-	NE-3P	183	FO-PN	183



FOR: PARA:	MODEL MODELO			PAG.		PAG.
EBRO			NE-3P1	183		
			NE-3P2	183		
	PATROL	1983-	DAT-6	182	DAT-6	182
			DAT-6P	183	DAT-6P	183
	TRADE 2.0	1983-	STS-2D	183	IMS-3	183
	TRADE 2.8	1983-	STS-2DP	184	IMS-3P	183
					IMS-5	183
					IMS-5P	183
	VANETTE	1983-	DAT-6	182	DAT-6	182
			DAT-6P	183	DAT-6P	183
	VARIOUS MODELS	-	NE-3D	183	NE-3D	183
FERRARI	208	1975-1982	NE-25	185	IMS-3	184
	308	1973-1975			IMS-3P	184
	365	1968-			IMS-5	184
	DINO 246	-19-			IMS-5P	184
	208	1982-	NE-25	185	AF-5D	184
			FAR-1D	184		
	308	1975-			AF-5I	184
			FAR-1I	184		
	328	1985-			AF-6D	184
					AF-6I	184
	208 GTS	1982-	AF-7IP1	184		
	348	1984-	FI-6I	184	FI-6I	184
			AF-5D	184	AF-5D	184
	F 40	1984-	FI-6IP	184	FI-6IP	184
	MONDIAL	1984-	FI-6IP2	184	FI-6IP2	184
	TESTA ROSSA	1984-	FI-6IP3	184	FI-6IP3	184
	400	1976-	HU-1	184	AF-5D	184
			FAR-1D	184	FAR-1D	184
	412	1976-	NE-25	185	AF-5I	184
			FAR-1I	184		
	BB 512	1976-			AF-6D	184
					AF-6I	184
	GTO	1984-	NE-25	185	AF-6D	184
	MONDIAL 8	1982-	AF-7I	184	AF-5D	184
			AF-7IP	184	AF-5I	184
			AF-7IP1	184	AF-6D	184
					AF-6I	184
	VARIOUS MODELS	-19-	FI-6IP4	184	FI-6IP4	184
	VARIOUS MODELS	2004-2011	FI-16C3	355	FI-16C3	355
FIAT	126 BIS	1987-1992	FI-3D	186	IMS-3	187
	126 UP	1987-1992	FI-3DP2	186	IMS-3P	187
			FI-3DP3	186	IMS-5	187
			FI-6I	186	IMS-5P	187
			FI-6IP2	186		
	1100	1956-	FEM-1D	185	AF-4D	185
			FEM-1I	185	AF-4I	185
			FEM-2D	185	AF-5D	185
			FEM-2I	185	AF-5I	185
					AF-6D	185
					AF-6I	185
	124	1966-	AF-7I	185	IMS-3	187
			AF-7IP	185	IMS-3P	187



FOR: PARA:	MODEL MODELO			PAG.		PAG.
FIAT			AF-9D	185	IMS-5	187
			AF-9DP	185	IMS-5P	187
			FEM-1D	185		
			FEM-1I	185		
			FEM-2D	185		
			FEM-2I	185		
			FO-FR	187		
			FO-FRP	187		
			SIP-2	188		
	125	-19-	AF-7I	185	IMS-3	187
			AF-7IP	185	IMS-3P	187
			AF-9D	185	IMS-5	187
			AF-9DP	185	IMS-5P	187
			FO-FR	187		
			FO-FRP	187		
			SIP-2	188		
	126	-19-	AF-7I	185	IMS-3	187
			AF-7IP	185	IMS-3P	187
			AF-9D	185	IMS-5	187
			AF-9DP	185	IMS-5P	187
			FI-3D	186		
			FI-3DP2	186		
			FI-9I	186		
			FI-9IP	187		
			FO-FR	187		
			FO-FRP	187		
			SIP-3	188		
	127	1973-				



CAR - PICK-UP TRUCKS



Automóvil. Camioneta
Automobila. Kamioneta
Voiture. Camionnette

Auto. Kleintransporter
Automóvil. Camioneta
Automóvil. Camioneta

FOR: PARA:	MODEL MODELO			PAG.		PAG.
FIAT				FEM-1I 185	AF-5I 185	
				FEM-2D 185	AF-6D 185	
				FEM-2I 185	AF-6I 185	
131	1973-1980			AF-7I 185	IMS-3 187	
				AF-7IP 185	IMS-3P 187	
				AF-8I 185	IMS-5 187	
				AF-8IP 185	IMS-5P 187	
				AF-9I 185		
				AF-9IP 185		
131	1981-			FI-2D 186	FI-3D 186	
				FI-2DP3 186	FI-3DP2 186	
				FI-3D 186	FI-6I 186	
				FI-3DP2 186	FI-6IP 186	
				FI-6I 186		
				FI-6IP 186		
132	1973-			AF-7I 185	IMS-3 187	
				AF-7IP 185	IMS-3P 187	
				FI-8I 186	IMS-5 187	
				FI-8IP 186	IMS-5P 187	
147	1976-			FI-8I 186	IMS-3 187	
				FIA-2 187		
				FI-8IP 186	IMS-3P 187	
				IMS-12 187		
				FI-8IP1 186	IMS-5 187	
				IMS-3 187		
				FI-9I 186	IMS-5P 187	
				IMS-3P 187		
				FI-9IP 187		
				IMS-5 187		
148	1976-			FI-8I 186	IMS-3 187	
				FIA-2 187		
				FI-8IP 186	IMS-3P 187	
				IMS-3 187		
				FI-8IP1 186	IMS-5 187	
				IMS-3P 187		
				FI-9I 186	IMS-5P 187	
				IMS-5 187		
				IMS-5P 187		
				FI-9IP 187		
1500	1967-			FEM-1D 185	AF-5D 185	
				FEM-1I 185	AF-5I 185	
				FEM-2D 185	AF-6D 185	
				FEM-2I 185	AF-6I 185	
				SIP-2 188		
1800	1967-			SIP-2 188	AF-5D 185	
2100	1967-				AF-5I 185	
2300	1967-				AF-6D 185	
					AF-6I 185	
500	1964-			AF-9D 185	AF-5D 185	
				AF-9DP 185	AF-5I 185	
				FEM-1D 185	AF-6D 185	
				FEM-1I 185	AF-6I 185	
				FEM-2D 185		
				FEM-2I 185		
				FO-FR 187		
				FO-FRP 187		
600	1955-			FEM-1D 185	AF-5D 185	
				FEM-1I 185	AF-5I 185	



FOR: PARA:	MODEL MODELO			PAG.		PAG.
FIAT				FEM-2D 185	AF-6D 185	
				FEM-2I 185	AF-6I 185	
850	1964-			AF-7I 185	AF-5D 185	
				AF-7IP 185	AF-5I 185	
				FEM-1D 185	AF-6D 185	
				FEM-1I 185	AF-6I 185	
				FEM-2D 185		
				FEM-2I 185		
				FO-FR 187		
				FO-FRP 187		
				NE-3 187		
				NE-3P 188		
				NE-3P2 188		
ARGENTA	1981-			FI-2D 186	FI-2D 186	
				FI-2DP3 186	FI-2DP3 186	
				FI-3D 186	FI-3D 186	
				FI-3DP2 186	FI-3DP2 186	
CINQUECENTO	1992-1997			FI-11 187	FI-11 187	
				FI-11P 187	FI-11P 187	
COUPE	1994-1995			FI-13 187	FI-13 187	
				FI-13P 187	FI-13P 187	
CROMA	1985-1995			FI-10 185	FI-11 187	
				FI-10P 185	FI-11P 187	
				FI-11 187		
				FI-11P 187		
DINO	-19-			FO-FR 187	IMS-3 187	
				FO-FRP 187	IMS-3P 187	
				SIP-2 188	IMS-5 187	
					IMS-5P 187	
DUCATO	1994-			FI-11 187	FI-11 187	
				FI-11P 187	FI-11P 187	
DUNA	1987-1991			FI-1 185	FI-1 185	
				FI-1P 185	FI-1P 185	
DUNA	1992-			FI-1 185	FI-1 185	
				IMS-3 187		
				FI-11 187	FI-11 187	
				IMS-3P 187		
				FI-11P 187	FI-11P 187	
				IMS-5 187		
				FI-1P 185	FI-1P 185	
				IMS-5P 187		
FIORINO	-19-			AF-7I 185	IMS-3 187	
				AF-7IP 185	IMS-3P 187	
				AF-9D 185	IMS-5 187	
				AF-9DP 185	IMS-5P 187	
				AF-9I 185		
				AF-9IP 185		
				FI-8I 186		
				FI-8IP 186		
				FI-9I 186		
				FI-9IP 187		
PANDA	1980-1985			FI-7I 186	IMS-3 187	
				IMS-12 187		
				FI-8I 186	IMS-3P 187	
				FI-8IP 186	IMS-5 187	
				FI-8IP1 186	IMS-5P 187	
				FI-9I 186		



FOR: PARA:	MODEL MODELO			PAG.		PAG.
FIAT				FI-9IP 187		
				FI-1 185	FI-1 185	
PANDA	1986-1991			FI-1P 185	FI-1P 185	
PANDA	1992-1995			FI-1 185	FI-1 185	
				FI-11 187	FI-11 187	
				FI-11P 187	FI-11P 187	
				FI-1P 185	FI-1P 185	
PUNTO	1993-1995			FI-13 187	FI-13 187	
				FI-13P1 187	FI-13P1 187	
REGATA	1983-			FI-1 185	FI-1 185	
				FI-10 185	FI-11 187	
				FI-10P 185	FI-11P 187	
				FI-11 187	FI-1P 185	
				FI-11P 187		
				FI-1P 185		
RITMO	1978-1983			FI-3D 186	FI-3D 186	
				FAB-2 185		
				FI-3DP 186	FI-3DP 186	
				FI-3D 186	FI-3D 186	
				FI-3DP2 186	FI-3DP2 186	
				FI-6I 186	FI-6I 186	
				FI-6IP 186	FI-6IP 186	
RITMO	1984-1986			FI-1 185	FI-1 185	
STRADA	1984-1986			FI-1P 185	FI-1P 185	
SCUDO	1995-1997			SIX-3P1 188	SIX-3P1 188	
ULYSSE	1994-					
SCUDO	2007-2009			KRCHU-HCA 361	KRCHU-HCA 361	
SCUDO	2009-2016					
ULYSSE	2005-2009					
ULYSSE	2009-2011					
SPIDER EURO.	-19-			AF-7I 185	AF-5D 185	
				AF-7IP 185	AF-5I 185	
					AF-6D 185	
					AF-6I 185	
STRADA	1979-1982			FI-7I 186	FI-7I 186	
				FI-8I 186	FI-8I 186	
				FI-8IP 186	FI-8IP 186	
STRADA	1982-1984			FI-3D 186	FI-3D 186	
				FI-3DP 186	FI-3DP 186	
				FI-6I 186	FI-6I 186	
				FI-6IP 186	FI-6IP 186	
TEMPRA	1989-1995			FI-13 187	FI-13 187	
				FI-13P 187	FI-13P 187	
				FI-14P 187	FI-14P 187	
TIPO	1988-			FI-13 187	FI-13 187	
				FI-13P 187	FI-13P 187	
UNO	1983-			FI-1 185	FI-1 185	
				FI-11 187	FI-11 187	
				FI-11P 187	FI-11P 187	
				FI-1P 185	FI-1P 185	
				IMS-12 187		
				SI-2D 188		
				SI-3D 188		
VARIOUS MODELS	-			AF-1D 185	AF-1D 185	
				15-D 185	15-D 185	
				15-1 185	15-1 185	



FOR: PARA:	MODEL MODELO			PAG.		PAG.
FIAT				AF-1I 185	AF-1I 185	
				AF-2D 185	AF-2D 185	
				AF-2I 185	AF-2I 185	
				FI-16C2	FI-16C2	
				FI-3 186	FI-3 186	
				FI-3DP1 186	FI-3DP1 186	
				FI-3DP4 186	FI-3DP4 186	
				FI-3DP5 186	FI-3DP5 186	
				NE-3D 187	NE-3D 187	
				CL-7P 185	CL-7P 185	
				FI-6IP4 185	FI-6IP4 185	
				FI-16C1 355	FI-16C1 355	
X 1/9	1972-			AF-7I 185	IMS-3 187	
				AF-7IP 185	IMS-3P 187	
					IMS-5 187	
					IMS-5P 187	
FIAT (ARGENTINA)	128	-19-		NE-4 189	NE-46 190	
				NE-4P 190		
133	-19-			NE-3 189		
				NE-3P 189		
				NE-3P2 189		



Automóvil. Camioneta
Automobila. Kamioneta
Voiture. Camionnette

Auto. Kleintransporter
Automóvil. Camioneta
Automóvil. Camioneta

FOR: PARA:	MODELO MODELO			PAG.		PAG.
FIAT (ARGENTINA) ©						
		FI-11P	189	FI-11P	189	
		FI-1P	188	FI-1P	188	
		SI-2D	190	SI-2D	190	
		SI-3D	190	SI-3D	190	
	VARIOUS MODELS	-	NE-3D	189	NE-3D	189
FIAT (BRASIL) ©	ELBA	1992-	FI-1	190	FI-1	190
			IMS-12	190	IMS-12	190
	PREMIO	1992-	FI-11	190	FI-11	190
			IMS-3	190	IMS-3	190
			FI-11P	190	FI-11P	190
			IMS-3P	190	IMS-3P	190
			FI-1P	190	FI-1P	190
			IMS-5	190	IMS-5	190
	PALIO	1996-1997	FI-13P7	190	FI-13P7	190
	UNO	1983-	FI-1	190	FI-1	190
			FI-11	190	FI-11	190
			FI-11P	190	FI-11P	190
			FI-1P	190	FI-1P	190
			SI-2D	190	SI-2D	190
			SI-3D	190	SI-3D	190
FIAT (TURQUIA) © 131		1973-1980	AF-7I	191	IMS-3	191
			AF-7IP	191	IMS-3P	191
			AF-8I	191	IMS-5	191
			AF-8IP	191	IMS-5P	191
			AF-9I	191		
			AF-9IP	191		
	131	1981-	FI-2D	191	FI-3D	191
			FI-2DP3	191	FI-3DP2	191
			FI-3D	191	FI-6I	191
			FI-3DP2	191	FI-6IP	191
			FI-6I	191		
			FI-6IP	191		
	SERCE	-19-	AF-7I	191	IMS-3	191
			AF-7IP	191	IMS-3P	191
			AF-9D	191	IMS-5	191
			AF-9DP	191	IMS-5P	191
			FEM-1D	191		
			FEM-1I	191		
			FEM-2D	191		
			FEM-2I	191		
			FO-FR	191		
			FO-FRP	191		
			SIP-2	192		
	TEMPRA	1989-	FI-13	191	FI-13	191
			FI-13P	191	FI-13P	191
			FI-14P	191	FI-14P	191
FIAT IVECO ©	131 D MAR.	1976-	AF-7I	192	IMS-3	193
			AF-7IP	192	IMS-3P	193
					IMS-5	193
					IMS-5P	193
	180	-1989	IMS-12	193		
	190	-1989				

FOR: PARA:	MODELO MODELO			PAG.		PAG.
FIAT IVECO ©	238	-19-	AF-7I	192	AF-5D	192
			AF-7IP	192	AF-5I	192
			AF-9D	192	AF-6D	192
			AF-9DP	192	AF-6I	192
			AF-9I	192		
			AF-9IP	192		
	900 E	1980-	FI-8I	192	AF-5D	192
			FI-8IP	192	AF-5I	192
					AF-6D	192
					AF-6I	192
	900 T	1976-	AF-7I	192	AF-5D	192
			AF-7IP	192	AF-5I	192
			AF-8D	192	AF-6D	192
			AF-8DP	192	AF-6I	192
			AF-8I	192		
			AF-8IP	192		
			AF-9D	192		
			AF-9DP	192		
			AF-9I	192		
			AF-9IP	192		
	CAMION	1999-	FI-1P8	192	FI-1P8	192
	DAILY 30	-1984	AF-7I	192	IMS-3	193
	DAILY 35	-1984	AF-7IP	192	IMS-3P	193
	DAILY 40	-1984	FI-9I	193	IMS-5	193
	DAILY 50	-1984	FI-9IP	193	IMS-5P	193
	DAILY 30	1985-1988	FI-2D	192	FI-2D	192
			FIS-1D	193		
	DAILY 35	1985-1988	FI-2DP3	192	FI-2DP3	192
	DAILY 40	1985-1988	FI-3D	192	FI-3D	192
	DAILY 50	1985-1988	FI-3DP1	192	FI-3DP1	192
			FI-6I	192	FI-6I	192
			FI-6IP1	192	FI-6IP1	192
	DAILY 30	1989-1991	FI-11	193	FI-11	193
			FIS-1D	193		
	DAILY 35	1989-1991	FI-11P	193	FI-11P	193
	DAILY 40	1989-1991				
	DAILY 45	1989-1991				
	DAILY 49	1989-1991				
	DAILY 50	1989-1991				
	DUCATO 10	-1988	FI-12	192	FI-12	192
	DUCATO 13	-1988	FI-12P1	192	FI-12P1	192
	DUCATO MAXI	-1988	FI-12P3	192	FI-12P3	192
			FI-3D	192	FI-3D	192
			FI-3DP3	192	FI-3DP3	192
			FI-6I	192	FI-6I	192
			FI-6IP3	192	FI-6IP3	192
	DUCATO 10	1989-1996	FI-3D	192	FI-3D	192
	DUCATO 14	1989-1996	FI-3DP3	192	FI-3DP3	192
	DUCATO 4x4	1989-1996	FI-6I	192	FI-6I	192
	DUCATO MAX	1989-1996	FI-6IP3	192	FI-6IP3	192
	FIORINO	-1982	AF-9D	192	IMS-3	193
			AF-9DP	192	IMS-3P	193
			AF-9I	192	IMS-5	193
			AF-9IP	192	IMS-5P	193
			FI-9I	193		
			FI-9IP	193		
	FIORINO	1983-1987	AF-7I	192	IMS-3	193

FOR: PARA:	MODELO MODELO			PAG.		PAG.
FIAT IVECO ©						
			IMS-12	193		
			AF-7IP	192	IMS-3P	193
			IMS-3	193		
			FI-8IP1	193	IMS-5	193
			IMS-3P	193		
			FI-9I	193	IMS-5P	193
			FI-9IP	193		
	FIORINO	1988-1996	FI-11	193	FI-11	193
			IMS-12	193		
	PENNY	-1991	FI-11P	193	FI-11P	193
			IMS-3	193		
			IMS-3P	193		
			IMS-5	193		
			IMS-5P	193		
	MARENGO R.	1985-1996	FI-11	193	FI-11	193
	PANDA	-1994	FI-11P	193	FI-11P	193
	UNO	-1991				
	TALENTO	-19-	FI-6I	192	FI-6I	192
			FI-6IP	192	FI-6IP	192
			CL-7P	192	CL-7P	192
	VARIOUS MODELS	-19-				
FORD ©	B-MAX	2012-	KRCFO-24	361	KRCFO-24	361
	C-MAX	2003-2007				
	C-MAX	2007-2010				
	C-MAX	2011-				
	ECOSPORT	2013-2018				
	FOCUS	2004-2011				
	FOCUS	2011-				
	GALAXY	2006-2014				
	KUGA	2008-2015				
	MONDEO	2011-2014				
	S MAX	2006-2010				
	S MAX	2010-2014				
	S MAX	2011-2015				
	B-MAX	2012-2018	FO-24C2	355	FO-24C2	355
	C-MAX	2003-2010				
	ECO SPORT	2012-2016				
	FOCUS	2004-2010				
	GALAXY	2006-2011				
	KUGA	2008-2012				
	S-MAX	2006-2010				
	BRONCO	2020-2022	FO-24C9	355	FO-24C9	355
	VARIOUS MODELS	2015-2020				
	CAPRI	-19-	FO-E-TC	194	FO-E-TC	194
			BL-2	193	BL-2	193
			FO-E-TCP	194	FO-E-TCP	194
			FO-TC	195	FO-TC	195
			FO-TX	195	FO-TX	195
			FO-TXP	195	FO-TXP	195
	CARGO	-19-	LF-WR	195	LF-WR	195
			UN-FT	196		
			NE-11	195		
			NE-11P	196		
			NE-24	196		
			NE-24P	196		

FOR: PARA:	MODELO MODELO			PAG.		PAG.
FORD ©	CARGO	1987-1990	NE-11	195	LF-WR	195
			UN-FT	196		
			NE-11P	196		
	CARGO	1990-	NE-11	195	NE-11	195
			UN-FT	196		
			NE-11P	196	NE-11P	196
	C-MAX	2010-2019	FO-24C1	355	FO-24C1	355
	FOCUS	2011-2019	FO-24C3	355	FO-24C3	355
	GALAXY	2010-2015				
	C-MAX	2015-2019	FO-24C3	355	FO-24C3	355
	FIESTA	2008-				
	KUGA	2011-				
	MONDEO	2007-				
	PUMA	2019-				
	S-MAX	2010-				
	CONSUL	-19-	FO-E-TC	194	FO-E-TC	194
	CORTINA	-19-	FO-E-TCP	194	FO-E-TCP	194
			FO-TC	195	FO-TC	195
			FO-XR	195	FO-XR	195
	COUGAR	1998-2000	KRCFO-6	361	KRCFO-6	361
	FIESTA	1995-2008				
	FOCUS	1998-2005				
	FUSION	2002-2012				
	KA	2000-2008				

Automóvil. Camioneta
Automobila. Kamioneta
Voiture. Camionnette

Auto. Kleintransporter
Automóvil. Camioneta
Automóvil. Camioneta

FOR: PARA:	MODEL MODELO			PAG.		PAG.	
FORD ®				FO-TX1	195	FO-TX1	195
				FO-TX1P	195	FO-TX1P	195
				FO-TX2	195	FO-TX2	195
				FO-TX2P	195	FO-TX2P	195
				FO-TXP	195	FO-TXP	195
	FIESTA	2008-2017		FO-24C2	355	FO-24C2	355
	MONDEO	2007-2011	KRCFO-24	361	KRCFO-24	361	
	GRANADA	-1986	FO-E-TC	194	FO-E-TC	194	
			FO-E-TCP	194	FO-E-TCP	194	
			FO-TX	195	FO-TX	195	
			FO-TX1	195	FO-TX1	195	
			FO-TX1P	195	FO-TX1P	195	
			FO-TX2	195	FO-TX2	195	
			FO-TX2P	195	FO-TX2P	195	
			FO-TXP	195	FO-TXP	195	
		HA-1D	195				
		HA-1I	195				
MAVERICK	1993-1995	FO-10P	194	FO-10P	194		
MONDEO	1993-1995	FO-6P	193	FO-6P	193		
SCORPIO	1990-1995						
ORION	-1986	FO-E-TC	194	FO-E-TC	194		
		BL-2	193	BL-2	193		
SIERRA	-1986	FO-E-TCP	194	FO-E-TCP	194		
		FO-TX	195	FO-TX	195		
		FO-TX1	195	FO-TX1	195		
		FO-TX1P	195	FO-TX1P	195		
		FO-TX2	195	FO-TX2	195		
		FO-TX2P	195	FO-TX2P	195		
		FO-TXP	195	FO-TXP	195		
PROBE	1993-1996	FO-9D	193	FO-9D	193		
		FO-9DP	194	FO-9DP	194		
RANGER	2011-2015	FO-24C1	355	FO-24C1	355		
		KRCFO-24	361	KRCFO-24	361		
SCORPIO	1988-1990	FO-6P	193	FO-6P	193		
SIERRA	1990-	FO-6P	193	FO-6P	193		
TAURUS	-19-	FO-E-TC	194	FO-E-TC	194		
		FO-E-TCP	194	FO-E-TCP	194		
		HA-1D	195	HA-1D	195		
		HA-1I	195	HA-1I	195		
TOURNEO CONNECT	2013-	FO-24C1	355	FO-24C1	355		
TOURNEO COURIER	2013-						
TRANSIT	2014-2016						
TRANSIT CONNECT	2013-2018						
TRANSIT CUSTOM	2013-2019						
TRANSIT 100D	-19-	FO-TC	195	FO-PRL	195		
TRANSIT F.	-1986	FO-E-TC	194	UN-FT	196		
		FO-E-TCP	194	UN-TF	196		
		FO-TX	195				
		FO-TX1	195				
		FO-TX1P	195				
		FO-TX2	195				
		FO-TX2P	195				
		FO-TXP	195				
TRANSIT F.	1986-	FO-22P	194	FO-22P	194		



FOR: PARA:	MODEL MODELO			PAG.		PAG.	
FORD ®				FO-4P	193	FO-4P	193
		VARIOUS MODELS	-	FO-43D	194	FO-43D	194
				FO-18D	194	FO-18D	194
				FO-35	194	FO-35	194
				FO-36	194	FO-36	194
				FO-8	193	FO-8	193
				FO-FK	194	FO-FK	194
				FO-FKP	194	FO-FKP	194
				FO-OL	194	FO-OL	194
				FO-OR	194	FO-OR	194
				FO-PRR	195	FO-PRR	195
				FO-SR	195	FO-SR	195
				HU-SY	195	HU-SY	195
				LF-5	195	LF-5	195
				LF-5D	195	LF-5D	195
	VARIOUS MODELS	2011-2019	FO-24C8	355	FO-24C8	355	
FORD (ARGENTINA) ®	ESCORT	-1986	FO-E-TC	196	FO-E-TC	196	
			BL-2	196			
			FO-E-TCP	197	FO-E-TCP	197	
			FO-TC	197	FO-TC	197	
			FO-TX	197	FO-TX	197	
			FO-TX1	197	FO-TX1	197	
			FO-TX1P	197	FO-TX1P	197	
			FO-TX2	197	FO-TX2	197	
			FO-TX2P	197	FO-TX2P	197	
			FO-TXP	197	FO-TXP	197	
	ESCORT	1986-1988	FO-4P	196	FO-4P	196	
	SIERRA	1986-1988					
	ESCORT	1988-1995	FO-6P	196	FO-6P	196	
	SIERRA	1988-1990					
	ESCORT VAN	-19-	FO-E-TC	196	FO-E-TC	196	
		FO-E-TCP	197	FO-E-TCP	197		
		FO-TX	197	FO-TX	197		
		FO-TXP	197	FO-TXP	197		
FALCON	-19-	FO-2	196	FO-2	196		
		FO-1	196	FO-1	196		
		GAS-1	197				
FIESTA	1995-1996	FO-6P	196	FO-6P	196		
MONDEO	1995-1996						
GALAXI	1996-	FO-17P	196	FO-17P	196		
GALAXY	-1996	FO-FHP	197	FO-FHP	197		
		VO-HV	197	VO-HV	197		
		VO-HVP	197	VO-HVP	197		
ORION	-19-	FO-ANP	196	FO-ANP	196		
PICK UP	-1993	FO-2	196	FO-2	196		
		FO-1	196	FO-1	196		
PICK UP	1993-1994	FO-15DP	196	FO-15DP	196		
		FO-3D	196	FO-3D	196		
		FO-3DP	196	FO-3DP	196		
		VO-HV	197				
		VO-HVP	197				
PICK-UP	1995-1996	FO-11D	196	FO-11D	196		
RANGER	1993-1994	FO-15DP	196	FO-15DP	196		
		FO-3D	196	FO-3D	196		



FOR: PARA:	MODEL MODELO			PAG.		PAG.	
FORD (ARGENTINA) ®				FO-3DP	196	FO-3DP	196
				VO-HVP	197		
	SIERRA	-1986	FO-E-TC	196	FO-E-TC	196	
			FO-E-TCP	197	FO-E-TCP	197	
			FO-TX	197	FO-TX	197	
			FO-TX1	197	FO-TX1	197	
			FO-TX1P	197	FO-TX1P	197	
			FO-TX2	197	FO-TX2	197	
			FO-TX2P	197	FO-TX2P	197	
			FO-TXP	197	FO-TXP	197	
	SIERRA	1990-	FO-6P	196	FO-6P	196	
	TAURUS	-19-	FO-TX	197	FO-TX	197	
			FO-TXP	197	FO-TXP	197	
	TRANSIT	-19-	FO-4P	196	FO-4P	196	
			FO-6P	196	FO-6P	196	
VARIOUS MODELS	-	VO-HVP1	197	VO-HVP1	197		
FORD (AUSTRALIA) ®	CAPRI	-1978	FO-D	198	FO-TC	198	
			FO-TC	198	FO-XL	198	
	CAPRI	1978-	FO-1	198	FO-1	198	
			FO-2	198	FO-2	198	
			FO-TX	198	FO-TX	198	
			FO-TXP	198	FO-TXP	198	
	EXPLORER	1996-1997	FO-15D	198	FO-15D	198	
	TAURUS	1996-1997	FO-15DP	198	FO-15DP	198	
	TAURUS WAGON	1996-1997					
	FALCON	2002-2008	KRCFO-6	361	KRCFO-6	361	
	TERRITORY	2004-2011					
	FALCON	2005-2008	KRCFO-24	361	KRCFO-24	361	
	FALCON	2008-2011					
	TERRITORY	2009-2011					
	FESTIVA	1993-1994	KI-1D	198	KI-1D	198	
		KI-1DP	198	KI-1DP	198		
FESTIVA	1994-	FO-12	198	FO-12	198		
		FO-12P	198	FO-12P	198		
LASER	1988-1990	FO-14DP	198	FO-14DP	198		
LASER	1990-1993	FO-13DP	198	FO-13DP	198		
TELSTAR	-19-	MAZ-2D	199	MAZ-2D	199		
		MAZ-2DP	199	MAZ-2DP	199		
FORD (BRASIL) ®	CORCEL	-19-	FO-3D	199	FO-3D	199	
			FO-3	199	FO-3	199	
	DEL REY	-19-	FO-3DP	199	FO-3DP	199	
			FO-3P	199	FO-3P	199	
	ESCORT	-1986	FO-E-TC	199	FO-E-TC	199	
			BL-2	199	BL-2	199	
			FO-E-TCP	199	FO-E-TCP	199	
			FO-TC	199	FO-TC	199	
			FO-TX	199	FO-TX	199	
			FO-TX1	199	FO-TX1	199	
			FO-TX1P	199	FO-TX1P	199	
			FO-TX2	199	FO-TX2	199	
			FO-TX2P	200	FO-TX2P	200	
			FO-TXP	200	FO-TXP	200	
	ESCORT	1986-1988	FO-4P	199	FO-4P	199	
ESCORT	1988-1995	FO-6P	199	FO-6P	199		



FOR: PARA:	MODEL MODELO			PAG.		PAG.	
FORD (BRASIL) ®	ESCORT VAN	-19-	FO-E-TC	199	FO-E-TC	199	
	SIERRA	-19-	FO-E-TCP	199	FO-E-TCP	199	
	VERONA	-19-	FO-TX	199	FO-TX	199	
			FO-TXP	200	FO-TXP	200	
	PICK-UP	1995-1996	FO-3P	199	FO-3P	199	
	VARIOS	1996-	FO-17P	199	FO-17P	199	
	FORD (SOUTH AFRICA) ®	SAPPHIRE	1990-	FO-6P	200	FO-6P	200
		SIERRA	1990-				
		SIERRA	-1986	FO-E-TC	200	FO-E-TC	200
				BL-2	200	BL-2	200
				FO-E-TCP	200	FO-E-TCP	200
				FO-TX	200	FO-TX	200
				FO-TX1	200	FO-TX1	200
				FO-TX1P	200	FO-TX1P	200
				FO-TX2	200	FO-TX2	200
			FO-TX2P	200	FO-TX2P	200	
			FO-TXP	200	FO-TXP	200	
SIERRA		1986-1988	FO-4P	200	FO-4P	200	
SIERRA		1988-1990	FO-6P	200	FO-6P	200	
FORD (USA) ®		AEROSTAR	1986-1991	FO-20D	201	FO-20D	201
				FO-1	200	FO-1	200
			FO-8D	201	FO-8D	201	
	AEROSTAR	1991-1996	FO-11D	201	FO-1	200	
	EXPLORER	1991-1996					
	TAURUS S.	1991-1996					
	T-BIRD S.	1991-					
	AEROSTAR	1996-1997	FO-15D	201	FO-15D	201	
	BRONCO PICK	1996-1997	FO-15DP	201	FO-15DP	201	
	EXPLORER	1996-1997					
	TAURUS	1996-1997					
	TAURUS WAGON	1996-1997					
	ASPIRE	1994-	FO-12	201	FO-12	201	
			FO-12P	201	FO-12P	201	
	BRONCO	1967-1989	FO-2	200	FO-1	200	
CROWN	1967-1989						
MUSTANG	1967-1998						
T-B							



Automóvil. Camioneta
Automobila. Kamioneta
Voiture. Camionnette

Auto. Kleintransporter
Automóvil. Camioneta
Automóvil. Camioneta

FOR: PARA:	MODEL MODELO			PAG.		PAG.
FORD (USA) ®	MUSTANG					
	TAURUS					
	THUNDERBIRD					
	WINDSTAR					
	ESCAPE	2001-2016	KRCFO-15D	361	KRCFO-15D	361
	EXPLORER	1998-2015	KRCFO-24	362	KRCFO-24	362
	FOCUS	2000-2015	KRCFO-30D	362	KRCFO-30D	362
	ESCORT	1981-1986	FO-2	200	FO-1	200
	TEMPO GL	1983-1986				
	TEMPO GLS	1983-1986				
	ESCORT	1990-1995	FO-8D	201	FO-8D	201
			FO-8DP	201	FO-8DP	201
	E-SERIES VAN	2008-2012	KRCFO-30D	362	KRCFO-30D	362
	EXPLORER SPORT TRAC	1999-2010				
	F-150	1999-2014				
	F-350 SUPER DUTY	2008-2016				
	F-450 SUPER DUTY	2011-2016				
	F-550 SUPER DUTY	2011-2016				
	FIVE HUNDRED	2005-2007				
	FREESTAR	2004-2007				
	FREESTYLE	2005-2007				
	RANGER	1999-2012				
	FESTIVA	1987-1989	MAZ-6D	202	MAZ-6D	202
	PROBE	1987-1989	MAZ-6DP	202	MAZ-6DP	202
	FESTIVA	1990-	FO-14DP	201		
			FO-7P	201		
	FIESTA	1979	FO-TC	202	FO-TC	202
			LF-SL	202	LF-SL	202
	FIESTA	1979-1984	FO-TX	202	FO-TX	202
	MERKUR	1985-1989	FO-TXP	202	FO-TXP	202
	XR4 TI	1985-1989				
	MERKUR	1990-1992	FO-14DP	201	FO-14DP	201
	PROBE	1990-1992	FO-7P	201	FO-7P	201
	PROBE	1993-1996	FO-9D	201	FO-9D	201
			FO-9DP	201	FO-9DP	201
	SABLE	1987-1989	FO-8D	201	FO-8D	201
			FO-1	200	FO-1	200
	TAURUS	1986-1989	FO-8DP	201	FO-8DP	201
	SCORPIO	1987-	FO-22P	201	FO-22P	201
			FO-E-TC	202		
			FO-4P	201	FO-4P	201
			FO-E-TCP	202		
	SCORPIO	1988-	FO-6P	201	FO-6P	201
			FO-E-TC	202		
			FO-E-TCP	202		
	T-BIRD	1986-1991	FO-11D	201	FO-11D	201
			FO-1	200	FO-1	200
	TEMPO GL	1986-1991	FO-20D	201	FO-20D	201
	TEMPO GLS	1986-1991				
FREIGHTLINER ®	VARIOUS MODELS	1970-	YA-8D	202	YA-8D	202
			CHR-14	202	CHR-14	202
			CHR-14P	202	CHR-14P	202

FOR: PARA:	MODEL MODELO			PAG.		PAG.
GM (BUICK) ®	3.8 P.AVENUE				GM-12	203
	LESABRE	1991-1996			GM-12P	203
	REATA	1992-			GM-H	204
	RIVIERA	1992-1995			GM-HP	204
	CENTURY	1991-1997	GM-8	203	GM-12	203
	LESABRE	1996-1997			GM-14	203
	ROADMASTER	1996-1997			GM-14P	203
					GM-25	203
					GM-25P	203
	REGAL	1988-1990	GM-19P	203		
	REGAL	1991-	GM-20P	203		
	RIVIERA	1995-	GM-14	203	GM-14	203
	SKYLARK	1994-	GM-14P	203	GM-14P	203
			GM-25	203	GM-25	203
			GM-25P	203	GM-25P	203
	RIVIERA 3.8V	1989-1990			GM-11	203
					GM-11P	203
					GM-D	204
					GM-DP	204
	SKYLARK	1992-1993	GM-22	203	GM-22	203
			GM-22P	203	GM-22P	203
			GM-23	203	GM-23	203
			GM-23P	203	GM-23P	203
	VARIOUS MODELS	-	GM-3P	203	GM-3P	203
	VARIOUS MODELS	1935-1966	BAS-11	203	BAS-11	203
	VARIOUS MODELS		BAS-1D	203	BAS-1D	203
	VARIOUS MODELS	1967-	GM-6	203	GM-6	203
			GM-6P	203	GM-6P	203
			GM-7	203	GM-7	203
			GM-7P	203	GM-7P	203
			GM-8	203	GM-8	203
			GM-8P	203	GM-8P	203
			GM-11	203		
			GM-11P	203		
			GM-10	203	GM-10	203
			GM-10P	203	GM-10P	203
	VARIOUS MODELS	1971-	GM-A	204	GM-A	204
			GM-B	204	GM-B	204
	VARIOUS MODELS	1975-	GM-AP	204	GM-AP	204
			GM-BP	204	GM-BP	204
			GM-C	204	GM-C	204
			GM-CP	204	GM-CP	204
			GM-D	204	GM-D	204
			GM-DP	204	GM-DP	204
	VARIOUS MODELS	1973-	GM-8P	203	GM-8P	203
			GM-12P	203	GM-12P	203
			GM-E	204	GM-E	204
			GM-H	204	GM-H	204
			GM-HP	204	GM-HP	204
	VARIOUS MODELS	1974-	GM-9P	203	GM-9P	203

FOR: PARA:	MODEL MODELO			PAG.		PAG.
GM (BUICK) ®					GM-13	203
					GM-13P	203
	VARIOUS MODELS	1978-	GM-J	204	GM-J	204
			GM-JP	204	GM-JP	204
	VARIOUS MODELS	1976-	GM-7	203	GM-11	203
			GM-7P	203	GM-11P	203
			GM-C	204	GM-7	203
			GM-CP	204	GM-7P	203
			GM-C	204	GM-C	204
			GM-CP	204	GM-CP	204
			GM-D	204	GM-D	204
			GM-DP	204	GM-DP	204
	VARIOUS MODELS	1977-	GM-8	203	GM-12	203
			GM-8P	203	GM-12P	203
			GM-E	204	GM-8	203
			GM-EP	204	GM-8P	203
			GM-E	204	GM-E	204
			GM-EP	204	GM-EP	204
			GM-H	204	GM-H	204
			GM-HP	204	GM-HP	204
	VARIOUS MODELS	1979-	GM-6	203	GM-10	203
			GM-6P	203	GM-10P	203
			GM-A	204	GM-6	203
			GM-AP	204	GM-6P	203
			GM-A	204	GM-A	204
			GM-AP	204	GM-AP	204
			GM-B	204	GM-B	204
			GM-BP	204	GM-BP	204
	VARIOUS MODELS	1980-	GM-7	203	GM-11	203
			GM-7P	203	GM-11P	203
			GM-C	204	GM-D	204
			GM-CP	204	GM-DP	204
	VARIOUS MODELS	1981-	GM-8P	203	GM-12P	203
			GM-E	204	GM-H	204
			GM-EP	204	GM-HP	204
	VARIOUS MODELS	1982-	GM-9	203	GM-13	203
			GM-9P	203	GM-13P	203
			GM-J	204	GM-K	204
			GM-JP	204	GM-KP	204
	VARIOUS MODELS	1983-	GM-6	203	GM-10	203
			GM-6P	203	GM-10P	203
			GM-A	204	GM-B	204
			GM-AP	204	GM-BP	204
	VARIOUS MODELS	1984-	GM-6	203	GM-10	203
			GM-6P	203	GM-10P	203
	VARIOUS MODELS	1985-	GM-7	203	GM-7	203
			GM-7P	203	GM-7P	203
			GM-A	204	GM-B	204
			GM-AP	204	GM-BP	204
			GM-C	204	GM-C	204
			GM-CP	204	GM-CP	204

FOR: PARA:	MODEL MODELO			PAG.		PAG.
GM (CADILLAC) ®	ALLANTE	1987-1988			GM-16P	204
	BROUGHAM	1996-1997			GM-12	204
	C.DE VILLE	1991-			GM-12P	204
	ELDORADO-TC	1991-			GM-H	205
	FLEETWOOD	1991-			GM-HP	205
	SEVILLE	1991-				
	ELDORADO-TC	1989-1990			GM-11	204
					GM-11P	204
					GM-D	205
					GM-DP	205
	VARIOUS MODELS	-	GM-3P	204	GM-3P	204
	VARIOUS MODELS	1935-1966	BAS-11	204	BAS-11	204
			GM-6	204	GM-6	204
			GM-6P	204	GM-6P	204
			GM-A	204	GM-A	204
			GM-B	205	GM-B	205
			GM-AP	204	GM-AP	204
			GM-BP	205	GM-B	205
			GM-7	204	GM-7	204
			GM-7P	204	GM-7P	204
			GM-C	204	GM-C	204
			GM-D	205	GM-D	205
			GM-DP	205	GM-DP	205
			GM-CP	204	GM-CP	204
			GM-8	204	GM-8	204
	VARIOUS MODELS	1973-	GM-8P	204	GM-8P	204
			GM-12	204	GM-12	204
			GM-12P	204	GM-12P	204
			GM-E	204	GM-E	204
			GM-H	205	GM-H	205
			GM-HP	205	GM-HP	205
			GM-EP	204	GM-EP	204
			GM-9	204	GM-9	204
			GM-9P	204	GM-9P	204
			GM-13	204	GM-13	204
			GM-13P	204	GM-13P	204
	VARIOUS MODELS	1978-	GM-J	204	GM-J	204
			GM-JP	204	GM-JP	204
			GM-K	205	GM-K	205
			GM-KP	205	GM-KP	205
	VARIOUS MODELS	1976-	GM-7	204	GM-11	204
			GM-7P	204	GM-11P	204
			GM-C	204	GM-7	204
			GM-CP	204	GM-7P	204
			GM-D	205	GM-D	205
			GM-DP	205	GM-DP	205
	VARIOUS MODELS	1977-	GM-8	204	GM-12	204
			GM-8P	204	GM-12P	204
			GM-E	204	GM-8	204
			GM-EP	204	GM-8P	204
					GM-E	204
					GM-EP	204

Automóvil. Camioneta
Automobila. Kamioneta
Voiture. Camionnette

Auto. Kleintransporter
Automóvil. Camioneta
Automóvil. Camioneta

FOR: PARA:	MODEL MODELO			PAG.		PAG.
GM (CADILLAC) ©					GM-H	205
					GM-HP	205
	VARIOUS MODELS	1979-	GM-6	204	GM-10	204
			GM-6P	204	GM-10P	204
			GM-A	204	GM-6	204
			GM-AP	204	GM-6P	204
					GM-A	204
					GM-AP	204
					GM-B	205
					GM-BP	205
	VARIOUS MODELS	1980-	GM-7	204	GM-11	204
			GM-7P	204	GM-11P	204
			GM-C	204	GM-D	205
			GM-CP	204	GM-DP	205
	VARIOUS MODELS	1981-	GM-8	204	GM-12	204
			GM-8P	204	GM-12P	204
			GM-E	204	GM-H	205
			GM-EP	204	GM-HP	205
	VARIOUS MODELS	1982-	GM-9	204	GM-13	204
			GM-9P	204	GM-13P	204
			GM-J	204	GM-K	205
			GM-JP	204	GM-KP	205
	VARIOUS MODELS	1983-	GM-6	204	GM-10	204
			GM-6P	204	GM-10P	204
			GM-A	204	GM-B	205
			GM-AP	204	GM-BP	205
	VARIOUS MODELS	1984-	GM-6	204	GM-10	204
	VARIOUS MODELS	1985-	GM-6P	204	GM-10P	204
			GM-7	204	GM-7	204
			GM-7P	204	GM-7P	204
			GM-A	204	GM-B	205
			GM-AP	204	GM-BP	205
			GM-C	204	GM-C	204
			GM-CP	204	GM-CP	204
GM (CHEVROLET BRA.) ©	CHEVAIR	-19-	OP-WHP	208	OP-WHP	208
	CHEVROLET	1982-1987	OP-WYP	208	OP-WYP	208
	COMMODORE	-19-				
	MONZA	1982-1987				
	OMEGA	-19-				
	CHEVETTE	1987-1989	OP-R	208	OP-R	208
	CHEVROLET	1987-	OP-RP	208	OP-RP	208
			OP-T	208	OP-T	208
			OP-TP	208	OP-TP	208
	CHEVROLET	1989-1990	OP-D	207	OP-D	207
	PANEMA	1989-	OP-DP	208	OP-DP	208
			OP-S	207	OP-S	207
			OP-SP	208	OP-SP	208
	CHEVROLET	1990-	SUZU-7	208	SUZU-7	208
	SPRINT 1.0	-19-	SUZU-7P	208	SUZU-7P	208
	DIPLOMATA	-19-	CHR-8	207	CHR-8	207
			CHR-8P	207	CHR-8P	207

FOR: PARA:	MODEL MODELO			PAG.		PAG.
GM (CHEVROLET BRA.) ©	VARIOUS MODELS	1935-1966	BAS-II	207	BAS-II	207
			BAS-ID	207	BAS-ID	207
	VARIOUS MODELS	1966-	GM-6	207	GM-6	207
			GM-6P	207	GM-6P	207
			GM-10	207	GM-10	207
			GM-10P	207	GM-10P	207
	VARIOUS MODELS	1974-	GM-A	207	GM-A	207
			GM-B	207	GM-B	207
			GM-AP	207	GM-AP	207
			GM-BP	207	GM-BP	207
			GM-7	207	GM-7	207
			GM-7P	207	GM-7P	207
			GM-C	207	GM-C	207
			GM-CP	207	GM-CP	207
			GM-D	207	GM-D	207
			GM-DP	207	GM-DP	207
			GM-8	207	GM-8	207
			GM-8P	207	GM-8P	207
			GM-12	207	GM-12	207
			GM-12P	207	GM-12P	207
			GM-E	207	GM-E	207
			GM-EP	207	GM-EP	207
			GM-H	207	GM-H	207
			GM-HP	207	GM-HP	207
			GM-9	207	GM-9	207
			GM-9P	207	GM-9P	207
	VARIOUS MODELS	1978-	GM-J	207	GM-J	207
			GM-JP	207	GM-JP	207
			GM-K	207	GM-K	207
			GM-KP	207	GM-KP	207
	VARIOUS MODELS	1976-	GM-7	207	GM-11	207
			GM-7P	207	GM-11P	207
			GM-C	207	GM-7	207
			GM-CP	207	GM-7P	207
					GM-C	207
					GM-CP	207
					GM-D	207
					GM-DP	207
	VARIOUS MODELS	1977-	GM-8	207	GM-12	207
			GM-8P	207	GM-12P	207
			GM-E	207	GM-8	207
			GM-EP	207	GM-8P	207
					GM-E	207
					GM-EP	207
					GM-H	207
					GM-HP	207
	VARIOUS MODELS	1979-	GM-6	207	GM-10	207
			GM-6P	207	GM-10P	207
			GM-A	207	GM-6	207
			GM-AP	207	GM-6P	207
					GM-A	207
					GM-AP	207
					GM-B	207

FOR: PARA:	MODEL MODELO			PAG.		PAG.
GM (CHEVROLET BRA.) ©					GM-BP	207
	VARIOUS MODELS	1980-	GM-7	207	GM-11	207
			GM-7P	207	GM-11P	207
			GM-C	207	GM-D	207
			GM-CP	207	GM-DP	207
			GM-8	207	GM-12	207
			GM-8P	207	GM-12P	207
			GM-E	207	GM-H	207
			GM-EP	207	GM-HP	207
			GM-9	207	GM-13	207
			GM-9P	207	GM-13P	207
			GM-J	207	GM-K	207
			GM-JP	207	GM-KP	207
			GM-6	207	GM-10	207
			GM-6P	207	GM-10P	207
			GM-A	207	GM-B	207
			GM-AP	207	GM-BP	207
			GM-6	207	GM-10	207
			GM-6P	207	GM-10P	207
			GM-7	207	GM-7	207
			GM-7P	207	GM-7P	207
			GM-A	207	GM-B	207
			GM-AP	207	GM-BP	207
			GM-C	207	GM-C	207
			GM-CP	207	GM-CP	207
GM (CHEVROLET BRA.) ©	ASTRO VAN	1996-1997	GM-14	205	GM-14	205
	CAVALIER	1996-1997	GM-14P	205	GM-14P	205
	LARGE BLAZER	1996-1997	GM-25	206	GM-25	206
	LARGE PICKUP	1996-1997	GM-25P	206	GM-25P	206
	MODELOS	1995-				
	S-10 BLAZER	1996-1997				
	S-10 PICKUP	1996-1997				
	VENTURE	1997-				
	BERETTA	1987-1990	GM-17P	206	GM-11	205
	CORSICA	1987-1990			GM-11P	205
					GM-D	206
					GM-DP	206
	BERETTA	1991-	GM-18P	206	GM-12	205
	CORSICA	1991-			GM-12P	205
					GM-H	206
					GM-HP	206
	CAMARO	1989-1990			GM-11	205
	CORVETTE	1989-1990			GM-11P	205
					GM-D	206
					GM-DP	206
	CAMARO	1991-			GM-12	205
	CAVALIER RS	1991-			GM-12P	205
	CORVETTE	1991-			GM-H	206
					GM-HP	206
	CAVALIER LS	1991-1992	GM-22	206		
			GM-22P	206		
	CAVALIER LS	1993-	GM-23	206		
			GM-23P	206		
	COLORADO	2004-	TOYO-15	206	TOYO-15	206

FOR: PARA:	MODEL MODELO			PAG.		PAG.
GM (CHEVROLET) ©					TOYO-15P	207
					TOYO-15P	207
	IMPALA	2000-2005	GM-14	205	GM-14	205
			GM-14P	205	GM-14P	205
	KODIAK 6	1997-	GM-8	205	GM-12	205
	MODELOS	1981-	GM-8P	205	GM-12P	205
	WHEELER	1997-	GM-E	206	GM-H	206
			GM-EP	206	GM-HP	206
	LUMINA	1988-1990	GM-19P	206	GM-11	205
					GM-11P	205
					GM-D	206
					GM-DP	206
	LUMINA	1991-	GM-20P	206	GM-12	205
					GM-12P	205
					GM-H	206
					GM-HP	206
	SPARK	-19-	DAE-3P2	205	DAE-3P2	205
	SPECTRUM	1985-1989	GM-2	205	GM-2	205
			GM-2P	205	GM-2P	205
	SPRINT	1985-1988	GM-1P	205	GM-1P	205
			MIT-2I	206	MIT-2I	206
	VARIOUS MODELS	-	GM-3P	205	GM-3P	205
			GM-26	206	GM-26	206
			BAS-II	205	BAS-II	205
			BAS-ID	205	BAS-ID	205
			GM-6	205	GM-6	205
			GM-10	205	GM-10	205
			GM-6P	205	GM-6P	205
			GM-10P	205	GM-10P	205
			GM-A	206	GM-A	206
			GM-B	206	GM-B	206
			GM-AP	206	GM-AP	206
			GM-BP	206	GM-BP	206
			GM-7	205	GM-7	205
			GM-7P	205	GM-7P	205
			GM-C	206	GM-C	206
			GM-CP	206	GM-CP	206
		</				

Automóvil. Camioneta
Automobila. Kamioneta
Voiture. Camionnette

Auto. Kleintransporter
Automóvil. Camioneta
Automóvil. Camioneta

FOR: PARA:	MODEL MODELO	CCCCC		PAG.		PAG.
GM (CHEVROLET) ®				GM-DP	206	
				GM-H	206	
				GM-HP	206	
GM (OLDS MOBILE) ®	98 REGENCY	1991-		GM-12	209	
	DELTA 88 RO.	1992-		GM-12P	209	
	TORONADO	1991-		GM-H	210	
				GM-HP	210	
	ACHIEVA	1992-1993		GM-22	210	
				GM-22P	210	
				GM-23	210	
				GM-23P	210	
	ACHIEVA	1994-		GM-14	210	GM-14
	AURORA	1995-		GM-14P	210	GM-14P
				GM-25	210	GM-25
				GM-25P	210	GM-25P
	ALERO	2000-2004		GM-14	210	GM-14
	INTRIGUE	2000-2003		GM-14P	210	GM-14P
	CUTLASS	1988-1990		GM-19P	210	
	SILHOUETTE	1988-1990				
	CUTLASS SUP.	1991-		GM-20P	210	
	VARIOUS MODELS	-		BAS-II	209	BAS-II
				BAS-ID	209	BAS-ID
				GM-6	209	GM-6
				GM-10	209	GM-10
				GM-6P	209	GM-6P
				GM-A	210	GM-A
				GM-B	210	GM-B
				GM-AP	210	GM-AP
				GM-BP	210	GM-BP
				GM-7	209	GM-7
				GM-7P	209	GM-7P
				GM-11P	209	GM-11P
				GM-C	210	GM-C
				GM-CP	210	GM-CP
				GM-DP	210	GM-DP
				GM-8	209	GM-8
				GM-12	209	GM-12
				GM-8P	209	GM-8P
				GM-12P	209	GM-12P
				GM-E	210	GM-E
				GM-H	210	GM-H
				GM-EP	210	GM-EP
				GM-HP	210	GM-HP
				GM-9	209	GM-9
				GM-13	209	GM-13
				GM-9P	209	GM-9P
				GM-13P	209	GM-13P
				GM-J	210	GM-J
				GM-K	210	GM-K
				GM-JP	210	GM-JP
				GM-KP	210	GM-KP
	TORONADO	1989-1990		GM-11	209	
				GM-11P	209	

FOR: PARA:	MODEL MODELO	CCCCC		PAG.		PAG.
GM (OLDS MOBILE) ®				GM-D	210	
				GM-DP	210	
GM (PONTIAC) ®	BONNEVILLE	1992-		GM-12	211	
	FIREBIRD	1991-		GM-12P	211	
	FORMULA	1991-		GM-H	211	
	GTA	1991-		GM-HP	211	
	TRANS AM	1991-				
	GRAND AM	1992-1993		GM-22	211	
	SUNBIRD	1992-1993		GM-22P	211	
				GM-23	211	
				GM-23P	211	
	GRAND AM	1994-		GM-14	211	GM-14
				GM-14P	211	GM-14P
				GM-25	211	GM-25
				GM-25P	211	GM-25P
	GRAND AM	2000-2005		GM-14	211	GM-14
				GM-14P	211	GM-14P
	GRAND PRIX	1991-1994		GM-20P	211	
	LE MANS	1987-		OP-S	212	OP-S
				OP-SP	212	OP-SP
	SUNFIRE	2000-2005		GM-25	211	GM-25
				GM-25P	211	GM-25P
	TORRENT	2000-2005		GM-14	211	GM-14
				GM-14P	211	GM-14P
	TRANS SPORT	1988-1990		GM-19P	211	
	VARIOUS MODELS			BAS-II	210	BAS-II
				BAS-ID	210	BAS-ID
				GM-6	210	GM-6
				GM-10	211	GM-10
				GM-6P	210	GM-6P
				GM-10P	211	GM-10P
				GM-A	211	GM-A
				GM-B	211	GM-B
				GM-AP	211	GM-AP
				GM-BP	211	GM-BP
				GM-7	210	GM-7
				GM-11	211	GM-11
				GM-7P	210	GM-7P
				GM-11P	211	GM-11P
				GM-C	211	GM-C
				GM-D	211	GM-D
				GM-CP	211	GM-CP
				GM-DP	211	GM-DP
				GM-8	210	GM-8
				GM-12	211	GM-12
				GM-8P	210	GM-8P
				GM-12P	211	GM-12P
				GM-E	211	GM-E
				GM-H	211	GM-H
				GM-EP	211	GM-EP
				GM-HP	211	GM-HP
				GM-9	210	GM-9
				GM-13	211	GM-13
				GM-9P	210	GM-9P

FOR: PARA:	MODEL MODELO	CCCCC		PAG.		PAG.
GM (PONTIAC) ®				GM-13P	211	GM-13P
				GM-J	211	GM-J
				GM-K	211	GM-K
				GM-JP	211	GM-JP
				GM-KP	211	GM-KP
				GM-7	210	GM-11
				GM-7P	210	GM-11P
				GM-C	211	GM-7
				GM-CP	211	GM-7P
						GM-C
						GM-CP
						GM-D
						GM-DP
						GM-8
				GM-8P	210	GM-12P
				GM-E	211	GM-8
				GM-EP	211	GM-8P
						GM-E
						GM-EP
						GM-H
						GM-HP
GM (SATURN) ®	SATURN	1990-1994		GM-21	212	GM-21
				GM-21P	212	GM-21P
GM ®	BLAZER	-19-		GM-14P	202	GM-14P
	CORSA	-19-		OP-SP	202	OP-SP
	PICK UP C10	-19-		GM-25P	202	GM-25P
	VECTRA	-19-		OP-WHP	202	OP-WHP
				OP-WYP	202	OP-WYP
GMC ®	ACADIA	2007-2016		KRCGM-37	362	KRCGM-37
	ENVOY	2002-2009				
	SAVANA	2003-2007				
	SAVANA	2008-2019				
	SIERRA	2007-2013				
	YUKON	2007-2013				
	CANYON	2004-2012		KRCISU-3D	362	KRCISU-3D
	CANYON	2015-2016		KRCOP-11	362	KRCOP-11
	SIERRA	2015-2016				
	YUKON	2015-2016				
	TILTMASTER W7	2008-2011		ISU-5		ISU-5
	VARIOUS MODELS	2015-2019		OP-11C1	355	OP-11C1
HAMOMAG HENSCHTEL ®	F 20	-19-		ME-VA	212	ME-VA
	F 35	-19-				
HOLDEN ®	APOLLO	1991-		TOYO-14		TOYO-14
	NOVA	1991-		TOYO-14P		TOYO-14P
	ASTRA	1986-		DAT-12	212	DAT-12
	ASTRA	1998-2004		KRCOP-S	362	KRCOP-S
	BARINA	1981-1990		MIT-II	213	MIT-II
	CAMIRA	1980-		MIT-IIP	213	MIT-IIP
	DROVER	1981-		TOYO-14		TOYO-14
	GEMINI	1980-1984		TOYO-14P		TOYO-14P
	JACKAROO	1980-				

FOR: PARA:	MODEL MODELO	CCCCC		PAG.		PAG.
HOLDEN ®	RODEO	1980-				
	SHUTTLE	1980-				
	BARINA	1991-1993		SUZU-10	213	SUZU-10
				SUZU-10P	213	SUZU-10P
	BARINA	1994-		OP-S	213	OP-S
				OP-SP	213	OP-SP
	BELMOND	1971-1978		GM-6	212	GM-6
	KINGSWOOD	1971-1978		GM-6P	212	GM-6P
	STATESMAN	1972-1978		GM-A	212	GM-A
	TORANA	1971-1972		GM-AP	213	GM-AP
	BELMOND	-1979		GM-42	212	GM-42
	CALAIS	1978-				
	COMMODORE	1978-				
	KINGSWOOD	1979-				
	STATESMAN	1978-				
	CALAIS	1993-		OP-WHP	213	OP-WHP
	COMMODORE	1993-				
	COMMODORE	1987-1993		OP-WHP	213	OP-WHP
				OP-WYP	213	OP-WYP
	FJ	-19-		HUD-1	213	HUD-1
	GEMINI	1985-		GM-2	212	GM-2
	SPECTRUM	1985-		GM-2P	212	GM-2P
	GEMINI STAT.	1981-		MIT-II	213	OP-AB
				MIT-IIP	213	OP-ABP
				TOYO-14		OP-BA
				TOYO-14P		OP-BAP
						OP-J
						OP-JP
	MODELLOS	1955-1970		BAS-II	212	BAS-II
	TORANA	-1971		BAS-II	212	UN-FS
	VARIOUS MODELS	-19-		OP-WHC1	356	OP-WHC1
	VARIOUS MODELS	2003-2014		OP-11C1	355	OP-11C1
HONDA ®	ACCORD	1976-1980		HOND-1	214	HOND-1
				HOND-1P	214	HOND-1P
				HOND-2	214	HOND-2
				HOND-2P	214	HOND-2P
	ACCORD	1981-1982		HOND-10	214	HOND-10
	ACCORD	1984-1990		HOND-10P	214	HOND-10P
	PRELUDE	1983-1988				
	QUINTET	1981-1983				
	ACCORD	1982-1983		HOND-10	214	HOND-10
				HOND-10P	214	HOND-10P
				HOND-11	214	HOND-11

Automóvil. Camioneta
Automobila. Kamioneta
Voiture. Camionnette

Auto. Kleintransporter
Automóvil. Camioneta
Automóvil. Camioneta

FOR: PARA:	MODEL MODELO			PAG.		PAG.
HONDA ®	CIVIC	2014-2016				
	CR-V	2012-2013				
	CR-V	2014-2016				
	FRV	2007-2009				
	JAZZ	2001-2003				
	JAZZ	2006-2008				
	JAZZ	2013-				
	ACCORD 2 LS	1993-1995	NE-35	215	NE-35	215
	ACCORD 2 S	1993-1995	NE-35P2	215	NE-35P2	215
	CIVIC	1995-				
	CONCERTO	1989-				
	ACCORD COUPE	1993-1995	HOND-14	214	HOND-14	214
	CIVIC	1988-1995	HOND-14P	214	HOND-14P	214
	ACCORD EX	1991-1995	HOND-16D	215	HOND-16D	215
			HOND-16DP	215	HOND-16DP	215
	CITY JAZZ	1981-1985	HOND-10	214	HOND-10	214
			HOND-10P	214	HOND-10P	214
	CIVIC	1972-1973	NE-1	215	HOND-3D	214
			HOND-14	214	HOND-14	214
			NE-1P	215		
			HOND-14P	214	HOND-14P	214
	CIVIC	1973-1976	HOND-1	214	HOND-1	214
			HOND-1P	214	HOND-1P	214
			HOND-2	214	HOND-2	214
			HOND-2P	214	HOND-2P	214
	CIVIC	1977-1981	HOND-10	214	HOND-10	214
			HOND-10P	214	HOND-10P	214
			HOND-11	214	HOND-11	214
			HOND-11P	214	HOND-11P	214
	CIVIC	1982-1983	HOND-12	214	HOND-12	214
			HOND-12P	214	HOND-12P	214
			HOND-13	214	HOND-13	214
			HOND-13P	214	HOND-13P	214
	CIVIC	1984-1987	HOND-10	214	HOND-10	214
	PRELUDE	1989-1991	HOND-10P	214	HOND-10P	214
	CIVIC CRX	1989-1992	HOND-14	214	HOND-14	214
	CIVIC SHUTLE	1989-1992	HOND-14P	214	HOND-14P	214
			HOND-15	215	HOND-15	215
			HOND-15P	215	HOND-15P	215
	COUPE	1969-1975	NE-1	215	HOND-14	214
	LIFE	1969-1975	NE-1P	215	HOND-14P	214
	N 360	1969-1975				
	TOURER	1969-1975				
	PASSPORT	1995-1998	GM-5P	214	GM-5P	214
	PRELUDE	1982-	HOND-12	214	HOND-12	214
			HOND-12P	214	HOND-12P	214
			HOND-13	214	HOND-13	214
			HOND-13P	214	HOND-13P	214
	PRELUDE	1992-1997	HOND-14	214	HOND-14	214
			HOND-14P	214	HOND-14P	214
			HOND-16D	215	HOND-16D	215
			HOND-16DP	215	HOND-16DP	215
HONDA (AUSTRALIA) ®	ACCORD	2003-2007	KRCHOND-31	362	KRCHOND-31	362
HONDA (USA) ®	ACCORD	2003-2004	KRCHOND-21	362	KRCHOND-21	362
			KRCHOND-31	362	KRCHOND-31	362

FOR: PARA:	MODEL MODELO			PAG.		PAG.
HONDA (USA) ®	ACCORD	2005-2007	KRCHOND-31	362	KRCHOND-31	362
	ACCORD	2008-2012				
	ACCORD CROSSTOUR	2010-2012				
	CIVIC	2002-2005				
	CIVIC	2006-2011				
	CR-V	2002-2004				
	CR-V	2005-2006				
	CR-V	2007-2013				
	CR-V	2012-2013				
	CR-V	2014-2016				
	CR-Z	2011-2015				
	FIT	2007-2008				
	FIT	2009-2013				
	INSIGHT	2010-2014				
	JAZZ	2006-2007				
	ODYSSEY	2005-2010				
	PILOT	2005-2015				
	RIDGELINE	2006-2014				
	CIVIC	2001-2002	KRCHOND-21	362	KRCHOND-21	362
HUMMER ®	H2	2005-	RE-1D	215	RE-1D	215
	H2	2008-2009	KRCGM-37	362	KRCGM-37	362
	H3	2006-2010				
	H3	2005-	BL-2	215	BL-2	215
HYUNDAI ®	ACCENT	1994-1996	HY-5	216	HY-5	216
	EXCEL	1994-1995	HY-5P	216	HY-5P	216
	CRETA	2014-2019	HY-11DP1	217	HY-11DP1	217
	ELANTRA	2007-2016				
	GENESIS COUPE	2010-2013				
	SANTAFE	2007-2010				
	SONATA	2005-2010				
	ELANTRA	1991-1996	HY-4	216	HY-4	216
	LANTRA	1991-1996	HY-4P	216	HY-4P	216
			HY-4P2	216	HY-4P2	216
			HY-4P3	216	HY-4P3	216
	ELANTRA	2000-2006	KRCHY-4	362	KRCHY-4	362
	MATRIX	2001-2006				
	SANTA FE	2001-2006				
	TERRACAN	2001-2007				
	EXCEL	1986-1989	HY-3D	215	HY-3D	215
			HY-3DP	215	HY-3DP	215
	EXCEL	1990-1991	HY-3D	215	HY-3D	215
			HY-3DP1	216	HY-3DP1	216
			KAW-4	217	KAW-4	217
	GRAND STAREX	2007-2015	KRCHY-11	362	KRCHY-11	362
	H1	2007-2015				
	H1-BUS	2007-2015				
	I10 EUROPE	2008-2013				
	HB20 (BRAZIL)	2012-	HY-11DP1	217	HY-11DP1	217
	I10 EUROPE	2014-	KRCKI-7	362	KRCKI-7	362
	I30	2007-2011				
	I30	2012-2016				
	IX35	2011-				
	I20	2008-2012	KRCTOYO-18	363	KRCTOYO-18	363
	PONY	1974-1979	HY-1	215	HY-1	215
	PONY	1980-1984	TOYO-14	217	TOYO-14	217

FOR: PARA:	MODEL MODELO			PAG.		PAG.
HYUNDAI ®		TOYO-14P	217	TOYO-14P	217	
		KAW-4	217	KAW-4	217	
	PONY	1991-	HY-3D	215	HY-3D	215
	S COUPE	1991-1996	HY-3DP1	216	HY-3DP1	216
	SONATA	1991-1996				
	PONY (CAN)	1985-1987	MIT-2I	217	MIT-2I	217
			MIT-2IP	217	MIT-2IP	217
	PONY (EU)	1985-1987	HY-2	215	HY-2	215
	STELLAR	1985-1987	HY-2P	215	HY-2P	215
			HY-7P	216	HY-7P	216
	SONATA	1989-1990	HY-3	215	HY-3	215
			HY-3P2	216	HY-3P2	216
	SONATA (USA)	1993-1995	HY-6D	216	HY-6D	216
	SONICA	1993-1995	HY-6DP	216	HY-6DP	216
	STAREX	1998-	HY-9P2	216	HY-9P2	216
	TIBURON	2001-	HY-4	216	HY-4	216
			HY-4P	216	HY-4P	216
			HY-4P2	216	HY-4P2	216
			HY-4P3	216	HY-4P3	216
	TRAJET	2000-2007	KRCHY-6D	362	KRCHY-6D	362
	VAN TRANSP.	1994-1997	HY-8	216	HY-8	216
			HY-8P	216	HY-8P	216
			HY-10	216	HY-10	216
	VARIOUS MODELS		HY-19DP5	217	HY-19DP5	217
			HY-19P5	217	HY-19P5	217
			HY-3DP2	216	HY-3DP2	216
	VARIOUS MODELS	2006-2020	HY-11P3	217	HY-11P3	217
	VARIOUS MODELS	2007-2016	HY-11DP3	217	HY-11DP3	217
	VARIOUS MODELS	2011-2015	HY-11P4C1	217	HY-11P4C1	217
HYUNDAI (AUS) ®	ILOAD	2007-2014	KRCHY-11	363	KRCHY-11	363
	IMAX	2007-2015				
	LANTRA	2000-2006	KRCHY-4	363	KRCHY-4	363
	LAVITA	2000-2006				
HYUNDAI (CANADA) ®	SANTAFE	2007-2010	HY-11DP1	217	HY-11DP1	217
HYUNDAI (USA) ®	ELANTRA	2011-2015	KRCHY-11	363	KRCHY-11	363
	SONATA	2011-2014				
	SONATA	2011-2012	HY-18P3		HY-18P3	
	TUCSON	2012-				
	VARIOUS MODELS	2012-	HY-11P3	218	HY-11P3	218
INFINITI (NISSAN) ®	G 20	1992-	DAT-10	218	DAT-10	218
	M 30	1992-	DAT-10P	218	DAT-10P	218
			DAT-7	218	DAT-7	218
			DAT-7P	218	DAT-7P	218
			DAT-7P1	218	DAT-7P1	218
	M 30	1990-1991	DAT-13	218	DAT-13	218
			DAT-13P	218	DAT-13P	218
			DAT-14	218	DAT-14	218
			DAT-14P	218	DAT-14P	218

FOR: PARA:	MODEL MODELO			PAG.		PAG.
INFINITI (NISSAN) ®	VARIOUS MODELS		DAT-16	218	DAT-16	218
INFINITI (USA) ®	FX35	2003-2008	KRCDAT-15	363	KRCDAT-15	363
	FX45	2003-2008				
	G20	2000-2002				
	I30	2000-2001				
	I35	2002-2004				
	QX4	2000-2003				
	QX56	2004-2007				
INNOCENTI ®	3 CILINDROS	1982-			AF-10	219
					FAR-1D	219
	MINI 650	1985-			AF-11	219
					FAR-1I	219
	MINI DIESEL	1984-			AF-12	219
	MINI MILLE	1980-				
	MINI TRE	1984-				
	MINI TURBO	1983-				
	500	1986-	FI-6I	219	FI-6I	219
			FAR-1D	219	FAR-1D	219
	650	1986-	FI-6IP	219	FI-6IP	219
			FAR-1I	219	FAR-1I	219
	990	1986-	FI-6IP	219	FI-6IP	219
	SMALL 500	1986-				
	SMALL 990	1986-				
	A40	-19-	UN-FP	220	UN-FP	220
	ELBA	1992-	FI-1I	219	FI-1I	219
			FI-11P	219	FI-11P	219
	J 4	-19-	LF-BL	220	UN-FS	220
	J 5	-19-	UN-FS	220		
	JM 3	-19-				
	MINI 850	-19-				
	MINI 1000	1973-				
	MINI 1001	1973-				
	MINI COOPER	1973-				
	KORAL 45	1990-1992	FI-6I	219	FI-3D	219
	KORAL 55	1990-1992	FI-6IP	219	FI-3DP	219
					FI-3DP5	219
	M.COOPER OR.	-19-	STR-2		STR-2	
	M.MK II 850	-19-	UN-FS	220	UN-FS	220
	M.DE TOMASO	1976-	AF-7I	219	AF-10	219
	MINI 90	1974-	AF-7IP	219	AF-11	219
			FAR-1D	219	FAR-1D	219
	MINI 120	1974-			AF-12	219
			FAR-1I	219	FAR-1I	219
	M.METALLICA	-19-	LF-RO	220	UN-FS	220
			PJ-K	220	PJ-K	220
	M.T.CLUBMAN	-19-	LF-ROP	220		
			PJ-KP	220	PJ-KP	220
	MINI MATIC	1970-	LF-BL	220	AF-10	219
			FAR-1D	219	FAR-1D	219
			UN-FS	220	AF-11	219
			FAR-1I	219	AF-12	219
					UN-FS	220
	REGENT	-19-	LF-BL	220	UN-FT	220

Automóvil. Camioneta
Automobila. Kamioneta
Voiture. Camionnette

Auto. Kleintransporter
Automóvil. Camioneta
Automóvil. Camioneta

FOR: PARA:	MODEL MODELO	CCCCC	PAG.	PAG.			
INNOCENTI ©	VARIOUS MODELS	-19-	FI-6IP3	219	FI-6IP3	219	
			FI-6IP4	219	FI-6IP4	219	
INTER. HARVESTER ©	T.TERRENO	-19-	GM-6	220	GM-10	220	
			GM-6P	220	GM-10P	220	
			GM-A	220	GM-B	221	
			GM-AP	220	GM-BP	221	
			VARIOUS MODELS	1940-1975	KEN-1	221	KEN-1
			HUD-1	221	HUD-1	221	
IRMSCHER ©	4.0 I	-1981	GM-9	221	OP-R	221	
			GM-9P	221	OP-RP	221	
			GM-J	221	OP-T	221	
			GM-JP	221	OP-TP	221	
			OP-R	221	OP-R	221	
	4.0 I	1981-1986	OP-RP	221	OP-RP	221	
			OP-T	221	OP-T	221	
			OP-TP	221	OP-TP	221	
			OP-R	221	OP-R	221	
			OP-RP	221	OP-RP	221	
	4.0 I	1986-	OP-WHP	221	OP-WHP	221	
			C.40 E	-19-	OP-WYP	221	OP-WYP
	ISUZU ©	AMIGO	1988-1991	GM-4	222	GM-4	222
		TF	1988-1991	GM-4P	222	GM-4P	222
				GM-4P1	222	GM-4P1	222
		AMIGO	1991-1994	GM-15D	222	GM-15D	222
		RODEO	1991-1994	GM-15DP	222	GM-15DP	222
		AMIGO	1998-2000	GM-5	222	GM-5	222
		RODEO	1995-1997	GM-5P	222	GM-5P	222
		D-MAX	2002-2006	ISU-3D	222	ISU-3D	222
				ISU-3DP	222	ISU-3DP	222
		I MARK	1985-1991	GM-2	221	GM-2	221
				GM-2P	222	GM-2P	222
I-290		2007-	ISU-3D	222	ISU-3D	222	
I-370		2007-	ISU-3DP	222	ISU-3DP	222	
IMPULSE		1985-1991	MIT-2I	222	MIT-2I	222	
PIAZZA		1985-1991	MIT-2IP	222	MIT-2IP	222	
TROOPER		1985-1991					
IMPULSE		1992-	GM-5	222	GM-5	222	
STYLUS		1992-	GM-5P	222	GM-5P	222	
MODELOS		1981-1984	MIT-II	222	MIT-II	222	
			MIT-IIP	222	MIT-IIP	222	
NPR		2005-2008	ISU-5		ISU-5		
TROOPER		-19-	MIT-ID	222	MIT-ID	222	
TROOPER		1982-1984	TOYO-14	223	TOYO-14	223	
	TOYO-14P		223	TOYO-14P	223		
TROOPER	1991-	GM-1P	221	GM-1P	221		
VARIOUS MODELS	-	ISU-3DP1	222	ISU-3DP1	222		
VEHY-CROSS	1998-2002	SUZU-10P	223	SUZU-10P	223		
ISUZU (USA) ©	I-350	2006-2006	KRCISU-3D	363	KRCISU-3D	363	
JAGUAR (USA) ©	S-TYPE	2000-2007	KRCFO-6	363	KRCFO-6	363	
	XJ	2004-2009					
	X-TYPE	2002-2007					



FOR: PARA:	MODEL MODELO	CCCCC	PAG.	PAG.			
JAGUAR ©	E	1970-1974	FO-D	223	UN-1FS	224	
			FO-FR	223	UN-FS	224	
				FO-FRP	223		
				WAS-2P	224		
	MAJESTIC	1989-1994	JAU-1P	223	JAU-1P	223	
	SOVEREIGN	1989-1994					
	VANDEN PLAS	1989-1994					
	XJ 6	1989-1994					
	S-TYPE	1999-2009	KRCFO-6	363	KRCFO-6	363	
	XJ	2002-2009					
	X-TYPE	2001-2009					
	VANDEN PLAS	1988-1989	FO-E-TC	223	FO-E-TC	223	
	XJ 6-40	1988-1989	FO-E-TCP	223	FO-E-TCP	223	
	XJ 6	1971-1975	FO-D	223	IN-4	223	
			FO-FR	223	UN-1FS	224	
			FO-FRP	223	UN-FS	224	
			WAS-1	224	WAS-1	224	
			WAS-2P	224	UN-FT	224	
	XJ 6	1976-1978	FO-FR	223	FO-5	223	
			WAS-1	224	WAS-1	224	
			FO-FRP	223			
			WAS-2P	224			
	XJ 6-12	1979-1987	FO-FR	223	CEM-JC	223	
FO-FRP			223				
		WAS-1	224				
		WAS-2P	224				
XJS	1975-	FO-FR	223	UN-FT	224		
		FO-FRP	223				
		WAS-2P	224				
XJS	1976-	FO-FR	223	LF-WR	223		
		FO-FRP	223				
		FO-TC	223				
		WAS-2P	224				
XJS	1976-1977	LF-WR	223	FO-TC	223		
		FO-FR	223	LF-WR	223		
XJS	1978-1987	FO-FRP	223				
		CEM-JC	223				
		FO-5	223				
		WAS-2P	224				
XJS	1988-	JAU-1P	223	JAU-1P	223		
		FO-E-TC	223				
		FO-E-TCP	223				
JDM ©	ABACA	2005-2012	SIX-3P	224	SIX-3P	224	
	ALBIZIA	2003-2012					
	ALOES	2008-2012					
	ROSKY	2012-					
JEEP ©	BRIAR WOOD	1991-1992	CHR-9	224	CHR-9	224	
	CHEROKEE	1991-1992	CHR-9P	224	CHR-9P	224	
	COMANCHE	1991-1992					
	LAREDO	1991-1992					
	LTD	1991-1992					
	WRANGLER	1991-1992					
	CHEROKEE	1993-1998	CHR-10	224	CHR-10	224	
	COMANCHE	1993-	CHR-10P	224	CHR-10P	224	
	COUNTRY	1993-					



FOR: PARA:	MODEL MODELO	CCCCC	PAG.	PAG.		
JEEP ©	G.CHEROKEE	1993-1998				
	G.WAGONEER	1993-				
	LAREDO	1993-				
	LTD	1993-				
	RENEGADE	1993-				
	SAHARA	1993-				
	SPURR	1993-				
	WAGONEER	1993-				
	WRANGLER	1993-				
	COMANCHE	1985-1990	GM-9	225		
	SCRAMBLER	1985-1990	GM-9P	225		
	WAGONEERS	1985-1990	GM-J	225		
	WRANGLER	1985-1990	GM-JP	225		
	COMMANDO D	-19-	FEM-3I	225	CL-4I	225
	COMPASS	2007-2015	KRCCHR-15	363	KRCCHR-15	363
	LIBERTY	2005-2013				
	PATRIOT	2007-2015				
	WRANGLER	2007-2015				
			PIONNER	-1991	GM-9	225
			BS-4D	224		
			GM-9P	225		
			YA-8D	225		
			GM-J	225		
			GM-JP	225		
	RENEGADE	1979-1984	GM-9	225	YA-11D	225
			GM-9P	225		
			GM-J	225		
			GM-JP	225		
	VARIOUS MODELS	-	AMM-2	224	AMM-2	224
			AMM-1	224	AMM-1	224
			CHR-14	224	CHR-14	224
			CHR-14P	225	CHR-14P	225
			HUD-1	225	HUD-1	225
			KEN-1	225	KEN-1	225
	KENWORTH ©	VARIOUS MODELS	-	KEN-1	226	KEN-1
			HUD-1	225	HUD-1	225
KIA ©	BONGO 3	2004-2014	KI-6P			
	K SERIES	2004-				
	CARNIVAL	1999-	KI-3DP	226	KI-3DP	226
	CLARENCE	2001-				
	PRIDE	1999-				
	RIO	2001-				
	SHUMA	1998-				
	SHUMA	1998-2000				
	SORENTO	1998-				
	CEED	2006-2012	KRCKI-7	363	KRCKI-7	363
	RIO	2012-2014				
	SPORTAGE	2010-2014				
	SPORTAGE	2014-2016				
	CLARUS	1998-2001	KI-3DP	226	KI-3DP	226
		KI-3P	226	KI-3P	226	
PRIDE 1.1 L	1992-1994	KI-1D	226	KI-1D	226	
PRIDE 1.3 LX	1992-1994	KI-1DP	226	KI-1DP	226	
SEPHIA (USA)	1994-1995					



FOR: PARA:	MODEL MODELO	CCCCC	PAG.	PAG.		
KIA ©	SEPHIA 1.6 I	1993-1994				
	SPORTAGE	1995-1996				
	SEPHIA (USA)	1994-	KI-1DP1	226	KI-1DP1	226
	SPORTAGE	2001-2004	KI-3P	226	KI-3P	226
	SPORTAGE USA	1996-	KI-2D	226	KI-2D	226
	VARIOUS MODELS	-	KI-12P	226	KI-12P	226
			HY-12P3	226	HY-12P3	226
			KI-11P	226	KI-11P	226
			KI-12DP	226	KI-12DP	226
	VARIOUS MODELS	2006-2018	HY-11DP1	226	HY-11DP1	226
			HY-11DP3	226	HY-11DP3	226
	VARIOUS MODELS	2006-2020	HY-11P3	226	HY-11P3	226
VARIOUS MODELS	2010-2015	HY-18PIC1	226	HY-18PIC1	226	
KIA (USA) ©	FORTE	2010-2013	KRCHY-11D	363	KRCHY-11D	363
	SOUL	2010-2011				
	SPORTAGE	2005-2008	KRCHY-4	363	KRCHY-4	363
LA FORZA ©	FORZA 5.0 V8	1989-			GIOB-3P	
LADA VAZ ©	120	1972-			IMS-5P	226
	1200	1972-	NE-3		IMS-3	226
			NE-3P		IMS-3P	226
			NE-3P1		IMS-5	226
			NE-3P2			
	1300	1972-	NE-3		IMS-3	226
	1500	1972-	NE-3P		IMS-3P	226
	1600	1972-	NE-3P1		IMS-5	226
	2101	1972-	NE-3P2		IMS-5P	226
	21011	1972-				
	2102	1972-				
	2103	1972-				
	2104	1972-				
	21043	1972-				
	2105	1972-				
	2106	1972-				
	21061	1972-				
	2107	1972-				
	NIVA	-19-				
RIVA	-19-					
3110	-19-	LA-3D		LA-2		
		LA-3DP		LA-2P		
		LA-4D				
		LA-4DP				
4x4	-19-	LA-1D		LA-1D		
4x4 G.LARGE	-19-	LA-1DP		LA-1DP		
KAMA	1984-	LA-2		LA-2		
SAGONA	-19-	LA-2P		LA-2P		
		LA-3D		LA-3D		
		LA-3DP		LA-3DP		
CARLOTA	1991-	LA-1D		LA-1D		
SAMARA	1991-1992	LA-1DP		LA-1DP		
NIVA 1.6	1992-	NE-3		IMS-3	226	
		NE-3P		IMS-3P	226	
		NE-3P1				



Automóvil. Camioneta
Automobila. Kamioneta
Voiture. Camionnette

Auto. Kleintransporter
Automóvil. Camioneta
Automóvil. Camioneta

FOR: PARA:	MODEL MODELO			PAG.		PAG.
LADA VAZ ®				NE-3P2		
	SAMARA	1992-		LA-3D	LA-2	
				LA-3DP	LA-2P	
VARIOUS MODELS	-		NE-3D	NE-3D		
LAMBORGHINI ®	COUNTACH	-19-		AF-7I	227	IMS-3 228
	JALPA	-19-		AF-7IP	228	IMS-3P 228
	URRACO	-19-		AF-7IP1	228	IMS-5 228
						IMS-5P 228
	DIABLO COU.	-19-		AF-7I	227	IMS-3 228
				AF-5D	227	AF-5D 227
	DIABLO ROA.	-19-		AF-7IP	228	IMS-3P 228
				AF-7IP1	228	IMS-5 228
						IMS-5P 228
				AF-5I	227	AF-5I 227
				AF-6D	227	AF-6D 227
				AF-6I	227	AF-6I 227
	ESPADA	-19-		AF-7I	227	AF-5I 227
				AF-6D	227	AF-6D 227
				AF-7IP	228	AF-6I 227
				AF-7IP1	228	
	MIURA	-19-		BH-1	228	AF-4D 227
				BH-1P	228	AF-4I 227
						AF-5D 227
					AF-5I 227	
					AF-6D 227	
					AF-6I 227	
LANCIA ®	2000	-1972		GIOB-1D	229	GIOB-2I 229
	APPIA	-1972		GIOB-1DP	229	GIOB-2IP 229
	FLAVIA	-1972				
	FULVIA	-1972				
	2000	1972-		GIOB-1D	229	GIOB-2I 229
	FULVIA	1972-		GIOB-1DP	229	GIOB-2IP 229
				SIP-3	230	
	BETA	1972-1982		AF-7I	228	GIOB-3P
	DELTA	1979-1982		AF-7IP	228	
	GAMMA	1972-1982		FI-9I	229	
				FI-9IP	229	
	BETA	1975-1980		AF-7I	228	AF-10 228
	MONTECARLO	1975-1980		AF-7IP	228	AF-11 228
						AF-12 228
	DEDRA	1989-1995		FI-13	229	FI-13 229
	DEDRA S.W.	1994-		FI-13P	229	FI-13P 229
	DELTA	1993-1995		FI-14P	229	FI-14P 229
	DELTA	1983-		FI-3D	228	FI-6IP1 229
				FI-3DP	228	FI-6IP2 229
			FI-3DP3	228	FI-6IP4 228	
			FI-6I	229	GIOB-3P	
			FI-6IP	229		
			FI-6IP1	229		
			FI-6IP2	229		
			FI-6IP3	229		
			FI-6IP4	228		
DELTA	1984-1992		FI-11	229	GIOB-3P	
PRISMA	1984-1989		FI-11P	229		
LANCIA Z	1994-		SIX-3P1	230	SIX-3P1 230	



FOR: PARA:	MODEL MODELO			PAG.		PAG.	
LANCIA ®	Z 2000	1994-					
	PHEDRA	2006-2010		KRCHU-HCA	363	KRCHU-HCA 363	
	THEMA	1984-		FI-10	228	FI-10 228	
				FI-10P	228	FI-10P 228	
				FI-11	229	FI-11 229	
				FI-11P	229	FI-11P 229	
				FI-11P	229	FI-11P 229	
	TREVI	1980-		FI-9I	229	GIOB-3P	
				FI-9IP	229		
	VARIOUS MODELS	-		FI-16C1	356	FI-16C1 356	
VARIOUS MODELS		2000-		FI-16C3	356	FI-16C3 356	
				FI-16P1	229		
	LAND-RANGE ROVER ®	90 2500	1988-1991		IMS-7	230	AB-6I 230
		90 3500	1988-1991		IMS-7P	230	
		110 2500	1985-1987				
		SANTANA	1987-1991				
		109	1982-1983		LF-RO	230	UN-FS 231
		88	1982-1983		LF-ROP	230	
		109	1984-		LF-RO	230	UN-FS 231
					UN-FT	231	UN-FT 231
110		1984-1985		LF-ROP	230		
88		1984-					
109		1985-1987		LF-RO	230	AB-6I 230	
				UN-FT	231	UN-FT 231	
110		1986-1987		LF-ROP	230		
88		1985-1987					
SANTANA		1985-1987					
110		1985-1986		LF-RO	230	LF-RO 230	
90		1985-1986		LF-ROP	230	LF-ROP 230	
110		1987-1991		LF-RO	230	UN-FT 231	
90		1987-1991		LF-ROP	230		
DEFENDER	1990-						
110 3500	1985-1987		IMS-7	230			
			IMS-7P	230			
			AB-6I	230			
DISCOVERY	1989-1993		NE-11	230	NE-11 230		
			NE-11P1	230	NE-11P1 230		
			NE-11P2	230	NE-11P2 230		
DISCOVERY	1994-1997		NE-52P	231	NE-52P 231		
MODELOS	1970-1972		UN-FS	231	UN-FP 231		
MODELOS	1973-1981		UN-FS	231	UN-FS 231		
R.ROVER	-1983		UN-NH	231	UN-NH 231		
			UN-NHP		UN-NHP		
			UN-FS	231	UN-FS 231		
R.ROVER	1984-1988		NE-11	230	NE-11 230		
			NE-11P	230	NE-11P 230		
			NE-11P1	230	NE-11P1 230		
			NE-11P2	230	NE-11P2 230		
			NE-24	230	NE-24 230		
			NE-24P	230	NE-24P 230		
			NE-24P1	230			
			UN-FS	231	UN-FS 231		
			UN-FT	231	UN-FT 231		
R.ROVER	1989-1997		NE-11	230	NE-11 230		
			NE-11P	230	NE-11P 230		



FOR: PARA:	MODEL MODELO			PAG.		PAG.
LEXUS (TOYOTA) (USA) ®	ES330	2004-2006		KRCTOYO-30	363	KRCTOYO-30 363
	RX330	2003-2008				
	RX350	2003-2008				
	RX400H	2005-2008				
LEXUS (TOYOTA) ®	250 ES	1989-		TOYO-18P	231	TOYO-18P 231
	300 ES	1989-				
	400 LS	1989-				
	COUPE 300 SC	1991-				
	COUPE 400 SC	1991-				
	GS300	2000-2004		KRCTOYO-30	363	KRCTOYO-30 363
	GS430	2001-2005				
	IS200	1999-2005				
	IS300	2001-2005				
	RX300	1999-2003				
VARIOUS MODELS	-		TOYO-30P1	231	TOYO-30P1 231	
LIGIER ®	IXO	2010-		SIX-3P	231	SIX-3P 231
	JS	-19-				
	NOVA	1999-2004				
	OPTIMAX	2010-				
	X-T00	2006-2012				
LINCOLN ®	AVIATOR	2003-2005		KRCFO-30D	364	KRCFO-30D 364
	LS	2003-2006				
	MARK LT	2006-2008				
	MKS	2009-2009				
	MKX	2007-2010				
	MKZ	2007-2010				
	NAVIGATOR	2002-2010				
	NAVIGATOR	2011-2012				
	TOWN CAR	2003-2011				
	ZEPHYR	2006-2006				
	CONTINENTAL	1967-1984		FO-2	231	FO-1 231
	CONTINENTAL	1985-1991		FO-20D	231	FO-20D 231
				FO-1	231	FO-1 231
	CONTINENTAL	1991-1998		FO-11D	231	FO-11D 231
				FO-1	231	FO-1 231
LS	2000-2002		KRCFO-15D	364	KRCFO-15D 364	
NAVIGATOR	1998-2002					
TOWN CAR	1998-2002					
MARK SERIES	1985-1991		FO-11D	231	FO-11D 231	
			FO-1	231	FO-1 231	
			FO-20D	231	FO-20D 231	
LOTUS ®	ECLAT	-19-		TOYO-K1	232	TOYO-K1 232
	EXCEL SE	-19-		TOYO-K1P	232	TOYO-K1P 232
	ELAN SE	1991-		OP-D	232	OP-D 232
				GM-12	232	GM-12 232
			GM-12P	232	GM-12P 232	
			OP-DP	232	OP-DP 232	
			GM-H	232	GM-H 232	
			GM-HP	232	GM-HP 232	
ESPRIT 2.2	-19-		LF-RO	232	UN-FT 233	
			WAS-6	233	WAS-6 233	



FOR: PARA:	MODEL MODELO			PAG.		PAG.
LOTUS ®	ESPRIT TURBO	-19-		LF-ROP	232	
				WAS-6P		WAS-6P
	ESPRIT COUPE	1991-		LF-RO	232	UN-FT 233
				LF-ROP	232	
	VARIOUS MODELS	-		FO-FR	231	UN-FS 232
			FO-FRP	232	UN-FT 233	
			LF-RO	232		
			LF-ROP	232		
MACK ®	VARIOUS MODELS	-		KEN-1	233	KEN-1 233
				HUD-1	233	HUD-1 233
MAHINDRA ®	VARIOUS MODELS	-		TAT-2DP	233	TAT-2DP 233
MARUTI ®	800	1991-1992		SUZU-7	233	SUZU-7 233
	800 LUXE	1991-1992		SUZU-7P	233	SUZU-7P 233
	800 S.LUXE	1991-1992				
	VARIOUS MODELS	-		MAR-1P	233	MAR-1P 233
MASERATI ®	BITURBO	1981-		LF-RO	234	AF-10 233
				AF-5D	233	AF-5D 233
	GHIBLI	1986-		LF-ROP	234	AF-11 233
				AF-6D	233	AF-6D 233
	KARIF	1986-				AF-12 233
	SHAMAL	1986-				
	SPYDER	1986-				
	BORA	1971-1976		AF-7I	233	RO-5D 234
				GIOB-2I	234	GIOB-2I 234
				AF-7IP	233	
			AF-7IP1	233		
			GIOB-2IP	234	GIOB-2IP 234	
GHIBLI 5000	-19-				IMS-3 234	
					IMS-3P 234	
INDY 4900 A.	1969-		AF-7I	233	GIOB-2I 234	
			AF-7IP	233	GIOB-2IP 234	
			AF-7IP1	233	RO-5D 234	
KHAMSIN	1972-		AF-7I	233	IMS-3 234	
			AF-7IP	233	IMS-3P 234	
			AF-7IP1	233	IMS-5 234	
					IMS-5P 234	



Automóvil. Camioneta
Automobila. Kamioneta
Voiture. Camionnette

Auto. Kleintransporter
Automóvil. Camioneta
Automóvil. Camioneta

FOR: PARA:	MODEL MODELO			PAG.		PAG.
MAZDA®	MX6			1990-1992		
	323 S.W.		MAZ-2D	234	MAZ-2D	234
	929 S.W.		MAZ-2DP	235	MAZ-2DP	235
	323			1977-1982		
	626			1978-1982		
	929			1980-1982		
	323 S.W.		MAZ-3D	235	MAZ-3D	235
	626 S.W.		MAZ-6DP	235	MAZ-6DP	235
	929 S.W.			1982-		
	121			1988-1990		
	323			1983-1989		
	626			1987-1991		
	727			1987-1991		
	COSMO			1984-1986		
	MX6			1986-1989		
	RX7			1987-1991		
	616 CAP.	-1970	DAT-3I	234	MAZ-2D	234
	616 SNA	-1970			MAZ-2DP	235
	RX2 CAPPE.	1970-1971				
	616 CAPE.	1971-1973	DAT-11D	234	MAZ-2D	234
	618	1971-1973	DAT-11DP		MAZ-2DP	235
	RX2 CAPPE.	1974-1977	WAS-2P	236		
	RX3	1974-1977				
	626 GL	1981-	CHR-3	234	MAZ-2D	234
			NE-22P2	236	MAZ-2DP	235
	626 S.W.	1993-1996	MAZ-5D	235	MAZ-5D	235
	RX7	1991-	MAZ-5DP	235	MAZ-5DP	235
	818 1.3	-1971	DAT-3I	234	MAZ-1I	234
	818 1.5	-1971				
	1800	1971-1972				
	929 GLX	1987-	MAZ-3D	235	MAZ-3D	235
			MAZ-3DP	235	MAZ-3DP	235
			MAZ-6DP	235	MAZ-6DP	235
	1200	1970-1972	DAT-11D	234	MAZ-1I	234
	1800	1970-1971	DAT-11DP			
			WAS-2P	236		
	121	1991-1992	MAZ-5D	235	MAZ-5D	235
			MAZ-5DP	235	MAZ-5DP	235
			MAZ-7D	235	MAZ-7D	235
			MAZ-7DP	235	MAZ-7DP	235
	121	1993-1994	MAZ-13D	236	MAZ-13D	236
	323	1992-1994	MAZ-13DP	236	MAZ-13DP	236
	MX3	1992-1995	MAZ-13DPI	236	MAZ-13DPI	236
	MX5	1992-1995	MAZ-7D	235	MAZ-7D	235
	RX7	1992-	MAZ-7DP	235	MAZ-7DP	235
	XEDOS	1992-1996				
	121	1995-	FO-6P	234	FO-6P	234
	1600	1972-	DAT-3I	234	MAZ-1D	234
	R 100	1970-1971				
	2	2002-2006	KRCMAZ-11D	364	KRCMAZ-11D	364
	2	2007-2010				
	2	2007-2014				
	3	2004-2008				
	3	2008-2011				
	3	2012-2013				
	6	2002-2004				
	6	2004-2008				

FOR: PARA:	MODEL MODELO			PAG.		PAG.
MAZDA®	6			2008-2012		
	CX7			2006-2012		
	CX9			2007-2009		
	M5			2005-2010		
	M5			2010-2015		
	MX-5			2005-2012		
	323	-19-	MAZ-4P	235	MAZ-4P	235
	323	1982-1983	MAZ-3D	235	MAZ-3D	235
			MAZ-3DP	235	MAZ-3DP	235
			MAZ-3I	235	MAZ-3I	235
			MAZ-3IP	235	MAZ-3IP	235
	323	1989-1992	MAZ-3D	235	MAZ-3D	235
			MAZ-7D	235	MAZ-7D	235
			MAZ-7DP	235	MAZ-7DP	235
	323	1995-			MAZ-7DPI	235
	MX3	1995-				
	MX5	1995-				
	626	1982-1987	MAZ-3D	235	MAZ-3D	235
	929	1982-1986	MAZ-3DP	235	MAZ-3DP	235
			MAZ-3I	235	MAZ-3I	235
			MAZ-6DP	235	MAZ-6DP	235
			MAZ-6P	235	MAZ-6P	235
	626	1991-	MAZ-7D	235	MAZ-7D	235
			MAZ-7DP	235	MAZ-7DP	235
			MAZ-7DPI	235	MAZ-7DPI	235
	626	1991-1995	MAZ-13D	236	MAZ-13D	236
	MX6	1992-1995	MAZ-13DP	236	MAZ-13DP	236
			MAZ-13DPI	236	MAZ-13DPI	236
	626	1995-1997			MAZ-13D	236
	MX6	1995-1997			MAZ-13DP	236
	XEDOS 6	1995-1997			MAZ-13DPI	236
	808	1971-1977	DAT-11D	234	MAZ-2D	234
	818	1971-1977	DAT-11DP		MAZ-2DP	235
			WAS-2P	236	MAZ-2I	234
					MAZ-2IP	235
	929	1973-1980	DAT-11D	234	MAZ-2D	234
			DAT-11DP		MAZ-2DP	235
			WAS-2P	236	MAZ-2I	234
					MAZ-2IP	235
	ARTIS	-19-	MAZ-21DPI	236	MAZ-21DPI	236
	B 1800	1970-1971	MAZ-1I	234	MAZ-1I	234
	BT50	2011-2015	KRCFO-24	364	KRCFO-24	364
	COSMO	1975-1979	MAZ-16	236	MAZ-16	236
	COSMO	1980-	MAZ-3D	235	MAZ-3D	235
			MAZ-3DP	235	MAZ-3DP	235
	COSMO	1982-1983	MAZ-3D	235	MAZ-3D	235
			MAZ-3DP	235	MAZ-3DP	235
			MAZ-3I	235	MAZ-3I	235
			MAZ-6P	235	MAZ-6P	235
	E 1600	1986-	MAZ-2D	234	MAZ-2D	234
			MAZ-2DP	235	MAZ-2DP	235
			MAZ-2I	234	MAZ-2I	234
			MAZ-2IP	235	MAZ-2IP	235
			MAZ-3D	235	MAZ-3D	235
			MAZ-3DP	235	MAZ-3DP	235
			MAZ-3I	235	MAZ-3I	235
			MAZ-3IP	235	MAZ-3IP	235

FOR: PARA:	MODEL MODELO			PAG.		PAG.
MAZDA®	EUNOS 800	1993-	TOYO-18P	236	TOYO-18P	236
	XEDOS 9	1993-1996				
	GLC 323	1983-1989	MAZ-3D	235	MAZ-3D	235
			MAZ-3DP	235	MAZ-3DP	235
	MIATA	1989-1992	MAZ-3D	235	MAZ-3D	235
			MAZ-7D	235	MAZ-7D	235
	MX5	1989-1992	MAZ-7D	235	MAZ-7D	235
			MAZ-7DP	235	MAZ-7DP	235
			MAZ-7DPI	235	MAZ-7DPI	235
	MPV	1989-	MAZ-7D	235	MAZ-7D	235
			MAZ-7DP	235	MAZ-7DP	235
	MX3	1991-1992	MAZ-7D	235	MAZ-7D	235
			MAZ-7DP	235	MAZ-7DP	235
			MAZ-7DPI	235	MAZ-7DPI	235
	NAVAJO	1991-	MAZ-8D	235	MAZ-8D	235
			MAZ-8DP	235	MAZ-8DP	235
	R 100	1972-	DAT-11D	234	MAZ-1D	234
	R 1200	1972-	DAT-11DP			
			WAS-2P	236		
	RX2	1972-1973	DAT-11D	234	MAZ-2I	234
			DAT-11DP		MAZ-2IP	235
			WAS-2P	236		
	RX4 LUCE	1972-1978	MAZ-2D	234	MAZ-2D	234
	RX5 COSMO	1972-1978	MAZ-2DP	235	MAZ-2DP	235
	RX7 COUPE	1972-1978	MAZ-2I	234	MAZ-2I	234
			MAZ-2IP	235	MAZ-2IP	235
	RX7	1983-1986	MAZ-3D	235	MAZ-3D	235
			MAZ-3DP	235	MAZ-3DP	235
			MAZ-6DP	235	MAZ-6DP	235
	VARIOUS MODELS	-	MAZ-ID	234	MAZ-2D	234
			MAZ-1I	234	MAZ-2DP	235
					MAZ-2I	234
					MAZ-2IP	235
			DAT-1I	234	DAT-1I	234
			DAT-11P	234	DAT-11P	234
			MAZ-15D	236	MAZ-15D	236
			MAZ-6	235	MAZ-6	235
			MAZ-11D	235	MAZ-11D	235
			MAZ-11DPI	236	MAZ-11DPI	236
			MAZ-4	235	MAZ-4	235
			MAZ-14D	236	MAZ-14D	236
MAZDA (USA)®	2	2011-2013	KRCMAZ-11D	364	KRCMAZ-11D	364
	3	2003-2005				
	3	2007-2008				
	3	2010-2013				
	6	2003-2005				
	6	2010-2012				
	CX7	2006-2008				
	CX7	2009-2012				
	CX9	2009-2013				
	M5	2005-2010				

FOR: PARA:	MODEL MODELO			PAG.		PAG.
MAZDA (USA)®	M5			2010-2015		
	MX-5			2005-2012		
	MX-5			2009-2015		
	RX8			2004-2008		
	B-SERIES	1999-2000	KRCFO-15D	364	KRCFO-15D	364
	B-SERIES	2001-2009				
	TRIBUTE	2001-2004				
	TRIBUTE	2005-2007				
	TRIBUTE	2008-2011				
MERCEDES®	180C	1993-	ME-7P	237	ME-7P	237
	200C	1993-	ME-8P	237	ME-8P	237
	220C	1993-				
	280C	1993-				
	300C	1993-				
	190 ALARM	1986-1992	ME-10P	237	ME-10P	237
			ME-11P	237	ME-11P	237
			ME-12P	237	ME-12P	237
	206D	-19-	ME-VA	238	ME-VA	238
	306D	-19-				
	207D	-1992	ME-HM	237	ME-HM	237
	207F	-1992	ME-HMP	237	ME-HMP	237
	207K	-1992				
	208D	-1992				
	209D	-1992				
	240D	1973-1976	ME-HD	237	ME-HD	237
	200	1973-1974	ME-HDP	237	ME-HDP	237
	220	1973-1974	ME-HF	237	ME-HF	237
	230	1973-1974	ME-HFP	237	ME-HFP	237
	250	1973-1977	ME-HM	237	ME-HM	237
	280	1973-1974	ME-HMP	237	ME-HMP	237
	350	1973-	ME-HZ	237	ME-HZ	237
	380	1973-1977	ME-HZP	237	ME-HZP	237
	450	1973-1979				
	240D	1976-	ME-HU	238	ME-HU	238
	300D	1976-	ME-HUP	238	ME-HUP	238
	200	1976-1977	ME-NU	238	ME-NU	238
			ME-NUP	238	ME-NUP	238
	307D	-1992	ME-HM	237	ME-HM	237
	308D	1992-	ME-HMP	237	ME-HMP	237
	L 508	-1991				
	L 608	-1991				
	LN 914	-1991				
	MB 308DT	-1991				
	MB 408DT	-1991				

Automóvil. Camioneta
Automobila. Kamioneta
Voiture. Camionnette

Auto. Kleintransporter
Automóvil. Camioneta
Automóvil. Camioneta

FOR: PARA:	MODEL MODELO			PAG.		PAG.
MERCEDES @	420			1984-		
	450			1979-		
	500			1979-		
	560			1984-		
	1117		ME-HMP	237	ME-HMP	237
	1300			1996-		
	1500			1996-		
	711			1996-		
	814			1996-		
	817			1996-		
	917			1996-		
	SPRINTER			1996-		
	VARIO			1996-		
	190		ME-4P	237	ME-4P	237
			ME-5P	237	ME-5P	237
	200		ME-HD	237	ME-HD	237
	220		ME-HDP	237	ME-HDP	237
	230		ME-HZ	237	ME-HZ	237
	240		ME-HZP	237	ME-HZP	237
	280			1974-1979		
	200		ME-HF	237	ME-HF	237
			ME-HFP	237	ME-HFP	237
			ME-HM	237	ME-HM	237
			ME-HMP	237	ME-HMP	237
	200		ME-HU	238	ME-HU	238
	230		ME-HUP	238	ME-HUP	238
	240		ME-HY	238	ME-HY	238
	250		ME-HYP	238	ME-HYP	238
	300		ME-NU	238	ME-NU	238
	380		ME-NUP	238	ME-NUP	238
			ME-NY	238	ME-NY	238
			ME-NYP	238	ME-NYP	238
	220		ME-HF	237	ME-HF	237
	230		ME-HFP	237	ME-HFP	237
	250		ME-HZ	237	ME-HZ	237
	280		ME-HZP	237	ME-HZP	237
	300			1972		
	350			1972		
	7200			1972		
	230		ME-HF	237	ME-HF	237
	240		ME-HFP	237	ME-HFP	237
	280		ME-HM	237	ME-HM	237
	300		ME-HMP	237	ME-HMP	237
	TODOT. 4WD		ME-HZ	237	ME-HZ	237
			ME-HZP	237	ME-HZP	237
	400		ME-2P	237	ME-2P	237
	600		ME-3P	237	ME-3P	237
	MB 100D		ME-1	236	ME-1	236
			ME-1P	237	ME-1P	237
	VARIOUS MODELS		NE-61D	238		
			NE-62	238		
			ME-L	238	BOM-2	236
					BOM-2D	236
					ME-L	238
	VITO		ME-HMP	237	ME-HMP	237
			ME-HZ	237	ME-HZ	237
			ME-HZP	237	ME-HZP	237

FOR: PARA:	MODEL MODELO			PAG.		PAG.
MERCEDES @	VITO		ME-HMLP	237	ME-HMLP	237
MERCURY @	CAPRI		FO-D	239	FO-XL	239
	CAPRI		FO-E-TC	239	FO-E-TC	239
	CAPRI		FO-E-TCP	239	FO-E-TCP	239
			FO-TC	239	FO-TC	239
	CAPRI		FO-2	238	FO-2	238
			FO-1	238	FO-1	238
	CAPRI		FO-14DP	239	FO-14DP	239
			FO-7P	238	FO-7P	238
	COUGAR		FO-2	238	FO-1	238
	MARQUIS			1967-1989		
	COUGAR		FO-11D	238	FO-11D	238
	MARQUIS		FO-20D	239	FO-20D	239
	TOPAZ			1990-		
	COUGAR		KRCFO-16	364	KRCFO-16	364
	MYSTIQUE			1995-2000		
	G.MARQUIS		FO-8D	238	FO-8D	238
	MERCURY		FO-8DPI	238	FO-8DPI	238
	SABLE			1993-1996		
	GRAND MARQUIS		KRCFO-30D	364	KRCFO-30D	364
	MARAUDER			2003-2005		
	MARINER			2005-2006		
	MARINER			2007-2010		
	MARINER			2011-2011		
	MILAN			2006-2006		
	MILAN			2007-2011		
	MONTEGO			2005-2007		
	MONTEREY			2004-2007		
	MOUNTAINEER			2002-2010		
	SABLE LS, LE, SHO			2000-2006		
	SABLE LS, LE, SHO			2008-2009		
	MERCURY		FO-2	238	FO-2	238
	MOUNTAINEER		KRCFO-15D	364	KRCFO-15D	364
	SABLE			1993-1997		
	SABLE LS, LE, SHO			1998-1999		
	MYSTIQUE		FO-8D	238	FO-8D	238
	SABLE GS/LS		FO-15D	239	FO-15D	239
			FO-15DP	239	FO-15DP	239
	TOPAZ		FO-2	238	FO-1	238
	TRACER		FO-14DP	239	FO-14DP	239
			FO-7P	238	FO-7P	238
	TRACER		FO-8D	238	FO-8D	238
			FO-8DP	238	FO-8DP	238
			FO-8DPI	238	FO-8DPI	238
MG @	MG		UN-NH	240	UN-FS	240
			IN-4	239	IN-4	239
	MGB		UN-NHP		UN-FS	240
	MG		NE-1	239	UN-FS	240
			NE-1P	239		
	MG		NE-10	239	UN-FS	240
			NE-10P	239	UN-FT	240
	MGB		NE-1	239	UN-FS	240

FOR: PARA:	MODEL MODELO			PAG.		PAG.
MG @			NE-1P	239		
	MGB GT		UN-NH	240	UN-FS	240
			UN-NHP			
	MGF		NE-10P	239	NE-10P	239
	VARIOUS MODELS		UN-FP	240	UN-FP	240
			UN-FS	240	UN-FS	240
MICROCAR @	FAMILY		SIX-3P	240	SIX-3P	240
	M.GO			2009-		
	NEWSTREET			2008-		
	PRATIC			2008-		
	VIRGO			2008-		
MITSUBISHI @	3000 GT/R/SL		MIT-12	241	MIT-12	241
	BRAVO		MIT-7	241	MIT-7	241
	CHARIOT		MIT-7P	241	MIT-7P	241
	COLT			1987-1993		
	DIAMANTE			1992-		
	ECLIPSE			1987-		
	ETERNA			1989-		
	EXPO			-19-		
	GALANT			1987-1996		
	L 200			1987-		
	L 300			1987-		
	LANCER			1987-1996		
	MINICAB			1987-		
	MIRAGE			1987-1993		
	MONTERO			1992-1996		
	MX SUPER A.R			-19-		
	NIMBUS			1987-		
	PAJERO			1992-1996		
	S.RUNNER			1992-1998		
	SHOGUN			-19-		
	SPACE WAGON			1985-		
	CANTER		MIT-15P	241	MIT-15P	241
	CELESTE		MIT-II	240	MIT-II	240
	COLT		MIT-IIP	240	MIT-IIP	240
	GALANT			1972-1980		
	LAMBDA			1972-1980		
	LANCER			1972-1980		
	MINICA			1972-1980		
	STARION			1972-1980		
	COLT		MIT-2I	240	MIT-2I	240
	CORDIA		MIT-2IP	240	MIT-2IP	240
	DEBONAIR			1981-1984		
	ETERNA			1981-1983		
	GALANT			1981-1983		
	L 300			-1983		
	L 300 VAN			1981-1984		
	LANCER			1981-1983		
	MINICA			1981-1983		
	MONTERO			1981-1992		
	PAJERO			1981-1992		
	SAPORO			1981-1984		
	SHOGUN			1981-1984		
	SIGMA			1981-1984		
	SPACE WAGON			1981-1983		

FOR: PARA:	MODEL MODELO			PAG.		PAG.
MITSUBISHI @	STARION			1981-1983		
	VISTA			-1993		
	COLT		MIT-3	240	MIT-3	240
	DEBONAIR		MIT-3P	240	MIT-3P	240
	ETERNA		MIT-4	241	MIT-4	241
	GALANT		MIT-4P	241	MIT-4P	241
	L 300			1983-1987		
	LANCER			1983-1987		
	MINICA			1983-1987		
	ORCHID			1983-1985		
	SPACE WAGON			1983-1985		
	STARION			1983-1985		
	TREDIA			1983-1985		
	COLT		MIT-13D	241	MIT-13D	241
	MIRAGE		MIT-14D	241	MIT-14D	241
			MIT-8D	241	MIT-8D	241
			MIT-8DP	241	MIT-8DP	241
	COLT		KRCMIT-8D	364	KRCMIT-8D	364
	GRANDIS			2003-2011		
	LANCER			2006-2010		
	GALANT		MIT-1D	240	MIT-1D	240
	LANCER			-19-		
	MONTERO			-19-		
	INTERCOOLER		CHR-17	240	CHR-17	240
			MIT-12	241	MIT-12	241
			MIT-7	241	MIT-7	241
			MIT-7P	241	MIT-7P	241
	L 400		MIT-7P	241	MIT-7P	241
	L200		KRCMIT-12	364	KRCMIT-12	364
	MONTERO			2006-2014		
	MONTERO SPORT			2008-2014		
	PAJERO			2006-2011		
	PAJERO			2006-2014		
	PAJERO			2008-2014		
	PICK UP		MIT-1D	240	MIT-1D	240
	PRECIS		HY-3D	240	HY-3D	240
			HY-			

Automóvil. Camioneta
Automobila. Kamioneta
Voiture. Camionnette

Auto. Kleintransporter
Automóvil. Camioneta
Automóvil. Camioneta

FOR: PARA:	MODEL MODELO	CCCCC	PAG.	PAG.
MITSUBISHI (USA) ®	DIAMANTE	2004-2004		
	MONTERO	2001-2006		
	MONTERO SPORT	2000-2000		
	MONTERO SPORT	2001-2004		
	ECLIPSEEXPORTACION A CHINA	1999-2000	KRCMIT-18 365	KRCMIT-18 365
	ECLIPSEEXPORTACION A CHINA	2001-2001		
	ECLIPSEEXPORTACION A CHINA	2002-2005		
	ENDEAVOR	2004-2005		
	ENDEAVOR	2006-2006		
	GALANT	2000-2001		
	GALANT	2002-2003		
	GALANT	2004-2005		
	LANCER EVO 8 EUROPE	2003-2006	KRCMIT-8D 365	KRCMIT-8D 365
	OUTLANDER	2003-2006		
MOSKVITCH ®	2135	-19-	NE-3 242	MOS-1 242
	2136	-19-	NE-3P 242	VOL-3 242
	2137	-19-	NE-3P1 242	
	2138	-19-	NE-3P2 242	
	2140	-19-		
	408	-19-		
	412	-19-		
	426	-19-		
	427	-19-		
	2141 ALEKO	-19-	LA-3D 241	LA-3D 241
			LA-3DP 242	LA-3DP 242
	VARIOUS MODELS	-	NE-3D 242	NE-3D 242
NISSAN ®	200 SX	-1983	DAT-12 244	DAT-12 244
	240 Z	-1983	DAT-6 243	DAT-6 243
	280 Z	-1983	DAT-6P 243	DAT-6P 243
	300 L	-1983	DAT-7 243	DAT-7 243
	300 ZX	-1983	DAT-7P 243	DAT-7P 243
	AUSTER	-1983		
	AXXESS	-1983		
	BLUEBIRD	-1983		
	CEDRIC	-1983		
	CHERRY	-1983		
	EXA	-1983		
	FAIRLADY	-1983		
	GAZELLE	-1983		
	GLORIA	-1983		
	LANGLEY	-1983		
	LAUREL	-1983		
	LEOPARD	-1983		
	LIBERTA VIL.	-1983		
	MARCH	-1983		
	MAXIMA	-1983		
	MICRA	-1983		
	PAO	-1983		
	PINTARA	-1983		
	PRAIRE	-1983		
	PRESIDENT	-1983		
	PULSAR	-1983		



FOR: PARA:	MODEL MODELO	CCCCC	PAG.	PAG.
NISSAN ®	SENTRA	-1983		
	SILVIA	-1983		
	SKYLINE	-1983		
	STANZA	-1983		
	SUNNY	1983-1989		
	TULIP	-1983		
	VANETTE	-1983		
	VIOLET	-1983		
	240 Z	1969-1973	DAT-5D 242	DAT-1D 242
	280 Z	1969-1973		DAT-1DP 242
	BLUEBIRD	1977-1979		
	CHERRY	1977-1979		
	SENTRA	1977-1979		
	SKYLINE	1977-1979		
	SUNNY	1977-1979		
	VIOLET	1977-1979		
	240 Z	1974-1983	DAT-5D 242	DAT-2D 242
	260 Z	1974-1983		DAT-2DP 242
	280 Z	1974-1983		DAT-2I 242
	280 ZX ST.W	1974-1983		DAT-2IP 242
	1200 DE LUXE	-1971		DAT-4I 242
	1200 VAN	-1971		
	1200 DE LUXE	1971-1972	DAT-8 243	DAT-7 243
			DAT-8P 243	DAT-7P 243
	BLUEBIRD	1970-1976	DAT-5D 242	DAT-8 243
	CHERRY	1970-1976		DAT-8I 243
	SENTRA	1970-1976		DAT-8IP 243
	SKYLINE	1970-1976		DAT-8IP1 243
	SUNNY	1970-1976		DAT-8P 243
	VIOLET	1970-1976		
	BLUEBIRD	1976-1979	DAT-1D 242	DAT-1D 242
			DAT-1DP 242	DAT-1DP 242
			DAT-1I 242	DAT-1I 242
			DAT-1IP 242	DAT-1IP 242
	BLUEBIRD	1980-1982	DAT-9D 243	DAT-9D 243
			DAT-9DP 243	DAT-9DP 243
			DAT-9I 243	DAT-9I 243
			DAT-9IP 243	DAT-9IP 243
	CEDRIC	1995-1997	DAT-15 244	DAT-15 244
	GLORIA	1995-1997	DAT-15P 244	DAT-15P 244
	PATHFINDER	1996-1997	DAT-16 244	DAT-16 244
	CHERRY	1980-1982	NE-1I 245	DAT-1D 242
			NE-1IP 245	DAT-1DP 242
				DAT-1I 242
				DAT-1IP 242
	FLORIDA	1989-1991	DAT-6 243	DAT-6 243
	PATROL 4x4	1986-	DAT-6P 243	DAT-6P 243
	SUNNY	1989-1991		
	TERRANO	1989-1995		
	TRADE	1989-		
	JUKE	2010-2014	KRCDAT-15 365	KRCDAT-15 365
	KING CAB	2008-2011		
	MICRA	2010-2014		
	MAXIMA	1980-1982	DAT-2D 242	DAT-2D 242
			DAT-2DP 242	DAT-2DP 242
			DAT-2I 242	DAT-2I 242
			DAT-2IP 242	DAT-2IP 242



FOR: PARA:	MODEL MODELO	CCCCC	PAG.	PAG.
NISSAN ®	MAXIMA	1991-1995	DAT-10 243	DAT-7 243
			DAT-10P 243	
	MICRA	1993-1995	DAT-10 243	DAT-10 243
	PRIMERA	1991-1995	DAT-10P 243	DAT-10P 243
	TERRANO	1995-		
	TERRANO II	1993-1995		
	MICRA	2002-2010	DAT-15C2 356	DAT-15C2 356
	NOTE	2005-2012		
	PATHFINDER	2005-2012		
	QASHQAI	2007-2013		
	X-TRAIL	2004-2013		
	PATHFINDER	1991-	DAT-12 244	DAT-12 244
	SENTRA	1991-		
	PATROL 4 WD	-1985	DAT-8 243	DAT-8 243
			DAT-8P 243	DAT-8P 243
	QUEST	1993-	FO-8D 244	FO-8D 244
			FO-8DP 244	FO-8DP 244
			FO-8DP1 245	FO-8DP1 245
	QUEST	1993-1994	DAT-19 244	DAT-19 244
			DAT-19P 244	DAT-19P 244
	QUEST	1996-	DAT-20 244	DAT-20 244
			DAT-20P 244	DAT-20P 244
	SERENA	1993-1996	DAT-6 243	DAT-6 243
			DAT-6P1 243	DAT-6P1 243
	URVAN	-1994	DAT-12 244	DAT-12 244
				DAT-1D 242
				DAT-1DP 242
	VANETTE	1983-1996	DAT-12 244	DAT-12 244
			DAT-6 243	DAT-6 243
			DAT-6P 243	DAT-6P 243
	VARIOUS MODELS	-	DAT-11 243	DAT-11 243
			DAT-11D 243	DAT-11D 243
			DAT-11DP 243	DAT-11DP 243
			DAT-11P 244	DAT-11P 244
			DAT-13 244	DAT-13 244
			DAT-13P 244	DAT-13P 244
			DAT-14 244	DAT-14 244
			DAT-14P 244	DAT-14P 244
			DAT-15C1 356	DAT-15C1 356
			DAT-15P4 244	DAT-15P4 244
			DAT-17 244	DAT-17 244
			DAT-17D 244	DAT-17D 244
			DAT-18 244	DAT-18 244
			DAT-3D 242	DAT-3D 242
			DAT-3I 242	DAT-3I 242
			DAT-4D 242	DAT-4D 242
			DAT-6D 243	DAT-6D 243
			DAT-6DP 243	DAT-6DP 243
NISSAN (AUSTRALIA) ®	350Z	2002-2005	KRCDAT-15 365	KRCDAT-15 365
	MURANO	2005-2008		
	PATHFINDER	2002-2005		
	TIIDA	2005-2013		
	X-TRAIL	2004-2007		
	PINTARA	-1983	DAT-12 245	DAT-12 245
	PULSAR	-1983	DAT-6 245	DAT-6 245



FOR: PARA:	MODEL MODELO	CCCCC	PAG.	PAG.
NISSAN (AUSTRALIA) ®			DAT-6P 245	DAT-6P 245
			DAT-7 245	DAT-7 245
			DAT-7P 245	DAT-7P 245
NISSAN (USA) ®	350Z	2003-2008	KRCDAT-15 365	KRCDAT-15 365
	ALTIMA	2002-2004		
	ALTIMA	2005-2006		
	ARMADA	2004-2008		
	ARMADA	2009-2012		
	CUBE	2009-2014		
	FRONTIER	2005-2005		
	FRONTIER	2014-2014		
	JUKE	2011-2012		
	MAXIMA	2001-2001		
	MAXIMA	2002-2003		
	MAXIMA	2004-2006		
	MURANO	2003-2007		
	NV	2012-2012		
	NV	2013-2015		
	PATHFINDER	1999-2001		
	PATHFINDER	2002-2004		
	PATHFINDER	2005-2012		
	QUEST	2004-2010		
	ROGUE	2008-2016		
	SENTRA	2000-2004		
	SENTRA	2007-2012		
	TIIDA	2013-2016		
	VERSA	2007-2009		
	VERSA	2010-2012		
	XTERRA	2001-2001		
	XTERRA	2002-2004		
	XTERRA	2005-2011		
	XTERRA	2012-2015		
	810	1980-1982	DAT-2D 245	DAT-2D 245
			DAT-2DP 245	DAT-2DP 245
			DAT-2I 245	DAT-2I 245
			DAT-2IP 245	DAT-2IP 245
	810	1983-	DAT-12 246	DAT-12 246
			DAT-6 245	DAT-6 245
			DAT-6P 246	DAT-6P 246
			DAT-7 245	DAT-7 245
			DAT-7P 246	DAT-7P 246
NSU ®	RO 80	-19-	VO-7 246	VO-7 246
OLDS MOBILE ®	AURORA	2001-2003	KRCGM-28 365	KRCGM-28 365
	SILHOUETTE	1997-1998	KRCGM-27 365	KRCGM-27 365
	SILHOUETTE	1999-2000		
	SILHOUETTE	2001-2005		
OM IVECO ®	50.10	1979-1981	LF-RO 247	IMS-3 246
	60.10	1979-1981	LF-ROP 247	IMS-3P 247
	65.10	1979-		IMS-5 246
	70.10	1979-		IMS-5P 247
	50.10	1981-	SIP-1 247	IMS-3 246
	60.10	1981-		IMS-3P 247
	70.10	1981-		IMS-5 246



Automóvil. Camioneta
Automobila. Kamioneta
Voiture. Camionnette

Auto. Kleintransporter
Automóvil. Camioneta
Automóvil. Camioneta

FOR: PARA:	MODEL MODELO			PAG.		PAG.
OM IVECO ®	75.10				IMS-5P	247
	79.10					
	79.13					
	100.13	-19-	AF-8D	246	IMS-3	246
	160.26	-19-	AF-8DP	246	IMS-3P	247
	160	-19-	AF-8I	246	IMS-5	246
			AF-8IP	246	IMS-5P	247
			AF-9D	246		
			AF-9DP	246		
			AF-9I	246		
			AF-9IP	246		
	100.13	-1978	AF-9D	246	IMS-3	246
	110.110P	-1978	AF-9DP	246	IMS-3P	247
	110.13	-1978	AF-9I	246	IMS-5	246
	130	-1978	AF-9IP	246	IMS-5P	247
			FEM-ID	246		
			FEM-II	246		
	130 R	-19-	FEM-ID	246	IMS-3	246
	130 R/H	-19-	FEM-II	246	IMS-3P	247
	130 T/H	-19-			IMS-5	246
	130	-19-			IMS-5P	247
	150 R20	-19-	AF-9D	246	FI-5D	246
	150 T20	-19-	AF-9DP	246	FI-5I	246
	150.20	-19-	AF-9I	246	IMS-3	246
	159.20	-19-	AF-9IP	246	IMS-3P	247
	190 T30	-19-			IMS-5	246
	190.30	-19-			IMS-5P	247
	190.35	-19-	AF-7I	246	IMS-3	246
			IMS-12	247	IMS-12	247
	190.38	-19-	AF-7IP	246	IMS-3P	247
			IMS-3	246	IMS-3	246
			AF-9D	246	IMS-5	246
			IMS-3P	247	IMS-3P	247
			AF-9DP	246	IMS-5P	247
			AF-9I	246		
			AF-9IP	246		
			IMS-5	246	IMS-5	246
			IMS-5P	247	IMS-5P	247
	190.38 TUR.	-19-	AF-7I	246	IMS-3	246
			AF-7IP	246	IMS-3P	247
			AF-9D	246	IMS-5	246
			AF-9DP	246	IMS-5P	247
			AF-9I	246		
			AF-9IP	246		
	330.26	-19-	VO-VB	247	IMS-3	246
	330.35	-19-	VO-VBP	247	IMS-3P	247
					IMS-5	246
					IMS-5P	247
	40	-19-	AF-9D	246	AF-5D	246
			AF-9DP	246	AF-5I	246
			AF-9I	246	AF-6D	246
			AF-9IP	246	AF-6I	246
	75	-19-	AF-9D	246	FI-5D	246
			AF-9DP	246	FI-5I	246
			AF-9I	246	IMS-3	246
			AF-9IP	246	IMS-3P	247
			FEM-ID	246	IMS-5	246

FOR: PARA:	MODEL MODELO			PAG.		PAG.
OM IVECO ®			FEM-II	246	IMS-5P	247
	DAINO 145	-19-	BH-4	246	AF-5D	246
	LUPETTO	-19-			AF-5I	246
					AF-6D	246
					AF-6I	246
	GRINTA	-19-	AF-7I	246	IMS-3	246
			AF-7IP	246	IMS-3P	247
			FI-9I	246	IMS-5	246
			FI-9IP	246	IMS-5P	247
			LF-RO	247		
			LF-ROP	247		
	LEONCINO	-19-	BH-4	246	AF-4D	246
					AF-4I	246
	ORSETTO	-19-	FEM-ID	246	AF-5D	246
			FEM-II	246	AF-5I	246
					AF-6D	246
					AF-6I	246
OPEL-VAUXHALL ®	ADAM	2013-2016	KRCOP-II	365	KRCOP-II	365
	ASTRA	2009-2015				
	CASCADA	2013-2017				
	INSIGNIA	2008-2017				
	MOKKA	2012-				
	ZAFIRA	2013-				
	ADMIRAL	-1973	OP-6	248	OP-6	248
	KADETT	-1973	OP-7	248	OP-7	248
	OLIMPIYA	-1973	OP-8	248	OP-8	248
	REKORD	-1973	OP-9	248	OP-9	248
			OP-BB	248	OP-BB	248
			OP-EE	248	OP-EE	248
			OP-FF	248	OP-FF	248
	ANTARA	-2012	KRCDAE-4	365	KRCDAE-4	365
	ASCONA	-1974	OP-HA	248	OP-HA	248
	MANTA	-1974	OP-HB	248	OP-HB	248
			OP-HG	249	OP-HG	249
			OP-HH	249	OP-HH	249
	ASCONA	1975-1981	OP-AB	248	OP-AB	248
	MANTA	1975-1981	OP-ABP	248	OP-ABP	248
			OP-BA	248	OP-BA	248
			OP-BAP	248	OP-BAP	248
			OP-J	249	OP-J	249
			OP-JP	249	OP-JP	249
	ASCONA	1982-	OP-WHP	249	OP-WHP	249
	CALIBRA	1987-1995	OP-WYP	249	OP-WYP	249
	CARAVAN	1992-				
	COMMODORE	1982-				
	MANTA	1982-				
	MONZA	1984-				
	OMEGA	1987-1995				
	REKORD	1984-				
	VECTRA	1987-1995				
	ASTRA	1991-1995	OP-D	248	OP-D	248
			OP-DP	248	OP-DP	248
			OP-S	248	OP-S	248
			OP-SP	248	OP-SP	248
	ASTRA	1998-2004	KRCOP-S	365	KRCOP-S	365
	ZAFIRA	2001-2005				

FOR: PARA:	MODEL MODELO			PAG.		PAG.
OPEL-VAUXHALL ®	ASTRA VAN	1991-1995	OP-D	248	OP-D	248
	COMBO	-19-	OP-DP	248	OP-DP	248
	CORSA	1984-1995	OP-D	248	OP-D	248
	CORSA VAN	1984-1995	OP-DP	248	OP-DP	248
	KADETT	1984-	OP-S	248	OP-S	248
			OP-SP	248	OP-SP	248
	FRONTERA	1992-1996	GM-4	247	GM-4	247
	MONTERREY	1992-	GM-4P	247	GM-4P	247
			GM-4P1	247	GM-4P1	247
	KADETT	1973-1983	OP-AB	248	OP-AB	248
			OP-ABP	248	OP-ABP	248
			OP-BA	248	OP-BA	248
			OP-BAP	248	OP-BAP	248
			OP-J	249	OP-J	249
			OP-JP	249	OP-JP	249
	MANTA 1.8	1975-1979	OP-J	249	OP-J	249
			OP-JP	249	OP-JP	249
	MIDI	1992-	MIT-3	248	MIT-3	248
			MIT-3P	248	MIT-3P	248
	MONZA	1974-1981	OP-R	249	OP-R	249
	REKORD	1974-1984	OP-RP	249	OP-RP	249
	SENATOR	1984-	OP-T	249	OP-T	249
			OP-TP	249	OP-TP	249
	MONZA	1981-1984	GM-9	247	OP-R	249
	SENATOR	1981-1984	GM-9P	248	OP-RP	249
			GM-J	248	OP-T	249
			GM-JP	248	OP-TP	249
	TIGRA	1994-	OP-SP1	249	OP-SP1	249
	VARIOUS MODELS	-	DAC-4DP	247	DAC-4DP	247
			DAC-5C1	356	DAC-5C1	356
			DAC-6DP	247	DAC-6DP	247
			HU-SR	248	HU-SR	248
			NE-60C1	356	NE-60C1	356
			NE-60C3	356	NE-60C3	356
			OP-CC	248	OP-CC	248
			OP-NA	248	OP-NA	248
			OP-NB	248	OP-NB	248
			OP-WHC1	356	OP-WHC1	356
	VARIOUS MODELS	2003-2019	OP-11C1	356	OP-11C1	356
	VARIOUS MODELS	2010-	OP-11C3	356	OP-11C3	356
PEUGEOT ®	104	1972-	LMP-1	250	VA-6	253
			LMP-1P	250	VA-6P	253
			NE-4	250		
			NE-4P	250		
			NE-4P1	251		
	104	1978-	NE-4	250	NE-4	250
			NE-4P	250	NE-4P	250
			NE-4P1	251	NE-4P1	251
			LAS-V	250	LAS-V	250
	104	1979-	LMP-2	250	LAS-V	250
			LMP-2P	250	VA-6	253
			NE-4	250	VA-6P	253
			NE-4P	250		

FOR: PARA:	MODEL MODELO			PAG.		PAG.
PEUGEOT ®			NE-4P1	251		
	104	1980-	CHR-3	249	CHR-3	249
			CHR-3P	249	CHR-3P	249
			LAS-V	250	LAS-V	250
			VA-6	253	VA-6	253
			NE-22P1	251	NE-22P1	251
			VA-6P	253		
	104	1981-	LMP-4	250	LMP-4	250
			LMP-4P	250	LMP-4P	250
			LMP-5	250	LMP-5	250
			LMP-5P	250	LMP-5P	250
			LAS-V	250	LAS-V	250
			VA-6	253	VA-6	253
			VA-6P	253	VA-6P	253
			FAR-ID	249	FAR-ID	249
			FAR-II	249	FAR-II	249
			FAR-2D	249	FAR-2D	249
			FAR-2I	249	FAR-2I	249
	104	1982-	CHR-3	249	CHR-3	249
			VA-18	253	VA-18	253
	305	1983-1987	CHR-3P	249	CHR-3P	249
			NE-22P1	251	NE-22P1	251
	106	1991-1997	NE-36	251	NE-36	251
			NE-36P1	251	NE-36P1	251
	106 SERVICE	-1993	NE-19	251	NE-19	251
	205 SERVICE	-1993	NE-20P1	251	NE-20P1	251
	107	2004-2014	CIT-1C1	356	CIT-1C1	356
	2008	2012-2016	KRCHU-HAA	365	KRCHU-HAA	365
	204	1965-	NE-37	252	VA-6	253
	304	1969-1978	NE-37P	252	VA-6P	253
	404	1965-	NE-4	250		
	504 BERLINA	1968-1974	NE-4P	250		
			NE-4P1	251		
	205	1984-	NE-20	251	NE-20	251
			NE-20P	251	NE-20P	251
			NE-29	251	NE-29	251
			NE-29P	251	NE-29P	251
	205	1985-1991	NE-20	251	NE-20	251
			NE-20P1	251	NE-20P1	251
			NE-29	251	NE-29	251
	205	1991-1993	NE-20	251	NE-20	251
	405	1991-1993	NE-20P1	251	NE-20P1	251
			NE-29	251	NE-29	251
			NE-36	251	NE-36	251
			NE-36P1	251	NE-36P1	251
	205	1993-	NE-20P2	251	NE-20P2	251
	405	1993-	NE-36	251	NE-36	251
			NE-36P1	251	NE-36P1	251
	207	2006-2012	KRCHU-HCA	365	KRCHU-HCA	365
	208	2012-2018				
	3008	2009-2016				

Automóvil. Camioneta
Automobila. Kamioneta
Voiture. Camionnette

Auto. Kleintransporter
Automóvil. Camioneta
Automóvil. Camioneta

FOR: PARA:	MODEL MODELO			PAG.		PAG.
PEUGEOT®	807	2005-2009				
	807	2009-2014				
EXPERT	2007-2009					
	2009-					
305	1978-1980	CHR-3	249	CHR-3	249	
		CHR-3P	249	CHR-3P	249	
		LAS-V	250	LAS-V	250	
		VA-6	253	VA-6	253	
		VA-6P	253	VA-6P	253	
		PJ-K	252	PJ-K	252	
		PJ-KP	252	PJ-KP	252	
		NE-22P1	251	NE-22P1	251	
305	1981-1982	SIX-1	252	SIX-1	252	
		SIX-1P1	252	SIX-1P1	252	
		LAS-V	250	LAS-V	250	
		PJ-K	252	PJ-K	252	
		PJ-KP	252	PJ-KP	252	
		CHR-3	249	CHR-3	249	
305 SERVICE	1983-	CHR-3	249	CHR-3	249	
		NE-22P1	251	NE-22P1	251	
		VA-18	253	VA-18	253	
		NE-20P2	251	NE-20P2	251	
306	1993-1997	NE-20P2	251	NE-20P2	251	
309	1985-	NE-36	251	NE-36	251	
		NE-20	251	NE-20	251	
405	1987-1991	NE-20P1	251	NE-20P1	251	
		NE-29	251	NE-29	251	
		NE-29P	251	NE-29P	251	
		NE-19	251	NE-19	251	
309 SERVICE	1985-	NE-19	251	NE-19	251	
405 AFFAIRE	1987-1991	NE-20P1	251	NE-20P1	251	
406	1995-1997	NE-51P2	252	NE-51P2	252	
407	2004-2008	KRCCIT-1	365	KRCCIT-1	365	
508	2010-2014					
PARTNER	2008-2013					
504	1975-	NE-4	250	NE-4	250	
		NE-4P	250	NE-4P	250	
		NE-4P1	251	NE-4P1	251	
		LAS-V	250	LAS-V	250	
504 BREAK	1968-1974	NE-4	250	RO-11D	252	
		NE-4P	250			
		NE-4P1	251			
		NE-4	250	NE-4	250	
		NE-4P1	251	NE-4P1	251	
		CHR-3	249	CHR-3	249	
505	1979-1980	CHR-3P	249	CHR-3P	249	
		NE-22P1	251	NE-22P1	251	
		LAS-V	250	LAS-V	250	
		VA-6	253	VA-6	253	
		VA-6P	253	VA-6P	253	
		NE-20	251	NE-20	251	
505	1984-	NE-20P	251	NE-20P	251	
		VA-6	253	VA-6	253	
		VA-6P	253	VA-6P	253	
		NE-20	251	NE-20	251	
		NE-20P1	251	NE-20P1	251	
		NE-29	251	NE-29	251	
		VA-18	253	VA-18	253	
		LMP-4	250	LMP-4	250	
505 BERLINA	1981-1983	LMP-4P	250	LMP-4P	250	

FOR: PARA:	MODEL MODELO			PAG.		PAG.
PEUGEOT®		LMP-5	250	LMP-5	250	
		LMP-5P	250	LMP-5P	250	
		LAS-V	250	LAS-V	250	
		VA-6	253	VA-6	253	
		VA-6P	253	VA-6P	253	
		CHR-3	249	CHR-3	249	
505 BREAK	1981-1983	CHR-3	249	CHR-3	249	
		CHR-3P	249	CHR-3P	249	
		NE-22P1	251	NE-22P1	251	
		LAS-V	250	LAS-V	250	
505 SERVICE	1979-	CHR-3	249	LAS-R	250	
		NE-22P1	251	LAS-V	250	
604	1975-1980	NE-4	250	NE-4	250	
		NE-4P	250	NE-4P	250	
		NE-4P1	251	NE-4P1	251	
		LAS-V	250	LAS-V	250	
604	1981-	CHR-3	249	CHR-3	249	
		CHR-3P	249	CHR-3P	249	
		NE-22P1	251	NE-22P1	251	
		VA-6	253	VA-6	253	
		VA-6P	253	VA-6P	253	
		NE-34P	251	NE-34P	251	
605	1990-	NE-34P	251	NE-34P	251	
806	1994-	SIX-3P1	252	SIX-3P1	252	
EXPERT	1995-1996					
J-5	-19-	FI-12	249	FI-12	249	
		FI-12P3	250	FI-12P3	250	
		FI-3D	249	FI-3D	249	
		FI-3DP3	250	FI-3DP3	250	
		FI-6I	250	FI-6I	250	
		FI-6IP3	250	FI-6IP3	250	
J-7	-19-	NE-4	250			
		NE-4P1	251			
J-9	-19-	NE-4	250	RO-4D	252	
		NE-4P1	251	RO-4I	252	
				RO-5D	252	
				RO-5I	252	
PARTNER	1997-	SIX-3P1	252	SIX-3P1	252	
RANCH	1997-	SIX-3P2	252	SIX-3P2	252	
VARIOUS MODELS	-	CHR-4I	249	CHR-4I	249	
		CHR-4D	249	CHR-4D	249	
		HU-HCAP	250	HU-HCAP	250	
		NE-4D	250	NE-4D	250	
		NE-4P2	251	NE-4P2	251	
		NE-60C2	356	NE-60C2	356	
		PEU-2C1	357	PEU-2C1	357	
		RO-11I	252	RO-11I	252	
		RO-14	252	RO-14	252	
		RO-1D	252	RO-1D	252	
		RO-1DS	249	RO-1DS	249	
		RO-1I	252	RO-1I	252	
		RO-1IS	249	RO-1IS	249	
		RO-2D		RO-2D		
		RO-2I		RO-2I		
		RO-6D	252	RO-6D	252	
		RO-6I	252	RO-6I	252	
		RO-8I		RO-8I		
		NE-36P	251	NE-36P	251	
		NE-39P	252	NE-39P	252	

FOR: PARA:	MODEL MODELO			PAG.		PAG.
PEUGEOT®	VARIOUS MODELS	2004-2018	PEU-1C1	356	PEU-1C1	356
	VARIOUS MODELS	2005-	NE-60C3	356	NE-60C3	356
PEUGEOT (ARGEN.)®	VARIOUS BRANDS	-	NE-4D	253	NE-4D	253
PEUGEOT (ARGEN.)®	404	-19-	NE-3	253	NE-43	254
			GAS-1	253	GAS-1	253
			NE-43	254	NE-43	254
			NE-3P	253		
			NE-3P2	253		
			NE-20	253	NE-20	253
405	-19-		NE-20P1	254	NE-20P1	254
			NE-3	253	NE-3	253
504	-19-		GAS-1	253	GAS-1	253
			NE-43	254	NE-43	254
			NE-3P	253	NE-3P	253
			NE-3P2	253	NE-3P2	253
			NE-4	253	NE-4	253
			NE-4P	253	NE-4P	253
504 PICK UP	-19-		NE-4	253	NE-4	253
			NE-4P	253	NE-4P	253
			GAS-1	253	GAS-1	253
			NE-43	254	NE-43	254
505	-19-		NE-20	253	NE-20	253
			NE-20P1	254	NE-20P1	254
			NE-42	254	NE-42	254
			NE-42P	254	NE-42P	254
			NE-42P1	254	NE-42P1	254
			NE-53	254	NE-53	254
PIAGGIO®	PORTER	1993-1994	DAI-1P	254	DAI-1P	254
PLYMOUTH®	ACCLAIM	1990-1992	CHR-9	254	CHR-9	254
	PLYMOUTH	1990-	CHR-9P	254	CHR-9P	254
	ACCLAIM	1993-	CHR-10	254	CHR-10	254
	GRAN VOYAGER	1993-	CHR-10P	254	CHR-10P	254
VOYAGER	1993-					
COLT VISTA	1989-1992	CHR-17	255	CHR-17	255	
LASER	1989-1992					
COLT VISTA	1993-1994	MIT-13D	255	MIT-13D	255	
		MIT-14D	255	MIT-14D	255	
		CHR-14	254	CHR-14	254	
NEON	1995-	CHR-14P	255	CHR-14P	255	
		CHR-15	255	CHR-15	255	
		CHR-15P	255	CHR-15P	255	
		CHR-7	254	CHR-7	254	
PLIMOUTH	1985-1986	CHR-7P	254	CHR-7P	254	
		CHR-8	254	CHR-8	254	
		CHR-8P	254	CHR-8P	254	
		CHR-8	254	CHR-8	254	
SUNDANCE	1989-	CHR-8P	254	CHR-8P	254	
		CHR-8P	254	CHR-8P	254	
VARIOUS MODELS	-	CHR-14P	255	CHR-14P	255	
		CHR-8	254	CHR-8	254	
VOYAGER	1991-1992	CHR-8P	254	CHR-8P	254	

FOR: PARA:	MODEL MODELO			PAG.		PAG.
PONTIAC®	AZTEK	2001-2005	KRCGM-28	365	KRCGM-28	365
	BONNEVILLE	2001-2005				
MONTANA	2007-2009					
	G5	2007-2010	KRCGM-37	366	KRCGM-37	366
G6	2006-2010					
		GRAND PRIX	2004-2004			
GRAND PRIX	2006-2008					
		MONTANA	2005-2006			
SOLSTICE	2006-2006					
TORRENT	2007-2009					
GRAND PRIX	2001-2003	KRCGM-43	366	KRCGM-43	366	
MONTANA	1999-2000	KRCGM-27	365	KRCGM-27	365	
MONTANA	2001-2004					
MONTANA	2005-2005					
TRANS SPORT	1997-1998					
PORSCHE®	911 CARRERA	1970-	PO-HC	255	PO-HC	255
	912	1970-	PO-HCP	255	PO-HCP	255
914	1970-	PO-NC	255	PO-NC	255	
		PO-NCP	255	PO-NCP	255	
924	1975-1993	VO-HV	255	VO-HV	255	
		VO-HVP	256	VO-HVP	256	
944	1975-1993	VO-VB	255	VO-VB	255	
		VO-VBP	256	VO-VBP	256	
928	1977-	PO-IP		PO-IP		

Automóvil. Camioneta
Automobila. Kamioneta
Voiture. Camionnette

Auto. Kleintransporter
Automóvil. Camioneta
Automóvil. Camioneta

FOR: PARA:	MODEL MODELO			PAG.		PAG.
RENAULT (ARGEN.)®	NEVADA	-19-	CHR-3	260	NE-28	261
			NE-22P	261		
	R 4	-19-	NE-3	261	NE-3	261
			NE-3P	261	NE-3P	261
			NE-3P2	261	NE-3P2	261
			NE-4	261	NE-4	261
			NE-4P	261	NE-4P	261
			NE-4P2	261	NE-4P2	261
			GAS-1	261	GAS-1	261
	R 6	-19-	NE-3	261	NE-3	261
			NE-3P	261	NE-3P	261
			NE-3P2	261	NE-3P2	261
	R 9	-19-	NE-22P	261	NE-16	261
			NE-55P	262	NE-55P	262
	R11	-19-	CHR-3	260	NE-16	261
	R18	-19-	NE-22P	261	NE-55P	262
			NE-55P	262	NE-59P	262
	R12	-19-	CHR-3	260	CHR-3	260
			NE-22P	261	NE-22P	261
			NE-4	261	NE-4	261
			NE-4P	261	NE-4P	261
			NE-4P2	261	NE-4P2	261
			NE-43	262	NE-43	262
		GAS-1	261	GAS-1	261	
R19	-19-	NE-36	261	NE-36	261	
		NE-36P1	261	NE-36P1	261	
R21	-19-	CHR-3	260	NE-28	261	
		NE-22P	261	VA-10	262	
		NE-55P	262			
TRAFFIC	-19-	CHR-3	260	NE-16	261	
		NE-22P	261	NE-53	262	
		NE-55P	262	NE-59P	262	
RENAULT®	R 4	1961-1991	NE-4	258	NE-4	258
			NE-4P	258	NE-4P	258
			NE-4P1	258	NE-4P1	258
			NE-4P2	258	NE-4P2	258
	R 5	1972-1979	LMP-2	257	RO-15	260
			LMP-2P	257	VA-7	260
			FAB-1	257	FAB-1	257
			NE-15D	258		
			NE-15DP	258		
			NE-15I	258		
			NE-15IP	258		
	R 5	1979-	NE-15D	258	NE-16	258
			NE-15DP	258	NE-59P	260
			NE-15I	258		
			NE-15IP	258		
	R 5	1980-	CHR-3	257	NE-16	258
			CHR-3P	257	NE-59P	260
			LMP-4	258		
			LMP-4P1	258		
	R 5	1981-	CHR-3	257	VA-10	260
			CHR-3P	257		
	R 5	1982-	CHR-3	257	VA-10	260
			CHR-3P	257		
			BL-2	257	BL-2	257

FOR: PARA:	MODEL MODELO			PAG.		PAG.
RENAULT®			LAS-V	257	LAS-V	257
			LMP-4	258		
			LMP-4P1	258		
			LMP-5	258		
			LMP-5P1	258		
	R 5	1983-1984	CHR-3	257	VA-10	260
			CHR-3P	257		
	R 5	1985-1986	NE-19	259	VA-10	260
			NE-19P1	259		
	R 5	1986-	NE-19	259	NE-28	259
			NE-19P1	259		
	R 6	1968-	LMP-1	257	RO-15	260
			LMP-1P	257		
			NE-15I	258		
			NE-15IP	258		
	R 7	-19-	NE-15I	258	NE-16	258
			NE-15IP	258	NE-4	258
			NE-4	258	NE-4P2	258
			NE-4P2	258	NE-59P	260
			FAR-1D	257	FAR-1D	257
	R 9	-19-	NE-55P	260		
	R 11	-19-				
	R 12	-19-				
	R 21 NEVADA	-19-				
	FUEGO	-19-				
	TRAFFIC	-19-				
	R 9	1981-	CHR-3	257	NE-16	258
	R 11	1981-	CHR-3P	257	NE-59P	260
			LMP-5	258		
			LMP-5P1	258		
	R 9	1982-1983	CHR-3	257	BS-5	257
	R 11	1982-1983	CHR-3P	257	NE-16	258
					NE-59P	260
					VA-10	260
	R 9	1984-	NE-19	259	NE-16	258
			VA-17P	260	VA-17P	260
	R 11	1984-	NE-19P	259	NE-59P	260
					VA-10	260
					VA-17P	260
	R 12	1969-1971	LMP-1	257	RO-15	260
			LMP-1P	257		
	R 12	1972-	LMP-2	257	VA-7	260
			LMP-2P	257		
	R 14	1976-1977	CHR-3	257	NE-16	258
			CHR-3P	257	NE-59P	260
			NE-15I	258		
			NE-15IP	258		
	R 14	1978-1979	CHR-3	257	VA-7	260
			CHR-3P	257		
	R 14	1980-	CHR-3	257	NE-16	258
			CHR-3P	257	NE-59P	260
			LMP-4	258	VA-10	260
			LMP-4P1	258		
	R 15	1971-	NE-15I	258	RO-15	260
	R 17	1971-	NE-15IP	258		

FOR: PARA:	MODEL MODELO			PAG.		PAG.
RENAULT®	R 16	1965-	NE-3	258	RO-15	260
			NE-3P1	258		
			NE-3P2	258		
	R 18	1978-1980	CHR-3	257	NE-16	258
	FUEGO	1978-1980	CHR-3P	257	NE-59P	260
	R 18	1980-1982	CHR-3	257	VA-10	260
	FUEGO	1982-	CHR-3P	257		
			LMP-5	258		
			LMP-5P1	258		
	R 18	1983-	CHR-3	257	VA-10	260
			CHR-3P	257		
			NE-19	259		
			NE-19P1	259		
			NE-22P	259		
			NE-55P	260		
	R 19	1988-1990	NE-19	259	NE-19	259
			NE-19P1	259	NE-19P1	259
			VA-10	260	VA-10	260
	R 19	1990-	NE-19	259	NE-19	259
			NE-19P1	259	NE-19P1	259
			NE-36	259	NE-36	259
			NE-36P1	259	NE-36P1	259
	R 20	1975-	CHR-3	257	VA-17P	260
	R 30	1975-	CHR-3P	257		
			LMP-4	258		
			LMP-4P1	258		
			NE-22P	259		
	R 21	1986-1989	NE-19	259	NE-28	259
			NE-19P1	259	VA-10	260
			NE-36	259	NE-36	259
	R 21	1990-1991	NE-36P1	259	NE-36P1	259
			NE-38	259	NE-38	259
	R 21	1992-	NE-38P1	259	NE-38P1	259
	R 25	1992-	NE-38P1	259	NE-38P1	259
	SAFRANE	1992-1995				
	R 25	1983-1988	NE-19	259	VA-17P	260
			NE-19P1	259		
	R 25	1989-1991	NE-36	259	VA-17P	260
			NE-36P1	259		
	ALPINE	1992-	NE-19	259	NE-19	259
			NE-19P1	259	NE-19P1	259
	CLIO	1990-1998	NE-36	259	NE-36	259
			NE-36P1	259	NE-36P1	259
			VA-34	260	VA-34	260
			VA-34P	260	VA-34P	260
			VA-34P1	260	VA-34P1	260
			VA-34P2	260	VA-34P2	260
	CLIO II	2001-2008	KRCNE-36	366	KRCNE-36	366
	CLIO III	2006-2010	KRCCIT-1	366	KRCCIT-1	366
	MODUS	2004-2012				
	COACH	1995-1996	NE-38	259	NE-38	259
	MEGANE	1995-1996	NE-38P1	259	NE-38P1	259
	ESPACE	1984-1997	NE-19	259	VA-10	260
			NE-19P1	259		
			NE-36	259		
			NE-36P1	259		
	KANGOO	1998-2010	VA-34P	260	VA-34P	260
	LAGUNA	1994-2001	VA-34P1	260	VA-34P1	260

FOR: PARA:	MODEL MODELO			PAG.		PAG.
RENAULT®	SAFRANE	1995-2001	VA-34P2	260	VA-34P2	260
	TWINGO	1994-2007				
	LAGUNA	1994-	NE-38	259	NE-38	259
			NE-38P1	259	NE-38P1	259
			VA-34	260	VA-34	260
	LAGUNA 2ºse.	1994-	VA-34	260	NE-50P	260
	TWINGO	1993-1994	NE-36	259	NE-36	259
	TWINGO	1995-				
	TWINGO	1993-1995	NE-36P	259	NE-36P	259
	VARIOUS MODELS	-	AMM-1	257	AMM-1	257
			NE-15DP1	258	NE-15DP1	258
			NE-3D	258	NE-3D	258
			NE-5	258	NE-5	258
			NE-60C2	357	NE-60C2	357
			RO-11D	260	RO-11D	260
			RO-11I	260	RO-11I	260
			RO-1D	260	RO-1D	260
			RO-1DS	257	RO-1DS	257
			RO-1I	260	RO-1I	260
			RO-11S	257	RO-11S	257
			RO-2D		RO-2D	
			RO-2I		RO-2I	
			RO-6D	260	RO-6D	260
			RO-6I			

Automóvil. Camioneta
Automobila. Kamioneta
Voiture. Camionnette

Auto. Kleintransporter
Automóvil. Camioneta
Automóvil. Camioneta

FOR: PARA:	MODEL MODELO	CCCCC		PAG.		PAG.	
RENAULT SAVIEM ®	EXPRESS-B-D	-1987	NE-19	263	NE-19	263	
			NE-19P	263	NE-19P	263	
			NE-19P1	263	NE-19P1	263	
			LAS-R	262	LAS-R	262	
			LAS-V	262	LAS-V	262	
		EXPRESS-B-D	1987-1991	NE-19	263	NE-28	263
				NE-19P1	263		
		JK 50-60	-19-	BH-1	262	RO-15	264
		JK 75-90	-19-	BH-1P	262	RO-4D	264
		JK 110-115	-19-			RO-4I	264
		JP 11	-19-	BH-1	262	RO-4D	264
				LAS-R	262	LAS-R	262
		JP 13	-19-	BH-1P	262	RO-4I	264
				LAS-V	262	LAS-V	262
		JP 13 TU	-19-				
		JP 115	-19-				
		MASTER P35 D	-1987	CHR-3	262	VA-7	264
				NE-28	263	NE-28	263
		MASTER T30 D	-1987	CHR-3P	262		
		MASTER T35 D	-1987	LMP-5	262		
				LMP-5P1	262		
				NE-22P	263		
		MASTER T30 D	1987-	CHR-3	262	NE-28	263
		MASTER T35 D	1987-	NE-22P	263		
		MASTER TURBO	1987-				
		R 11 CARGO	-1991	NE-19	263	VA-10	264
				NE-19P1	263		
				PJ-1	264	PJ-1	264
				PJ-2	264	PJ-2	264
				PJ-2P	264	PJ-2P	264
		R 19 TD	-1992	NE-19	263	NE-19	263
				NE-19P1	263	NE-19P1	263
				VA-10	264	VA-10	264
				RO-7D		RO-7D	
		R4 F4 C. 850	-1994	NE-4	263	NE-4	263
		R4 F4 C.1100	-1994	NE-4P	263	NE-4P	263
				NE-4P2	263	NE-4P2	263
		SUPERCINCO D	-1991	NE-19	263	NE-28	263
			NE-19P1	263			
	TRAFFIC	-1987	CHR-3	262	RO-17	264	
			CHR-3P	262			
			NE-22P	263			
	TRAFFIC	1988-	NE-19	263	NE-28	263	
			NE-19P	263			
	VARIOUS MODELS	-19-	NE-20P	263	NE-20P	263	
			NE-20P1	263	NE-20P1	263	
			NE-20P2	263	NE-20P2	263	
			NE-20P3	263	NE-20P3	263	
			NE-36	263	NE-36	263	
			NE-36P	264	NE-36P	264	
			NE-36P1	264	NE-36P1	264	
			NE-39P	264	NE-39P	264	
ROLLS ROYCE ®	ALGUNOS-SOME	1995-	YA-20D	264	YA-20D	264	
	CLOUD	-1970					
	SHADOW	-1970					

FOR: PARA:	MODEL MODELO	CCCCC		PAG.		PAG.	
ROLLS ROYCE ®	CLOUD	1981-1997	YA-21I	265	YA-21I	265	
	SHADOW	1981-1997					
	SHADOW	1971-1980	YA-21I	265	YA-20D	264	
	SPIRIT	1971-1980			YA-20I	264	
	SPUR	1971-1980					
	VARIOUS MODELS	1970-1973	YA-18D	264	YA-18D	264	
					YA-19D	264	
					YA-20I	264	
		WRAITH	1971-1980				
		SPIRIT	1980-1983	YA-20I	264	YA-20I	264
				YA-21I	265	YA-21I	265
		SPUR	1980-1983	YA-21I	265	YA-21I	265
	ROVER ®	2000	1976-1981	LF-RO	265	LF-RO	265
				FO-E-TC	265	FO-E-TC	265
		2300	1976-1981	LF-ROP	265	LF-ROP	265
				FO-E-TC	265	FO-E-TC	265
2400		1976-1981					
2600		1976-1981	LF-RO	265	LF-RO	265	
			LF-ROP	265	LF-ROP	265	
3500		1976-1981					
2000		1982-1985	LF-RO	265	LF-RO	265	
2200		1982-1985	LF-ROP	265	LF-ROP	265	
			FO-E-TC	265	FO-E-TC	265	
			FO-E-TCP	265	FO-E-TCP	265	
2300		1982-1985	NE-11	265	NE-11	265	
			FO-E-TC	265	FO-E-TC	265	
			FO-E-TCP	265	FO-E-TCP	265	
2400		1982-1985	NE-11P	265	NE-11P	265	
2600	1982-1985						
3500	1982-1985						
2000	1985-	LF-RO	265	LF-RO	265		
2300	1985-	LF-ROP	265	LF-ROP	265		
		FO-E-TC	265	FO-E-TC	265		
		FO-E-TCP	265	FO-E-TCP	265		
2400	1985-	LF-ROP	265	LF-ROP	265		
2600	1985-						
2000 SC/TC	1963-1975	LF-9	265	UN-4	265		
		IN-4	265	IN-4	265		
3500	1963-1975	LF-9	265	UN-4	265		
25	2000-	NE-35P2	266	NE-35P2	266		
3500 V8 S	1976-	LF-9	265	UN-1FS	267		
		LF-RO	265	UN-4	265		
		LF-ROP	265				
		FO-E-TC	265	FO-E-TC	265		
		FO-E-TCP	265	FO-E-TCP	265		
416	1995-1996	NE-35P2	266	NE-35P2	266		
620	1995-1996						
820	1992-1994	NE-52P	266	NE-52P	266		
825	1992-1994						
ALLEGRO	1973-	LF-RO	265	UN-FT	267		
		LF-ROP	265				
		PJ-2	266	PJ-2	266		
		PJ-2P	266	PJ-2P	266		
ALLEGRO 2	1973-	LF-BL	265	UN-FT	267		
		LF-RO	265				
		LF-ROP	265				

FOR: PARA:	MODEL MODELO	CCCCC		PAG.		PAG.
ROVER ®			WAS-1	267	WAS-1	267
	ALLEGRO 3	1973-	LF-BL	265	UN-FT	267
			LF-RO	265		
			LF-ROP	265		
			NE-11	265		
			NE-11P	265		
			WAS-1	267	UN-FT	267
	FX 4S (TAXI)	-19-	LF-BL	265	IN-4	265
			LF-RO	265	IN-5	265
			LF-ROP	265		
			UN-FS	267	UN-FS	267
	MAESTRO	1983-	NE-11	265	NE-11	265
			NE-11P	265	NE-11P	265
			NE-11P1	266	NE-11P1	266
			NE-11P2	266	NE-11P2	266
			NE-24	266	NE-24	266
			NE-24P	266	NE-24P	266
			NE-24P1	266	NE-24P1	266
			PJ-2	266	PJ-2	266
			PJ-2P	266	PJ-2P	266
	MARINA	-19-	LF-BL	265	UN-FT	267
			LF-RO	265		
			LF-ROP	265		
			NE-1	265		
			NE-1P	265		
	MAXI	1969-	NE-1	265	UN-FS	267
	TRAVELLER	1969-	NE-1P	265		
	METRO	1980-1983	NE-11	265	NE-14	266
			NE-11P	265		
	METRO	1984-1989	NE-11	265	NE-14	266
			NE-11P	265		
			PJ-2	266	PJ-2	266
			PJ-2P	266	PJ-2P	266
	MINI	1959-1973	UN-FS	267	UN-FS	267
	MINI	1974-1984	LF-BL	265	UN-FS	267
			LF-RO	265		
			LF-ROP	265		
			PJ-2	266	PJ-2	266
		PJ-2P	266	PJ-2P	266	
MINI	1985-	NE-11	265	UN-FS	267	
		NE-11P1	266			
		NE-11P2	266			
		PJ-K	266	PJ-K	266	
		PJ-KP	267	PJ-KP	267	
MONTEGO	1984-1988	NE-11	265	NE-14	266	
		NE-11P	265			
		NE-24	266			
		NE-24P	266			
		PJ-2	266	PJ-2	266	
		PJ-2P	266	PJ-2P	266	
MONTEGO	1988-1991	NE-11	265	NE-11	265	
		NE-11P1	266	NE-11P1	266	
		NE-11P2	266	NE-11P2	266	
		NE-24	266	NE-24	266	
		NE-24P1	266	NE-24P1	266	
MONTEGO	1992-	NE-35	266	NE-35	266	
		NE-35P	266	NE-35P	266	

FOR: PARA:	MODEL MODELO	CCCCC		PAG.		PAG.	
ROVER ®	PRINCESS	-19-	NE-11	265	LF-RO	265	
			NE-11P	265	LF-ROP	265	
			WAS-1	267	WAS-1	267	
	SERIE 100	1991-1993	NE-11	265	NE-11	265	
			NE-11P1	266	NE-11P1	266	
			NE-11P2	266	NE-11P2	266	
	SERIE 200	1984-	HOND-10	265	HOND-10	265	
			HOND-10P	265	HOND-10P	265	
	SERIE 200	1985-1989	NE-11	265	NE-11	265	
	SERIE 800	1987-1991	NE-11P	265	NE-11P	265	
			NE-11P1	266	NE-11P1	266	
			NE-11P2	266	NE-11P2	266	
			NE-24	266	NE-24	266	
			NE-24P	266	NE-24P	266	
			NE-24P1	266	NE-24P1	266	
	SERIE 200	1989-1993	NE-35	266	NE-35	266	
	SERIE 400	1989-1993	NE-35P2	266	NE-35P2	266	
	SHERPA 185	-19-	LF-BL	265	UN-1FS	267	
	SHERPA 230	-19-	LF-RO	265	UN-FT	267	
	SHERPA 255	-19-	LF-ROP	265			
	SAAB ®	900	1974-1977	SAA-2P	267	SAA-2P	267
		99	1974-1977				
		900	1978-1993	SAA-AC	267	SAA-AC	267
				SAA-ACP	267	SAA-ACP	267
				WAS-1	267	WAS-1	267
		900	1993-	SAA-1P1	267	SAA-1P1	267
		9000	1986-				
		93	1998-	SAA-1P1	267	SAA-1P1	267
		95	-19-	AS-1D	267	SAA-AC	267
		96					

Automóvil. Camioneta
Automobila. Kamioneta
Voiture. Camionnette

Auto. Kleintransporter
Automóvil. Camioneta
Automóvil. Camioneta

FOR: PARA:	MODEL MODELO			PAG.		PAG.
SUBARU (USA) ®	LIBERTY	2009-2013	KRCSUB-2	366	KRCSUB-2	366
SULKY ®	125	-1991	BH-4	273	ZA-1	274
	50	-1991			ZA-1P	274
SUNBEAM ®	1.0	-19-	LF-SL	274	LF-SL	274
			PJ-2	274	PJ-2	274
	1.3	-19-	LF-SLP	274	LF-SLP	274
			PJ-2P	274	PJ-2P	274
	1.6	-19-	PJ-2	274	PJ-2	274
			LF-SLP	274	LF-SLP	274
			PJ-2P	274	PJ-2P	274
SUZUKI ®	ALTO	1976-1984	TOYO-14	275	TOYO-14	275
	CERVO	1976-1984	TOYO-14P	276	TOYO-14P	276
	CULTUS	1976-1984				
	ESTEEM	1976-1984				
	FRONTE	1976-1984				
	GOLD FINGER	1976-1984				
	JIMMY	1976-1984				
	S.CARRY	1988-				
	SAMURAI	1976-1984				
	SJ 30	1976-1984				
	SJ 310	1976-1984				
	SJ 410	1976-1984				
	SJ 413	1976-1984				
	VITARA	1988-				
	ALTO	1986-1995	SUZU-7	275	SUZU-7	275
	CERVO	1986-	SUZU-7P	275	SUZU-7P	275
	CULTUS	1986-				
	ALTO	1996-	SUZU-8	275	SUZU-8	275
	CARRY VAN	1989-1991	SUZU-8P	275	SUZU-8P	275
	EVERY VAN	1989-1991				
	SWIFT	1989-1991				
	VITARA	1989-1991				
	X-90	1995-1997				
	BALENO	1995-	SUZU-10	275	SUZU-10	275
			SUZU-10P	275	SUZU-10P	275
	CULTUS	1984-1991	MIT-2I	275	MIT-2I	275
	SAMURAI	1984-1989	TOYO-14	275	TOYO-14	275
			TOYO-14P	276	TOYO-14P	276
	ESCUDO	1989-1991	SUZU-10	275	SUZU-10	275
	SIDEKICK	1989-1991	SUZU-10P	275	SUZU-10P	275
	SWIFT	1991-1996				
	FORENZA	2004-2008	DAE-3DP1	274	DAE-3DP1	274
	RENO	2005-2008				
	GRAND VITARA	2008-2013	KRCSUZU-14	366	KRCSUZU-14	366
	SPLASH	2008-2015				
	SWIFT	2005-2010				
	SX4	2006-2012				
	LJ 50	1970-	TOYO-14	275	TOYO-14	275
	LJ 80	1970-	TOYO-14P	276	TOYO-14P	276
			TOYO-K1	275	TOYO-K1	275
			TOYO-K1P	276	TOYO-K1P	276
	RENO	2005-2009	DAE-3DP2	274	DAE-3DP2	274
	SAMURAI	1984-1991	TOYO-14P	276	TOYO-14P	276
	SAMURAI	1989-	IMS-11P	275	IMS-11P	275

FOR: PARA:	MODEL MODELO			PAG.		PAG.
SUZUKI ®			SUZU-9P	275	SUZU-9P	275
	SAMURAI	1992-	TOYO-14P	276	TOYO-14P	276
	SJ 410	1985-1988	IMS-7	274	IMS-10	274
	SJ 413	1985-1988	IMS-7P	274		
	SJ 410	1989-1991	IMS-7	274	IMS-11P	275
	SJ 413	1989-1991	IMS-7P	274	SUZU-9P	275
	VARIOUS MODELS	-	SUZU-14P2	275	SUZU-14P2	275
			SUZU-14P3		SUZU-14P3	
			SUZU-1D	275	SUZU-1D	275
			SUZU-1I	275	SUZU-1I	275
			SUZU-21P	275	SUZU-21P	275
			SUZU-2D	275	SUZU-2D	275
			SUZU-2I	275	SUZU-2I	275
			SUZU-6	275	SUZU-6	275
			SUZU-7DP	275	SUZU-7DP	275
			SUZU-8I	275	SUZU-8I	275
			SUZU-8IP	275	SUZU-8IP	275
			YAMA-20DP	276	YAMA-20DP	276
	VERONA	2004-2007	DAE-4P1	274	DAE-4P1	274
	VITARA	1991-	SUZU-8	275	SUZU-8	275
			SUZU-8P	275	SUZU-8P	275
			SUZU-9P	275	SUZU-9P	275
			IMS-11P	275	IMS-11P	275
TALBOT SIMCA ®	160 GT	1979-	CHR-3	276	CHR-3	276
	180	1979-	NE-22P2	276	NE-22P2	276
	1000	1968-1973	NE-3	276	RO-3	276
			PJ-3	277	PJ-3	277
	1005	1968-1973	NE-3P1	276		
			PJ-K	277		
			PJ-KP	277		
	1006	1968-1973	NE-3P2	276		
	1007	1968-1973				
	1100	1968-1973				
	1501	1970-				
	1100	1974-	CHR-3	276	RO-3	276
			NE-22P2	276		
	1301	1970-1973	NE-3	276	RO-3	276
			NE-3P1	276		
			NE-3P2	276		
	1307	1975-	CHR-3	276	CHR-3	276
			LAS-CR	276	LAS-CR	276
	1308	1975-	NE-22P2	276	NE-22P2	276
			LAS-RC	276	LAS-RC	276
	1309	1978-	NE-22P2	276	NE-22P2	276
	MURENA	1980-				
	150	1975-	LMP-3	276	LMP-3	276
			LMP-3P	276	LMP-3P	276
			LAS-CR	276		
	1510	1975-	LMP-3P	276	LMP-3P	276
	ALPINE	1975-				
	HORIZON	1980-1983				
	MINX	1980-1983				
	OMNI	1980-1983				
	RAPIER	1975-				
	BAGHEERA	1973-	NE-3	276		
			NE-3P1	276		

FOR: PARA:	MODEL MODELO			PAG.		PAG.
TALBOT SIMCA ®			NE-3P2	276		
			PJ-1	277	PJ-1	277
	HORIZON	1977-1979	CHR-3	276	CHR-3	276
			LAS-CR	276	LAS-CR	276
			LAS-RC	276	LAS-RC	276
	HORIZON GL	1977-1979	NE-22P2	276	LMP-3	276
			LAS-RC	276	LAS-RC	276
	MINX	1977-1979			LMP-3P	276
			VA-16	277	VA-16	277
	OMNI	1977-1979			NE-22P2	276
			VA-7	277	VA-7	277
	HORIZON	1984-	CHR-3	276	CHR-3	276
			LAS-BT	276	LAS-BT	276
			PJ-2	277	PJ-2	277
	MINX	1984-	NE-22P2	276	NE-22P2	276
			LAS-TB	276	LAS-TB	276
			PJ-2P	277	PJ-2P	277
	OMNI	1984-	PJ-K	277		
			PJ-KP	277		
	RANCH	1977-	CHR-3	276		
			NE-22P2	276		
			PJ-2	277	PJ-2	277
			PJ-2P	277	PJ-2P	277
	RAPIER	1980-	CHR-3	276	CHR-3	276
	SOLARA	1980-	NE-22P2	276	NE-22P2	276
			LAS-RC	276	LAS-RC	276
			LAS-CR	276	LAS-CR	276
	TAGORA	1980-	NE-33P1	276	NE-33P1	276
	SAMBA	1981-1983	CHR-3	276	CHR-3	276
			NE-22P2	276	NE-22P2	276
			NE-33P1	276	NE-33P1	276
			VA-6	277	VA-6	277
			VA-6P	277	VA-6P	277
	SAMBA	1984-	CHR-3	276	CHR-3	276
			NE-22P2	276	NE-22P2	276
			NE-33P1	276	VA-6	277
					VA-6P	277
			PJ-2	277	PJ-2	277
			PJ-2P	277	PJ-2P	277
			PJ-K	277	PJ-K	277
			PJ-KP	277	PJ-KP	277
	VARIOUS MODELS	-	NE-33P	276	NE-33P	276
			NE-3D	276	NE-3D	276
			RO-1D	277	RO-1D	277
			RO-1D5	276	RO-1D5	276
			RO-1I	277	RO-1I	277
			RO-1IS	276	RO-1IS	276
			RO-2D		RO-2D	
			RO-2I		RO-2I	
			RO-6D	277	RO-6D	277
			RO-6I	277	RO-6I	277
TATA ®	INDICA	2000-	TAT-1D	277	TAT-1D	277
			TAT-1DP	277	TAT-1DP	277
	VARIOUS MODELS	-	TAT-2DP	277	TAT-2DP	277

FOR: PARA:	MODEL MODELO			PAG.		PAG.
TOYOTA ®	3 DR LIFT B.	1988-1989	TOYO-12	279	TOYO-12	279
	4 RUNNER	1988-1989	TOYO-12P1	279	TOYO-12P1	279
	CELICA	1988-1989	TOYO-8	278	TOYO-8	278
	COROLLA	1988-1989	TOYO-8P	278	TOYO-8P	278
	MR2	1989-1990				
	SUPRA EFI SR	1988-1989				
	TERCEL	1989-				
	4 RUNNER	1970-1986	TOYO-12	279	TOYO-12	279
	L.CRUISER	1970-1986	TOYO-12P1	279	TOYO-12P1	279
			TOYO-2	278	TOYO-2	278
			TOYO-K1	278	TOYO-K1	278
			TOYO-K1P	278	TOYO-K1P	278
	4 RUNNER	1986-1988	TOYO-16	280	TOYO-16	280
	CAMRY	1990-1991	TOYO-16P	280	TOYO-16P	280
	DYNA	1990-	TOYO-16P1	280	TOYO-16P1	280
	L.CRUISER	1986-1989	TOYO-5	278	TOYO-5	278
	LITEACE	1990-	TOYO-5P	278	TOYO-5P	278
	RUNNER	1986-1989	TOYO-5P1	278	TOYO-5P1	278
	STARLET	1990-1997				
	VX TURBO	1986-1989				

Automóvil. Camioneta
Automobila. Kamioneta
Voiture. Camionnette

Auto. Kleintransporter
Automóvil. Camioneta
Automóvil. Camioneta

FOR: PARA:	MODEL MODELO			PAG.		PAG.
TOYOTA®	CAMRY	1984-1989	TOYO-13	279	TOYO-13	279
			TOYO-13P1	279	TOYO-13P1	279
			TOYO-28P	281	TOYO-28P	281
	CAMRY GL	1984-	TOYO-3	278	TOYO-3	278
	CAMRY GLI	1984-	TOYO-3P	278	TOYO-3P	278
	COROLLA 4DR	1986-1996	TOYO-8	278	TOYO-8	278
			TOYO-8P	278	TOYO-8P	278
	CARINA	1972-1982	TOYO-14	278	TOYO-14	278
	CELICA	1972-1982	TOYO-14P	278	TOYO-14P	278
	COROLLA	1972-1974	TOYO-K1	278	TOYO-K1	278
	CORONA	1972-1974	TOYO-K1P	278	TOYO-K1P	278
	CROWN	1972-1982				
	HIACE	1975-1982				
	HILUX	1973-1978				
	MARK II	1972-1982				
	PUBLICA	1972-1974				
	STARLET	1972-1982				
	CARINA	1983-1985	TOYO-3	278	TOYO-3	278
	COROLLA	1975-1982	TOYO-3P	278	TOYO-3P	278
	CORONA	1983-1985	TOYO-8	278	TOYO-8	278
	CORSA	1983-1985	TOYO-8P	278	TOYO-8P	278
	CRESSIDA	1983-1985				
	CRESTA	1983-1985				
	CROWN	1983-1985				
	MARK II	1983-1985				
	MR2	1983-1985				
	SPRINTER	1983-1985				
	TERCEL	1983-1985				
	CARINA	1985-1986	TOYO-3	278	TOYO-3	278
	CORONA	1985-1986	TOYO-3P	278	TOYO-3P	278
	SPRINTER	1985-1986				
	TERCEL 4WD	1985-1986				
	CARINA	1994-	TOYO-19P	280	TOYO-19P	280
	CELICA	1983-1985	TOYO-12	279	TOYO-12	279
			TOYO-12D	279	TOYO-12D	279
			TOYO-12P1	279	TOYO-12P1	279
			TOYO-22	280	TOYO-22	280
			TOYO-22D	280	TOYO-22D	280
			TOYO-3	278	TOYO-3	278
			TOYO-3P	278	TOYO-3P	278
			TOYO-8	278	TOYO-8	278
			TOYO-8P	278	TOYO-8P	278
			TOYO-K1	278	TOYO-K1	278
			TOYO-K1P	278	TOYO-K1P	278
	CELICA	1986-1988	TOYO-10	279	TOYO-10	279
	COROLLA ST	1988-1989	TOYO-10P	279	TOYO-10P	279
	TERCEL	1987-1988	TOYO-11	279	TOYO-11	279
			TOYO-11P	279	TOYO-11P	279
	CELICA	1990-1995	TOYO-10	279	TOYO-10	279
			TOYO-20D	280	TOYO-20D	280
			TOYO-10P	279	TOYO-10P	279
			TOYO-10P1	279	TOYO-10P1	279
			TOYO-11	279	TOYO-11	279
			TOYO-11P	279	TOYO-11P	279
			TOYO-11P1	279	TOYO-11P1	279
			TOYO-20D	280	TOYO-20D	280
			TOYO-9	279	TOYO-9	279

FOR: PARA:	MODEL MODELO			PAG.		PAG.
TOYOTA®			TOYO-9P	279	TOYO-9P	279
			TOYO-9P1	279	TOYO-9P1	279
	CELICA 4WD	1990-1991	TOYO-10	279	TOYO-10	279
	MR2	1990-1991	TOYO-10P	279	TOYO-10P	279
	PREVIA	1993-1997	TOYO-10P1	279	TOYO-10P1	279
			TOYO-11	279	TOYO-11	279
			TOYO-11P	279	TOYO-11P	279
			TOYO-11P1	279	TOYO-11P1	279
	CELICA COUPE	1991-1994	TOYO-37D	281	TOYO-37D	281
	CELICA LIFT.	1991-1996	TOYO-10	279	TOYO-10	279
			TOYO-10P1	279	TOYO-10P1	279
	CELICA SUPRA	1982-1985	TOYO-4	278	TOYO-4	278
			TOYO-4P	278	TOYO-4P	278
	COROLLA	-19-	TOYO-8IP	278	TOYO-8IP	278
	COROLLA	1983-1987	TOYO-12	279	TOYO-12	279
	TERCEL	1985-1987	TOYO-12P1	279	TOYO-12P1	279
			TOYO-22	280	TOYO-22	280
			TOYO-22D	280	TOYO-22D	280
			TOYO-K1	278	TOYO-K1	278
			TOYO-K1P	278	TOYO-K1P	278
	COROLLA 5	1972-1976	TOYO-2	278	TOYO-2	278
			TOYO-4	278	TOYO-4	278
			TOYO-4P	278	TOYO-4P	278
	COROLLA DX	1985-1996	TOYO-23	280	TOYO-23	280
			TOYO-23P	280	TOYO-23P	280
	COROLLA GT	1985-1996	TOYO-8	278	TOYO-8	278
			TOYO-8P	278	TOYO-8P	278
	COROLLA SM	1973-1978	TOYO-14	278	TOYO-14	278
			TOYO-14P	278	TOYO-14P	278
			TOYO-4	278	TOYO-4	278
			TOYO-4P	278	TOYO-4P	278
			TOYO-K1	278	TOYO-K1	278
			TOYO-K1P	278	TOYO-K1P	278
	COROLLA SW	1993-1996	TOYO-17	280	TOYO-17	280
			TOYO-17P	280	TOYO-17P	280
	CRESSIDA	1977-1978	TOYO-23	280	TOYO-23	280
	CRESTA	1977-1978	TOYO-23P	280	TOYO-23P	280
	CRESSIDA	1984-1987	TOYO-28P	281	TOYO-28P	281
	CRESSIDA	1985-1987	TOYO-13	279	TOYO-13	279
			TOYO-13P1	279	TOYO-13P1	279
	FX 16	1987-1988	TOYO-K1	278	TOYO-K1	278
			TOYO-K1P	278	TOYO-K1P	278
	HDJ 80	1991-	TOYO-18P	280	TOYO-18P	280
	L.CRUISER	1991-				
	HILUX 4x4	1995-	TOYO-20D	280	TOYO-20D	280
	MR2	1991-1997	TOYO-9	279	TOYO-9	279
			TOYO-9P	279	TOYO-9P	279
			TOYO-9P1	279	TOYO-9P1	279
	PASEO	1991-1997	TOYO-10	279	TOYO-10	279
			TOYO-10P	279	TOYO-10P	279
			TOYO-10P1	279	TOYO-10P1	279
	PROACE	2013-2016	KRCHU-HCA	367	KRCHU-HCA	367
	STARLET	1984-1990	TOYO-K1	278	TOYO-K1	278
			TOYO-K1P	278	TOYO-K1P	278
	VARIOS	-1969	TOYO-25	280	TOYO-25	280
	VARIOS	1970-	TOYO-29	281	TOYO-29	281
	VARIOUS BRANDS	-	TOYO-9P2	279	TOYO-9P2	279

FOR: PARA:	MODEL MODELO			PAG.		PAG.
TOYOTA®	VARIOUS MODELS		MIT-2DP	278	MIT-2DP	278
			TOYO-12DP1	279	TOYO-12DP1	279
			TOYO-15DP	279	TOYO-15DP	279
			TOYO-15P10	279	TOYO-15P10	279
			TOYO-24	280	TOYO-24	280
			TOYO-26	280	TOYO-26	280
			TOYO-30P1	281	TOYO-30P1	281
			TOYO-40	281	TOYO-40	281
			TOYO-40D	281	TOYO-40D	281
			TOYO-41P	280	TOYO-41P	280
			TOYO-6	278	TOYO-6	278
			MIT-2D	278	MIT-2D	278
	VARIOUS MODELS	1983-	MIT-2D	278	MIT-2D	278
TOYOTA (AUSTRALIA)®	CAMRY	2011-2015	KRCTOYO-15	367	KRCTOYO-15	367
	COROLLA	2010-2013				
	HIACE	2010-2012				
TOYOTA (USA)®	4RUNNER	1999-2002	KRCTOYO-15	367	KRCTOYO-15	367
	4RUNNER	2010-2016				
	4RUNNER USA	2002-2009				
	AVALON	2002-2004				
	CAMRY	2002-2006				
	CAMRY	2006-2011				
	CAMRY	2015-2016				
	COROLLA	2003-2005				
	COROLLA	2005-2008				
	COROLLA	2009-2010				
	COROLLA	2014-2016				
	FJ CRUISER	2007-2008				
	FJ CRUISER	2008-2009				
	FJ CRUISER	2010-2010				
	FJ CRUISER	2011-2014				
	HIGHLANDER	2001-2003				
	HIGHLANDER	2004-2007				
	LAND CRUISER	2006-2007				
	LELICA	2004-2005				
	MATRIX	2004-2008				
	PRIUS	2001-2003				
	RAV4	2001-2003				
	RAV4	2004-2005				
	RAV4	2006-2010				
	RAV4	2010-2012				
	SEQUOIA	2001-2003				
	SEQUOIA	2004-2007				
	SIENNA	1999-2003				
	SIENNA	2001-2003				
	SIENNA	2002-2003				
	THAILAND	2005-2009				
	TUNDRA	2004-2005				
	TUNDRA	2006-2006				
	YARIS	2006-2010				
	YARIS	2007-2011				
	YARIS	2012-2014				
TRABANT®	TODOS	-19-	DOB-1	281	DOB-1	281

FOR: PARA:	MODEL MODELO			PAG.		PAG.
TRABANT®			DOB-1D	281	DOB-1D	281
			DOB-2	281	DOB-2	281
			DOB-2D	281	DOB-2D	281
			DOB-3	281	DOB-3	281
			DOB-3D	281	DOB-3D	281
TRIUMPH®	ACCLAIM	1981-	HOND-1	281	HOND-1	281
			HOND-1P	281	HOND-1P	281
			HOND-2	281	HOND-2	281
			HOND-2P	281	HOND-2P	281
	DOLOMITE	1973-	UN-NH	282	UN-FS	282
	TOLEDO	1973-	UN-NHP			
	GT6 MK3	-19-	FO-FR	281	UN-NH	282
			FO-FRP	281	UN-NHP	
			UN-NH	282		
			UN-NHP			
			WAS-2P	282		
	GTX MK3	1				

Automóvil. Camioneta
Automobila. Kamioneta
Voiture. Camionnette

Auto. Kleintransporter
Automóvil. Camioneta
Automóvil. Camioneta

FOR: PARA:	MODEL MODELO			PAG.		PAG.
VARIOUS BRANDS				BAS-3 150	BAS-2I 150	
				BL-5 150	BAS-3 150	
				BL-5D 150	BL-5 150	
				BL-6 150	BL-5D 150	
				BL-6D 150	BL-6 150	
				BUR-6 150	BL-6D 150	
				CAM-1D 150	BUR-6 150	
				CHR-6 150	CAM-1D 150	
				CHR-6D 150	CHR-6 150	
				CN-1D 150	CHR-6D 150	
				GH-1 151	CN-1D 150	
				GH-2 151	GH-1 151	
				GH-3 151	GH-2 151	
				GH-PS 151	GH-3 151	
				HU-NW 151	GH-PS 151	
				HU-P 151	HU-NW 151	
				KAM-1 151	HU-P 151	
				KAM-ID 151	KAM-1 151	
				MERI-ID 151	KAM-ID 151	
				MERI-IDP 151	MERI-ID 151	
				MERI-IP1 152	MERI-IDP 151	
				MERI-2DP 151	MERI-IP1 152	
				MOD-IDP 152	MERI-2DP 151	
				NE-1D 152	MOD-IDP 152	
				NE-IDP 152	NE-1D 152	
				NE-2 152	NE-IDP 152	
				NE-27 152	NE-2 152	
				NE-30 152	NE-27 152	
				NE-30P 152	NE-30 152	
				NE-31 152	NE-30P 152	
				NE-31P 152	NE-31 152	
				NE-32 152	NE-31P 152	
				NE-32P 152	NE-32 152	
				NE-44P 152	NE-32P 152	
				NE-48 152	NE-44P 152	
				NE-49 152	NE-48 152	
				NE-54P 153	NE-49 152	
				NE-57 153	NE-54P 153	
				NE-63D 153	NE-57 153	
				OP-1 153	NE-63D 153	
				OP-DD 153	OP-1 153	
				PRE-2I 153	OP-DD 153	
				SIM-1200 153	PRE-2I 153	
				SIX-5P 153	SIM-1200 153	
				STR-3 153	SIX-5P 153	
				TAP-1P 154	STR-3 153	
				TAP-2 154	TAP-1P 154	
				TIT-7D 154	TAP-2 154	
				TOYO-30P1 154	TIT-7D 154	
				TOYO-6 154	TOYO-30P1 154	
				TRL-1P 154	TOYO-6 154	
				UN-NC 154	TRL-1P 154	
				VA-3 154	UN-NC 154	
				VA-3I 154	VA-3 154	
				VO-VA 154	VA-3I 154	
				VO-VAP 154	VO-VA 154	
				WAS-10DP 154	VO-VAP 154	



FOR: PARA:	MODEL MODELO			PAG.		PAG.
VARIOUS BRANDS				WAS-10P 154	WAS-10DP 154	
				WAS-3 154	WAS-10P 154	
				YA-27 154	WAS-3 154	
				YA-27D 154	YA-27 154	
				ZA-5P 155	YA-27D 154	
					ZA-5P 155	
	VARIOUS MODELS	-2020		BL-3 150	BL-3 150	
				BL-4 150	BL-4 150	
				BL-4D 150	BL-4D 150	
				LAS-5 151	LAS-5 151	
				LAS-5D 151	LAS-5D 151	
				NE-60CI 358	NE-60CI 358	
VAUXHALL ®	ASTRA	1975-1979	OP-J	283	OP-J	283
	CHEVRETTE	1975-1979	OP-JP	283	OP-JP	283
	ASTRA	1984-1995	OP-D	283	OP-D	283
	ASTRAMAX	1984-	OP-DP	283	OP-DP	283
	BELMONT	1984-	OP-S	283	OP-S	283
	NOVA	1984-	OP-SP	283	OP-SP	283
	CARLTON	1978-1981	OP-R	283	OP-R	283
	VICEROY	1978-1989	OP-RP	283	OP-RP	283
			OP-T	283	OP-T	283
			OP-TP	283	OP-TP	283
	CARLTON	1982-	OP-WHP	283	OP-WHP	283
	CAVALIER	1982-	OP-WYP	283	OP-WYP	283
	SENATOR	1982-				
	CAVALIER	1975-1981	OP-AB	282	OP-AB	282
			OP-ABP	282	OP-ABP	282
			OP-BA	282	OP-BA	282
			OP-BAP	283	OP-BAP	283
			OP-J	283	OP-J	283
			OP-JP	283	OP-JP	283
	FIRENZA	-19-	LF-RO	282	LF-6 282	
			LF-ROP	282		
	ROYALE	1984-	OP-D	283	OP-D	283
			OP-DP	283	OP-DP	283
			OP-S	283	OP-S	283
			OP-SP	283	OP-SP	283
	GAZ 024	-19-	VOL-1		VOL-1	
VOLGA ®			VOL-1P	283	VOL-1P	283
	GAZ 029	-19-	NE-3	283	VOL-1	283
			NE-3P	283	VOL-1P	283
			NE-3P2	283	VOL-2	284
					VOL-2D	284
					VOL-3	284
	GAZ 3110	-19-	NE-3	283	VOL-1	283
			NE-3P	283	VOL-1P	283
			NE-3P2	283	VOL-4	284
					VOL-5P	284
	VARIOUS MODELS	-	NE-3D	283	NE-3D	283
1500	-19-				CHR-8	
VOLKSWAGEN ®	1303 CABRIO	1970-	HU-SU	285	VO-M	286



FOR: PARA:	MODEL MODELO			PAG.		PAG.
VOLKSWAGEN ®					VO-MP	286
	1500	-19-	CHR-11	284	CHR-11	284
			CHR-11P	284	CHR-11P	284
	1500	1970-1972	VO-K	286		
	1600	1970-1972				
	411	1970-1972				
	412	1970-1972				
	BRASILIA	1970-1972				
	411	1973-1974	VO-VB	286	VO-VB	286
	412	1973-1974	VO-VBP	286	VO-VBP	286
	BRASILIA	1973-1974				
	IGALA	1973-1974				
	ALL STAR	1991-	VO-2	286	VO-2	286
	CALIFORNIA	1991-	VO-2P	286	VO-2P	286
	CLUB VAN	1991-				
	SINCRO	1991-				
	TRANSPORTER	1991-1995				
	AMAROK	2011-2015	KRCHU-HAA	367	KRCHU-HAA	367
	BEETLE	1999-2003				
	BEETLE	2002-2005				
	BEETLE	2005-2010				
	BEETLE	2012-2013				
	BORA	1998-2000				
	BORA	1999-2001				
	BORA	2002-2005				
	BORA	2011-2013				
	CADDY	2004-2011				
	CADDY	2010-				
	CADDY	2011-2013				
	EOS	2006-2011				
	EOS	2009-2013				
	GOL	2010-2013				
	GOLF	1998-2001				
	GOLF	2002-2004				
	GOLF	2004-2009				
	GOLF	2009-2011				
	GOLF	2011-2013				
	GOLF PLUS	2005-2009				
	GOLF PLUS	2009-2011				
	GOLF PLUS	2011-2013				
	LAVIDA	2011-2016				
	MPV TRANSPORTER	2004-2010				
	MPV TRANSPORTER	2010-2014				
	MPV TRANSPORTER	2012-				
	NOUVELLE COCCINELLE	2012-2013				
	PASSAT	1997-2000				
	PASSAT	2001-2005				
	PASSAT	2011-2016				
	POLO	2002-2009				
	POLO	2009-2010				
	POLO	2010-2013				
	SAGITAR	2011-2017				
	SCIROCCO	2009-2010				
	SCIROCCO	2011-2013				
	SHARAN	2011-				



FOR: PARA:	MODEL MODELO			PAG.		PAG.
VOLKSWAGEN ®	SHARAN	2011-2013				
	TIGUAN	2008-2011				
	TIGUAN	2010-2013				
	TIGUAN	2011-2016				
	TIGUAN	2012-				
	TOURAN	2003-2010				
	TOURAN	2010-2014				
	UP	2012-				
	BEETLE	1970-1978	VO-M	286	VO-M	286
			HU-SU	285	HU-SU	285
	EL VOLKSWAGE	1970-1978	VO-MP	286	VO-MP	286
	ESCARABAJA	1970-1978				
	FUSCA	1970-1978				
	CABRIOLET	1975-1981	VO-VB	286	VO-VB	286
			VO-VBP	286	VO-VBP	286
			BL-2	284	BL-2	284
			FO-PN	285	FO-PN	285
			HU-SU	285	HU-SU	285
	CADDY	-19-	AU-1	284	AU-1	284
			AU-HV	284	AU-HV	284
			AU-HVP	284	AU-HVP	284
			VO-HV	286	VO-HV	286
			VO-HVP	286	VO-HVP	286
	CORRADO	1988-	AU-AN	284	AU-AN	284
			VO-2	286	VO-2	286
	GOLF	1988-1990	AU-ANP	284	AU-ANP	284
			VO-2P	286	VO-2P	286
	JETTA ATLAN.	1988-	HU-AN	285	HU-AN	285
	PASSAT	1988-1995	VO-2	286	VO-2	286
	VENTO	1992-1995	VO-2P	286	VO-2P	286
	CRAFTER	2006-2013	KRCME-7	367	KRCME-7	367
	DERBY AMAZON	1977-1980	VO-VB	286	VO-VB	286
			BL-1I	284	BL-1I	284
	FAMILCAR	1977-1980	VO-VBP	286	VO-VBP	286
			PJ-1	285	PJ-1	285
	GOLF	1977-1980	PJ-2	285	PJ-2	285
	PASSAT	1977-1980	PJ-2P	285	PJ-2P	285
	POLO	1977-1980				
	DERBY AMAZON	1981-1982	AU-1	284	AU-1	284
	GOLF	1981-1982	AU-HV	284	AU-HV	284
	GOLF CABRIO	1981-1984	AU-HVP	284	AU-HVP	284
	JETTA ATLAN.	1981-1984	VO-HV	286	VO-HV	286
			BL-2	284	BL-2	284
	PASSAT	1981-1984	VO-HVP	286	VO-HVP	286
	SANTANA	1981-1982	VO-VB	286	VO-VB	286
	SCIROCCO	1981-1982	VO-VBP	286	VO-VBP	286
	DERBY AMAZON	1985-1987	AU-1	284	AU-1	284
	GOLF	1985-1987	AU-HV	284	AU-HV	284
	JETTA ATLAN.	1985-1987	AU-HVP	284	AU-HVP	284
	PASSAT	1985-1987	VO-HV	286	VO-HV	286
			BL-1I	284	BL-1I	284
	POLO	1985-1991	VO-HVP	286	VO-HVP	286
	SCIROCCO	1985-1987	VO-VB	286	VO-VB	286
			FO-PN	285	FO-PN	285
			VO-VBP	286	VO-VBP	286
			VO-HV	286	VO-HV	286
	GACEL	-19-	VO-FHP	286	VO-FHP	286



Automóvil. Camioneta
Automobila. Kamioneta
Voiture. Camionnette

Auto. Kleintransporter
Automóvil. Camioneta
Automóvil. Camioneta

FOR: PARA:	MODEL MODELO			PAG.		PAG.
VOLKSWAGEN ®	SENDA	-19-				
	GOL	-19-	VO-FHP	286	VO-FHP	286
	GOLF	1975-1977	VO-VB	286	HU-SU	285
			VO-VBP	286	VO-VB	286
					VO-VBP	286
	GOLF	1987-1988	VO-2	286	VO-2	286
			VO-2P	286	VO-2P	286
			VO-AHP	286	VO-AHP	286
	GOLF	1991-1995	AU-AN	284	AU-AN	284
			AU-ANP	284	AU-ANP	284
			HU-AN	285	HU-AN	285
			VO-2	286	VO-2	286
			VO-2P	286	VO-2P	286
	GOLF	2013-	HU-HAAC4	358	HU-HAAC4	358
	K 70	1970-1973	FO-PN	285	FO-PN	285
	K 70 LS	1970-1973	VO-VB	286	VO-VB	286
			VO-VBP	286	VO-VBP	286
	LT 28D	1970-1979	VO-R	286	VO-R	286
			HU-SU	285	HU-SU	285
	LT 31	1970-1979	VO-RP	286	VO-RP	286
	TL 31	1970-1979				
	TL 45	1970-1979				
	TL 50	1970-1979				
	MODELOS	1966-1969	FO-D	284	VO-L	286
			VO-L	286		
			HU-SU	285	HU-SU	285
	PASSAT	1973-	VO-VB	286	VO-VB	286
			VO-VBP	286	VO-VBP	286
	PASSAT FAM.	1973-1976	VO-R	286	VO-R	286
			VO-RP	286	VO-RP	286
	POLARA	-19-	CHR-11	284	CHR-11	284
	POLO	1975-1976	VO-VB	286	VO-VB	286
			VO-VBP	286	VO-VBP	286
	POLO	1981-1982	AU-1	284	AU-1	284
			AU-HV	284	AU-HV	284
			AU-HVP	284	AU-HVP	284
			VO-HV	286	VO-HV	286
			VO-HVP	286	VO-HVP	286
			BL-11	284	BL-11	284
	POLO	1991-1995	VO-2	286	VO-2	286
			VO-2P	286	VO-2P	286
			BL-2	284	BL-2	284
	SCIROCCO	1975-1981	VO-VB	286	VO-VB	286
			VO-VBP	286	VO-VBP	286
			BL-11	284	BL-11	284
			PJ-2	285	PJ-2	285
			PJ-2P	285	PJ-2P	285
	TARO NISSAN	1989-	TOYO-20D	285	TOYO-20D	285
			TOYO-9	285	TOYO-9	285
			TOYO-9P	285	TOYO-9P	285
			TOYO-9P1	285	TOYO-9P1	285
	TL 31	1980-	VO-N	286	VO-N	286
	TL 35	1980-	VO-NP	286	VO-NP	286
	TL 45	1980-				
	TL 50	1980-				
	TRANSPORTER	1980-1991				

FOR: PARA:	MODEL MODELO			PAG.		PAG.
VOLKSWAGEN ®	VAGON	1980-				
	VARIOUS MODELS	-	HU-HAAC5	358	HU-HAAC5	358
			HU-HAAP1	285	HU-HAAP1	285
			HU-NAAC2	358	HU-NAAC2	358
			SE-AN	285	SE-AN	285
			VO-KP	286	VO-KP	286
			VW-K70	286	VW-K70	286
	VARIOUS MODELS	-2020	HU-HAAC1	358	HU-HAAC1	358
			HU-HAAC2	358	HU-HAAC2	358
			HU-HAAC3	358	HU-HAAC3	358
VOLKSWAGEN (ARGEN.) ®					CHR-8P	286
	1500	1980-	CHR-12	287	WAS-1	288
	1800	1980-				
	1800 RURAL	1980-	CHR-11P	287	CHR-11P	287
	GACEL	-19-	VO-FHP1	287	VO-FHP1	287
			GAS-1	287	GAS-1	287
	GOL	-1995	VO-FHP1	287	VO-FHP1	287
			LI-ID		LI-ID	
			VO-VB	287	VO-VB	287
			VO-VBP	287	VO-VBP	287
	GOL	1996-	VO-2DP	287	VO-2DP	287
			VO-2DP1	287	VO-2DP1	287
			VO-6D	287	VO-6D	287
	GOL	1997-	VO-8P	287	VO-8P	287
			VO-8P1	287	VO-8P1	287
	KOMBI	-19-	VO-R	287	VO-R	287
			VO-RP	287	VO-RP	287
			GAS-1	287	GAS-1	287
	POINTER	-19-	VO-5P	287	VO-5P	287
	SAVEIRO	-19-	VO-HV	287	VO-HV	287
			VO-HVP	287	VO-HVP	287
			VO-VB	287	VO-VB	287
			VO-VBP	287	VO-VBP	287
			CLI-1D	287	CLI-1D	287
			VO-6D	287	VO-6D	287
	SENDA	-19-	VO-HV	287	VO-HV	287
			VO-HVP	287	VO-HVP	287
			CLI-1D	287	CLI-1D	287
			GAS-1	287	GAS-1	287
	VARIOUS MODELS	-	VO-HVP1	287	VO-HVP1	287
	PASSAT	2010-2013	KRCHU-HAA		KRCHU-HAA	
VOLKSWAGEN (AUS.) ®	VENTO	2010-				
	FOX	1975-1976	VO-VB		VO-VB	
			AU-W		AU-W	
VOLKSWAGEN (BRASIL.) ®	GOL	1975-1976	VO-VBP	289	VO-VBP	289
	FOX	1977-1980	VO-VB	289	VO-VB	289
			BL-11	288	BL-11	288
	GOL	1977-1980	VO-VBP	289	VO-VBP	289
			PJ-1	288	PJ-1	288
			PJ-2	288	PJ-2	288
			PJ-2P	289	PJ-2P	289

FOR: PARA:	MODEL MODELO			PAG.		PAG.
VOLKSWAGEN (BRASIL.) ®	PARATI	1977-1980	PJ-2	288	PJ-2	288
	QUANTUM	1977-1980	PJ-2P	289	PJ-2P	289
	FOX	1981-1982	AU-1	288	AU-1	288
	GOL	1981-1982	AU-HV	288	AU-HV	288
			AU-HVP	288	AU-HVP	288
			VO-HV	289	VO-HV	289
			VO-HVP	289	VO-HVP	289
	FOX	1985-1991	AU-1	288	AU-1	288
	GOL	1985-1991	AU-HV	288	AU-HV	288
	PARATI	1985-1987	AU-HVP	288	AU-HVP	288
	QUANTUM	1985-1987	VO-HV	289	VO-HV	289
			VO-HVP	289	VO-HVP	289
			VO-VB	289	VO-VB	289
			VO-VBP	289	VO-VBP	289
			BL-11	288	BL-11	288
			BL-2	288	BL-2	288
			FO-PN	288	FO-PN	288
	FOX	1991-	VO-2	289	VO-2	289
			BL-2	288	BL-2	288
	GOL	1991-	VO-2P	289	VO-2P	289
	GOL	1991-1997	VO-2P	289	VO-2P	289
			BL-2	288	BL-2	288
	GOL	1998-	VO-2DP1	289	VO-2DP1	289
	VARIOS	1996-	VO-2P1	289	VO-2P1	289
			VO-8P1	289	VO-8P1	289
	PARATI	1973-	VO-VB	289	VO-VB	289
			FO-PN	288	FO-PN	288
	QUANTUM	1973-	VO-VBP	289	VO-VBP	289
	PARATI	1981-1984	AU-1	288	AU-1	288
	QUANTUM	1981-1984	AU-HV	288	AU-HV	288
	SANTANA	1981-1982	AU-HVP	288	AU-HVP	288
			VO-HV	289	VO-HV	289
			VO-HVP	289	VO-HVP	289
			VO-VB	289	VO-VB	289
			VO-VBP	289	VO-VBP	289
			BL-2	288	BL-2	288
	PARATI	1988-	AU-AN	288	AU-AN	288
	QUANTUM	1988-	AU-ANP	288	AU-ANP	288
			HU-AN	288	HU-AN	288
			VO-2	289	VO-2	289
			VO-2P	289	VO-2P	289
VOLKSWAGEN (CHINA.) ®	SHANGHAI	1973-	VO-VB	290	VO-VB	290
			VO-VBP	290	VO-VBP	290
	SHANGHAI	1977-1980	VO-VB	290	VO-VB	290
			VO-VBP	290	VO-VBP	290
			PJ-1	290	PJ-1	290
			PJ-2	290	PJ-2	290
			PJ-2P	290	PJ-2P	290
	SHANGHAI	1981-1984	AU-1	289	AU-1	289
			AU-HV	289	AU-HV	289
			AU-HVP	289	AU-HVP	289
			VO-HV	290	VO-HV	290
			VO-HVP	290	VO-HVP	290
			VO-VB	290	VO-VB	290
			VO-VBP	290	VO-VBP	290

FOR: PARA:	MODEL MODELO			PAG.		PAG.
VOLKSWAGEN (CHINA.) ®					BL-2	290
					BL-2	290
	SHANGHAI	1985-1987	AU-1	289	AU-1	289
			AU-HV	289	AU-HV	289
			AU-HVP	289	AU-HVP	289
			VO-HV	290	VO-HV	290
			VO-HVP	290	VO-HVP	290
			VO-VB	290	VO-VB	290
			VO-VBP	290	VO-VBP	290
	SHANGHAI	1988-	AU-AN	289	AU-AN	289
			AU-ANP	289	AU-ANP	289
			HU-AN	290	HU-AN	290
			VO-2	290	VO-2	290
			VO-2P	290	VO-2P	290
VOLKSWAGEN (MEXICO.) ®	ESCARABAJOS	-19-	VO-M	291	VO-M	291
			VO-MP	291	VO-MP	291
			HU-SU	291	HU-SU	291
VOLKSWAGEN (USA.) ®	BEETLE	1998-1999	KRCHU-HAA	367	KRCHU-HAA	367
	BEETLE	2000-2001				
	BEETLE	2002-2010				
	EOS	2007-2013				

Automóvil. Camioneta
Automobila. Kamioneta
Voiture. Camionnette

Auto. Kleintransporter
Automóvil. Camioneta
Automóvil. Camioneta

Camión
Kamioi
Camions

Lkw
Camión
Ciężarowych

FOR: PARA:	MODEL MODELO	CCCCC	PAG.	PAG.
VOLVO	262		1977-1978	
	264		1977-1978	
	265		1977-1978	
	240		1978-1984	NE-12 292 NE-12 292
	242		1978-1983	NE-12P 292 NE-12P 292
	244		1978-1983	
	245		1978-1983	
	262		1978-1983	
	264		1978-1983	
	265		1978-1983	
	240		1984-1985	NE-12 292 NE-12 292
				NE-12P 292 NE-12P 292
				NE-18 292 NE-18 292
				NE-18P 292 NE-18P 292
	340		1976-1984	HU-DF 291 AKS-1 291
	343		1976-1984	HU-DFP1 291
	345		1976-1984	HU-DFP1
	360		1976-1984	
	340		1985-1986	HU-DF 291 HU-DF 291
	360		1985-1986	HU-DFP1 291 HU-DFP1 291
				HU-DFP1 HU-DFP1
	440		1987-	HU-DHP 291 HU-DHP 291
	460		1987-	HU-DNP 291 HU-DNP 291
	480		1987-	
	740		1986-1991	NE-12 292 NE-12 292
	760		1984-1987	NE-12P 292 NE-12P 292
	780		1986-1991	NE-18 292 NE-18 292
	940		1991-1996	NE-18P 292 NE-18P 292
	760		1991-	NE-40 292 NE-40 292
	762		1991-	NE-40P 292 NE-40P 292
	764		1991-	NE-41P 292 NE-41P 292
	765		1991-	
	960		1991-1996	
	850		1991-1996	NE-40 292 NE-40 292
				NE-40P 292 NE-40P 292
	AMAZON 140		-1973	NE-13 292 UN-4 291
				NE-56 292 UN-FP 292
				UN-FS 292
	FH 12		1997-	HU-DHP 291 HU-DHP 291
	PV AMAZON		-19-	AS-11 291 HUD-1 291
				AS-24 291
WARTBURG	MODELOS		-19-	DOB-1 292 DOB-1 292
				DOB-1D 292 DOB-1D 292
				DOB-2 292 DOB-2 292
				DOB-2D 292 DOB-2D 292
				DOB-3 293 DOB-3 293
				DOB-3D 293 DOB-3D 293
YAMAHA	VARIOUS MODELS		-	YAMA-10D 293 YAMA-10D 293
				YAMA-10I 293 YAMA-10I 293
				YAMA-11D 293 YAMA-11D 293
				YAMA-11I 293 YAMA-11I 293
				YAMA-12D 293 YAMA-12D 293
				YAMA-12I 293 YAMA-12I 293
				YAMA-1D 293 YAMA-1D 293
				YAMA-1I 293 YAMA-1I 293
				YAMA-20DP 293 YAMA-20DP 293

FOR: PARA:	MODEL MODELO	CCCCC	PAG.	PAG.	
YAMAHA			YAMA-2D 293	YAMA-2D 293	
			YAMA-2I 293	YAMA-2I 293	
			YAMA-4D 293	YAMA-4D 293	
			YAMA-6D 293	YAMA-6D 293	
			YAMA-6I 293	YAMA-6I 293	
			YAMA-7D 293	YAMA-7D 293	
			YAMA-7I 293	YAMA-7I 293	
			YAMA-8D 293	YAMA-8D 293	
			YAMA-8I 293	YAMA-8I 293	
YUGO-ZASTAVA	101		1971-1982	FO-FR 294 IMS-3 294	
	311		1971-1982	FO-FRP 294 IMS-3P 294	
	411		1971-1982		IMS-5 294
	413		1971-1982		IMS-5P 294
	511		1971-1982		
	513		1971-1982		
	KORAL		1987-	FI-6I 294 FI-3D 293	
	YUGO 45		1987-	FI-6IP3 294 FI-3DP 293	
	YUGO 55		1987-		FI-3DP5 294
	YUGO 65		1987-		
	YUGO 45		-19-	CL-7P 293 CL-7P 293	
				FI-6IP 294 FI-6IP 294	
	YUGO 45		1982-1984	FI-6I 294 FI-6I 294	
	YUGO 55		1982-1984	FI-6IP3 294 FI-6IP3 294	
				FO-E-TC 294 IMS-3 294	
				FO-E-TCP 294 IMS-3P 294	
				FO-FR 294 IMS-5 294	
				FO-FRP 294 IMS-5P 294	
				SIP-1 294	
	YUGO 45		1985-1986	FI-6I 294 YU-1D 294	
	YUGO 55		1985-1986	FI-6IP3 294	
	YUGO 65		1985-1986		
	YUGO 45		1986-1987	FI-6I 294 IMS-3 294	
	YUGO 55		1986-1987	FI-6IP3 294 IMS-3P 294	
	YUGO 65		1986-1987		IMS-5 294
				IMS-5P 294	
ZAZ	966		-19-	NE-3 294 VOL-3 295	
	968 A		-19-	NE-3P 295	
	968 M		-19-	NE-3P1 295	
				NE-3P2 295	
	TAVRIA		-19-	NE-3 294 AF-19 294	
				NE-3P 295 AF-19P 294	
				NE-3P1 295	
				NE-3P2 295	
	VARIOUS MODELS		-	NE-3D 294 NE-3D 294	

FOR: PARA:	MODEL MODELO	CCCCC	PAG.	PAG.	
ASTRA	BM 64.26		-19-	AF-7I 296 IMS-3 296	
	BM 64.30		-19-	AF-7IP 296 IMS-3P 296	
	BM 64.36		-19-	AF-8D 296 IMS-5 296	
	BM 66.30		-19-	AF-8DP 296 IMS-5P 296	
	BM 66.36		-19-	AF-8I 296	
	BM 201		-19-	AF-8IP 296	
	BM 305		-19-	AF-9D 296	
				AF-9DP 296	
				AF-9I 296	
				AF-9IP 296	
BEDFORD	CF		-1980	LF-9 296 UN-1FS 296	
				LF-RO 296	
				LF-ROP 296	
				NE-10 296	
				NE-10P 296	
	CF		1980-	NE-10 296 UN-FT 296	
	CF 2 250 D		1980-	NE-10P 296 WAS-6 297	
	CF 2 350 D		1980-		WAS-6P
	TL 560		-19-	NE-1 296 LF-6 296	
	TL 860		-19-	NE-10 296	
	TL 1260		-19-	NE-10P 296	
	TM		-19-	NE-1P 296	
BROCKWAY	VARIOUS MODELS		-	BS-4D 297 BS-4D 297	
				YA-8D 297 YA-8D 297	
				YA-8I 297 YA-8I 297	
				HUD-1 297 HUD-1 297	
				YA-11D 297 YA-11D 297	
				YA-11I 297 YA-11I 297	
DAF	2800		-19-	CHR-3 297 FO-OA 297	
	3600		-19-	CHR-3P 297	
	FA 2100 DT		-19-		
	FA 2105		-19-		
	FA 2505		-19-		
	FA 2805		-19-		
	FA 3605		-19-		
	FAS 3605		-19-		
	FAT 2826		-19-		
	FAT 3626		-19-		
	FT 2505		-19-		
	FT 2805		-19-		
	FT 3605		-19-		
	FTT 2826		-19-		
	FTT 3626		-19-		
	2800 T. IN.		-1984	NE-3 297 FO-OA 297	
	FA 1100		1980-1982	NE-3P 297	
	FA 1300 T		1980-1982	NE-3P1 298	
	FA 2100		1980-1982	NE-3P2 298	
	FA 2500		1980-1982		
	F 1100		1985-1991	CHR-3 297 FO-OA 297	
	F 1300		1985-1991	NE-22P2 298	
	F 1700		1985-1991		
	F 1900		1985-1991		
	F 2100		1985-1991		
	F 2500		1985-1991		
	F 3626		1985-1991		

FOR: PARA:	MODEL MODELO	CCCCC	PAG.	PAG.	
DAF	FA 1100 DT		-19-	DAV-1 297 RO-4D 298	
	FA 1300 DNT		-19-	DAV-1P 297 RO-4I 298	
	FA 1300 DT		-19-	LAS-V 297	
	FA 2100		1982-1984		
	FA 2500		1982-1984		
	FA 2500		-19-	CHR-3 297 FO-OA 297	
				CHR-3P 297	
				NE-3 297	
				NE-3P 297	
				NE-3P1 298	
				NE-3P2 298	
	F-FA-V- 600		1985-1991	NE-11 298 FO-OA 297	
	F-FA-V- 800		1985-1991	NE-11P 298	
				WAS-6 298	
				WAS-6P	
	F-FA-V-1000		1985-1991		
	FT 75.270R		-19-	CHR-3 297 VO-VB 298	
	FT 85.360W		-19-	NE-22P 298 VO-VBP 298	
	FT 3300		-19-		
	SERIE FT		1991-	CHR-3 297 VO-VB 298	
				CHR-3P 297 VO-VBP 298	
	V 400		1991-	NE-11 298 NE-11 298	
	V 600		1991-	NE-11P 298 NE-11P 298	
	VARIOUS MODELS		-	NE-3D 297 NE-3D 297	
				WAS-4 298	
				WAS-4P	
DIAMOND REO	VARIOUS MODELS		-	HUD-1 298 HUD-1 298	
FIAT IVECO	30.8		-1991	FI-11 300 FI-11 300	
	35.10		-1991	FI-11P 300 FI-11P 300	
	35.8		-1991	FI-1P 299 FI-1P 299	
				FIS-1D 300 FIS-1D 300	
	40.10		-1991	FI-11 300 FI-11 300	
	49.10		-1991		
	30.8		1992-	FI-12 300 FI-11 300	
	35.10		1992-	FI-12P1 300 FI-11P 300	
	35.12		1992-		
	35.8		1992-		
	40.10		1992-		
	40 NC 35		-19-	AF-9D 299 AF-5D 299	
	40.8 F 8		-19-	AF-9DP 299 AF-5I 299	
				AF-9I 299 AF-6D 299	
				AF-9IP 299 AF-6I 299	
	50 NC		-19-	AF-9D 299 IMS-3 301	
	55 NC		-19-	AF-9DP 299 IMS-3P 301	
	80 NC		1979-	AF-9I 299 IMS-5 301	
	55		-19-	AF-9IP 299 IMS-5P 301	
				FEM-1D 299	
				FEM-1I 299	
	50.10 F 10		1979-	LF-RO 301 IMS-3 301	
	55.8 F 8		1979-	LF-ROP 301 IMS-3P 301	
	60.10 F 10		1979-	SIP-1 301 IMS-5 301	
	65.10 F 10		1979-		IMS-5P 301
	70.10 F 10		1979-		
	79.10 F 10		1979-		

Camión
Kamioi
Camions

Lkw
Camión
Ciężarowych



FOR: PARA:	MODEL MODELO	CCCCC	PAG.	PAG.
FIAT IVECO ®	79.13 F 13		1979-	
	79.14 F 14		1979-	
	80.13 F 13		1979-	
	95.14 F 14		1979-	
100			1979-	
	50.9	FI-6I	300	IMS-3 301
	60.11	FI-6IP1	300	IMS-3P 301
	65.12	FI-9I	300	IMS-5 301
	79.14	FI-9IP	300	IMS-5P 301
	80.14		1994	
	95.14		1994	
	109.14		1994	
	110.17		1994	
	110 NC	AF-8D	299	IMS-3 301
	110 P	AF-8DP	299	IMS-3P 301
	150.20	AF-8I	299	IMS-5 301
	160 NC	AF-8IP	299	IMS-5P 301
	170 NC 35	AF-9D	299	
100		AF-9DP	299	
110		AF-9I	299	
130		AF-9IP	299	
		FEM-1D	299	
		FEM-1I	299	
	115.17 D T.	FI-6I	300	FI-6I 300
	115.17 H	FI-6IP	300	FI-6IP 300
	145.17 H T.		1989	
	175.24		1989	
	135		1989	
	150 R.20	AF-9D	299	FI-5D 300
	150 T.20	AF-9DP	299	FI-5I 300
	159.20	AF-9I	299	IMS-3 301
	190 T.30	AF-9IP	299	IMS-3P 301
	190.26		1989	IMS-5 301
	190		1989	IMS-5P 301
	180.26	AF-7I	299	IMS-3 301
	180.26 T	AF-7IP	299	IMS-3P 301
	190.38	AF-9D	299	IMS-5 301
	190.38 T	AF-9DP	299	IMS-5P 301
	190.F 35	AF-9I	299	
	190.H 35	AF-9IP	299	
	180		1989	
	190 PC 26	BH-2	299	PRE-1I 301
	260		19-	
	190 TURBOS.	AU-1	299	FI-1I 300
		AU-HV	299	FI-1IP 300
		AU-HVP	299	
		BL-2	299	
		FIS-1D	300	
	190.26	FI-1I	300	NE-1 301
	190.30	FI-1IP	300	NE-1P 301
	190.32		1991	
	190.36		1991	
	190.42		1991	
	190.48		1991	
	240.26		1991	
	240.32		1991	
	240.36		1991	



FOR: PARA:	MODEL MODELO	CCCCC	PAG.	PAG.
FIAT IVECO ®	280.36		-1991	
	330.30		-1991	
	330.35		-1991	
	330.36		-1991	
	190.26	FI-1I	300	FI-1I 300
	190.30	FI-1IP	300	FI-1IP 300
	190.32		1992-	
	190.36		1992-	
	190.42		1992-	
	190.48		1992-	
	240.26		1992-	
	240.32		1992-	
	240.36		1992-	
	280.36		1992-	
	330.30		1992-	
	330.35		1992-	
	330.36		1992-	
	190.30	AF-7I	299	FI-5D 300
		AF-7IP	299	FI-5I 300
		AF-9D	299	IMS-3 301
		AF-9DP	299	IMS-3P 301
		AF-9I	299	IMS-5 301
		AF-9IP	299	IMS-5P 301
		BL-2	299	
	190.33 T.S.	VO-VB	301	FI-1I 300
	190.38 T.S.	VO-VBP	301	FI-1IP 300
	190.42 T.S.		1988	
	242 E-15	FI-3D	300	IMS-3 301
	242 E-18	FI-3DP3	300	IMS-3P 301
				IMS-5 301
				IMS-5P 301
	242.15	CT-1	299	IMS-3 301
	242.18	CT-1P	299	IMS-3P 301
		CT-3	299	IMS-5 301
		CT-3P	299	IMS-5P 301
	260.36	FI-1I	300	VO-VB 301
		VO-1	301	
	260.48	FI-1IP	300	VO-VBP 301
	330 F 35	VO-VB	301	IMS-3 301
	330.26	VO-VBP	301	IMS-3P 301
	330.30		1988	IMS-5 301
	330.32		1988	IMS-5P 301
	330.35		1988	
	330.36		1988	
	619.3A	AF-9D	299	AF-9D 299
	619.N	AF-9DP	299	AF-9DP 299
	642	AF-9I	299	AF-9I 299
		AF-9IP	299	AF-9IP 299
	643	AF-9D	299	AF-5D 299
	672	AF-9DP	299	AF-5I 299
		FEM-1D	299	AF-6D 299
		FEM-1I	299	AF-6I 299
	VARIOUS MODELS	FI-3	300	FI-3 300
		FI-3DP4	300	FI-3DP4 300
		FI-3DP5	300	FI-3DP5 300
	VARIOUS MODELS	FI-6IP2	300	FI-6IP2 300

FOR: PARA:	MODEL MODELO	CCCCC	PAG.	PAG.
FIAT IVECO ®		FI-6IP4	299	FI-6IP4 299
FORD (USA) ®	CARGO	1986-	NE-11P3 303	NE-11P3 303
	VARIOUS MODELS	-	MAZ-14D 303	MAZ-14D 303
			MAZ-1D 303	MAZ-1D 303
			MAZ-1I 303	MAZ-1I 303
			NE-1I 303	LF-WR 303
			NE-1IP 303	
			FO-11D 302	FO-11D 302
			FO-20D 303	FO-20D 303
			NE-1I 303	NE-1I 303
			NE-1IP 303	NE-1IP 303
			FO-15D 302	FO-15D 302
			FO-15DP 302	FO-15DP 302
FORD ®	A 0406	-19-	FO-E-TC 301	UN-FT 302
				UN-FS 302
	A 0406 R	-19-	FO-E-TCP 302	
	A 0509	-19-	FO-TX 302	
	A 0509 P	-19-	FO-TXP 302	
	A 0609	-19-	UN-FT 302	
	D 710 CUSTOM	-19-		
	CARGO	1986-1991	NE-11P3 302	
	TRANSCONTIN.	-19-	LF-6 302	LAS-R 302
				LAS-V 302
				UN-FS 302
	VARIOUS MODELS	-	ME-S 302	ME-S 302
			ME-SP 302	ME-SP 302
FREIGHTLINER ®	VARIOUS MODELS	-	BS-4D 303	BS-4D 303
			HUD-1 303	HUD-1 303
			YA-8D 303	YA-8D 303
			YA-27D 303	YA-27D 303
	VARIOUS MODELS	1994-2004	AMM-1 303	AMM-1 303
GM (CHEVROLET) ®	VARIOUS MODELS	-	MIT-1I 303	MIT-1I 303
			MIT-1IP 303	MIT-1IP 303
			MIT-2I 304	MIT-2I 304
			MIT-2IP 304	MIT-2IP 304
			TOYO-2 304	TOYO-2 304
GM (GMC) ®	MEDIUM TRUCK W4	1984-1986	DAT-6D 304	DAT-6D 304
	MEDIUM TRUCK W4	1984-1986	DAT-6DP1 304	DAT-6DP1 304
	MEDIUM TRUCK W4	1986-	ISU-2 304	ISU-2 304
	TILTMASTER TRUCK W4	1986-		
GMC ®	TILTMASTER NQR	2000-2011	GM-5 304	GM-5 304
			GM-5P 304	GM-5P 304
	TILTMASTER W5	1998-2011	GM-5 304	GM-5 304
	TILTMASTER W6	1998-2001	GM-5P 304	GM-5P 304
	TILTMASTER W7	1998-2007		
HINO ®	HEAVY DUTY	2005-2009	HIN-1	HIN-1



FOR: PARA:	MODEL MODELO	CCCCC	PAG.	PAG.
HINO ®	VARIOUS MODELS	-	TOYO-K1 304	TOYO-K1 304
			TOYO-K1P 304	TOYO-K1P 304
ISUZU ®	NKR	-19-	MIT-15P 305	MIT-15P 305
	NPR	-19-		
	NQR	-19-		
	TILTMASTER W4-W5 (S.N)	1986-1988	DAT-6D 305	DAT-6D 305
		1986-1988	DAT-6DPI 305	DAT-6DPI 305
			ISU-1 305	ISU-1 305
			ISU-2 305	ISU-2 305
			MIT-1I 305	
			MIT-1IP 305	
IVECO ®	VARIOUS MODELS	-	FI-6IP3 305	FI-6IP3 305
KENWORTH ®	MIDRANGER	1988-	NE-1I 305	NE-1I 305
			NE-1IP 305	NE-1IP 305
			FO-PN 305	
MACK ®	MIDLINER	1982-	BH-1 306	RO-4I 306
			BH-1P 306	
			DAV-1 306	
			DAV-1P 306	
	VARIOUS MODELS	-	BS-1I 306	BS-1I 306
			YA-11D 306	YA-11D 306
			AMM-1 305	AMM-1 305
			MAK-1 306	MAK-1 306
			BAS-4 306	BAS-4 306
MAGIRUS DEUTZ ®	90 M 5.3	-19-	BH-1 306	RO-4D 307
	90 M 6.0	-19-	BH-1P 306	RO-4I 307
			LAS-R 306	
			LAS-V 306	
	90 M 6.6	-19-		
	90 M 7	-19-		
	90 M 9	-19-		
	130 M 11	-19-		
	130 M 13	-19-		
	130 M 16	-19-		
	130 M 9	-19-		
	160 M 13	-19-		
	260	-19-	BH-2 306	PRE-1I 306
	360 D 18	-19-		
MAN ®	6.100 F	-19-	VO-R 307	VO-R 307
	6.90 F	-19-	VO-RP 307	VO-RP 307
			BL-2 307	
			FO-PN 307	
	8.136 F	-19-	HU-SC 307	
	8.90 F	-19-		
	9.136 F	-19-		
	9.136 FAE	-19-		
	9.150 F	-19-		
	10.136	-19-		
	10.150 F	-19-		



Camión
Kamioi
CamionsLkw
Camión
Ciężarowych



FOR: PARA:	MODEL MODELO			PAG.		PAG.
MAN ®	9.136	-19-				
	12.170	-19-	BH-1	307	HU-MN	307
	12.192 F-FT	-19-	BH-1P	307	HU-MNP	307
	12.192 FKT	-19-				
	12.232 FT	-19-				
	14.192 F	-19-				
	14.232 FKT	-19-				
	14.232 FT	-19-				
	17.232 F	-19-				
	18.272 FTI	-19-				
	19.240 F	-19-				
	19.262 F	-19-				
	19.321 F-F/2	-19-				
	19.322 F-FK	-19-				
	19.322 FLT	-19-				
	19.361 F-FT	-19-				
	19.361-T	-19-				
	19.363 F	-19-				
	19.372 FAK	-19-				
	19.422 F-FT	-19-				
	19.462 F	-19-				
	19.502 F-FLT	-19-				
	22.361	-19-				
	24.362	-19-				
	25.372 FNL	-19-				
	25.422 FNL	-19-				
	33.222 DF	-19-				
	33.240	-19-				
	33.281-T	-19-				
	33.292	-19-				
	33.362	-19-				
	33.365	-19-				
	33.372 DF	-19-				
	33.372 DFA	-19-				
	33.422 DF	-19-				
	33.422 DFA	-19-				
	40.440	-19-				
	41.372 VFK	-19-				
	41.422 VFK	-19-				
	33.320	-19-	BH-1	307	HU-SX	307
			BH-1P	307		



FOR: PARA:	MODEL MODELO			PAG.		PAG.
MERCEDES (ARGENTINA) ®	VARIOUS MODELS	-	ME-9P	307	ME-9P	307
			ME-13DP	308	ME-13DP	308
			ME-14P	308	ME-14P	308
	SPRINTER	1995-	ME-HMP	308	ME-HMP	308
	SPRINTER	2000-	ME-HMLP	308	ME-HMLP	308



FOR: PARA:	MODEL MODELO			PAG.		PAG.
MERCEDES ®	VARIOUS MODELS	-	ME-L	308	ME-L	308
			ME-S	308	ME-S	308



FOR: PARA:	MODEL MODELO			PAG.		PAG.
MITSUBISHI ®	FUSO	-1985	MIT-2I	308	MIT-2I	308
			MIT-2IP	308	MIT-2IP	308
	FUSO	1985-	MIT-10	308	MIT-10	308
			MIT-11D	308	MIT-11D	308
			MIT-9	308	MIT-9	308



FOR: PARA:	MODEL MODELO			PAG.		PAG.
---------------	-----------------	---	---	------	---	------



FOR: PARA:	MODEL MODELO			PAG.		PAG.
NISSAN ®	L.35	-1993	DAT-6	309	DAT-6	309
	M 115.17	-1993	DAT-6P	309	DAT-6P	309
	L.35.08	-1993	CHR-3	308	DAT-6	309
			NE-22P	309	DAT-6P	309
	L.70.09	-1993	CHR-5	308	DAT-6	309
	L.80.14	-1993			DAT-6P	309
	MODELOS	1980-	DAT-12	309	DAT-12	309
			DAT-6	309	DAT-6	309
			DAT-6P	309	DAT-6P	309
	VARIOUS MODELS	-	ROS-2	309	ROS-2	309



FOR: PARA:	MODEL MODELO			PAG.		PAG.
PEGASO ®	1236	-19-	CHR-5	309	IMS-5	309
					IMS-5P	310
			BL-2	309		
	360	-19-	AU-1	309	CHR-3	309
			AU-HV	309	CHR-3P	309
			AU-HVP	309	NE-22P1	310
			VO-HV	310		
			VO-HVP	310		
	620	-19-	CHR-3	309	VO-VB	310
			CHR-3P	309	VO-VBP	310
	VARIOUS MODELS	-	ROS-2	310	ROS-2	310
			BL-6	309	BL-6	309
			BL-6D	309	BL-6D	309



FOR: PARA:	MODEL MODELO			PAG.		PAG.
PIAGGIO ®	APE CAR	-19-	AF-9D	310	FAB-1	310
	APE CAR P3	-19-	AF-9DP	310		
	P 601	-19-	AF-9I	310		
			AF-9IP	310		
			FAB-1	310		
			FEM-1D	310		
			FEM-1I	310		
	APE P 50	-19-	FEM-1D	310		
	APE TM P 50	-19-	FEM-1I	310		
			NE-6	310		
			NE-6P	310		
	APE TM 703	-19-	AF-9D	310	FAB-1	310
	NICA 125	-19-	AF-9DP	310		
			AF-9I	310		
			AF-9IP	310		
			FAB-1	310		

FOR: PARA:	MODEL MODELO			PAG.		PAG.
RENAULT SAVIEM ®	B 70.35	-1987	CHR-3	311	VA-7	312
					VA-10	312
	B 70.45	-1987	CHR-3P	311		
	B 90.35	-1987	LMP-5	311		
			LMP-5P1	311		
			NE-22P	311		
	B 70.45	1988-1992	CHR-3	311	NE-28	311
	B 80.45	1992-	NE-22P	311		
	B 90.45	1988-1992				
	B 90.50	1988-1992				
	B 110.150	1992-				
	B 110.35	1992-				



FOR: PARA:	MODEL MODELO			PAG.		PAG.
---------------	-----------------	---	---	------	---	------

FOR: PARA:	MODEL MODELO			PAG.		PAG.
RENAULT SAVIEM ®	G 300 G	-1994	DAV-1	311	LAS-R	311
	G 330 GV	-1994	DAV-1P	311	LAS-V	311
			PJ-1	312		
			PJ-2	312		
			PJ-2P	312		
	G 340 TI	-1994	NE-3	311		
	GR 305	-1994	NE-3P	311		
	GR 305 TURBO	-1994	NE-3P1	311		
	R 310	1984-	NE-3P2	311		
	R 360	1984-1985				
	R 360 TURBO	1984-				
	GB 119	1986-	DAV-1	311	RO-4D	312
	GB 231 TURBO	1986-	DAV-1P	311	RO-4I	312
			LAS-R	311		
			LAS-V	311		
	GC 231 TURBO	1986-	DAV-1P	311	RO-4I	312
	GF 231 TURBO	1986-				
	GR 231 TURBO	1986-				
	JK 50-60	-19-	BH-1	310	RO-15	312
	JK 75-90	-19-	BH-1P	310	RO-4D	312
	JK 110-115	-19-			RO-4I	312
	JP 11	-19-	BH-1	310	RO-4D	312
			LAS-R	311		
			LAS-V	311		
	JP 13	-19-	BH-1P	310	RO-4I	312
	JP 13 TU	-19-				
	JP 115	-19-				
	M 160.12	-1994	NE-3	311	VA-10	312
	M 200.12	-1994	NE-3P	311		
	M 230.12	-1994	NE-3P2	311		
			RO-4D	312		
			RO-4I	312		
	M 230.13T	-1994	NE-3	311	VA-10	312
	M 230.16	-1994				
	MASTER P35 D	-1987	CHR-3	311	VA-7	312
	MASTER T30 D	-1987	CHR-3P	311		
			NE-28	311		
	MASTER T35 D	-1987	LMP-5	311		
			LMP-5P1	311		
			NE-22P	311		
	MASTER T30 D	1987-	CHR-3	311	NE-28	311
	MASTER T35 D	1987-	NE-22P	311		
	MASTER TURBO	1987-				
	R 350 TI	-1992	NE-3	311	VA-10	312
	R 365	-1992	NE-3P	311		
	R 380	-1992	NE-3P2	311		
	R 385	-1994				
	R 420	-1992				
	RI 357	-1992				
	R 360	1985-1987	NE-3	311	LAS-R	311
	R 370	1985-1987	NE-3P	311	LAS-V	311
	R 370 T U8 T	1985-1987	NE-3P2	311		
			RO-7D			
	S 100.06	-1994	NE-3	311	RO-4I	312
	S 100.07	-1994	NE-3P	311		
	S 100.08 T.	-1994	NE-3P2	311		
			NE-28	311		



FOR: PARA:	MODEL MODELO			PAG.		PAG.
---------------	-----------------	---	---	------	---	------



FOR: PARA:	MODEL MODELO			PAG.		PAG.
RENAULT SAVIEM ®			PJ-2	312		
			PJ-2P	312		
			LAS-R	311		
	S 150	-1994				
	S 160.08 T	-1994				
	S 160.09	-1994				
	S 170.13	-1994				
	S 170.145	-1994				
	SG2/35-40	-19-	BH-1	310	LAS-R	311
	SG3/35-40	-19-	BH-1P	310	LAS-V	311
			RO-17	312		
	SG4/35-40	-19-	BH-1P	310	LAS-V	311
	TRAFFIC	-1987	CHR-3	311	RO-17	312
			CHR-3P	311		
			NE-22P	311		
	TRAFFIC	1988-	NE-19	311	NE-28	311
			NE-19P	311		
	VARIOUS MODELS	-	NE-3D	311	NE-3D	311

FOR: PARA:	MODEL MODELO			PAG.		PAG.
ROVER ®	LEYLAND ROAD	-19-	NE-11	312	LAS-V	312
			NE-11P	312		
			UN-1FS	312		



FOR: PARA:	MODEL MODELO			PAG.		PAG.
SCANIA ®	112 H	-1987	VO-VB	313	WIT-1	313
	142 H 8V	-1987	VO-VBP	313		
	P 82	-1987				
	P 92	-1987				
	P 93 H-HL	1988-		</		



Camión
Kamioi
CamionsLkw
Camión
Ciężarowych

FOR: PARA:	MODEL MODELO			PAG.		PAG.
TATA ®	VARIOUS MODELS	-19-	ME-VA	314	ME-VA	314
TRUCK (USA) ®	VARIOUS MODELS	1995-	GM-14	314	GM-14	314
			GM-14P	314	GM-14P	314
			GM-25	314	GM-25	314
			GM-25P	314	GM-25P	314
VOLKSWAGEN ®	VARIOUS MODELS	-	VO-VB	314	VO-VB	314
			VO-VBP	314	VO-VBP	314
			VO-HV	314	VO-HV	314
			VO-HVP	314	VO-HVP	314
			VO-VB	314	VO-VB	314
			VO-VBP	314	VO-VBP	314
VOLVO ®	F 6	-19-	NE-12	315	NE-12	315
	F 7	-19-	NE-12P	315	NE-12P	315
			NE-9	315		
			NE-9P	315		
			WAS-1	315		
	F 10	-19-				
	F 12 T 6	-19-				
	F 1020 T 6	-19-	NE-3	315	NE-12	315
			NE-3P	315	NE-12P	315
			NE-3P2	315		
			NE-9	315		
			NE-9P	315		

FOR: PARA:	MODEL MODELO			PAG.		PAG.
VOLVO ®			WAS-1	315		
	FL 6 INTER.	-19-	NE-12	315	RO-4D	315
	FL 7 INTER.	-19-	NE-12P	315	RO-4I	315
			LAS-R	314		
			LAS-V	314		
	FL 10 INTER.	-19-	NE-12P	315	RO-4I	315
	FL 12 INTER.	-19-				
	FL 611	-19-	NE-12	315		
	FL 614	-19-	NE-12P	315		
	FL 616	-19-				
	VARIOUS MODELS	-	NE-1	315	NE-1	315
			NE-1P	315	NE-1P	315
			NE-3D	315	NE-3D	315
WHITE ®	VARIOUS MODELS	-1980	BS-4D	316	BS-4D	316
			HUD-1	316	HUD-1	316
	VARIOUS MODELS	-1989	BS-2	316	BS-2	316
			BS-5	316	BS-5	316
	VARIOUS MODELS	1980-1990	AMM-2	315	AMM-2	315
	VARIOUS MODELS	1980-2007	AMM-1	315	AMM-1	315

Motocicleta
Motozikleta
MotosMotorrad
Motociclos
Motocykli

FOR: PARA:	MODEL MODELO			PAG.		PAG.
APRILIA ®	AFI 50	1986-1991	ZA-1	317	ZA-1	317
	AFI 125	1986-1991	ZA-1P	317	ZA-1P	317
	AS 125 R.V.	1986-1991				
	ET 50	1986-1991				
	ETX 125 PV	1986-1991				
	ETX 350	1986-				
	ETX 600	1986-				
	MX 125 A	1986-1991				
	RED ROSE 50	1986-1990				
	RED ROSE 125	1986-1990				
	AMICO	1996-1998	ZA-6DPI	317	ZA-6DPI	317
	CLASSIC 125	1996-1999				
	GULLIVER	1995-1998				
	LEONARDO	1996-2004				
	MOTO 6.5	1996-2002				
	PEGASO	1997-2004				
	PEGASO 3-650	1996-				
	RALLY	1996-2004				
	RX 50	1996-2004				
	SR 50	1996-2004				
	AMICO 50	1992-	ZA-4DP	317	ZA-4DP	317
	EUROPA 50	1992-				
	FUTURA 50AE	1992-				
	PEGASO 50	1992-				
	PEGASO 600	1990-				
	PEGASO 650	1990-				
	RED ROSE 50	1992-				
	RS 50 EXTRE.	1992-				
	RX 50	1992-1996				
	SR 50	1992-1996				
	AREA 51	1998-2000	ZA-6DPI	317	ZA-6DPI	317
	CLASSIC 50	1996-1999				
	ETV 1000 C.	2001-2007				
	MOJITO	1999-2008				
	MX	2002-2006				
	RS	1996-2005				
	RST FUTURA	2000-2003				
	RSV 1000	1998-2005				
	SCARABEO	1993-				
	SL 1000 F.	2000-2003				
	SONIC 50	1998-2008				
	SPORTCITY	2004-				
	SR 125-150	1999-2001				
	ATLANTIC 125	2003-	ZA-9P1	317	ZA-9P1	317
	CLIMBER 280	1994-	ZA-4DP	317	ZA-4DP	317
	EUROPA 125	1994-				
	FUTURA 50	1990-1991				
	PEGASO 125	1994-				
	RED ROSE 125	1994-				
	RX 125 EXT.	1994-				
	RX 125 REP.	1994-				
	SIX DAYS RX	1990-1991				
	TUAREG R. 50	1994-				
	EUROPA 125AE	1992-	ZA-1	317	ZA-1	317
	EXTREMA 125	1993-	ZA-1P	317	ZA-1P	317
	PEGASO 125	1993-1994				
	RED ROSE 125	1993-1994				
	RX 125	1992-				
	TUAREG 125	1986-1991				

FOR: PARA:	MODEL MODELO			PAG.		PAG.
APRILIA ®	FILO GT 4L	-19-	AF-8D	317		
	MX 250	-19-	AF-8DP	317		
	RC 250	-19-	AF-8I	317		
			AF-8IP	317		
			FEM-2D	317		
			FEM-2I	317		
	FUTURA 50AE	1990-1991	ZA-13P	317		
	RX 50	1990-1991				
	FUTURA 125	1990-1991	ZA-2P	317		
	REPLICA 50	1990-1991				
	RALLY 125	1990-1991	ZA-1	317	NE-8	317
	RX 125	1990-1991	ZA-1P	317		
	RED ROSE 50	1990-1991	FI-1I	317	ZA-1	317
			FI-1IP	317	ZA-1P	317
			ZA-2P	317		
	TUAREG 125	1992-	ZA-2P	317	ZA-2P	317
	TUAREG 250	1986-	ZA-1	317	NE-8	317
	TUAREG 350	1986-	ZA-13P	317		
	TUAREG 600	1986-	ZA-1P	317		
	VARIOUS MODELS	2001-	ZA-9P2		ZA-9P2	
ATALA ®	BYTE AT10-50	1996-	ZA-4DP	317	ZA-4DP	317
	GREEN	1996-				
	HAKER	1996-				
BENELLI ®	124	-19-	FEM-ID	317		
	125 TURISMO	-19-	FEM-II	317		
	125 SPORT	1982-1983			NE-8	318
	125 SPORT	1983-1984	FEM-2D	317	NE-6	317
	T 125	-19-	FEM-2I	317	NE-6P	318
	125 SPORT	1984-	FEM-2D	317	NE-8	318
	125 TURISMO	1984-	FEM-2I	317		
	250 2C	-19-			ZA-1	318
	304 4C	-19-			ZA-1P	318
	354	-19-				
	654	-19-				
	750 SEI	-19-				
	900 SEI	-19-				
	EXPORT 3V	-19-			ZA-1	318
	G2	-19-			ZA-1P	318
	MAGNUM 3V	-19-				
	MOTORELLA 50	-19-				
	LASER	-19-			ZA-1	318
	S 50	1985-			ZA-1P	318
	S 125	-19-				
BETA ®	50 CC	-1993	AF-5I	318	ZA-1	318
					ZA-1P	318
	ALP	-19-	ZA-9P1	318		
	RR	2005-				
	CHRONO	1995-	ZA-4DP	318		
	CHRONO 502	1995-				
	QUADRA	1995-				
	TEMPO	1995-				
	KR 50	-19-	FAB-1	318	FAB-1	318
	KR 125	-19-				
	KR 250	-19-				

Motocicleta
Motozikleta
Motos

Motorrad
Motociclos
Motocykli

FOR: PARA:	MODEL MODELO			PAG.		PAG.
---------------	-----------------	--	--	------	--	------

BETA ®	VRS 50	-19-				
	QUADRA	1996-	ZA-6DPI	318	ZA-6DPI	318
	TEMPO	1996-				

BICICLETTES CYCLES ®	MOD.DANES DK	-19-			AS-17D	318
	MOD.SUECO S	-19-			AS-21	318
					AS-21D	318
					AS-2D	318
				AS-2I	318	
RALEIGH	-19-			LF-2	319	
				UN-FP	319	
				AS-21DP	318	AS-21DP
VARIOUS MODELS	-		AS-21DP	318	AS-21P	AS-21P

BIMOTA ®	GPI 1	1990-	ZA-1	319	ZA-1	319
			ZA-1P	319	ZA-1P	319
	HB 2	-19-	NE-6	319	NE-6	319
			FAR-1D	319	FAR-1D	319
	HB 3	-19-	NE-6P	319	NE-6P	319
			FAR-1I	319	FAR-1I	319
	HB 3/S	-19-	NE-6P	319	NE-6P	319
			FAR-1I	319	FAR-1I	319
	KB 1	-19-	SUZU-13P	319	NE-6	319
		KB 2/TT	-19-	SUZU-4I	319	NE-6P
				SUZU-4IP	319	
	SB 2	-19-	SUZU-13P	319		
			SUZU-4I	319		
			SUZU-4IP	319		
SB 3	-19-	SUZU-5	319	NE-6	319	
	SB 4S	-19-	SUZU-5P	319	NE-6P	319
SB 4SP		-19-				

BMA ®	AMICA 50	-19-	AF-9D	319	UN-MRN	320
	AMICA 125	-19-	AF-9DP	320		
	AMICA 250	-19-	AF-9I	320		
	AMICA 360	-19-	AF-9IP	320		
			FEM-1D	320		
		FEM-1I	320			

BMW ®	400 RS	1984-1985	NE-6	320	NE-6	320
			NE-6P	320	NE-6P	320
	450	1984-1986	NE-7	320	NE-7	320
		1984-1986				
	K 1	1987-1993				
	K 75	1984-1992				
	K 75 RT	1993-				
	K 75 S	1993-				
	K 100	1984-1992				
	K 100 RS	1993-				
	K 1100 LT	1993-1994				
	K 1100 RS	1993-1994				
	R 45	1984-1986				
	R 65	1984-1992				
	R 80	1984-				
	R 80 GS	1993-				
	R 80 R	1993-				

FOR: PARA:	MODEL MODELO			PAG.		PAG.
---------------	-----------------	--	--	------	--	------

BMW ®	R 80 RT	1993-				
	R 100 GS	1993-				
	R 100 R	1993-				
	R 100 RS	1993-				
	R 100 RT	1993-				
	F 650	1994-	ZA-6DP	320		
	K 1100	1994-1995	BM-HBP1	320	BM-HBP1	320
	K 1100 LS	1994-				
	K 1100 LT	1994-				
	R 1100	1994-1995				
	R 1100 GS	1994-				
	R 1100 R	1994-				
	R 1100 RT	1994-				
	K 1100	1995-	BM-HBP1	320	BM-HBP1	320
	R 850 RT	1996-2002				
R 1000	1995-					
R 1100	1995-					
R 60/6	-19-	NE-7	320	NE-6	320	
R 75/6	-19-			NE-6P	320	
R 80/7	-19-					
R 90 S	-19-					
R 90/6	-19-					
R 60/7	-19-	NE-7	320	NE-6	320	
		BL-2	320	BL-2	320	
R 75/7	-19-			NE-6P	320	
R 100 RS	-19-					
R 100/7	-19-					
R 100/S	-19-					

BUELL ®	BLAST	2000-2009	ZA-9P1	320		
	FIREBOLT	2002-2009				
	LIGHTNING	2003-2009				
	ULYSSES	2006-2009				

CAGIVA ®	125 ALETA	1986-			ZA-1	321
	COCIS 50	-1991			ZA-1P	321
	200 ELEFANT	1984-			ZA-1	321
	350 ALA	1984-1987			ZA-1P	321
	CRESTA 350	1984-1987				
	DG 350	1984-1987				
	SST 350 RL	1984-1987				
	SX 350	1984-1987				
	650	-19-	SUZU-13P	321	SUZU-13P	321
			SUZU-4I	321	SUZU-4I	321
			SUZU-4IP	321	SUZU-4IP	321
			SUZU-4IP	321	SUZU-4IP	321
	900 ELEFANT	1997-	KAW-6P	321		
	ALETA EL.125	-19-			ZA-1	321
	RX 250	1984-			ZA-1P	321
SST 250 ALA	1984-					
SST 250 RL	1984-					
SX 250	1984-					
SXT 250	1984-					
WMX 250	1984-					
WMX 500	1984-					
ALETA ORO L.	1986-	FI-6I	321	ZA-1	321	
		FI-6IP2	321	ZA-1P	321	
		FI-6IP3	321			

FOR: PARA:	MODEL MODELO			PAG.		PAG.
---------------	-----------------	--	--	------	--	------

CAGIVA ®	ALETA ROSA	1986-	SUZU-13P	321	ZA-1	321
	K 3	1991-1992	SUZU-4I	321	ZA-1P	321
				SUZU-4IP	321	
	AR 350	1984-1989	SUZU-13P	321	ZA-1	321
				SUZU-4I	321	ZA-1P
	ELEFA. 2 125	-19-	SUZU-4I	321	ZA-1P	321
	ELEFA. 2 200	-1984	SUZU-4IP	321		
	ELEFA. 2 350	1984-1989				
	ELEFA. 2 600	-19-				
	BLUES 125	-19-	FI-1	321	FI-1	321
	TAMANACO 125	-19-	FI-1P	321	FI-1P	321
	CITY	1993-1994	KAW-6P	321	KAW-6P	321
	ELEFA. 900	1992-				
	MITO	1992-				
	MITO 125	1991-1992				
MITO CARENA.	1991-1992					
MITO EV	1994-1995					
MITO LAWSON	1993-					
MITO RACING	1991-1994					
PRIMA	1993-					
SUPER CITY	1993-					
CITY	1994-	ZA-8P	321	ZA-8P	321	
CITY LUCKY	1994-					
CITY PASSING	1994-					
SUPERCITY	1994-					
ELEFA. 90	-1991	FI-1	321	ZA-1	321	
ELEFA. 750	-1991	FI-1P	321	ZA-1P	321	
LUCKY 350 E.	1987-1991					
PARIS DAKAR	-1991					
T 350 E	1987-1991					
T4 350 R	1987-1991					
FRECCIA 125	-19-	FI-1	321	FI-1	321	
		FI-1P	321	FI-1P	321	
		MER-16D	321	MER-16D	321	
FRECCIA 125	1991-1992	FI-1	321	ZA-1	321	
N 90	1991-1992	FI-1P	321	ZA-1P	321	
FULL FUN 125	-1990	FI-1	321	FI-1	321	
MITO 125	-1990	FI-1P	321	FI-1P	321	
MMX 125	-1990					
HD 175	-19-	FEM-1D	320			
HD 350	-19-	FEM-1I	320			
LUCKY 350 EX	-1991	FI-1	321	ZA-1	321	
T4 350	-1991	FI-1P	321	ZA-1P	321	
T4 500 E	-1991					
MITO RACING	1994-	KAW-6P	321	KAW-6P	321	
RIVER 600 C.	1995-	ZA-4DP	321			
ROADSTER 125	1994-	ZA-1	321			
		ZA-1P	321			
S.CITY 125	1992-	ZA-4DP	321	ZA-4DP	321	
SST 125	1984-	SUZU-13P	321	ZA-1	321	
SXT 125 N	1984-	SUZU-4I	321	ZA-1P	321	
W 8	1994-	SUZU-4IP	321			
SST-SX 125	-1984	FEM-1D	320	ZA-1	321	
SST-SX 250	-1984	FEM-1I	320	ZA-1P	321	
SXT 125	1984-	SUZU-13P	321			
		SUZU-4I	321			

FOR: PARA:	MODEL MODELO			PAG.		PAG.
---------------	-----------------	--	--	------	--	------

CAGIVA ®			SUZU-4IP	321		
	TRIAL 125	-19-			CL-2I	320
	TRIAL 350	-19-			CL-3I	320
	VARIOUS MODELS	-19-	FI-6IP4	320	FI-6IP4	320
W 12 350	1994-	ZA-1	321	ZA-1	321	
			ZA-1P	321	ZA-1P	321
W 16	1997-	ZA-1	321	ZA-1	321	
			ZA-1P	321	ZA-1P	321

CIMATTI ®	GRINGO GI-4M	-19-			ZA-1	322
	GRINGO LUX	-19-			ZA-1P	322
			FAB-1	322	FAB-1	322

DEMME ®	SMILY	-19-			NE-6	322
					NE-6P	322

DERBY ®	ATLANTIS 100	2003-	ZA-9P1	322	ZA-9P1	322
	MULHACEN	2006-	ZA-9P1	322	ZA-9P1	322
	PREDATOR	1999-			ZA-9P1	322

DKM-HERCULES ®	125 G SPEC.	-19-			NE-6	322
	175 GS	-19-			NE-6P	322
	250 GS	-19-				
	505 P	-19-				
	531	-19-				
535 S	-19-					

DUCATI ®	125 REG. 2T	-19-			NE-6	323
					NE-6P	323
	250 SCRAMBL.	1982-	FEM-1D	322	NE-6	323
	350 GTV	1982-	FEM-1I	322	NE-6P	323
	350 SCRAMBL.	1982-	FEM-2D	322		
	450 SCRAMBL.	1982-	FEM-2I	322		
	500 2 CIL.	1982-				
	500 GTL	1982-				
	500 SL PANT.	1982-				
	750 GT-SS	1982-	</			

Motocicleta
Motozikleta
Motos

Motorrad
Motociclos
Motocykli

FOR: PARA:	MODEL MODELO			PAG.		PAG.
DUCATI						
	750 SS					1991-1992
	851 S					1991-1992
	851 SPORT					1991-1992
	888 RACING					1993-
	888 S.P.4					1991-1992
	888 S.P.5					1993-
	900 M					1993-
	900 S.L.					1991-
	900 S.S.					1991-1992
	900 SS					1991-
	907 i.e.					1991-1992
	600 MONSTER		KAW-6P	323		
	748					1995-2003
	750 S.SPORT					1999-2003
	900 MONSTER					1994-2001
	900 S.SPORT					1998-2002
	996					1999-2004
	ST 2					1997-2003
	ST4					1998-2003
	750 FI DESMO	1986-1991	FEM-1D	322	NE-8	323
			FEM-1I	322		
			FEM-2D	322		
			FEM-2I	322		
			FI-6I	322		
			FI-6IP3	323		
			ZA-1	323		
			ZA-1P	323		
			FAR-1D	322		
			FAR-1I	322		
	750 FI DESMO	1987-	ZA-13P	323	ZA-13P	323
	851 SPORT	1989-1990				
	907 i.e.	1989-1990				
	DESMO 900 SS	1989-				
	PASO 906	1989-				
	750 INDIANA	1990-1991	FI-6I	322	FI-6I	322
	750 SPORT R	1990-1991	FI-6IP3	323	FI-6IP3	323
	PASO 750 LTD	1990-1991				
	851 S	1990-1991	FI-6I	322	ZA-1	323
	900 S.S.	1990-1991	FI-6IP3	323	ZA-1P	323
	907 i.e.	1992-	ZA-4DP	323	ZA-4DP	323
	CARENATA	1991-	KAW-6P	323	KAW-6P	323
	CUPOLINO	1991-				
	INDIANA 350	1987-			ZA-1	323
	INDIANA 650	1987-			ZA-1P	323
	INDIANA 750	1987-				
	PASO 350	1987-	ZA-13P	323	ZA-1	323
	PASO 750	1987-			ZA-13P	323
					ZA-1P	323
	VARIOUS MODELS	-19-	FI-6IP4	322	FI-6IP4	322
	VARIOUS MODELS	1985-1992	FI-6IP2	322	FI-6IP2	322

FANTIC MOTOR	50.1 OASIS	1984-1991			ZA-1	324
	CABALLERO	1992-			ZA-1P	324
	CABALLERO 50	1984-1991				
	CLAN 50	1982-				
	CLUBMAN	1993-				

FOR: PARA:	MODEL MODELO			PAG.		PAG.
FANTIC MOTOR						
	ISSIMO					1982-
	JOY 3V					1984-1991
	JOY MK					1984-1991
	JOY VK					1984-1991
	KOALA					1993-
	K-ROO					1992-
	RAIDER 50.1					1984-1991
	RAILLY 240					-19-
	TENTER TO					1984-1991
	TRIAL 50					1982-
	TRIAL 201					-1991
	TRIAL 240					-1991
	TRIAL 241					-1991
	TRIAL 242					-1991
	TRIAL 245					-1991
	TRIAL 300					-1991
	TRIAL 301					-1991
	TRIAL 303					-1991
	TRIAL 305					-1991
	TRIAL KID					1984-1991
	TRIAL S.5					1984-1991
	TRIAL S.7					1984-1991
	125	1984-	ZA-1	324	ZA-1	324
	125 SPORT	1984-	ZA-1P	324	ZA-1P	324
	ISSIMO 50	1984-				
	RAIDER 50	1984-				
	RAIDER GT 50	1984-				
	SPRINTER 3V	1984-				
	SPRINTER 50	1984-				
	SPRINTER MU.	1984-				
	STRADA 50	1984-				
	ENDURO 50	1985-			NE-8	324
	RAIDER 125	-19-				
	TRIAL 50	1985-				
	TRIALMATIC50	1985-				
	GR.TUR.50 CC	-19-			NE-6	324
					NE-6P	324
	HP1 125	-19-	FI-6I	323	FI-6I	323
			FI-6IP3	323	FI-6IP3	323
			ZA-1	324	ZA-1	324
			ZA-1P	324	ZA-1P	324
	LEI 50 CC	-19-			IMS-5	323
					IMS-5P	323
	RAIDER 125LC	-19-			ZA-1	324
					ZA-1P	324
	STRADA 125	1983-	ZA-1	324	ZA-1	324
			ZA-1P	324	ZA-1P	324
	STRADA 125	1985-1988	FI-6IP2	323	FI-6IP2	323
	VARIOUS MODELS	-19-				
	TRIAL 125	-19-			NE-8	324
	TRIAL 200	-19-			ZA-1	324
					ZA-1P	324
	VARIOUS MODELS	-19-	FI-6IP4	323	FI-6IP4	323



GARELLI	BASIC 50	1985-			ZA-1	324
	BASIC2 50	1985-			ZA-1P	325

FOR: PARA:	MODEL MODELO			PAG.		PAG.
GARELLI						
	FORMUNO					1988-1991
	GARY					1992-
	GARY DUE 50					1988-1991
	GARY UNO 50					1988-1991
	SAHEL 50 ES					-1991
	TEAM 3V 50					-1991
	TEAM BIMATIC					-1991
	TEAM MATIC					-1991
	URKA AC-LC50					-1991
	VIP N3V 50					-1991
	CICLONE 50	-1986		AF-19		324
	CICLONE 5V 5	-1986		AF-19P		324
	EUREKA FLEX	-19-		IMS-5		324
	JUNIOR T 50	1982-1986		IMS-5P		324
	JUNIOR GT 50	1982-1986		ZA-1		324
	JUNIOR K1005	-1986		ZA-1P		325
	NOI 50	-1986				
	VIP 1-N50	-19-				
	VIP 2-N50	-19-				
	VIP 3-N50	-19-				
	VIP 4-N50	-19-				
	CICLONE 5VN	1986-1988	ZA-1	324	ZA-1	324
	CICLONE LC	1986-1988	ZA-1P	325	ZA-1P	325
	NOI BIMATIC	1987-1991				
	NOI MATIC	1987-1991				
	NOI TL 50	1987-1991				
	GRAN TURISMO	-19-			NE-6	324
					NE-6P	324
	GTA 125	-19-	FI-6I	324	FI-6I	324
			FI-6IP3	324	FI-6IP3	324
			ZA-1	324	ZA-1	324
			ZA-1P	325	ZA-1P	325
	SUPER VIP	1985-1989	AF-6D	324	ZA-1	324
	TIGER 125XLE	-19-			ZA-1P	325
	TRS 125 S.M.	-19-				
	XR 125 TIGER	-19-				
	TIGER XRD	-19-	ZA-1	324		
			ZA-1P	325		
	VARIOUS MODELS	-	JD-2		JD-2	
			FI-6IP4	324	FI-6IP4	324

GILERA	50 GSA LUS	-19-	AF-6D	325	NE-8	325
	50 TS-GSA	-19-				
	50 R1	-19-			ZA-2P	326
	50 RALLY	-19-				
	50 RC TRO.	-19-				
	50 TREND	-19-				
	50 SIOUX A	-19-	ZA-4DP	326	ZA-4DP	326
	125 APACHE	1991-				
	125 CROMO	1991-				
	125 FREE ST	-19-				
	125 GFR S.P	-19-				
	125 SIOUX	-19-				
	350 NORDWES	1993-				
	600 NORD WE	-19-				
	600 R	1993-				
	600 RC	1991-				

FOR: PARA:	MODEL MODELO			PAG.		PAG.	
GILERA							
	RC 750 R					-19-	
	TYPHOON					-1995	
	125 CX AE	-19-	ZA-1	326	ZA-1	326	
	503 AE	1993-	ZA-1P	326	ZA-1P	326	
	BULLIT AE	1992-					
	BULLIT KICK	1992-					
	BULLIT MIX	1993-					
	SIOUX AE	1993-					
	125 GR1-TG1	-19-			NE-6	325	
	150	-19-			NE-6P	325	
	ECO 50	-19-					
	125 GRF	1993-	ZA-1	326	ZA-1	326	
	125 R	1993-	ZA-1P	326	ZA-1P	326	
	125 MRX	-1991	FI-1	325	FI-1	325	
	125 RC	-1991	FI-1P	325	FI-1P	325	
	125 SPO1	-1991					
	125 SPO2	-1991					
	125 XR2 R.	-1991					
	125 TG2	-19-	AF-6D	325	ZA-1	326	
					ZA-1P	326	
					FAR-1D	325	
					FAR-1I	325	
	200 T 4	-19-	AF-9D	325			
	200 T45	-19-	AF-9DP	325			
	CUSTOM 125	-19-	AF-9I	325			
	CUSTOM 200	-19-	AF-9IP	325			
			FEM-1D	325			
			FEM-1I	325			
	250 NGR	-19-	FI-6I	325	FI-6I	325	
			FI-6IP3	325	FI-6IP3	325	
					ZA-1	326	
					ZA-1P	326	
	350 DAKOTA	-1990	FI-6I	325	FI-6I	325	
			ZA-1	326	ZA-1	326	
	500 DAKOTA	-1990	FI-6IP3	325	FI-6IP3	325	
			ZA-1P	326	ZA-1P	326	
	500 SATURNO	-1990	ZA-2P	326	ZA-2P	326	
	600 RC	-1990					
	ARIZONA 125	-19-	ZA-1	326	ZA-1	326	
	ARIZONA 250	-19-	ZA-1P	326	ZA-1P	326	
	RTX 125-200	-19-					
	RV 125-200	-19-					
	RX 125-200	-19-					
	CBA 50	-1991			ZA-1	326	
					ZA-1P	326	
	NCR 50	2006-	ZA-9P1	326	ZA-9P1	326	
	NEXUS	2006-					
	RUNNER	2006-					
	RC 600 R	1991-	ZA-1	326	ZA-1	326	
			ZA-1P	326	ZA-1P	326	
	STORM 50	1995-	ZA-7DP	326			
	TYPHOON	1995-	ZA-7DP	326			
	VARIOUS MODELS	-	ZA-7DP1		ZA-7DP1		
			FI-6IP4	325	FI-6IP4	325	
	HARLEY DAVIDSON	883 SPORT.	1994-	HD-4D	326	HD-4D	326



Motocicleta
Motozikleta
MotosMotorrad
Motociclos
Motocykli



FOR: PARA:	MODEL MODELO			PAG.		PAG.
HARLEY DAVIDSON	1200 SPORT.	1994-				
	FLH 1340 EL	-19-	HD-1	326	NE-6	326
	FLHC 1340 EL	-19-	HD-1D	326	NE-6P	326
	FLHC 1340 S.	-19-	HD-2	326	NE-8	326
	FLT 1340 TO.	-19-	HD-2D	326		
	FLTC 1340 TO	-19-	HD-3	326		
	FXB 1340 ST.	-19-	HD-3D	326		
	FXE 1340 SU.	-19-				
	FXPS 1340 SU	-19-				
	FXR 1340 SU.	-19-				
	FXS 1340 LOW	-19-				
	FXWG 1340 WI	-19-				
	XLH 1000 SP	-19-				
	XLS 1000 RO	-19-				
	SPORTSTER SERIES C	2012	HD-5		HD-5	
	STREET 500	2015	HD-7D		HD-7D	
	VARIOUS MODELS	-	BS-6	326		
			CHI-IT	326	CHI-IT	326



HERCULES	K 125	-19-	YAMA-2II	326		
			YAMA-2IIP	326		

HM	LOCUSTA	-19-	ZA-9P1	327		
-----------	---------	------	--------	-----	--	--

HONDA	-	-	HOND-9D	327	HOND-9D	327
	125 E	1980-1982	SUZU-13P	329	NE-6	329
			FAB-1	327	FAB-1	327
	125 SILHO.	1980-	SUZU-4I	329	NE-6P	329
			SUZU-4IP	329		
	125 E	1982-	SUZU-13P	329	NE-8	329
			SUZU-4I	329		
			SUZU-4IP	329		
			FAR-1D	327		
	125 LEAD	1991-	HOND-4I	327	HOND-4I	327
			HOND-4IPI	327	HOND-4IPI	327
	125 S	1980-	SUZU-13P	329	NE-6	329
	125	1980-	SUZU-4I	329	NE-6P	329
			SUZU-4IP	329		
	125 VISION	-19-	SUZU-13DP	329	SUZU-13DP	329
			SUZU-4D	329	SUZU-4D	329
			SUZU-4DP	329	SUZU-4DP	329
	200 R	-1989	HOND-19	328	HOND-19	328
			HOND-19D	328	HOND-19D	328
			HOND-19DP	328	HOND-19DP	328
			HOND-19P	328	HOND-19P	328
			HOND-4D	327	HOND-4D	327
			HOND-4DP	327	HOND-4DP	327
			HOND-4DP2	327	HOND-4DP2	327
			HOND-4I	327	HOND-4I	327
			HOND-4IP	327	HOND-4IP	327
	350 FOUR	1979-1981	HOND-7I	327	NE-6	329
	500 FOUR	1979-			NE-6P	329
	350 FOUR	1981-	HOND-4D	327	NE-6	329
			HOND-4DP	327	NE-6P	329
			HOND-4DP2	327		



FOR: PARA:	MODEL MODELO			PAG.		PAG.
HONDA	400 CBF	1979-	HOND-22D		HOND-22D	
			HOND-3I	327	NE-6	329
					NE-6P	329
	400 FOUR	1981-1982	HOND-4D	327	NE-6	329
	CB 750 K	1980-	HOND-4DP	327	NE-6P	329
	CM 400 T	1981-1982	HOND-4DP2	327		
	500 CBT	-	HOND-22D		HOND-22D	
	CB 550 F	1979-				
	CB 750 F	1979-				
	500 CBT	-19-	HOND-3I	327	NE-6	329
					NE-6P	329
	500 FOUR	1976-1979	HOND-49	329	NE-6	329
					NE-6P	329
			HOND-49	329	HOND-49	329
	500 FOUR K	1979-	HOND-4D	327		
			HOND-4DP	327		
			HOND-4DP2	327		
	500 R	1983-	VO-VBP1	329	VO-VBP1	329
	500 R CROSS	1982-	HOND-4D	327	NE-8	329
	CB 750 C	1979-	HOND-4DP	327		
	CB 900 B.	1982-	HOND-4DP2	327		
	CB 900 F	1982-				
	CB 900 FII	1982-				
	CB 1100 R	-19-				
	CBR 250 F	1986-				
	CBX 400 F	1982-				
	CBX 400 FC	1984-				
	CBX 400 FII	1984-				
	FT 500	1983-1984				
	RAVEL 250	1986-				
	REBEL 250	1986-				
	XL 500 R	1982-1984				
	XL 500 S	1982-				
	XR 500 R	1982-1984				
	600 PROA.	1985-1991	HOND-4D	327	HOND-4D	327
	600 VTR.	1985-1991	HOND-4DP	327	HOND-4DP	327
	XL 600	1985-1991	HOND-4DP2	327	HOND-4DP2	327
	XL 600 LM	1985-1991	HOND-4I	327	HOND-4I	327
	XL 600 R	1985-1991	HOND-4IP	327	HOND-4IP	327
	XL 600 RM	1985-1991				
	XL 600 RX	1985-1991				
	600 R	1983-	VO-VBP1	329	VO-VBP1	329
	600 V.T.	1992-	HOND-4D	327	HOND-4D	327
	NTV 650	1992-1996	HOND-4DP1	327	HOND-4DP1	327
	NX 650 D	1983-	HOND-4DP2	327	HOND-4DP2	327
	VFR 750	1986-1989				
	VT 600	1989-				
	600 VT.R.	1990-	HOND-4I	327	HOND-4I	327
	CBR 600 F	1987-	HOND-4IPI	327	HOND-4IPI	327
	CBR 1000	1991-1992				
	VF 750 C	1990-				
	VFR 750 FK	1990-1991				
	VFR 750 FL	1990-1991				
	VFR 750 P.	1990-1991				
	VFR 750 R	1990-1991				
	XRV 750 A.	1992-				
	650 G.W.	1983-1991	HOND-4D	327	HOND-4D	327

FOR: PARA:	MODEL MODELO			PAG.		PAG.
HONDA	ASPENCADE	-1991	HOND-4DP	327	HOND-4DP	327
	CB 250 N	1982-1985	HOND-4DP2	327	HOND-4DP2	327
	CB 250 RS	1982-1985				
	CB 550	1982-				
	CBR 1000	-1991				
	CBX 1100 6C.	-19-				
	CL 250 N	1982-1985				
	CL 250 S	1982-1985				
	CM 250 C	1982-1985				
	ENTERSTAT	-1991				
	G.WING 1.2	-1991				
	GL 500	1982-				
	ST 1100 PE	1991-				
	VT 500	1983-1984				
	X 400 R	1986-				
	750 AFRICA	1991-	HOND-19	328	HOND-19	328
			HOND-19D	328	HOND-19D	328
			HOND-19DP	328	HOND-19DP	328
			HOND-19P	328	HOND-19P	328
			HOND-4D	327	HOND-4D	327
			HOND-4DP1	327	HOND-4DP1	327
			HOND-4DP2	327	HOND-4DP2	327
	750 FOUR	1979-	HOND-4D	327		
			HOND-4DP	327		
			HOND-4DP2	327		
			HOND-4I	327		
			HOND-4IP	327		
	750 RXLV	1985-	HOND-4I	327	HOND-4I	327
	750 XLV	1985-	HOND-4IP	327	HOND-4IP	327
	1100 GOLD W.	-19-	HOND-4D	327		
	CB 750 F.	1980-	HOND-4DP	327		
	CB 750 FII	1981-	HOND-4DP2	327		
	1200 G.W.	-1991	HOND-4D	327	HOND-4D	327
			VO-VBP1	329	VO-VBP1	329
	GL 1200	-1991	VO-VBP1	329	VO-VBP1	329
			HOND-4DP	327	HOND-4DP	327
			HOND-4DP2	327	HOND-4DP2	327
	GL 1500	-1991	VO-VBP1	329	VO-VBP1	329
			HOND-4DP	327	HOND-4DP	327
			HOND-4DP2	327	HOND-4DP2	327
	GX 1200 DL	-1991	VO-VBP1	329	VO-VBP1	329
			HOND-4I	327	HOND-4I	327
			HOND-4IP	327	HOND-4IP	327
	BIG RED 125	1986-	HOND-19	328	HOND-19	328
	NH 125 PEAD	1986-	HOND-19D	328	HOND-19D	328
	SPACY	-19-	HOND-19DP	328	HOND-19DP	328
	XL 125	1984-1986	HOND-19P	328	HOND-19P	328
	XL 500	1984-				
	XR 500	1984-				
	CAMINO S 50	-19-			NE-8	329
	CBX 900 FII	-19-				
	CB 125 S	1979-	HOND-4D	327	NE-6	329
			HOND-4DP	327	NE-6P	329
			HOND-4I	327		
			HOND-4IP	327		
	CB 125 SI.	1982-	HOND-4I	327	NE-6	329
			HOND-4D	327	HOND-4D	327



FOR: PARA:	MODEL MODELO			PAG.		PAG.
HONDA	XL 125	1982-1983	HOND-4IP	327	NE-6P	329
					NE-8	329
			HOND-4DP	327	HOND-4DP	327
			HOND-4DP2	327	HOND-4DP2	327
	CB 125 T	1986-	HOND-4I	327	HOND-4I	327
	MTX 125 R	1986-	HOND-4IP	327	HOND-4IP	327
	SPACY SCOOT.	-19-				
	CB 125 T2	1982-	SUZU-13P	329	NE-6	329
			SUZU-4I	329	NE-6P	329
			SUZU-4IP	329		
			FAR-1D	327		
	CB 125 X	1982-	HOND-4I	327	NE-6	329
			FAR-1D	327		
	CBX 125	1982-1983	HOND-4IP	327	NE-6P	329
	CB 250 N	1986-	HOND-4D	327	NE-8	329
	CB 250 RS	1986-	HOND-4DP	327		
	CB 750 K	1979-				

Motocicleta
Motozikleta
Motos



Motorrad
Motociclos
Motocykli

FOR: PARA:	MODEL MODELO			PAG.		PAG.
---------------	-----------------	---	---	------	---	------



HONDA®						
		HOND-4IP1	327	HOND-4IP1	327	
CB 500S	1997-	HOND-24P	328	HOND-24P	328	
CBF 500	2004-2007					
CBF 600	2004-2007					
CBR 900 RR	1997-					
CBR 1000 F	1997-					
FORZA	2005-					
NTV 650	1997-					
NTV 650	1997-1998					
NX 650	1997-					
SFX 50	1997-					
SH 50	1997-					
SH 100	1997-					
SJ 100 BALI	1997-					
ST 1100	1997-					
CB 550 F	1979-1982			NE-6	329	
				NE-6P	329	
CB 650	-19-	HOND-4D	327			
		HOND-4DP	327			
CB 650 CUST	-19-	HOND-4D	327	NE-8	329	
CB 650 SC	-19-	HOND-4DP1	327			
		HOND-4DP2	327			
CB 750	1986-	HOND-4DP2	327	HOND-4DP2	327	
CX 500	1979-					
CB 750	1986-1991	HOND-19	328	HOND-19	328	
		HOND-19D	328	HOND-19D	328	
		HOND-19DP	328	HOND-19DP	328	
		HOND-19P	328	HOND-19P	328	
		HOND-4D	327	HOND-4D	327	
		HOND-4DP	327	HOND-4DP	327	
		HOND-4I	327	HOND-4I	327	
		HOND-4IP	327	HOND-4IP	327	
CB 750	1992-	HOND-4D	327	HOND-4D	327	
		HOND-4DP1	327	HOND-4DP1	327	
CB 750 F	1979-	HOND-7D	327	NE-6	329	
		HOND-7I	327	NE-6P	329	
CB 750 FO.	1978-	HOND-7I	327			
CB 1000	1993-	HOND-4D	327	HOND-4D	327	
CBR 900 RR	1994-1996	HOND-4DP1	327	HOND-4DP1	327	
		HOND-4DP2	327	HOND-4DP2	327	
		HOND-4I	327	HOND-4I	327	
		HOND-4IP1	327	HOND-4IP1	327	
CBR 1000	1992-	HOND-19	328	HOND-19	328	
		HOND-19D	328	HOND-19D	328	
		HOND-19DP	328	HOND-19DP	328	
		HOND-19P	328	HOND-19P	328	
		HOND-4D	327	HOND-4D	327	
		HOND-4DP1	327	HOND-4DP1	327	
		HOND-4DP2	327	HOND-4DP2	327	
		HOND-4I	327	HOND-4I	327	
		HOND-4IP1	327	HOND-4IP1	327	
CBX 125	1982-	HOND-4DP2	327	HOND-4DP2	327	
CBX 125	1983-1984	SUZU-13P	329	NE-6	329	
		FAR-1D	327	FAR-1D	327	
MH 125	1983-	SUZU-4I	329	NE-6P	329	
		FAR-1I	327	FAR-1I	327	
XL 125	1983-1984	SUZU-4IP	329	NE-8	329	

FOR: PARA:	MODEL MODELO			PAG.		PAG.
---------------	-----------------	---	---	------	---	------

HONDA®						
CBX 125	1984-	HOND-4D	327	HOND-4D	327	
		HOND-4DP	327	HOND-4DP	327	
		FAR-1D	327			
		FAR-1I	327			
CBX 900	1984-	HOND-19	328			
		HOND-19D	328			
		HOND-19DP	328			
		HOND-19P	328			
CBX 1000 S.S	-19-	HOND-4D	327	HOND-4D	327	
NTV 650	1984-1992	HOND-4DP	327	HOND-4DP	327	
ST 1100	-1991	HOND-4DP2	327	HOND-4DP2	327	
VF 400 F	1986-	HOND-4I	327	HOND-4I	327	
VFR 400 R	1986-	HOND-4IP	327	HOND-4IP	327	
XL 600	-1984					
CDI 125 6	1984-1986	HOND-4D	327	NE-8	329	
		HOND-4DP	327			
		HOND-4DP2	327			
CG 125	1993-	HOND-26DP1	328	HOND-26DP1	328	
CG 125	1993-2008	HOND-26P1	328	HOND-26P1	328	
ECONO POW.90	1993-					
CG 150	-19-	HOND-44DP		HOND-44DP		
		HOND-44P		HOND-44P		
CMX 450 SC.	-1991	SUZU-13P	329	SUZU-13P	329	
		SUZU-4I	329	SUZU-4I	329	
		SUZU-4IP	329	SUZU-4IP	329	
CN 250	-1991	HOND-4I	327	HOND-4I	327	
XL 250 R	-1991	HOND-4IP	327	HOND-4IP	327	
CN 250	1991-1994	HOND-19	328	HOND-19	328	
XL 250	-1991	HOND-19D	328	HOND-19D	328	
		HOND-19DP	328	HOND-19DP	328	
		HOND-19P	328	HOND-19P	328	
CR 250	-1991	HOND-19	328	HOND-19	328	
		HOND-19D	328	HOND-19D	328	
		HOND-19DP	328	HOND-19DP	328	
		HOND-19P	328	HOND-19P	328	
		HOND-4I	327	HOND-4I	327	
		HOND-4IP	327	HOND-4IP	327	
CRM 125	1990-	HOND-4D	327	HOND-4D	327	
NSR 125 F	1990-	HOND-4DP1	327	HOND-4DP1	327	
NSR 125 R	1990-	HOND-4DP2	327	HOND-4DP2	327	
NSR 125 R SP	1990-	HOND-4I	327	HOND-4I	327	
		HOND-4IP1	327	HOND-4IP1	327	
CRM 125	1990-1992	HOND-19	328	HOND-19	328	
MTX 200	-1989	HOND-19D	328	HOND-19D	328	
PK 50 DX WA.	1992-	HOND-19DP	328	HOND-19DP	328	
SA 50 M VIS.	1992-	HOND-19P	328	HOND-19P	328	
TRX 200	-1989					
XL 125	1990-					
XL 200	1990-1991					
CS 125	1982-	HOND-4DP2	327	HOND-4DP2	327	
		HOND-4I	327	NE-6	329	
		HOND-4IP	327	NE-6P	329	
		FAR-1D	327	FAR-1D	327	
CX 500	1979-1981	HOND-4D	327			
		HOND-4DP	327			
CX 500	1984-	HOND-4D	327	HOND-4D	327	
		HOND-4DP	327	HOND-4DP	327	

FOR: PARA:	MODEL MODELO			PAG.		PAG.
---------------	-----------------	---	---	------	---	------

HONDA®						
		HOND-4I	327	HOND-4I	327	
		HOND-4IP	327	HOND-4IP	327	
CX 500	1984-1987	HOND-19	328	HOND-19	328	
NTV 650	1984-1994	HOND-19D	328	HOND-19D	328	
NX 650	1991-1994	HOND-19DP	328	HOND-19DP	328	
ST 1100	1992-	HOND-19P	328	HOND-19P	328	
VF 400	1986-					
VFR 400	1986-					
VFR 750	1991-					
XL 600	1984-1985					
DYLAN 125	2004-	ZA-9P1	329	ZA-9P1	329	
PHANTEON 150	2003-					
PS 125I	2006-					
PS 150I	2006-					
SH 125I	2005-					
SH 150I	2006-					
GR	-19-	HOND-18DP	327	HOND-18DP	327	
GRX	-19-					
HORNET	1998-	HOND-43	328	HOND-43	328	
		HOND-43D	328	HOND-43D	328	
		HOND-43DP	328	HOND-43DP	328	
		HOND-43P	328	HOND-43P	328	
		HOND-28P	328			
LEAD 100	2003-					
MTX 125	1990-1992	HOND-19	328	HOND-19	328	
MX 125	1990-1992	HOND-19D	328	HOND-19D	328	
		HOND-19DP	328	HOND-19DP	328	
		HOND-19P	328	HOND-19P	328	
		HOND-4D	327	HOND-4D	327	
		HOND-4DP1	327	HOND-4DP1	327	
		HOND-4DP2	327	HOND-4DP2	327	
		HOND-4I	327	HOND-4I	327	
		HOND-4IP1	327	HOND-4IP1	327	
MTX 200 R	-1989	HOND-4D	327	HOND-4D	327	
TRX 200 SX	-1989	HOND-4DP	327	HOND-4DP	327	
XL 200	-1989	HOND-4DP2	327	HOND-4DP2	327	
XL 200 PD	-1989	HOND-4I	327	HOND-4I	327	
		HOND-4IP	327	HOND-4IP	327	
NAVI 110	2016-	HOND-36DP		HOND-36DP		
NH 50	-1991	AF-6D	327	NE-8	329	
PA 50 DLX	-1991					
PK 50 DX	-1991					
PX 50 S	-1991					
SA 50	-1991					
NX 125	1990-	HOND-4I	327	HOND-4I	327	
		HOND-4IP	327	HOND-4IP	327	
NXR 650 A.	1988-1990	HOND-4I	327	HOND-4I	327	
PC 800	1989-1991	HOND-4IP	327	HOND-4IP	327	
PK 50	1993-	HOND-25P2	327	HOND-25P2	327	
SA 50 P	1993-	HOND-4I	327	HOND-4I	327	
SH 50	1993-1996	HOND-4IP1	327	HOND-4IP1	327	
SFX 50	1994-1995	HOND-20	328			
SJ 50 BALI	1994-1995	HOND-20D	328			
		HOND-20DP	328			
		HOND-20P	328			
SH 50	1991-1993	VO-VBP1	329	HOND-30DP2	327	
				VO-VBP1	329	

FOR: PARA:	MODEL MODELO			PAG.		PAG.
---------------	-----------------	---	---	------	---	------

HONDA®						
				SUZU-13DP	329	
				SUZU-4D	329	
				SUZU-4DP	329	
VARIOUS MODELS	-	HOND-18P		HOND-18P		
		HOND-23		HOND-23		
		HOND-24DP		HOND-24DP		
		HOND-27D		HOND-27D		
		HOND-29DP		HOND-29DP		
		HOND-29P		HOND-29P		
		HOND-31P		HOND-31P		
		HOND-42P		HOND-42P		
		HOND-45D	329	HOND-45D	329	
		HOND-46D		HOND-46D		
		HOND-5D		HOND-5D		
		HOND-5I		HOND-5I		
		HOND-6D		HOND-6D		
		HOND-6I		HOND-6I		
		HOND-8D	327	HOND-8D	327	
		HOND-8I	327	HOND-8I	327	
		HOND-9I	327	HOND-9I	327	
VF 750 C	1982-1990	VO-VBP1	329	VO-VBP1	329	
		HOND-4D	327	HOND-4D	327	
		HOND-4DP	327	HOND-4DP	327	
		HOND-4DP2	327	HOND-4DP2	327	
VF 750 CU.	1982-	VO-VBP1	329	VO-VBP1	329	
VF 750 S	1982-	VO-VBP1	329	VO-VBP1	329	

Motocicleta
Motozikleta
Motos

Motorrad
Motociclos
Motocykli

FOR: PARA:	MODEL MODELO			PAG.		PAG.
KAWASAKI ©	EN 500	2000-2009				
	KLX 650	-19-				
	TWIN CAM	1992-				
	VN 1500	2002-2003				
	VN 1600	2003-2008				
	ZXR 400	1991-1994				
	ZXR 1100	1991-1992				
	ZZR 250	-19-				
	ZZR 600	-19-				
	ZZR 1100	1991-1992				
	550 LTD	1982-	KAW-3	330	KAW-3	330
	GPZ 250	-19-				
	GPZ 305	-19-				
	GPZ 450	-19-				
	GPZ 550	1982-1984				
	GPZ 600 R	-19-				
	GPZ 750	-19-				
	GPZ 750 R	-19-				
	GPZ 900 R	-19-				
	GPZ 1000	-19-				
	GPZ 1100	-19-				
	GPZ 1300	-19-				
	KL 250	-19-				
	KLR 250	-19-				
	VOYAGER	-19-				
	Z 250 C	-19-				
	Z 250 GP	-19-				
	Z 250 LTD	-19-				
	Z 305	-19-				
	Z 450	-19-				
	Z 550	1982-1984				
	Z 600	-19-				
	Z 750	-19-				
	Z 750 LTD	-19-				
	Z 750 TURBO	-19-				
	Z 900	-19-				
	Z 1000	-19-				
	Z 1100	-19-				
	Z 1300	-19-				
	900 Z1	-19-	KAW-4	330	KAW-4	330
	1000 GTR	1984-1991	KAW-3	330	KAW-5	330
	1300 Z	1986-1991	KAW-5	330	KAW-5P	330
	CS 250	1984-1986	KAW-5P	330		
	FX 400 R	1984-				
	GPZ 305	1984-				
	GPZ 550	1984-1990				
	GPZ 750	1984-1991				
	GPZ 900 R	-1986				
	GPZ 1000	1984-1991				
	GPZ 1100	1984-				
	GT 750	1984-1991				
	GTR 1000	1984-1991				
	KL 250	1984-1986				
	KLR 570	1984-1990				
	KLR 650	1980-1991				
	LTD 450	1984-				
	SR 650	1980-1991				

FOR: PARA:	MODEL MODELO			PAG.		PAG.
KAWASAKI ©	TENGAJ 650	1980-1991				
	VN 750 T.	1984-1991				
	Z 250	1984-				
	Z 305 B.	1984-				
	Z 400	1984-				
	Z 440	1984-				
	Z 550	1984-1990				
	Z 750	1985-1992				
	Z 1000 RZ	1984-1991				
	Z 1100	1984-				
	Z 1300	1986-1991				
	ZN 1300 V	1986-1991				
	ZR 550	1984-1990				
	ZX 550	1984-1990				
	ZX 1000	1984-1991				
	ZXR 750	1985-1992				
	AR 125	-1986		NE-6	330	
	KDX 175	-19-		NE-6P	330	
	KE 125	-1986				
	KE 175	-19-				
	KMX 125	-1986				
	KX 125	-1986				
	BN 125 ELIM.	2006-2007	KAW-6P	330	KAW-6P	330
	VN 1700	2009-				
	VN 2000	2004-2010				
	EJ 650	1999-2006		KAW-9P	330	
	EJ 800	2011-				
	Z 1000	2003-2005				
	ZRX 1100	1999-2000				
	ZRX 1200	2001-2006				
	EN 500	-1991	KAW-2I	329	KAW-2I	329
	ER 5	2003-	KAW-9P	330	KAW-9P	330
	ER 6	2006-2011				
	NINJA ZX- 6R	2003-2006				
	NINJA ZX- 7R	2003-				
	NINJA ZX- 9R	2003-2005				
	NINJA ZX-12R	2003-				
	ZR 7	1999-2005				
	ZZR 1200	2000-2005				
	EX250	1988-2009	KAW-9		KAW-9	
	GPZ500	1988-2009				
	GPZ550	1995-1998				
	GPZ750	1995-1998				
	KZ POLICE	1982-2005				
	KZ1000J	1982-				
	NINJA 750	1979-1992				
	NINJA ZX14	-2006				
	Z750S	-1999				
	ZRX11000	1999-2000				
	ZRX1200R	2001-2008				
	EX250	2008-	KAW-10DP		KAW-10DP	
	NINJA 250R	2008-	KAW-10P	330	KAW-10P	330
	GLX 1100	1993-	KAW-5	330	KAW-5	330
	GPX 600	1986-1990	KAW-5P	330	KAW-5P	330
	GPZ 500	1987-				
	GPZ 600	1986-1990				
	KDX 250 D	-19-				

FOR: PARA:	MODEL MODELO			PAG.		PAG.
KAWASAKI ©	KL 250	1986-				
	KLR 250	1986-1996				
	KX 250	1986-				
	LTD 450 C.	1986-				
	Z 650	1983-				
	ZL 600	1990-1992				
	ZZR 600	1990-1992				
	GPZ 400	-19-	KAW-3	330	KAW-3	330
	GPZ 550	-19-	KAW-4	330	KAW-4	330
	LTD 450	-19-	SUZU-13P	330		
	Z 400	-19-	SUZU-4I	330		
	Z 400 TW.	-19-	SUZU-4IP	330		
	Z 440 LTD	-19-				
	Z 550 LTD	-19-				
	GPZ 500 S	1994-	KAW-5P	330	KAW-5P	330
	KLE 500	1994-				
	GPZ 500 S	1994-2009	KAW-5	330	KAW-5	330
	KLE 500	1991-2007				
	GPZ 750	-1984	KAW-3	330		
	Z 400 F	1981-1982				
	Z 400 J	1981-1982				
	Z 750	1984-1985				
	KH 400	1978-	KAW-4	330	SUZU-13DP	330
	OH 400	1978-	SUZU-13DP	330		
	Z 400	1978-1981	SUZU-13P	330		
			SUZU-4D	330		
			SUZU-4DP	330		
			SUZU-4I	330		
			SUZU-4IP	330		
	KL 600 S	1986-1991	KAW-2D	329	KAW-2D	329
	KLR 600	1986-1991	KAW-2I	329	KAW-2I	329
	KLR 250	1985-1986	KAW-2I	329	KAW-2I	329
	KLR 250	1997-2010	KAW-7P	330		
	KLX 125	2010-2011				
	KLX 250	2008-2009				
	NINJA 500R	1993-1994				
	NINJA ZX- 6R	1993-2006				
	KLR 600	-19-	KAW-1D	329	KAW-1D	329
	Z 440	-19-	KAW-1I	329	KAW-1I	329
	Z 650 F	1984-1991				
	Z 650 S	1984-1991				
	Z 650 SR	1984-1991				
	KLR 600 S	1994-1999	KAW-7P	330	KAW-7P	330
	KLR 650	1994-1999				
	NINJA ZX- 9R	1994-2003				
	ZXR 750	1993-1994				
	ZZR 600	1994-2004				
	ZZR 1100	1993-1994				
	KLV 1000	2004-	SUZU-12DP	330	SUZU-12DP	330
	KLX250	2009-	KAW-7		KAW-7	
	NINJA ZX- 6R(ZX600F/G/J)	1995-2002				
	NINJA ZX-7,ZX-7R,ZX-7RR(ZX750)	1993-2003				
	SUPER SHERPA KL250G	2000-2003				
	VULCAN 1500 CLASSIC	2001-2005				

FOR: PARA:	MODEL MODELO			PAG.		PAG.
KAWASAKI ©	VULCAN 1500 CLASSIC	2005-2008				
	VULCAN 1500 DRIFTER	2001-2005				
	VULCAN 1500 NOMAD	2001-2005				
	ZX-6(ZX600D)(ZX600E)	1993-2002				
	ZX-9R(ZX900B/C/E/F)	1994-2003				
	ZZR600(ZX600E,ZX600J)	2003-2008				
	LDT 500	1995-	KAW-6DP	330	KAW-6DP	330
	VN 800	1995-2005				
	NINJA 250R	1990-2007	KAW-5	330		
	NINJA 600R	1990-1996	KAW-5P	330		
	NINJA ZX-11R	1993-2001				
	Z 500	1991-1998				
	Z 750	1992-1997				
	ZG 1000 CON.	1992-2006				
	ZRX 1100	1992-2000				
	SJ 50 BALI	1994-	KAW-5	330	KAW-5	330
			KAW-5P	330	KAW-5P	330
	VN 250	2000-	KAW-6DP	330	KAW-6DP	330
	VN 400	1999-2000				
	VN 1500	1987-2001				
	Z 250 A	1982-	KAW-2I	329		
	Z 250 C	1982-	KAW-8D	330		
	Z 250 J	1982-				
	Z 400	1981-1984	KAW-2I	329		
	Z 440 H	1982-	KAW-2D	329		
	Z 440 J	1982-	KAW-2I	329		
	Z 440 LTD	1982-				
	Z 500	1981-1991	KAW-3	330		
	Z 750	1998-2005	KAW-9P	330	KAW-9P	330
	ZL 600 ELI.	1997-	KAW-5	330		
			KAW-5P	330		
	ZXR 400	1990-1991	KAW-2D	329	KAW-2D	329
	ZXR 1100	1990-1991				
	ZZR 1100	1990-1991				
KTM ©	125 DUKE	2012-	KM-1P	331		
	RC 390	2015-				
	ER 5	2003-	ZA-9P1	331	ZA-9P1	331
	MODELOS	1988-	VO-VBP1	331	VO-VBP1	331
KYMCO ©	XCITING 250	2005-	KYM-3DP	331	KYM-3DP	331
	XCITING 300	2008-2009	KYM-3P	331	KYM-3P	331
	XCITING 500	2005-2009				
	AGILITY	2005-	KYM-1DP	331		
			KYM-1P	331		
	CX 50	1997-	HOND-4I	331	HOND-4I	331
	K 1250	1997-	HOND-4IP	331	HOND-4IP	331
	KB 50	1997-				
	SNIPER 50 DD	1997-				
	GRANDINK	2001-	KYM-2P	331		
	HEROISM	1997-	KYM-1DP	331	KYM-1DP	331
			KYM-1P	331	KYM-1P	331
	VARIOUS MODELS	-	KYM-2		KYM-2	

Motocicleta
Motozikleta
MotosMotorrad
Motociclos
Motocykli

FOR: PARA:	MODEL MODELO			PAG.		PAG.
---------------	-----------------	--	--	------	--	------

KYMCO®	KYM-2D				KYM-2D	
	KYM-2DP				KYM-2DP	

LAMBRETTA®	LUI 50	-19-			IMS-3	331
					IMS-3P	331
					NE-56	331

LAVERDA®	50 ATLAS	1986-1990	ZA-1	332	ZA-1	332
	50 GAUCHO	1986-	ZA-1P	332	ZA-1P	332
	125 CU RIDE	1986-1990				
	125 FORMULA	1986-1990				
	125 LESMO G	1986-1990				
	600 ATLAS O	-19-				
	1000 SFC	1986-				
	50 LZ	-19-	NE-8	332	NE-8	332
	125 GS LES.	1984-	ZA-1	332	ZA-1	332
	125 L ELEG.	1984-	ZA-1P	332	ZA-1P	332
	125 LB CUS.	1984-				
	125 LB SAB.	1984-				
	125 LB UNO	1984-				
	125 LZ CUS.	1984-				
	350 LESMO	1984-				
	V6 1000 R	-19-				
	125 LZ	1978-	NE-6	331	NE-6	331
			NE-8	332	NE-8	332
			FAR-1D	331	FAR-1D	331
	125 LZ C.	1978-	NE-6P	332	NE-6P	332
			FAR-1I	331		
	125 LZ S.	1978-	NE-8	332		
500 4T	-19-	SUZU-13P	332	NE-6	331	
		FAR-1D	331			
500 SFC	-19-	SUZU-4I	332	NE-6P	332	
		FAR-1I	331			
1000 JOTA	-19-	SUZU-4IP	332			
1000 JOTA120	-19-					
1000 RGS	-19-					
1200 TS	1978-					
1000	1978-	SUZU-13P	332	NE-6	331	
1200	1978-	SUZU-4I	332	NE-6P	332	
750	1978-	SUZU-4IP	332			
PHOENIX	2003-	ZA-8P	332	ZA-8P	332	

LINCE®	125 SERVETTE	-19-	AF-5D	332	CL-2I	332
	150 SERVETTE	-19-			CL-3I	332
	200 SERVETTE	-19-				

MAICO®	GM STAR 250E	-19-			CL-2I	332
	GM STAR 500E	-19-			CL-3I	332
	GM STAR SID.	-19-			NE-6	332
					NE-6P	332
				NE-8	333	

MALAGUTI®	50 MDX	1986-1991	ZA-1	333	ZA-1	333
	50 MEX	1986-1991	ZA-1P	333	ZA-1P	333
	50 MFX	1986-1991				
	50 MGX	1986-1991				
	CUSTOM	1986-1991				

FOR: PARA:	MODEL MODELO			PAG.		PAG.
---------------	-----------------	--	--	------	--	------

MALAGUTI®	FIFTY FULL	1986-				
	FIFTY HF 50	1986-1991				
	FIFTY TOP 50	1986-				
	RUNNER YLC	1986-1991				
	TOP 50	1986-1991				
	125	1986-			ZA-1	333
	125 RUNNER	1986-			ZA-1P	333
	CAVALCONE 80	-19-				
	CHOPPER 25	-19-				
	CHOPPER 40	-19-				
	CHOPPER 80	-19-				
	DRIBBLING	1986-				
	DROP	-19-				
	DUNE ES	1986-				
	DUNE KS	1986-				
	FIFTY	-19-				
	FIRE BIRD	-19-				
	GRIZLY UNO	-19-				
	MRX ENDURO	1986-				
	NEW DRIBLING	-19-				
	PULL CX	-19-				
	CENTRO SL	1994-	ZA-4DP	333	ZA-4DP	333
	CROSSER 50	1994-				
	F 10	1994-				
	PHANTOM	1994-				
	F 10 JET	1992-	YAMA-27	333	YAMA-27	333
			YAMA-27D	333	YAMA-27D	333
			YAMA-27DP	333	YAMA-27DP	333
			YAMA-27P	333	YAMA-27P	333
			YAMA-30P	333	YAMA-30P	333
	FIREFOX F15	1996-1997	ZA-9P	333	ZA-9P	333
	MADISON	2003-	ZA-9P	333	ZA-9P	333
	RS	1991-	ZA-4DP	333	ZA-4DP	333
	RST 50	1991-1992	ZA-13P	333	ZA-4DP	333
		ZA-4DP	333			
VARIOUS MODELS	1996-	ZA-9P2		ZA-9P2		

MALANCA®	125 MARKT	-19-	ZA-1	333	ZA-1	333
			ZA-1P	333	ZA-1P	333
	BIG	-19-			ZA-1	333
	GTS 4 4M	-19-			ZA-1P	333
	GTS 5	-19-				
LP	-19-					
LPRL	-19-					

MBK®	BOOSTER	1995-1997	ZA-4DP	333	ZA-4DP	333
	EVOLIS	1995-				
	FORTE	1995-				
	NEW SORRISO	1995-				
	BOOSTER	1998-	ZA-9P1	333	ZA-9P1	333
	KILIBRE	2003-				
	OVETTO	1998-				
	BOOSTER 50	-19-	YAMA-27	333	YAMA-27	333
	EVOLIS	-19-	YAMA-27D	333	YAMA-27D	333
	SCOOTER	-19-	YAMA-27DP	333	YAMA-27DP	333
	SORRISO	-19-	YAMA-27P	333	YAMA-27P	333
	TARGET	-19-	ZA-4DP	333	ZA-4DP	333

FOR: PARA:	MODEL MODELO			PAG.		PAG.
---------------	-----------------	--	--	------	--	------

MBK®	VARIOUS MODELS	1997-2004	ZA-9P2		ZA-9P2	
------	----------------	-----------	--------	--	--------	--

MBM®	BREEZE LUSSO	-19-			ZA-1	334
	BULL	-19-			ZA-1P	334
	CRAZY	-19-				
	PONY	-19-				
	SOGNO	-19-				

MONTESA®	250 ENDURO	-1991			CL-2I	334
	250 KING SC.	-1991			CL-3I	334
	348 TRIAL	-1991				
	360 ENDURO	-1991				
	CAPPRA 250	-1991				
	COTA 50	-1991				
	COTA 50 AR.	-1994				
	COTA 50 H20	-1994				
	COTA 123 C	-1991				
	COTA 125	-1991				
	COTA 200	-1991				
	COTA 242 T	-1991				
	COTA 247	-1991				
	COTA 250	-1991				
	COTA 304	-1991				
	COTA 307	-1991				
	COTA 330	-1991				
	COTA 335	-1991				
	COTA 348	-1991				
	COTA 349	-1991				
	COTA 350	-1991				

MORINI FRANCO®	GIULIETTA O.	-19-			ZA-1	334
	LEM	-19-			ZA-1P	334

MOTO GUZZI®	65 GT	1984-	IMS-5	334	NE-6	334
			ZA-1	335		
			ZA-1P	335		
	650 NTX	1984-	IMS-5P	334	NE-6P	334
	V 50	1990-			NE-8	334
	V 50 C	1984-				
	V 50 III	1990-				
	V 50 MONZA	1984-				
	V 65	1984-				
	V 65 C	1984-				
	V 65 FL.	1984-				
	V 65 II	1984-				
	V 65 LA.	1984-				
	V 65 SP	1984-				
	V 65 TT	1984-				
	V 75	1984-				
	125 BX	1986-			NE-8	334
	125 CUSTOM	1986-				
	125 TT	1986-				
	245	-19-				
	125 TURISMO	-19-			NE-6	334
	DINGO	-19-			NE-6P	334
	STORNELLO	-19-				

FOR: PARA:	MODEL MODELO			PAG.		PAG.
---------------	-----------------	--	--	------	--	------

MOTO GUZZI®	125 TURISMO	1981-	IMS-5	334	NE-8	334
	V 35	1984-	IMS-5P	334		
	V 35 C	1984-1986				

MOTO GUZZI®	V 35 F.	1984-				
	V 35 II	1984-				
	V 35 III	1984-				
	V 35 IMOLA	1984-				
	250 ELECTR.	-19-	FEM-2D	334	NE-8	334
		FEM-2I	334			

MOTO GUZZI®	250 TS	-19-	FEM-2D	334	NE-6	334
			FEM-2I	334	NE-6P	334
	350 GTS	-19-	FEM-2D	334	NE-6	334
		FEM-2I	334	NE-6P	334	

MOTO GUZZI®	350 NEVADA	1994-	ZA-1	335	ZA-1	335
	750 NEVADA	1994-	ZA-1P	335	ZA-1P	335

MOTO GUZZI®	750 NTX	1990-	ZA-1	335	NE-8	334
	V 75 NTX	1990-	ZA-1P	335		

MOTO GUZZI®	850 GT	1986-	FEM-ID	334	NE-6	334
			FEM-II	334	NE-6P	334
			FAB-1	334		

MOTO GUZZI®	850 LE MANS	1979-1981	FEM-ID	334	NE-6	334
			IMS-5	334		
			IMS-5P	334		

MOTO GUZZI®	850 T3	1979-1986	FEM-II	334	NE-6P	334
	850 T3 C.	1979-1981	SIP-3	334		

MOTO GUZZI®	750	1979-				
	850 LE MANS	1981-	IMS-5	334	NE-6	334
	850 T3 C.	1981-	IMS-5P	334	NE-6P	334



MOTO GUZZI®	850 T3-T4	1981-			NE-8	334
	V 35	1982-1984				



MOTO GUZZI®	V 35 II	1982-1984				
	V 35 IMOLA	1982-1984				



MOTO GUZZI®



Motocicleta
Motozikleta
Motos

Motorrad
Motociclos
Motocykli

FOR: PARA:	MODEL MODELO			PAG.		PAG.
MOTO GUZZI						
	350	1979-	IMS-5	334	NE-6	334
	500	-19-	IMS-5P	334	NE-6P	334
	BREVA	2003-	ZA-9P1	335	ZA-9P1	335
	CALIFOR. EV	2003-				
	V 11	2003-				
	FAL.SAHARA	-19-	FEM-ID	334		
	SP 1000 II	1984-	IMS-5	334	NE-6	334
	V 1000 CALI.	1984-	IMS-5P	334	NE-6P	334
	V 1000 CONV.	1984-				
	V 1000 GT	1984-				
	V 1000 SP	1984-				
	V 1000 SP II	1984-				
	V 7 SPORT	-19-	SIP-3	334	NE-6	334
					NE-6P	334
	V 1000 C.	1979-	FEM-ID	334	NE-6	334
			FEM-1I	334	NE-6P	334
			SIP-3	334		
	V 1000 G5	1979-	IMS-5	334	IMS-5	334
			IMS-5P	334	IMS-5P	334
	V 1000 I LE.	1984-	IMS-5	334	NE-8	334
			ZA-1	335		
			ZA-1P	335		
	V 1000 IDRO.	1984-	IMS-5P	334		
	V 1000 II L.	1984-				
MOTO MORINI						
	3 1/2 SPO.	1981-	FEM-ID	335	NE-6	335
	3 1/2 V	1981-	FEM-1I	335	NE-6P	335
	125 T	1981-				
	250	1981-				
	250 BIC	1981-				
	500 GV	-19-				
	500 KANGEROO	-19-				
	500 T/S	-19-				
	50 CORSARIO	-19-			NE-6	335
	125 CORSARIO	-19-			NE-6P	335
	250 KANGURO	1979-				
	250 STRADA	1979-				
	550	1979-				
	125 H	1984-	FEM-2D	335	ZA-1	335
	125 KJ	1984-	FEM-2I	335	ZA-1P	335
	350 COGUARO	1986-	AF-6D	335	ZA-1	335
	350 EXCALIB.	1986-			ZA-1P	335
	350 KANGURO	1986-				
	350 NEW YORK	1986-				
	350 XE	1986-				
	501 COGUARO	1986-				
	501 EXCALIB.	1986-				
	501 KANGURO	1986-				
	501 NEW YORK	1986-				
	500 CAMEL	-19-	AF-6D	335	NE-8	335
MOTOBECANE						
	125 LT	-19-	LAS-X	335	NE-6	335
	SUPERMOBY 51	-19-			NE-6P	335
MOTOBI						
	254	-19-	IMS-5	335	NE-8	336
			IMS-5P	335		



FOR: PARA:	MODEL MODELO			PAG.		PAG.
MOTOMEL						
	CGS2	2006-			MOT-1P	
	DAKAR 200	2006-			MOT-4P	
	HAWKER	2006-			MOT-2P	
	SKORPION	2006-			MOT-3P	
MOTRON						
	3/TRE-RCV	-19-			ZA-1	336
	MST	-19-			ZA-1P	336
	RA PL 4P	-19-				
	SU 3R ID	-19-				
	TAXI AP	-19-				
	TAXI ES 1D	-19-				
	COMPACT	1990-1991	ZA-1	336	ZA-1	336
	GL 4	1990-1991	ZA-1P	336	ZA-1P	336
	GTO	1990-1991				
	INVADER	1990-1991				
	SHOPPING	1990-1991				
	TAXI ES ID	1990-1991				
	TAXI KS SL	1990-1991				
MV AUGUSTA						
	125 S	-19-	FEM-1I	336		
	125 SPORT	-19-			FEM-1I	336
	350 SPORT	-19-			FEM-2I	336
	350 S	-19-	AF-7I	336	AF-7I	336
			AF-7IP	336	AF-7IP	336
	750 S	-19-	SUZU-13P	336	NE-6	336
			SUZU-4I	336	NE-6P	336
			SUZU-4IP	336		
			FAR-1D	336		
			FAR-1I	336		
MZ						
	TOUR	1994-	ZA-4DP	336		
NORTON						
	850 COMMANDO	-19-	UN-3	337		
			UN-FS	337		
OMC						
	CITY	-19-			ZA-1	337
	ELITE	-19-			ZA-1P	337
	ELITE SL	-19-				
	ELS-SL	-19-				
	EXCLAIM	-19-				
	HI TECH	-19-				
	MARINER-SL	-19-				
	MUDDY	-19-				
	MUDDY JUNIOR	-19-				
	WILD ELITE	-19-				
	WILD MS	-19-				
	WILD TIGRE	-19-				
OSSA						
	125	-19-	CAS-ID	337	NE-6	337
	250 ENDURO	-19-			NE-6P	337
	350 ENDURO	-19-				
	250 DESERT	-19-			CL-2I	337
	250 EXPLORER	-19-			CL-3I	337
	250 FUEGO	-19-				
	250 ORANGE	-19-				
	250 SUPER	-19-				
	250 TRIAL	-19-				



FOR: PARA:	MODEL MODELO			PAG.		PAG.
OSSA						
	250 TU	-19-				
	250 TURISMO	-19-				
	250 YO	-19-				
	350 EXPLORER	-19-				
	350 ORANGE	-19-				
	350 TRIAL	-19-				
	TRIAL 303	-19-				
	TRIAL JELLOW	-19-				
PERIPOLI						
	COLORADO	-19-			ZA-1	337
	DAY LXR/SA	-19-			ZA-1P	337
	DAY S 5/K	-19-				
	GIULIETTA	-19-				
	MINI L SAMIK	-19-				
	OXFORD	-19-				
	OXFORD ROAD	-19-				
	TIR	-19-				
	VAI MO3	-19-				
	VAI R	-19-				
	WILD	-19-				
PEUGEOT						
	BUXY	1994-1997	ZA-1	338	ZA-1	338
	FOR LUX	1994-1998	ZA-12	338	ZA-12	338
	SPEEDAKE	1995-1997				
	SQUAB	1995-1996				
	LOOXOR	2001-			NE-45	337
	LUDIX	2004-			NE-45P	337
	SPEEDFIGHT	1997-				
	SV GEO	1991-1995				
	TREKKER	1998-				
	VIVACITY	1999-				
	X-RACE	2003-				
	SC 50 L SCO.	-19-	SUZU-13P	338	SUZU-13P	338
	SC 80 L SCO.	-19-	SUZU-4I	337	SUZU-4I	337
	ST 50 L SCO.	-19-	SUZU-4IP	338	SUZU-4IP	338
	SV 125 SCO.	-19-				
	SQUAB	1997-	NE-45P	337		
	SV 50 GEO	1992-	NE-45	337	NE-45	337
	SV 80 GEO	1993-	NE-45P	337	NE-45P	337
	SV 125 GEO	1993-				
	ZENITH	1994-1996	ZA-12	338	ZA-12	338
PGO						
	COMET	2000-	PGO-2P	338		
	PMS	2000-				
	PMX	2000-				
	RODOSHOW	2000-				
	TREX	2000-				
	SCOOTER	-19-	PGO-1	338		
PIAGGIO						
	APE 600 MP	1979-1981			AF-6D	338
	APE CAR	-19-	AF-9D	338	FAB-1	338
	APE CAR P3	-19-	AF-9DP	338		
	APE CARP 601	-19-	AF-9I	338		
			AF-9IP	338		
			FEM-ID	338		
			FEM-1I	338		
	APE P 50	-19-	FEM-ID	338	NE-6	339



FOR: PARA:	MODEL MODELO			PAG.		PAG.
PIAGGIO						
	APE TM P 50	-19-	FEM-1I	338	NE-6P	339
			ZA-1	339		
			ZA-1P	339		
	APE TM 703	-19-	AF-9D	338	FAB-1	338
			AF-9DP	338		
			AF-9I	338		
			AF-9IP	338		
	BOSS 50	1986-			ZA-1	339
	BRAVO 50	1986-			ZA-1P	339
					ZA-2P	339
	CIAO 50	1986-				
	GRILLO 50	1986-				
	SI 50	1986-				
	BOXER 50	1982-1986			NE-8	339
	BRAVO 50	1982-1986			ZA-1	339
	CIAO 50	1982-1986			ZA-1P	339
	SI 50	1982-1986				
	BRAVO	1992-			ZA-1	339
					ZA-1P	339
	CARNABY	2007-			FI-13P1	338
	FLY	2005-2012				
	SKIPPER	1999-2000				
	VESPA	1996-				
	ZIP	2000-2011				
	CIAO	1992-			ZA-1	339
	GRILLO	1992-			ZA-1P	339
	SI	1992-				
	COSA 125	1988-	ZA-2P	339	ZA-2P	339
	COSA 150	1988-				
	COSA 200	1988-				
	VESPA 50 PK	1986-				
	VESPA FL 2	1986-				
	VESPA PLURI.	1986-				
	VESPA RUSH	1986-				
	COSA 125 MA	1992-	FI-1	338	FI-1	338
	COSA 150 MA	1992-	FI-1P	338	FI-1P	338
	COSA 2 125	1993-	ZA-2P	339	ZA-2P	339
	COSA 2 150	1993-				
	COSA 2 200	1993-				
	COSA 200 MA	1992-				
	VESPA 125 E	1984-				
	VESPA P 125	1984-1991				
	VESPA PX 125	1984-1991				
	VESPA PX 150	1984-1991				
	VESPA PX 200	1984-				
	FREE RL	1995-	ZA-7DP	339		
	HEXAGON 125	1994-1997	ZA-4DP	339	ZA-4DP	339
	NICA 125	-19-	AF-9D	338	FAB-1	338
			AF-9DP	338		
			AF-9I	338		
			AF-9IP	338		
			ZA-2P	339		
	NRG	2002-2005			ZA-7DP	339
	SKIPPER	1993-1998				
	TYPHOON	1994-2010				
	ZIP	1994-1999				
	NRG	2006-			ZA-9P	339



Motocicleta
Motozikleta
Motos

Motorrad
Motociclos
Motocykli

FOR: PARA:	MODEL MODELO			PAG.		PAG.
PIAGGIO ®	QUARTZ	1992-	ZA-2P	339	ZA-2P	339
	VESPA 50	1992-	ZA-7DP	339	ZA-7DP	339
	ZIP	1992-1993				
	SCATTO	-1991	ZA-13P	339	ZA-13P	339
	SFERA	1992-	ZA-2P	339	ZA-2P	339
	SFERA	1995-1998	ZA-7DP	339	ZA-7DP	339
	TOLEDO-SC	-19-		CL-2I	338	
				CL-3I	338	
	VARIOUS MODELS	-	ZA-7DP1		ZA-7DP1	
	VARIOUS MODELS	2006-2011	ZA-9P2		ZA-9P2	
	VESPA 50	1979-1983	FEM-1D	338	NE-6	339
			AF-5D	338		
			ZA-1	339		
			ZA-1P	339		
	VESPA 50 ES	1981-1983	FEM-1I	338	NE-6P	339
	VESPA 125 E	1981-1984			NE-6	339
	VESPA P 125X	1981-			NE-6P	339
	VESPA P 150X	1981-				
	VESPA P 200X	1981-				
	VESPA PX125E	1981-				
VESPA 125 ET	1979-	FEM-1D	338	ZA-1	339	
VESPA 200 PX	1979-	FEM-1I	338	ZA-1P	339	
VESPA P 150X	1979-1981					
VESPA 125ET3	-1979	FEM-1I	338	NE-6	339	
				NE-6P	339	
VESPA 150	1979-			NE-6	339	
VESPA 150 RA	1979-			NE-6P	339	
VESPA 150 SV	1979-					
VESPA P 80X	-19-			NE-6	339	
				NE-6P	339	
VESPA P 125	-19-	FI-1	338	FI-1	338	
VESPA PK 125	-19-	FI-1P	338	FI-1P	338	
		ZA-2P	339	ZA-2P	339	
VESPA PK 50	1984-1986	FI-1	338	FI-1	338	
VESPA PK 50S	1984-1986	FI-1P	338	FI-1P	338	
VESPA PX 200	1986-			NE-6	339	
				NE-6P	339	
RALEIGH ®	CICLI	-19-		LF-2	339	
	CYCLES	-19-		UN-FP	339	
RIZZATO ®	ATALA	1995-	ZA-4DP	339		
	HACKET AT12	1995-				
	HACKET RACI.	1995-				
SULKI ®	125	1992-	BH-4	340	BH-4	340
			ZA-1	340		
		ZA-1P	340			
	50	-1992				
SUZUKI ®	400 ENDURO	1978-	SUZU-13P	340		
	400 S	1978-	SUZU-4I	340		
	GT 350	1978-	SUZU-4IP	340		
	650 DJEBEL	-1991	SUZU-13P	340	SUZU-13P	340
	DR 125 S	-19-	SUZU-4I	340	SUZU-4I	340
	DR 400	1980-1985	SUZU-4IP	340	SUZU-4IP	340

FOR: PARA:	MODEL MODELO			PAG.		PAG.
SUZUKI ®	DR 600	1985-				
	RGT 125	-19-				
	TS 125 S	-19-				
	TS 125 X	-19-				
	ADDRESS	1992-	SUZU-11D	340	SUZU-11D	340
	DR 350 SE	1994-	SUZU-11DP	340	SUZU-11DP	340
	ADDRESS 100	1994-	SUZU-11D	340	SUZU-11D	340
	DR 650	1992-	SUZU-11DP	340	SUZU-11DP	340
	GS 400	1993-				
	GS 500	1989-				
	GS 750	1991-				
	GSF 400	1993-				
	GSF 500 EP	1993-				
	GSF 600	1995-				
	GSX 600	1989-1997				
	GSX 750	1988-				
	GSX 1100 92	1992-				
	GSXR 750	1989-1996				
	GSXR 1100	1990-				
	RF 600 R	1993-				
	RF 900 R	1994-				
	RG 125	1995-				
	RS 650	1991-				
	RV 750	1989-				
	VS 800	1992-				
	VS 1400	1990-				
	VX 800	1990-				
	AH 50	1991-	YAMA-20I	341	YAMA-20I	341
	CP 50	1991-	YAMA-24IP	341	YAMA-24IP	341
			YAMA-28P	341	YAMA-28P	341
	AJ 50 ZZ	1995-	ZA-4DP	341	ZA-4DP	341
	AP 50	1995-				
	AN 125	1995-	YAMA-23DP	341	NE-8	340
	VS 600 GL	1995-	YAMA-23IP	341		
	VS 800 GL	1995-				
	CC 1	-19-	SUZU-13P	340	NE-8	340
	RV 90	-19-	SUZU-4I	340		
			SUZU-4IP	340		
	DL 1000	2003-	SUZU-12DP	340	SUZU-12DP	340
	GSXR 1000	2003-				
	SV 650 S	2003-				
	SV 1000 S	2003-				
	DR 125 SE	1995-	YAMA-20D	341	NE-8	340
	LS 650	1995-	YAMA-20I	341		
	VS 1400 GLP	1995-	YAMA-20IP	341		
	DR 250 S	1984-	SUZU-13P	340	SUZU-13P	340
	DR 500	1984-1986	SUZU-4I	340	SUZU-4I	340
	DR 650	1990-1991	SUZU-4IP	340	SUZU-4IP	340
	DR 750 BIG	1988-1991				
	DR 800 SL	1990-				
	GS 125 ES	1984-				
	GS 550	1984-1985				
	GS 850	1980-1982				
	DR 350	1997-	YAMA-20I	341		
	DR 350 S	1993-	YAMA-20D	341	NE-8	340
	DR 350 SM	1992-	YAMA-20I	341		
	DR 350 SN	1992-	YAMA-24DP	341		

FOR: PARA:	MODEL MODELO			PAG.		PAG.
SUZUKI ®	VS 750 J.	-19-	YAMA-24IP	341		
			YAMA-28P	341		
	DR 650 RSE	1995-	SUZU-12DP	340	SUZU-12DP	340
	GS 500 E	1995-				
	GSF 600	1995-				
	GSXR 750 SP	1995-				
	GSXR 750 W	1995-				
	GSXR 1100	1995-				
	G 450 L	1980-	SUZU-5	340	SUZU-5	340
	GN 400	1985-	SUZU-5P	340	SUZU-5P	340
	GNX 250	1985-1991				
	GR 650	1982-				
	GS 450	1980-				
	GS 500	1984-1989				
	GS 550	1982-1984				
	GS 750	1982-1987				
	GS 850	1982-1985				
	GSX 250 S	1985-1991				
	GSX 400	1985-				
	GSX 500	1989-				
	GSX 550	1985-				
	GSXR 1100	1981-				
	LS 650	1982-				
	LT 250 A	1985-1991				
	RG 250 R	1985-1991				
	RGV 250	1985-1991				
	GS 400 T	-19-	SUZU-13P	340		
GT 500	1978-	SUZU-4I	340			
		SUZU-4IP	340			
GS 500 F	2004-	SUZU-12DP	340	SUZU-12DP	340	
GSF BANDIT	2004-					
GSX R1300	2004-					
GZ 250	2004-					
LR GSX 600	2004-					
SV 650	2004-					
SV 750	2004-					
VL 800	2004-					
V-STROM 650	2004-					
V-STROM 1000	2004-					
VZ 1600	2004-					
GS 1000	1982-1985	SUZU-13P	340	SUZU-13P	340	
GSX 1100	1981-1985	SUZU-4I	340	SUZU-4I	340	
RG 500	1985-	SUZU-4IP	340	SUZU-4IP	340	
		SUZU-5	340	SUZU-5	340	
		SUZU-5P	340	SUZU-5P	340	
GSX 600	1998-2006			SUZU-12D		
GSX 1300 HA.	1999-2006			SUZU-12DP	340	
GSX 650	2008-					
GSX 1200	1999-2000					
GSX 1400	2002-2005					
GZ 125	1998-					
RV 125	2003-					
XF 650	1997-2001					
GSX 750	1981-1987	SUZU-13P	340	NE-8	340	
		SUZU-4I	340	SUZU-13P	340	
		SUZU-4IP	340	SUZU-4I	340	
		SUZU-5	340	SUZU-4IP	340	

FOR: PARA:	MODEL MODELO			PAG.		PAG.
SUZUKI ®			SUZU-5P	340	SUZU-5	340
					SUZU-5P	340
	GSX 750	1988-2006			SUZU-12D	
					SUZU-12DP	340
	GSXR 600	1997-	SUZU-12DP	340		
	GSXR 750	1997-				
	GT 550	1978-	SUZU-3I	340		
	GT 750	1978-				
	INTRUDE.1400	1993-	YAMA-19D	341	NE-8	340
	VS 800 GL	1993-1995	YAMA-19DP	341		
			YAMA-19I	341		
			YAMA-19IP	341		
			YAMA-23DP	341		
			YAMA-23IP	341		
			YAMA-29P	341		
	KATANANA	1997-	ZA-4DP	341		
	KATANANA R	2004-	ZA-9P1	341	ZA-9P1	341
	TL 1000	1997-2002			SUZU-12D	
	TU 125	1999-			SUZU-12DP	340
	TU 250	1997-2001				
	VARIOUS MODELS	-	SUZU-12P		SUZU-12P	
			SUZU-21P	340	SUZU-21P	340
			YAMA-20DP		YAMA-20DP	
	VS 750 INT.	1986-	YAMA-18D	341	YAMA-18D	341
			YAMA-18DP	341	YAMA-18DP	341
			YAMA-18I	341	YAMA-18I	341
			YAMA-18IP	341	YAMA-18IP	341
			YAMA-19D	341	YAMA-19D	341
		YAMA-19DP	341	YAMA-19DP	341	
		YAMA-19I	341	YAMA-19I	341	
		YAMA-19IP	341	YAMA-19IP	341	
		YAMA-20D	341	YAMA-20D	341	
		YAMA-20I	341	YAMA-20I	341	
		YAMA-20IP	341	YAMA-20IP	341	
		YAMA-22DP	341	YAMA-22DP	341	
		YAMA-22IP	341	YAMA-22IP	341	
		YAMA-23DP</				

Motocicleta
Motozikleta
MotosMotorrad
Motociclos
Motocykli



FOR: PARA:	MODEL MODELO			PAG.		PAG.		
SWM ®	WPM 1	-19-			NE-6	341		
					NE-6P	341		
TESTI ®	CRICHET PULL	-19-			NE-6	342		
					NE-6P	342		
TRIUMPH ®	AMERICA	2006-	TRP-1D			342		
	BONNEVILLE	2006-	ZA-9P1			342		
	DAYTONA	2006-						
	ROCKET III	2006-						
	SCRAMBLER	2006-						
	SPEEDMASTER	2006-						
	SPRINT ST	2006-						
	THRUXTON	2006-						
	TIGER	2006-2009						
	TRIDENT		-19-	UN-3	342	NE-6	342	
						NE-6P	342	
			UN-FS	342				
VARIOUS MODELS			TRP-2		TRP-2			
VARIOUS BRANDS	VARIOUS MODELS		AS-19D	342	AS-19D	342		
					BUR-6	342	BUR-6	342
					DAL-1P		DAL-1P	
					LAS-Y		TIT-7D	343
					TIT-7D	343		
YAMAHA ®	250 COMPETI.	-19-	YAMA-3I	343	YAMA-3I	343		
	400	-19-	YAMA-14I	343	YAMA-14I	343		
	RD 400	-19-	YAMA-15D	343	YAMA-15D	343		
			YAMA-15I	343	YAMA-15I	343		
	400 BICILIN.	-19-	YAMA-17D	343	YAMA-17D	343		
			YAMA-17I	343	YAMA-17I	343		
	500	1979-	YAMA-9I	343	YAMA-9I	343		
	500 ENDURO	1979-	YAMA-14I	343	YAMA-14I	343		
	RD 500	1979-						
	TT 350	1995-						
	600 ACERBIS	1980-	YAMA-14D	343	YAMA-14D	343		
	OHC 650	1980-	YAMA-14I	343	YAMA-14I	343		
	AEROX	1998-	ZA-9P1	345	ZA-9P1	345		
	NEOS	1998-						
	VERSITY 300	2003-						
	AXIS	1995-	ZA-4DP	345	ZA-4DP	345		
	BREEZE	1995-						
	SPY	1995-						
	BL 125 BE.	1984-1991		YAMA-18D	343	NE-8	343	
				YAMA-21I	344	YAMA-21I	344	
	DT 125 BA.	1984-1991		YAMA-18DP	344			
				YAMA-21IP	344	YAMA-21IP	344	
	DT 125 BB.	1984-1991		YAMA-18I	343			
	DT 125 CF.	1984-1991		YAMA-18IP	344			
	DT 125 R	1984-1986		YAMA-19D	343			
	RD 350	1984-1991		YAMA-19DP	344			
	RT 125 LL	1984-1991		YAMA-19I	343			
	SCROW 225	1984-1991		YAMA-19IP	344			
	SR 250	1984-1991		YAMA-20D	343			
	TDR 125	1984-1991		YAMA-20I	343			



FOR: PARA:	MODEL MODELO			PAG.		PAG.
YAMAHA ®	TDR 250	1984-1991	YAMA-20IP	344		
			YAMA-22DP	344		
	TZR 250	1984-1991	YAMA-22IP	344		
	XS 350	1984-1991	YAMA-23DP	344		
	XT 600	1984-1991	YAMA-23IP	344		
	XT 600 4V.	1984-1991	YAMA-24DP	344		
	XT 600 TE.	1984-1991	YAMA-24IP	344		
	XT 600 Z-ZA	1984-1991	YAMA-28P	344		
	YZ 125 LC	1984-1991	YAMA-29P	344		
	YZ 250 LC	1984-1991				
BL 125 BE.		1991-	YAMA-18D	343	NE-8	343
			YAMA-21I	344		
DT 125 BA.	1991-		YAMA-18DP	344		
			YAMA-21IP	344		
DT 125 BB.	1991-		YAMA-18I	343		
DT 125 CF.	1991-		YAMA-18IP	344		
DT 125 R	1991-1992		YAMA-19D	343		
RD 350	1991-		YAMA-19DP	344		
RD 350 LC	1991-		YAMA-19I	343		
RT 125 LL.	1991-		YAMA-19IP	344		
SCROW 225	1991-		YAMA-20D	343		
SR 250	1991-		YAMA-20I	343		
TDR 125	1991-1992		YAMA-20IP	344		
TDR 250	1991-					
TT 350	1991-1995					
TZR 125 R	1991-1992					
TZR 250	1991-					
XT 600	1991-					
XT 600 4V.	1991-					
XT 600 TE.	1991-					
XT 600 Z-ZA	1991-					
YZ 125 LC	1991-					
YZ 250 LC	1991-					
BREEZE	1994-		ZA-4DP	345	ZA-4DP	345
BT 1100 BU.	2003-2005		ZA-9P1	345	ZA-9P1	345
CR 50 Z	1992-		YAMA-27	344	YAMA-27	344
CT 50 S	1992-		YAMA-27P	344	YAMA-27P	344
SCOOTER MBK	1991-					
CT 50 SS	1995-		YAMA-27DP	344	YAMA-27DP	344
			YAMA-27P	344	YAMA-27P	344
DT 125	-1985		YAMA-3D	343	YAMA-3D	343
DT 125 LC.	-1985		YAMA-3I	343	YAMA-3I	343
DT 125	1992-		YAMA-18D	343	YAMA-18D	343
DT 125 B	1992-		YAMA-18I	343	YAMA-18I	343
DT 125 R	1992-		YAMA-19D	343	YAMA-19D	343
DT 125 Z	1992-		YAMA-19I	343	YAMA-19I	343
TT 600	1993-		YAMA-20D	343	YAMA-20D	343
TT 600 S	1991-		YAMA-20I	343	YAMA-20I	343
TZR 125 R	1992-		YAMA-22DP	344	YAMA-22DP	344
TZR 125 RSP	1992-		YAMA-22IP	344	YAMA-22IP	344
XT 600 A	1993-		YAMA-23DP	344	YAMA-23DP	344
XT 600 E	1991-		YAMA-23IP	344	YAMA-23IP	344
XT 600 ZA	1991-1992		YAMA-24DP	344	YAMA-24DP	344
			YAMA-24IP	344	YAMA-24IP	344
			YAMA-28P	344	YAMA-28P	344
			YAMA-29P	344	YAMA-29P	344
DT 125 CO.	1986-1992		ZA-1	345	ZA-1	345

FOR: PARA:	MODEL MODELO			PAG.		PAG.
YAMAHA ®	DT 125 LC.	1986-1992	ZA-1P	345	ZA-1P	345
			YAMA-18D	343	YAMA-18D	343
			YAMA-18DP	344	YAMA-18DP	344
DT 125 R	1986-1991		YAMA-18I	343	YAMA-18I	343
			YAMA-18IP	344	YAMA-18IP	344
			YAMA-19D	343	YAMA-19D	343
			YAMA-19DP	344	YAMA-19DP	344
			YAMA-19I	343	YAMA-19I	343
			YAMA-19IP	344	YAMA-19IP	344
			YAMA-20D	343	YAMA-20D	343
			YAMA-20I	343	YAMA-20I	343
			YAMA-20IP	344	YAMA-20IP	344
			YAMA-22DP	344	YAMA-22DP	344
			YAMA-22IP	344	YAMA-22IP	344
			YAMA-23DP	344	YAMA-23DP	344
			YAMA-23IP	344	YAMA-23IP	344
			YAMA-24DP	344	YAMA-24DP	344
			YAMA-24IP	344	YAMA-24IP	344
			YAMA-28P	344	YAMA-28P	344
			YAMA-29P	344	YAMA-29P	344
DT 250	-19-		YAMA-14D	343	YAMA-14D	343
DT 250 MX	-19-		YAMA-14I	343	YAMA-14I	343
RD 250	-19-		YAMA-15D	343	YAMA-15D	343
			YAMA-15I	343	YAMA-15I	343
			YAMA-3D	343	YAMA-3D	343
			YAMA-3I	343	YAMA-3I	343
FJ 1100	1984-		YAMA-21I	344	YAMA-21I	344
FJ 1200	1984-		YAMA-21IP	344	YAMA-21IP	344
FS 1200	1984-					
FZ 600	1984-					
FZ 600 GE.	1984-					
FZ 750 A-R	1984-					
FZR 600	1992-					
FZR 1000	1984-					
FZR 1000 E.	1984-					
FZX 750	1984-					
GENESIS FZR	1992-					
RD 500 YP.	1984-					
SUPER T. 750	1992-					
TDM 850	1991-					
TT 350	1984-1991					
TT 600 S	1984-1991					
XJ 400	1984-					
XJ 600 N	1984-					
XJ 650 T	1984-					
XJ 650 TU.	1984-					
XJ 750 N	1984-					
XJ 750 S.	1984-					
XTZ 750	1984-					
XTZ 750 T.	1984-					
XV 500 SE	1984-					
XV 750 SE	1984-					
XV 1000 V.	1984-					
XV 1100	1984-					
FRZ 600	1995-		YAMA-26	344	YAMA-26	344
FRZ 600 R	1994-		YAMA-26D	344	YAMA-26D	344
GTS 1000	1993-		YAMA-26DP	344	YAMA-26DP	344

FOR: PARA:	MODEL MODELO			PAG.		PAG.
YAMAHA ®	GTS 1000 ABS	1993-	YAMA-26P	344	YAMA-26P	344
	TDM	1996-				
	TDM 850	1995-				
	TRX 850	1995-				
	XJ 600 E	1995-				
	XJ 600 S D.	1995-				
	XJ 900 S D.	1995-				
	XT 500	1979-1984				
	XT 600 E	1995-				
	XTZ 660	1994-				
	XVS 110 D.S.	1998-				
	XVS 650	1996-				
	XVZ 1300	1996-				
	YP 250 MAJES	1996-				
	YZF 600	1996-				
	YZF 750 R	1993-				
	YZF 750 SP	1993-				
	YZF 1000	1996-				
	FS 1	-1986	YAMA-16D	343	YAMA-16D	343
	RD 125	-1986	YAMA-16I	343	YAMA-16I	343
			YAMA-3D	343	YAMA-3D	343
			YAMA-3I	343	YAMA-3I	343
	FZ 400	1984-	YAMA-18D	343	NE-8	343
	FZR 400	1984-	YAMA-18DP	344		
	FZR 600	1984-1992	YAMA-18I	343		
	RD 350 LC	1984-1991	YAMA-18IP	344		
	RD 550	1984-	YAMA-19D	343		
	SR 2					

Motocicleta
Motozikleta
MotosMotorrad
Motociclos
Motocykli

FOR: PARA:	MODEL MODELO			PAG.	
YAMAHA®					
	YAMA-26DP	344	YAMA-26P	344	
	YAMA-26P	344			
	YAMA-29P	344			
FZX 750	1995-	YAMA-18D	343	NE-8	343
		YAMA-22DP	344		
MAJESTY 250	2005-	ZA-9P1	345	ZA-9P1	345
RD 50 M	-19-	YAMA-14D	343	YAMA-14D	343
XT 50	-19-	YAMA-14I	343	YAMA-14I	343
RD 350	-19-	YAMA-3D	343	YAMA-3D	343
		YAMA-3I	343	YAMA-3I	343
		YAMA-9D	343	YAMA-9D	343
		YAMA-9I	343	YAMA-9I	343
		YAMA-17D	343	YAMA-17D	343
		YAMA-17I	343	YAMA-17I	343
RD 500 LC	1984-	YAMA-18D	343	NE-8	343
XJ 550	1984-	YAMA-18DP	344	YAMA-21I	344
XS 400	1984-	YAMA-18I	343	YAMA-21IP	344
		YAMA-18IP	344		
		YAMA-19D	343		
		YAMA-19DP	344		
		YAMA-19I	343		
		YAMA-19IP	344		
		YAMA-20D	343		
		YAMA-20I	343		
		YAMA-20IP	344		
		YAMA-21I	344		
		YAMA-21IP	344		
		YAMA-22DP	344		
		YAMA-22IP	344		
		YAMA-23DP	344		
		YAMA-23IP	344		
		YAMA-24DP	344		
		YAMA-24IP	344		
		YAMA-28P	344		
		YAMA-29P	344		
RS 125 C.	-1986	YAMA-5D	343	YAMA-5D	343
		YAMA-5I	343	YAMA-5I	343
SR 500 G	1979-1984	YAMA-14I	343	NE-8	343
		YAMA-14D	343		
SR 500 S	1979-1984				
XT 500	1979-1984				
TDR 125	1992-	YAMA-18I	343	ZA-1	345
TDR 125 R	1992-	YAMA-18IP	344	ZA-1P	345
TDR 125 R	1990-1991	YAMA-19I	343	ZA-1	345
		YAMA-19IP	344	ZA-1P	345
TT 600	1994-	YAMA-20D	343	YAMA-20D	343
TT 600 E	1994-				
XT 600 A	1994-				
XT 600 E	1994-				
TT 600	1995-	YAMA-20I	343	YAMA-20I	343
XT 600 A	1995-	YAMA-24IP	344	YAMA-24IP	344
XT 600 E	1995-	YAMA-28P	344	YAMA-28P	344
TW 200	1995-	YAMA-19I	343	NE-8	343
		YAMA-23IP	344		
		YAMA-29P	344		
TX 650	1979-	YAMA-3D	343	YAMA-3D	343
TX 750	1979-	YAMA-3I	343	YAMA-3I	343

FOR: PARA:	MODEL MODELO			PAG.		PAG.
YAMAHA®						
V MAX 86	1984-	YAMA-21I	344	YAMA-21I	344	
VMX 12 N	1984-	YAMA-21IP	344	YAMA-21IP	344	
XZV 12 T	1984-	YAMA-18I	343	YAMA-18I	343	
XZV 12 TD	1984-	YAMA-18IP	344	YAMA-18IP	344	
XZV 13 TD	1984-	YAMA-22DP	344	YAMA-22DP	344	
		YAMA-22IP	344	YAMA-22IP	344	
VARIOUS MODELS	-	YAMA-10D		YAMA-10D		
		YAMA-10I		YAMA-10I		
		YAMA-11D		YAMA-11D		
		YAMA-11I		YAMA-11I		
		YAMA-12D		YAMA-12D		
		YAMA-12I		YAMA-12I		
		YAMA-1D		YAMA-1D		
		YAMA-1I		YAMA-1I		
		YAMA-20DP		YAMA-20DP		
		YAMA-25DP		YAMA-25P		
		YAMA-25P		YAMA-2D		
		YAMA-2D		YAMA-2I		
		YAMA-2I		YAMA-32DP	344	
		YAMA-32DP	344	YAMA-33P1		
		YAMA-33P1		YAMA-34	344	
		YAMA-34	344	YAMA-34D	344	
		YAMA-34D	344	YAMA-36DP	345	
		YAMA-36DP	345	YAMA-4D		
		YAMA-4D		YAMA-6D		
		YAMA-6D		YAMA-6I		
		YAMA-6I		YAMA-7D		
		YAMA-7D		YAMA-7I		
		YAMA-7I		YAMA-8D		
		YAMA-8D		YAMA-8I		
		YAMA-8I				
VARIOUS MODELS	2005-	ZA-9P2		ZA-9P2		
XC 125 CYGN.	1995-	YAMA-18D	343	YAMA-18D	343	
		YAMA-22DP	344	YAMA-22DP	344	
XS 500	1979-	YAMA-13D	343	YAMA-13D	343	
		YAMA-13I	343	YAMA-13I	343	
		YAMA-14I	343	YAMA-14I	343	
XS 500 B	1979-	YAMA-3D	343	YAMA-3D	343	
		YAMA-3I	343	YAMA-3I	343	
		YAMA-9D	343	YAMA-9D	343	
		YAMA-9I	343	YAMA-9I	343	
XS 500 EV.	1985-	YAMA-13D	343	YAMA-13D	343	
		YAMA-13I	343	YAMA-13I	343	
XS 750	1979-	YAMA-13I	343	YAMA-13I	343	
XS 1100	1984-	YAMA-13D	343	NE-8	343	
XS 1100 S	1984-	YAMA-13I	343			
XT 250	1990-	YAMA-17I	343	NE-8	343	
YPUS 125	1990-					
XT 400	-19-	YAMA-14D	343	NE-8	343	
YSR 50	1990-	YAMA-18D	343	NE-8	343	
		YAMA-18I	343			
		YAMA-22DP	344			
		YAMA-22IP	344			
YZF-R3	2015-	YAMA-37D	344	YAMA-37D	344	

Guide

USER GUIDE FOR THIS CATALOGUE. BRAND INDEX

Guía de uso de este catálogo.
índice de marcas

Katalogo hau erabiltzeko jarraibidea.
Marken aurkibidea

Guide d'utilisation du catalogue.
Index des marques

Leitfaden für die Nutzung dieses
Katalogs. Markenverzeichnis

Guia de Utilização deste catálogo.
Índice de marcas

Instrukcja korzystania z niniejszego
katalogu. Spis marek

KEY JMA. CATALOGUE C.12

The keys that appear in this catalogue are JMA parts manufactured by Alejandro ALTUNA S.A. or one of its subcontractors. They are designed for cylinders and locks made by the manufacturers whose trademarks are indicated in this catalogue. In accordance with legal requirements relating to industrial property rights, the trademarks or trade names indicated in this catalogue are the exclusive property of the manufacturers of the cylinders and locks, as well as automobile manufacturers, other constructors, distributors and users. The aforementioned trademarks or trade names are indicated simply for information purposes so that the lock to which our parts correspond can be recognised quickly and easily.

This catalogue is for the exclusive use of professional key copiers who use JMA parts. Data referring to the products in this catalogue are indicative in nature. Although the basic characteristics are maintained at all times, we reserve the right to make, without previous notice, any technical, aesthetic or other types of changes involved in the development of the products in question. Some of the keys in this new catalogue could be received either with the JMA reference and trademark or with another trademark from the ALTUNA group.

LLAVES JMA. CATÁLOGO C.12

Las llaves que aparecen en este catálogo son piezas JMA fabricadas por Alejandro ALTUNA S.A. o un subcontratista de éste. Están diseñadas para cilindros y cerraduras de los fabricantes cuyas marcas se indican en este catálogo. Conforme a las disposiciones legales vigentes relativas a la propiedad industrial, las marcas o nombres comerciales indicados en este catálogo son propiedad exclusiva de los fabricantes de cilindros y cerraduras, así como de los fabricantes de automóviles, otros constructores, distribuidores y usuarios. Dichas marcas o nombres comerciales se indican en calidad simplemente informativa con el fin de reconocer con rapidez la cerradura a la que corresponden nuestras piezas.

Este catálogo está reservado exclusivamente a profesionales de la reproducción de llaves que utilizan piezas JMA. Los datos referentes a los productos de este catálogo tienen carácter indicativo. Manteniendo siempre las características básicas, nos reservamos el derecho de realizar, sin previo aviso, modificaciones técnicas, estéticas o de otro tipo, por razones de evolución de los productos en cuestión. Algunos modelos que están en este nuevo catálogo podrán recibirlos tanto con la marca y la referencia JMA como con otra marca del grupo ALTUNA.

JMA GILTZAK. KATALOGO C.12

Katalogo honetan ageri diren giltzak Alejandro ALTUNA SA enpresak edo honek kontratatutako beste enpresa batek egindako JMA piezak dira. Katalogoan zehazten diren marken fabrikatzaileen zilindro eta sarrailatarako diseinatuta daude. Jabetza industrialari buruz indarrean dauden lege-xedapenekin bat etorriz, katalogo honetan zehaztutako merkatariza-markak edo izenak zilindro eta sarrailen fabrikatzaileen eta beste eraikitzaile, banatzaile eta erabiltzaile batzuen jabetza eskusibokoak dira. Merkataritza-marka edo izen horiek zehaztasun gehiago emateko adierazten dira, gure piezak zein sarrailari dagozkion beharrez ikusi ahal izateko.

Katalogo hau giltzen kopiak egiteko JMA piezak erabiltzen dituzten profesionalentzako da soilik. Katalogo honetako produktuei buruzko datuek izaera adierazgarria dute. Oinarrizko ezaugarriak gordez, produktuen bilakaeraren ondoriozko aldaketa teknikoak, estetikoak edo bestelakoak egiteko eskubidea dugu, aurretik horren berri eman beharrik gabe. Katalogo berri honetan dauden eredueta batzuk JMA marka eta erreferentziarekin nahiz ALTUNA taldeko beste marka batekin jaso ahal izango dira.

CLÉS JMA. CATALOGUE C.12

Les clés figurant dans ce catalogue sont des pièces JMA fabriquées par Alejandro ALTUNA S.A. ou l'un de ses sous-traitants. Elles sont conçues pour les cylindres et les serrures des fabricants dont les marques figurent dans ce catalogue. Conformément aux dispositions légales en vigueur en matière de propriété industrielle, les marques ou les dénominations commerciales figurant dans ce catalogue sont la propriété exclusive des fabricants des cylindres et des serrures, mais aussi des constructeurs automobiles, des autres fabricants, distributeurs et utilisateurs. Ces marques et dénominations commerciales ne sont fournies qu'à titre d'information dans le but de pouvoir rapidement trouver la serrure à laquelle correspondent nos pièces.

Ce catalogue est destiné exclusivement aux professionnels de la reproduction de clés qui utilisent des pièces JMA. Les renseignements concernant les produits de ce catalogue ne sont fournis qu'à titre d'information. Tout en conservant les caractéristiques de base, nous nous réservons le droit de réaliser, sans préavis, des modifications techniques, esthétiques ou d'autres types pour des raisons d'évolution des produits concernés. Certains des modèles figurant dans ce nouveau catalogue peuvent être reçus avec la marque et la référence JMA ou une autre marque du groupe JMA.

JMA-SCHLÜSSEL KATALOG C.12

Die in diesem Katalog dargestellten Schlüssel sind JMA-Teile, die von Alejandro ALTUNA S.A. oder einem seiner Subunternehmer gefertigt wurden. Sie sind für Schließzylinder und Schlösser der Hersteller ausgelegt, deren Marken in den Katalogen angegeben sind. Gemäß den geltenden gesetzlichen Bestimmungen zum gewerblichen Schutzrecht, sind die in diesem Katalog angegebenen Marken oder Handelsbezeichnungen das ausschließliche Eigentum der Hersteller von Schließzylindern und Schlössern, ebenso der Hersteller von Automobilen, anderen Herstellerfirmen, Vertriebsunternehmen und Benutzern. Diese Marken oder Handelsbezeichnungen sind nur in rein informativer Form angegeben, um schnell die Schlösser finden zu können, zu denen unsere Teile gehören.

Dieser Katalog ist ausschließlich für Fachleute im Bereich der Schlüsselkopie reserviert, die JMA-Teile verwenden. Die Angaben zu den Produkten in diesem Katalog dienen nur als Hinweis. Unter Beibehaltung der Grundeigenschaften behalten wir uns das Recht vor, ohne Vorankündigung, technische, ästhetische oder sonstige Änderungen vorzunehmen, wenn es die Weiterentwicklung der jeweiligen Produkte verlangt. Einige Modelle in unserem neuen Katalog erhalten Sie mit der Marke und Referenz von JMA, oder mit einer anderen Marke der Gruppe ALTUNA.

CHAVES JMA. CATÁLOGO C.12

As chaves que aparecem neste catálogo são peças JMA fabricadas por Alejandro ALTUNA, S.A. ou um subcontratado desta. Estão desenhadas para cilindros e fechaduras dos fabricantes cujas marcas se indicam neste catálogo. Segundo as disposições legais vigentes relativas à propriedade industrial, as marcas ou as designações comerciais indicadas neste catálogo são propriedade exclusiva dos fabricantes de comandos, cilindros e fechaduras, assim como dos fabricantes de automóveis, outros construtores, distribuidores e utilizadores. As referidas marcas ou designações comerciais são indicadas apenas como informação, a fim de reconhecer rapidamente a fechadura a que correspondem as nossas peças.

Este catálogo está reservado exclusivamente a profissionais da reprodução de chaves que utilizam peças JMA. Os dados referentes aos produtos deste catálogo serão entendidos apenas como informação. Mantendo sempre as características básicas, reservamo-nos o direito de realizar, sem aviso prévio, alterações técnicas, estéticas ou outras, por razões de evolução dos referidos produtos. Alguns dos modelos deste novo catálogo estão disponíveis tanto sob a marca e referência JMA como sob outra marca do Grupo ALTUNA.

KLUCZE JMA. KATALOG C.12

Klucze zaprezentowane w niniejszym katalogu stanowią elementy marki JMA wytwarzane przez firmę Alejandro ALTUNA S.A. lub jej podwykonawcę. Zostały zaprojektowane do wkładek i zamków producentów marek, które zostały przedstawione w niniejszym katalogu. Zgodnie z obowiązującymi przepisami dotyczącymi własności przemysłowej marki lub nazwy handlowe wskazane w niniejszym katalogu stanowią wyłączną własność producentów wkładek i zamków, jak również producentów samochodów, innych wytwórców, dystrybutorów i użytkowników. Wspomniane marki lub nazwy handlowe są prezentowane wyłącznie w celach informacyjnych, aby umożliwić szybkie wyszukiwanie zamków, do których pasują elementy oferowane przez firmę.

Niniejszy katalog jest przeznaczony wyłącznie dla specjalistów z branży kopiowania kluczy korzystających z produktów JMA. Dane dotyczące produktów zawartych w niniejszym katalogu mają charakter informacyjny. Przy każdorazowym zapewnieniu podstawowych właściwości produktów firma zastrzega sobie prawo do dokonywania zmian technicznych, estetycznych lub innych bez wcześniejszego powiadomienia, mając na celu rozwój oferowanych produktów. Niektóre modele przedstawione w niniejszym nowym katalogu mogą być dostarczane pod marką i modelem JMA lub pod inną marką Grupy ALTUNA.

Legal warning

Aviso legal
Lege-oharra
Mentions légales
Impressum
Aviso legal
Informacje prawne



KEY IDENTIFICATION BY APPEARANCE

All the keys in this catalogue are 1:1 scale; both the silhouette outline and profile, to facilitate a precise search.

Steps to follow for identifying the key:

1. IDENTIFICATION OF THE SILHOUETTE

2. IDENTIFICATION OF THE PROFILE

Make sure the profile of the catalogue has the same shape and dimension, by placing the physical key over the image in the catalogue.

IDENTIFICACIÓN DE LLAVES POR APARIENCIA

Todas las llaves del catálogo están en escala 1:1; tanto la silueta como el perfil, para hacer una búsqueda más fácil y precisa.

Pasos a seguir para la identificación de la llave:

1. IDENTIFICACIÓN DE LA SILUETA

2. IDENTIFICACIÓN DEL PERFIL

Cerciorar que el perfil del catálogo tiene la misma forma y dimensión, colocando la llave física sobre la imagen del catálogo.

GILTZAK ITXURAREN ARABERA IDENTIFIKATZEA

Katalogoko giltza guztiak 1:1 eskalan agertzen dira; hala silueta nola profila, bilaketa errazagoa eta zehatzagoa izan dadin.

Giltza identifikatzeko urratzak:

1. SILUETA IDENTIFIKATZEA

2. PROFILA IDENTIFIKATZEA

Katalogoko profilak forma eta dimentsio bera duela ziurtatzea, giltza fisikoa katalogoko irudiaren gainean jarritz.

IDENTIFICATION DES CLÉS PAR L'APPARENCE

Toutes les clés du catalogue sont à l'échelle 1:1; aussi bien la silhouette que le profil, afin de permettre une recherche plus simple et précise.

Étapes à suivre pour l'identification de la clé :

1. IDENTIFIER LA SILHOUETTE

2. IDENTIFIER LE PROFIL

S'assurer que le profil du catalogue a la même forme et les mêmes dimensions, en plaçant la clé physique sur l'image du catalogue.

IDENTIFIZIERUNG DER SCHLÜSSEL NACH AUSSEHEN

Alle Schlüssel des Katalogs sind im Maßstab 1:1 dargestellt; sowohl der Umriss als auch das Profil, um die Suche einfacher und präziser für Sie zu machen.

Bei der Identifizierung des Schlüssels einzuhaltende Schritte:

1. IDENTIFIZIERUNG DES UMRISSES

2. PROFILIDENTIFIZIERUNG

Sie finden heraus, ob das Profil im Katalog dieselbe Form und Abmessung hat, indem Sie den physischen Schlüssel auf die Abbildung im Katalog legen.

IDENTIFICAÇÃO DA CHAVE PELA APARÊNCIA

Todas as chaves do catálogo estão à escala 1:1, tanto a silhueta como o perfil, para facilitar a pesquisa e torná-la mais precisa.

Passos a seguir para a identificação da chave:

1. IDENTIFICAÇÃO DA SILHUETA

2. IDENTIFICAÇÃO DO PERFIL

Certifique-se de que o perfil do catálogo tem a mesma forma e dimensão, colocando a chave física na imagem do catálogo.

OKREŚLENIE KLUCZY NA PODSTAWIE ICH CECH ZEWNĘTRZNYCH

Wszystkie klucze przedstawione w katalogu zostały zaprezentowane w skali 1:1 zarówno jeśli chodzi o przekrój klucza, jak i jego profil, w celu ułatwienia dokładniejszego wyszukiwania.

Aby zidentyfikować klucz, należy wykonać następujące czynności:

1. ZIDENTYFIKOWAĆ PRZEKRÓJ KLUCZA

2. ZIDENTYFIKOWAĆ PROFIL KLUCZA

Upewnić się, że profil przedstawiony w katalogu ma identyczny kształt i wymiary, umieszczając fizyczny klucz na rysunku w katalogu.

Manual of use

Manual de uso
Erabilera-eskuliburua
Guide d'utilisation
Gebrauchsanweisung
Manual de Utilização
Instrukcja obsługi



1. IDENTIFICATION OF THE SILHOUETTE

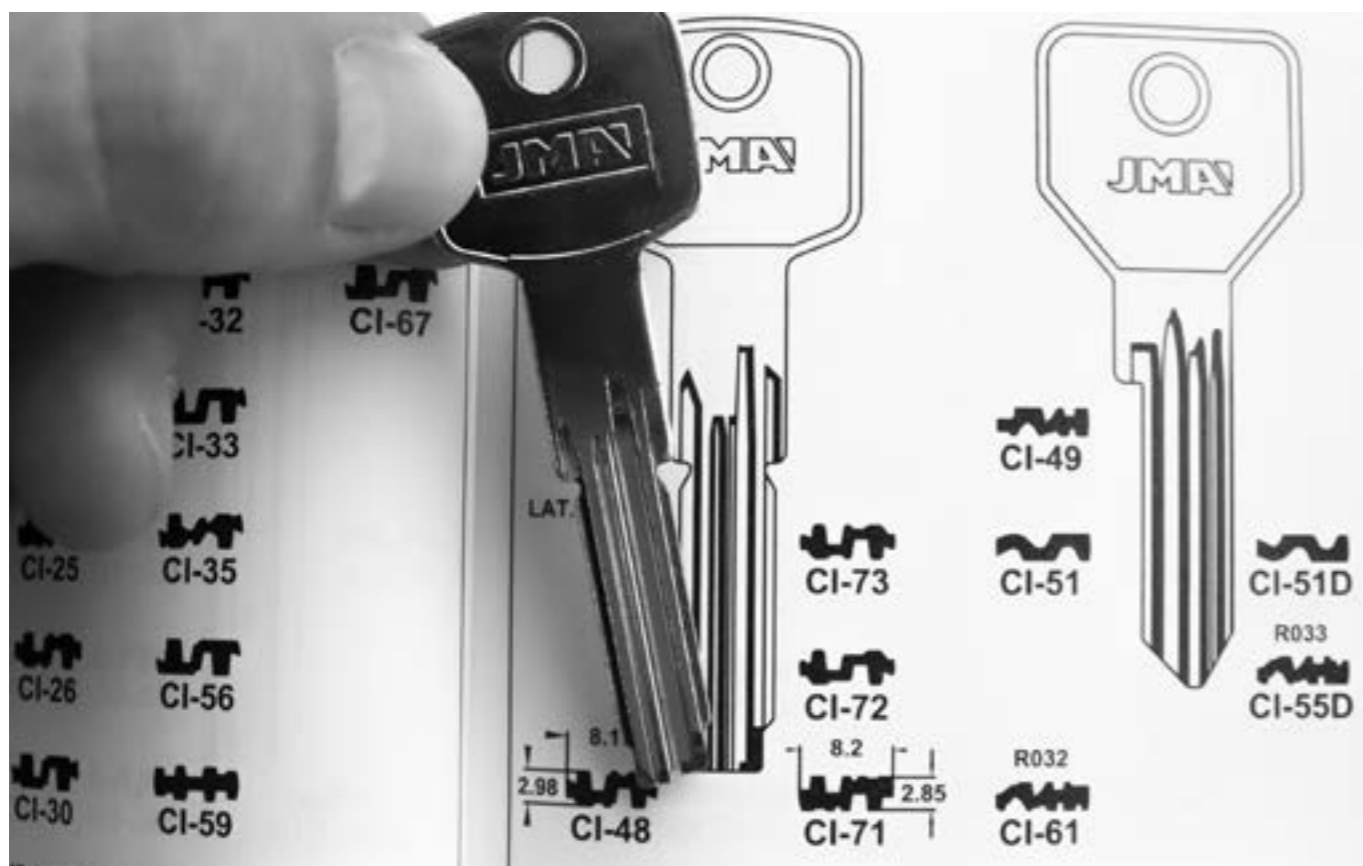

2. IDENTIFICATION OF THE PROFILE

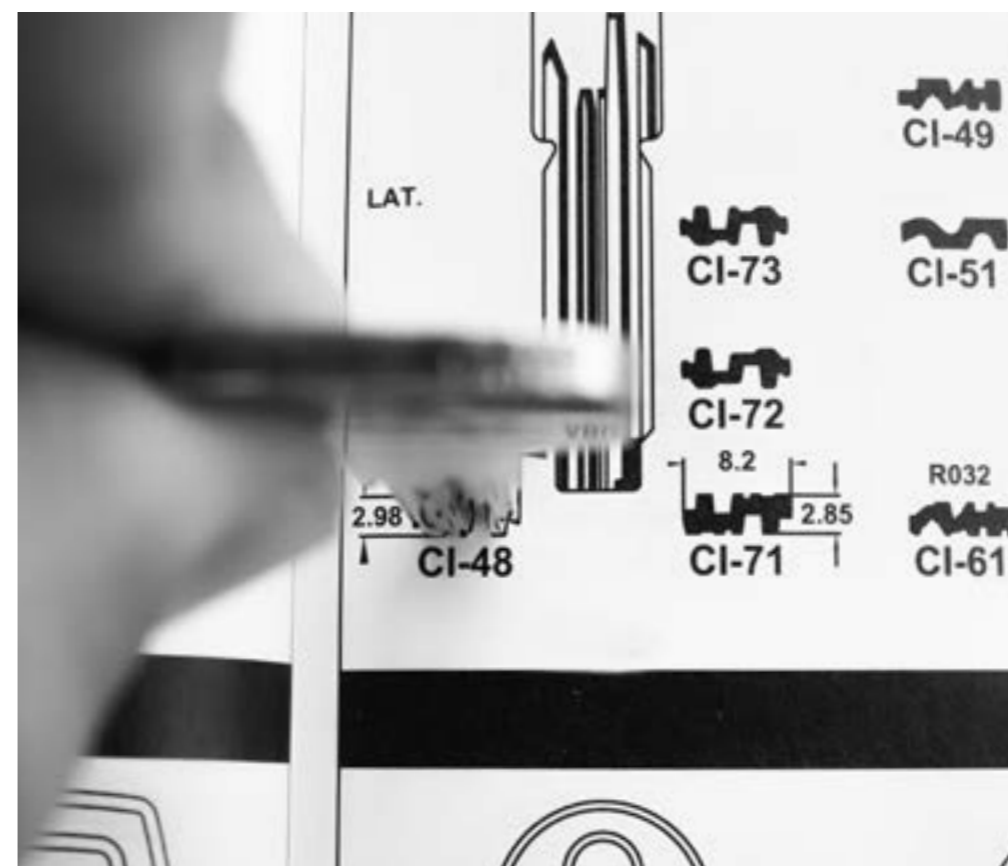

TERMINOLOGY

TERMINOLOGÍA

TERMINOLOGIA

TERMINOLOGIE

1. MAIN BRAND
2. HEAD
3. NECK
4. SHOULDER
5. BLADE
6. TIP
7. USE
8. ORIGINAL PROFILE
9. LEFT PROFILE
10. RIGHT PROFILE
11. REFERENCE
12. SECONDARY BRAND
13. SERIES
14. MAIN BRAND AND NATIONALITY
15. SECONDARY BRANDS OF THE MAIN ONE (ABSA)

1. MARCA PRINCIPAL
2. CABEZA
3. CUELLO
4. TOPE
5. PALETÓN
6. PUNTA
7. UTILIZACIÓN
8. NOMENCLATURA DE PERFIL ORIGINAL
9. PERFIL IZQUIERDO
10. PERFIL DERECHO
11. REFERENCIA
12. MARCAS SECUNDARIAS
13. SERIES
14. MARCA PRINCIPAL
15. MARCAS SECUNDARIAS DE LA PRINCIPAL (ABSA)

1. MARKA NAGUSIA
2. BURUA
3. LEPOA
4. TOPEA
5. BELARRIA
6. PUNTA
7. ERABILERA
8. JATORRIZKO PROFILAREN IZENDEGIA
9. EZKERREKO PROFILA
10. ESKUINEKO PROFILA
11. ERREFERENTZIA
12. BIGARREN MAILAKO MARKAK
13. SERIEAK
14. MARCA NAGUSIA ETA JATORRIZKOA
15. MARKA NAGUSIAREN BIGARREN MAILAKO MARKAK (ABSA)

1. MARQUE PRINCIPALE
2. TÊTE
3. COU
4. ARRÊT
5. CANON
6. POINTE
7. UTILISATION
8. PROFIL ORIGINAL
9. PROFIL GAUCHE
10. PROFIL DROIT
11. RÉFÉRENCE MARQUE
12. SECONDAIRE
13. CODE
14. MARQUE PRINCIPALE ET NATIONALITÉ
15. MARQUES SECONDAIRES DE LA PRINCIPALE (ABSA)

TERMINOLOGIE

TERMINOLOGIA

OBJAŚNIENIE TERMINÓW

1. HAUPTPRÄGUNG
2. KOPF
3. HALS
4. ANSCHLAG
5. SCHAFT
6. SPITZE
7. VERWENDUNG
8. ORIGINALPROFIL
9. LINKSPROFIL
10. RECHTSPROFIL
11. BEZEICHNUNG
12. 2. PRÄGUNG
13. SERIE
14. HAUPTPRÄGUNG UND NATIONALITÄT
15. 2. PRÄGUNG FÜR HAUPTPRÄGUNG (ABSA)

1. MARCA PRINCIPAL
2. CABEÇA
3. GOLA
4. BATENTE
5. PALHETÃO
6. PONTA
7. UTILIZAÇÃO
8. NOMENCLATURA DO PERFIL ORIGINAL
9. PERFIL ESQUERDO
10. PERFIL DIREITO
11. REFERÊNCIA
12. MARCAS SECUNDÁRIAS
13. SÉRIES
14. MARCA PRINCIPAL
15. MARCAS SECUNDÁRIAS DA PRINCIPAL (ABSA)

1. MARKA GŁÓWNA
2. GŁÓWKA
3. SZYJKA
4. ZDERZAK
5. GROT
6. CZUBEK
7. PRZEZNACZENIE
8. NAZEWNICTWO PROFILU ORYGINALNEGO
9. PROFIL LEWY
10. PROFIL PRAWY
11. SYMBOL
12. MARKI DRUGORZĘDNE
13. SERIE
14. MARKA GŁÓWNA
15. MARKI DRUGORZĘDNE WOBEC MARKI GŁÓWNEJ (ABSA)

Description

- Descripción
- Deskribapena
- Description
- Beschreibung
- Descrição
- Opis

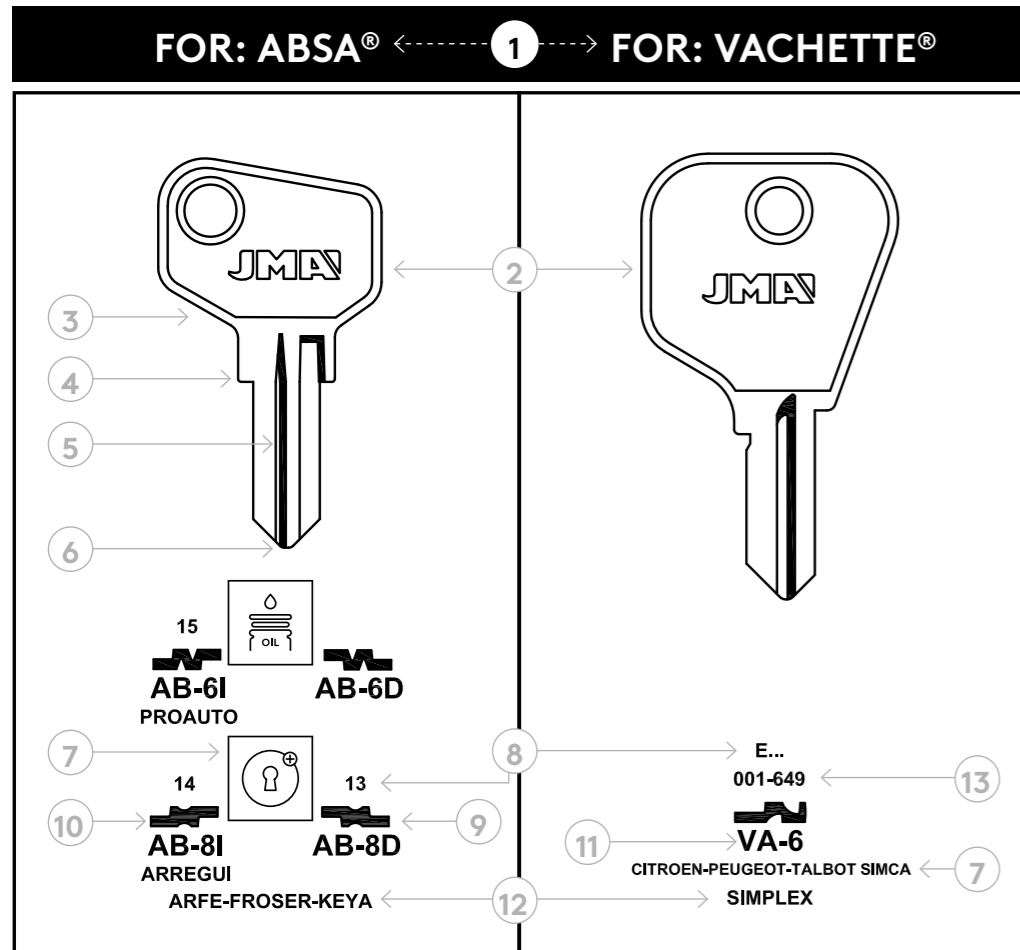
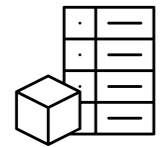

TERMINOLOGY

1. HEAD
2. NECK
3. SHANK
4. DIAMETER
5. SHANK
6. LENGTH A
7. BIT PIN BIT PROFILE
8. REFERENCE
9. ORIGINAL BRAND
10. PIPE BIT PROFILE

TERMINOLOGÍA

1. CABEZA
2. CUELLO
3. DIÁMETRO DE LA CAÑA
4. CAÑA
5. LONGITUD A
6. PALETON
7. PERFIL MACHO
8. REFERENCIA
9. MARCA ORIGINAL
10. PERFIL HEMBRA

TERMINOLOGIA

1. BURUA
2. LEPOA
3. ZIRIAREN DIAMETROA
4. ZIRIA
5. A LUZERA
6. BELARRIA
7. PROFIL ARRA
8. ERREFERENTZIA
9. JATORRIZKO MARKA
10. PROFIL EMEA

TERMINOLOGIE

1. TÊTE
2. COU
3. DIAMETRE DU CANON
4. CANON
5. LONGUEUR A
6. PANNETON
7. PROFIL MALE
8. RÉFÉRENCE
9. MARQUE ORIGINALE
10. PROFIL FEMELLE

TERMINOLOGIE

1. KOPF
2. HALS
3. HALM-DURCHMESSER
4. HALM
5. LÄNGE A
6. BART
7. SCHWEIFUNG
8. BEZEICHNUNG
9. ORIGINAL-PRÄGUNG
10. GEBOHRT

TERMINOLOGIA

1. CABEÇA
2. GOLA
3. DIÂMETRO DA CANA
4. CANA
5. COMPRIMENTO A
6. PALHETÃO
7. PERFIL MACHO
8. REFERÊNCIA
9. MARCA ORIGINAL
10. PERFIL FÊMEA

OBJAŚNIENIE TERMINÓW

1. GŁÓWKA
2. KOŁNIERZ
3. ŚREDNICA RURKI
4. RURKA
5. DŁUGOŚĆ A
6. PŁETWA
7. PROFIL
8. SYMBOL
9. MARKA ORYGINALNA
10. PROFIL

Description

- Descripción
- Deskripción
- Description
- Beschreibung
- Descrição
- Opis

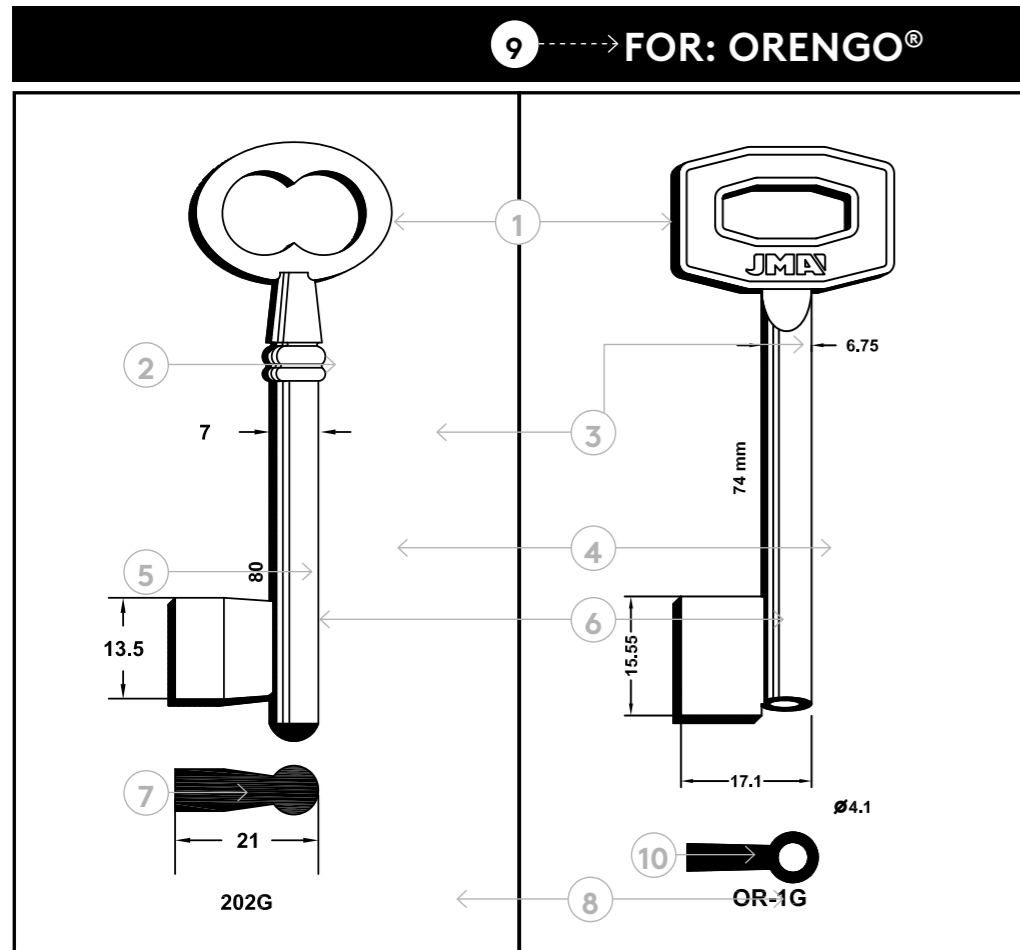
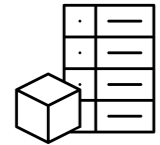

COUNTRY CODES

Códigos por país
 Herrialde-kodeak
 Codes pays
 Ländercodes
 Códigos por país
 Kody wg kraju

🇦🇹	AUSTRIA
🇦🇺	AUSTRALIA
🇧🇪	BELGIUM
🇧🇷	BRAZIL
🇨🇩	CANADA
🇨🇭	SWITZERLAND
🇩🇪	GERMANY
🇩🇰	DENMARK
🇩🇿	ALGERIA
🇪🇸	SPAIN
🇪🇸	ESLOVAKIA
🇪🇬	EGYPT
🇫🇷	FRANCE
🇬🇧	GREAT BRITAIN
🇬🇷	GREECE
🇭🇺	HUNGARY
🇭🇰	HONG KONG
🇭🇷	CROATIA
🇮🇹	ITALY
🇮🇱	ISRAEL
🇮🇳	INDIA
🇮🇷	EIRE
🇯🇵	JAPAN
🇰🇷	KOREA
🇰🇼	KUWAIT
🇲🇽	MEXICO
🇳🇴	NORWAY
🇳🇱	THE NETHERLANDS
🇵🇹	PORTUGAL
🇵🇪	PERU
🇵🇱	POLAND
🇷🇦	ARGENTINA
🇷🇨	TAIWAN
🇷🇨	CHILE
🇷🇨	CHEKIA
🇷🇺	RUMANIA
🇸🇪	SWEDEN
🇸🇫	FINLAND
🇸🇯	SLOVENIA
🇷🇺	RUSIA
🇨🇳	CHINA
🇹🇳	TUNISIA
🇺🇸	UNITED STATES OF AMERICA
🇾🇺	YUGOSLAVIA
🇻🇪	VENEZUELA
🇿🇲	ZAMBIA

MATERIAL ABBREVIATIONS

Abreviaturas materiales
 Laburdura materialak
 Abréviations matérielles
 Materielle Abkürzungen
 Abreviaturas dos materiais
 Skróty materiałowe

ALP.

Key available in nickel silver
 Llave fabricada en alpaca
 Alpakaz egindako giltza
 Clé fabriquée en maillechort
 Schlüssel auch in Neusilber lieferbar
 Chave também disponível em níquel-prata
 Klucze z mosiądzu wysokoniklowego

LAT.

Key also available in brass
 Llave disponible también en latón
 Giltza, letoizkoa ere eskuragarria
 Clé aussi disponible en laiton
 Schlüssel auch in Messing lieferbar
 Chave também disponível em latão
 Klucz dostępny również w wykonaniu mosiężnym

COL.

Available with coloured plastic head
 Disponible con cabeza de plástico en colores
 Koloretako plastikozko buruarekin eskuragarri
 Disponible avec tête plastifiée en couleurs
 Erhältlich mit farbigem Kunststoffkopf
 Disponível com cabeça de plástico às cores
 Dostępny z kolorową główką z tworzywa sztucznego

ALU.

Key also available in aluminium
 Llave disponible también en aluminio
 Giltza, aluminioan ere eskuragarria
 Clé aussi disponible en aluminium
 Schlüssel auch in Aluminium lieferbar
 Chave também disponível em alumínio
 Klucz dostępny również w wykonaniu aluminiowym

ZAM.







Key only available in zamak
 Llave fabricada solamente en zamak
 Zamakez soilik egindako giltza
 Clé aussi disponible en zamak
 Schlüssel nur aus Zamak lieferbar
 Chave fabricada apenas em zamak
 Klucz produkowany wyłącznie ze znu

PLAS.

Key also available in plastic
 Llave disponible también en plástico
 Giltza, plastikoa ere eskuragarria
 Clé aussi disponible en plastique
 Schlüssel auch in plastik lieferbar
 Chave também disponível em plástico
 Klucz dostępny również w wykonaniu plastikowym

CONVENTIONAL SIGNS

Signos convencionales
 Zeinu konbentzionalak
 Signes conventionnels
 Herkömmliche Zeichen
 Sinais convencionais
 Znaki konwencjonalne

	Key for padlocks Llave para candados Giltzarrapoetan erabiltzeko giltzak Clé pour cadenas Schlüssel für Hangschlösser Chave para cadeados Klucz do klódek
	Key for cam locks Llave para cerradura auxiliar Sarraila osagarrirako giltza Clé pour petite serrurie Schlüssel für Hebelschlösser Chave para fechadura auxiliar Dodatkowy klucz do zamka
	Key for motorcycles Llaves para motocicletas Motozikleta giltzak Clé pour motocyclettes Schlüssel für Motorräder Chaves para motocicletas Kluczyki do motocykli
	Key for fuel cap Llave para tapón de gasolina Gasolina-tapoietarako giltza Clé pour bouchon d'essence Schlüssel für Tankdeckel Chave para tampão do depósito da gasolina Klucz do wlewu paliwa
	Key for lorries Llave para camión Kamioiko giltza Clé pour camion Schlüssel für Lastkraftwagen Chave para camião Kluczyk do pojazdu ciężarowego
	Alarm Alarma Alarma Alarme Alarm Alarme Alarm
	Bit key blank natural finishing Llave gorja acabado natural Akabera naturaleko gorja giltzak Clé à gorges finition naturel Chubbschlüssel in naturfarben Ausführung Chave gorja acabamentoo natural Klucz zasuwowy w wykończeniu naturalnym
	Bit key blank with old black finishing Llave gorja acabado negro antiguo Beltz zaharkitu akabera gorja giltza Clé à gorges finition noir Chubbschlüssel in altschwarzer Ausführung Chave gorja acabamentoo preto envelhecido Klucz zasuwowy w wykończeniu antycznej czerni

DESCRIPTIVE SYMBOLOGY

Simbología descriptiva
 Zeinu konbentzionalak
 Signes conventionnels
 Herkömmliche Zeichen
 Simbologia descritiva
 Symbole opisowe

	Calendar Calendario Egutegia Calendrier Kalender Calendário Kalendarz
	Engine ignition Contacto auto Autoko kontaktua Contact auto Zündschloss Pkw Contacto auto Stacyjka samochodu
	Door lock Puerta auto Autoko atea Portière Türe Porta auto Drzwi samochodu
	Boot/ Hatchback Maletero / Puerta trasera Maletategia / Atzeko atea Coffre / Haillon Kofferraum / Hecktür Porta-bagagens / Porta traseira Bagażnik / tylne drzwi
	Petrol cap Tapón de gasolina Gasolina-tapoa Bouchon réservoir Benzintankverschluss Tampão do depósito da gasolina Wlew paliwa
	Drawer Guantero Eskularru-kutxa Tiroir Schublade Porta-luvas Schowek
	Motorbike ignition Contacto moto Moto-kontaktua Contact moto Zündschloss Motorrad Contacto moto Stacyjka motocyklu
	Motorbike disc lock Bloqueo moto Moto-blokea Bloquage moto Bremsenschloss Motorrad Bloqueio moto Blokada motocyklu
	Cycle seat Sillín Zela Selle Sattel Selim Siodefko
	Helmet Casco Kaskoa Casque Helm Capacete Kask
	Car / Pick-up trucks Automovil / Camioneta Automobila / Kamioneta Voiture / Camionnette Auto / Kleintransporter Automóvel / Camioneta Samochód / furgonetka
	Motorcycle Motocicleta Motozikleta Motocyclette Motorrad Motocicleta Motocykl
	Truck Camión Kamioia Camion Lkw Camião Pojazd ciężarowy
	Aeroplane Avión Hegazkia Avion Flugzeuge Avião Samolot
	Caravan Caravana Karabana Caravane Wohnwagen Caravana Samochód kempingowy
	Boat engines Motor marino Itsas motorra Moteur de bateau Schiffsmotoren Motor náutico Silnik do statków
	Bicycle Bicicleta Bizikleta Bicyclette Fahrräder Bicicleta Rower
	Ski holder Portaesquis Eski-euskarria Porte ski Skiträger Porta-esquis Uchwyt na narty
	Tractor Tractor Traktorea Tracteur Landmaschinen Trator Ciągnik
	Earth moving machine Escavadora Hondeatzailea Excavatrice Baumaschinen Escavadora Koparka
	Forklift Carretilla elevadora Orga jasotzailea Chariot élévateur Gabelstapler Empilhador Wózek widłowy
	Lawn-mower Corta césped Belarra mozteko makina Tondeuse Rasenmäher Cortador de relva Kosiarka

Symbol and codes

Símbolos y códigos
 Sinboloak eta kodeak
 Symboles et codes
 Symbole und codes
 Símbolos y códigos
 Symbole i Kody

Guide

BENCHMARK INDEX

Índice de referencias
Erreferentzia aurkibidea
Index des références
Referenzverzeichnis
Índice de referências
Spis modeli

Índice de referencias
Erreferentzia aurkibidea
Index des références

Referenzverzeichnis
Índice de referências
Spis modeli

REF.	PAG.	REF.	PAG.	REF.	PAG.	REF.	PAG.	REF.	PAG.	REF.	PAG.	REF.	PAG.	REF.	PAG.	REF.	PAG.
1G	398	203G	384	620G	389	1626G	397	ABL-6	2	ABU-32D	5	ABU-72P	6	AD-24	400	AF-7D	156, 165, 167, 179,
2G	398	204G	384	622G	390	A-0G	456	ABU-1	3	ABU-34	124	ABU-72P	346	AD-25	400		156, 165, 167, 179,
3G	398	205G	384	623G	390	A-0G(CV)	456	ABU-1D	3	ABU-35DP	150	ABU-73D	6	AD-26	400		184, 185, 188, 192,
3M-1D	2	206G	384	624G	390	A-1G	456	ABU-2D	3	ABU-35DP	5	ABU-74	3	AD-27	400		219, 227, 228,
4G	398	207G	384	625G	390	A-1G(CV)	456	ABU-2G	443	ABU-35DP	346	ABU-74D	3	AD-28	400		233, 246, 256,
5G	398	208G	385	626G	390	A-1G-1	456	ABU-2I	3	ABU-35P	150	ABU-75D	6	AD-29	400		267, 271, 299, 317,
5-L	104	209G	385	716-1G	402	A-1G-2	456	ABU-3	3, 346	ABU-35P	5	ABU-76	3	AD-30	400		319, 325, 336,
6-C	112	210G	385	716-2G	402	A-1G-3	456	ABU-4D	3	ABU-36P	5	ABU-77	5	AD-33T	442		338
6G	398	213G	385	1200G	391	A-1G-4	456	ABU-4I	3	ABU-36P	150	ABU-78	6	AD-44-1	400		299, 317, 320,
6-L	112	214G	385	1201G	391	A-1G-5	456	ABU-5D	3	ABU-36P	5	ABU-79	6	AD-44-2	400		325, 336, 338
7G	398	216G	385	1202G	391	A-1G-6	456	ABU-6D	3	ABU-36P	346	ABU-80	5	AD-44-3	400		299, 317, 320,
7-S	91	217G	386	1203G	391	A-2G	456	ABU-6I	3	ABU-37D	3	ABU-81	124	AD-44-4	400		325, 336, 338
7-S	460	219G	386	1204G	391	A-2G(CV)	456	ABU-7D	3	ABU-38D	5	ABU-83	5	AD-44-5	400		156, 165, 167, 179,
8G	398	221G	386	1205G	391	A-2G-1	456	ABU-8D	3	ABU-39P	5	ABU-84D	6	AD-44-6	400		184, 185, 188, 192,
8M-1D	81	223G	386	1206G	391	A-3G	456	ABU-8I	3	ABU-40	5	ABU-85	5	AD-47	446		219, 227, 228,
11G	398	224G	386	1207G	391	A-3G(CV)	456	ABU-9D	3	ABU-40	346	ABU-86D	6	ADPLE-11	401		233, 246, 256,
12G	398	225G	386	1208G	392	A-4G	456	ABU-9I	3	ABU-41	5	ABU-87P	6	ADPLE-22	401		267, 271, 296,
13G	399	226G	386	1209G	392	A-5G	456	ABU-10D	3	ABU-41D	5	ABU-87P	346	ADPLE-33	401		299, 310, 317,
	399	228G	386	1210G	392	AA-1G	456	ABU-10I	3	ABU-42	5	ABU-88P	6	ADPLE-44	401		233, 246, 256,
15-D	185	229G	386	1211G	392	AA-1G(CV)	456	ABU-11	4	ABU-42	346	ABU-88P	346	ADS-1D	7		268, 271, 296,
15G	399	231G	386	1212G	392	AA-2G	456	ABU-11D	4	ABU-42D	5	ABU-89D	6	AEP-1D	7		299, 310, 317,
15-I	185	232G	387	1213G	392	AA-2G(CV)	456	ABU-12D	3	ABU-42D	346	ABU-90	6	AEP-2D	7		320, 325, 336,
16G	399	233G	387	1214G	393	AA-3G	457	ABU-12I	3	ABU-43D	3	ABU-91	124	AF-2D	156, 156, 165, 185		338
17G	399	234G	387	1215G	393	AA-3G(CV)	457	ABU-13	4	ABU-44	3	ABU-92	5	AF-2I	156, 156, 165, 185		338
19G	399	236G	387	1216G	393	AB-1D	3	ABU-13	346	ABU-45	5	ABU-92D	5	AF-3D	156		156, 165, 167, 179,
21G	399	237G	387	1217G	393	AB-1I	3	ABU-13D	4	ABU-45	346	ABU-93	6	AF-3I	156		184, 185, 188, 192,
23G	399	238G	387	1218G	393	AB-1T	146	ABU-13D	346	ABU-46	3	ABU-94D	6	AF-4D	185, 227, 246, 256		219, 227, 228,
24G	399	239G	387	1219G	393	AB-2D	3	ABU-14	3	ABU-46D	3	ABU-96	124	AF-4I	185, 227, 246,		233, 246, 256,
25G	399	303-1	2	1220G	393	AB-2I	3	ABU-15	3	ABU-47	3	ABU-99D/1	5		267, 271, 296,		267, 271, 296,
26-M	86, 46	303-1D	2	1221G	393	AB-2T	146	ABU-15D	3	ABU-48	5	ABU-99D/2	5	AF-5D	150, 156, 165, 179		299, 310, 317, 319,
35-D	112	333-1D	2	1241G	393	AB-3I	3	ABU-16	124	ABU-49	3	ABU-99D/3	5		325, 336, 338		325, 336, 338
35-I	112	333-2D	2	1242G	394	AB-3T	146	ABU-17	6	ABU-50	5	ABU-100	5	AF-8D	156, 165, 167, 179,		184, 185, 188, 192,
38-D	112	500	300	1243G	394	AB-4T	146	ABU-17D	6	ABU-51D	5	ABU-101P	6		184, 185, 188, 192,		219, 228, 228,
38-I	112	501	300	1244G	394	AB-5D	3, 172	ABU-18DP	4	ABU-52D	3	ABU-102	124	AF-8DP	156, 165, 168, 179,		246, 256, 267,
45-1	2	502	300	1245G	394	AB-5I	3, 172	ABU-18DP	346	ABU-53	3	ABU-103DP	6		184, 185, 188, 192,		282, 299, 318,
45-1D	2	503	300	1246G	394	AB-6D	3, 150, 193,	ABU-18P	4	ABU-54	5	ABU-103DP	346	AF-19	151, 159, 166, 183,		324, 325, 326,
45-2	2	504	300	1247G	394		230, 274	ABU-18P	346	ABU-54D	5	ABU-104DP	7		184, 187, 189, 190,		299, 310, 317,
45-2D	2	505	300	1248G	394	AB-6I	3, 150, 193, 2	ABU-19D	150	ABU-55	3	ABU-104DP	346	AF-5I	150, 156, 165, 179,		320, 325, 336,
51G	441	506	300	1250G	394		30, 274	ABU-19D	4	ABU-55D	3	AC-9	460		338, 341		338
52G	441	507	300	1252G	395	AB-8D	3, 150, 193,	ABU-19D	346	ABU-57	5	AC-12	460	AF-8I	156, 165, 167, 179,		184, 185, 188, 192,
52GPC	441	508	300	1254G	395		230, 274	ABU-19DP	150	ABU-57D	5	AC-14	460		156, 165, 167, 179,		184, 185, 188, 192,
53G	441	509	300	1255G	395	AB-8I	3, 150, 193, 2	ABU-19DP	4	ABU-58D	5	AC-15	460	AF-19P	296, 301, 310,		219, 227, 228,
54G	441	510	300	1256G	395		30, 274	ABU-19DP	346	ABU-60	5	AD-1	400		233, 246, 256,		267, 282, 299,
55G	442	512	300	1600G	395	AB-9D	3	ABU-19P	150	ABU-61	124	AD-2	400	AF-21	151, 159, 166, 183,		318, 324, 325,
56G	442	513	300	1602G	395	AB-10I	172	ABU-19P	4	ABU-63	124	AD-3	400		184, 187, 189, 190,		327, 332, 335,
57G	442	600G	388	1603G	395	AB-1I	3	ABU-19P	346	ABU-64P	150	AD-4	400	AF-6D	150, 156, 165, 179,		338, 341
66G	442	601G	388	1604G	395	ABA-1	2	ABU-20	3	ABU-64P	5	AD-5	400		184, 185, 188,		184, 185, 188,
68G	442	602G	388	1605G	395	ABC-1	2	ABU-21	4	ABU-64P	346	AD-6	400		179, 184, 185, 188,		192, 218, 227,
72G	442	603G	388	1606G	396	ABC-2	2	ABU-21	346	ABU-65P	150	AD-7	400	AF-8IP	156, 165, 168,		192, 219, 228,
73G	442	605G	388	1607G	396	ABC-3D	2	ABU-22D	4	ABU-65P	5	AD-8	400		179, 184, 185, 188,		233, 246, 256,
74G	391	607G	388	1610G	396	ABC-5D	2	ABU-23D	4	ABU-65P	346	AD-9	400		228, 233, 246,		256, 268, 271,
101-1G	402	608G	388	1611G	396	ABC-5I	2	ABU-24D	4	ABU-66	124	AD-10	400	AF-21P	151, 159, 166,		267, 282, 299,
101-2G	402	609G	388	1613G	396	ABC-6	124	ABU-25D	4	ABU-67	3	AD-11	400		184, 187, 189, 190,		318, 324, 325,
101G	446	610G	389	1615G	396	ABC-7	124	ABU-26D	4	ABU-67D	3	AD-12	400		190, 191, 193, 226,		327, 332, 335,
126H-60G	402	611G	389	1616G	396	ABL-1	2	ABU-27	4	ABU-68	5	AD-13	400	AF-6I	150, 156, 165, 179,		338, 341
126N-60G	402	612G	389	1617G	397	ABL-2	2	ABU-27D	4	ABU-69	3	AD-16	400		184, 185, 188, 192,		338, 341
126PP-60G	402	614G	389	1619G	397	ABL-3	2	ABU-28	4	ABU-70	5	AD-18	400		179, 184, 185,		246, 256, 267,
200G	384	615G	389	1622G	397	ABL-3D	2	ABU-29P	4	ABU-70D	5	AD-19	400		188, 192, 219,		227, 228, 233,
201G	384	616G	389	1625G	397	ABL-4	2	ABU-30	4	ABU-71D	3	AD-21	400		246, 256, 267,		282, 299, 318,
202G	384	618G	389			ABL-5	3	ABU-30D	4			AD-23	400		324, 325, 327,		324, 325, 327,

Índice de referencias
Erreferentzia aurkibidea
Index des références

Referenzverzeichnis
Índice de referências
Spis modeli

REF.	PAG.	REF.	PAG.	REF.	PAG.	REF.	PAG.	REF.	PAG.	REF.	PAG.	REF.	PAG.	REF.	PAG.	REF.	PAG.	REF.	PAG.	REF.	PAG.
AG-4I	8	AGA-35G	452	ALF-10D	9	AMM-1	305	ARFE-1D	11	AS-A5	13	AS-LG7	14	ATA-1	10	AZ-17D	15	BAS-1D	159, 203, 204,		
AG-5D	8	AGA-38	124	ALF-11D	9	AMM-1	314	ARFE-1I	11	AS-A7	13	AS-M5	13	ATA-1D	10	AZ-18	15	BAS-1D	205, 207, 208,		
AG-5I	8	AGA-39	124	ALF-12D	9	AMM-2	159, 224	ARFE-3D	11	AS-AK5	13	AS-M7	13	ATL-1	14	AZ-18D	15	BAS-1I	209, 210, 212		
AG-6D	8	AGA-40G	452	ALF-13D	9	AMM-2	314	ARN-1	11	AS-AK7	13	AS-MA7	14	ATR-1G	413	AZ-29	126	BAS-1I	159, 203, 204,		
AG-6I	8	AGA-42	124	ALF-14D	9	ANA-1	11	ARN-2	11	AS-AL5	13	AS-MD7	14	ATR-2G	413	AZ-32	126	BAS-1I	205, 207, 208,		
AG-8D	8	AGA-43	124	ALF-15	9	ANA-1D	11	ARN-2D	11	AS-AL7	13	AS-ME5	14	ATR-2TG	413	AZ-37	15	BAS-1I	209, 210, 212		
AG-8I	8	AGA-44	124	ALF-16	9	ANC-1D	10	ARN-3	11	AS-AM5	13	AS-ME7	14	AU-1	163, 284, 288,	AZ-37D	15	BAS-2D	150, 17		
AG-9D	8	AGA-46G	453	ALF-17	9	ANC-2	10	ARN-3D	11	AS-AM7	13	AS-MF7	14	AU-AH	155, 163, 255, 268,	AZ-37D	15	BAS-2I	150, 17		
AG-9I	8	AGA-48	124	ALF-18	9	ANK-1	10	ARO-1D	11	AS-B5	13	AS-MG5	14	AU-AHP	155, 163, 255, 268,	AZ-37D	15	BAS-2I	150, 17		
AG-10D	8	AGA-48G	453	ALF-19	9	ANK-2	10	ARR-1	12	AS-B7	13	AS-MG7	14	AU-AHP1	163	AZ-39	126	BAS-3	150, 17		
AG-10I	8	AGA-49	124	ALF-20	9	ANK-3	11	ARR-2	12	AS-BK5	13	AS-MM5	13	AU-AN	163, 164, 197, 255,	AZ-40	126	BAS-4	306, 351		
AG-11	8	AGA-49G	453	ALF-21	9	ANK-4	11	ARR-3	12	AS-BK7	13	AS-MM7	13	AU-ANP	163, 164, 197, 255,	AZKO-1I	15	BAST-1I	17		
AG-11D	8	AGA-50	124	ALF-22D	9	ANK-6	11	ARR-7D	12	AS-BL7	13	AS-N5	13	AU-ANP	269, 284, 289,	B-3G	457	BAST-2D	17		
AGA-1G	402	AGA-50G	453	ALF-23	9	ANK-17	11	ARR-8	12	AS-BM7	13	AS-N7	13	AU-ANP	290, 298, 301,	B-3G(CV)	457	BAST-3D	17		
AGA-1I	7	AGA-51	8	ALF-24	9	ANK-47D	11	ARR-9D	12	AS-D7	13	AS-NN5	13	AU-ANP	310, 313, 314	BAB-1I	15	BAST-4DP	17		
AGA-1T	146	AGA-52	8	ALF-25	9	ANK-65	11	ARS-1D	12	AS-DD7	13	AS-NN7	13	AU-ANP	163, 164, 197, 256,	BAB-2I	15	BAT-1D	126		
AGA-1T	146	AGA-55D	124	ALF-26	9	ANT-1G	412	AS-1	267, 291	AS-DK5	13	AS-P5	13	AU-ANP	269, 284, 289,	BAB-2I	15	BATU-1I	17		
AGA-2G	443	AGA-57	8	ALF-27	9	ANT-2G	412	AS-1D	267, 291	AS-DK7	13	AS-P7	13	AU-ANP	290, 298, 301,	BAB-3	15	BCZ-1	16		
AGA-2T	146	AGB-1	8	ALF-28	9	ANT-3G	412	AS-1G	402	AS-DL5	13	AS-PA7	14	AU-ANP	310, 313, 314	BAB-3D	15	BCZ-2	16		
AGA-2T	146	AGB-1D	8	ALF-29	9	ANT-4G	412	AS-2D	318, 346	AS-DL7	13	AS-PB7	14	AU-C	163	BAB-4D	16	BD-1	15		
AGA-3G	443	AGB-2	125	ALF-30	9	ANT-5G	413	AS-2G	402	AS-DM5	13	AS-PF7	14	AU-C	163	BAB-5D	16	BDA-1	126		
AGA-3I	7	AGB-3	8	ALF-31	9	AP-1D	125	AS-2I	318, 346	AS-DM7	13	AS-PG7	14	AU-HV	163, 268, 284,	BAB-5D	16	BE-1	17		
AGA-4D	7	AGB-3D	8	ALF-32D	9	AP-2D	11	AS-3D	12	AS-E5	13	AS-PH7	14	AU-HV	288, 289, 299,	BAB-6	16	BE-1G	413		
AGA-4G	446	AGB-4	125	ALF-33	9	AP-3D	125	AS-3G	402	AS-E7	13	AS-PN7	14	AU-HVP	163, 268, 284,	BAB-7	16	BE-3G	413		
AGA-4I	7	AGB-5	125	ALF-34	9	AP-4D	125	AS-3I	12	AS-EK5	13	AS-PP7	13	AU-HVP	288, 289, 299,	BAB-8D	16	BE-4D	17		
AGA-5D	7	AGB-6	125	ALF-35	9	AP-5D	125	AS-4D	12	AS-EK7	13	AS-PR7	14	AU-HVP1	163	BAB-9D	16	BE-4G	413		
AGA-5G	443	AGB-7	125	ALF-36	9	AP-6D	125	AS-4G	413	AS-EL5	13	AS-PT7	14	AU-HVP1	163	BAB-11	15	BE-4I	17		
AGA-5I	7	AGD-1	8	ALI-1	30	APEC-1G	447	AS-5D	12	AS-EL7	13	AS-R7	13	AU-W	164, 284, 288	BAB-12D	15	BE-5D	17		
AGA-6D	7	AGD-1X	302	ALP-1	9	APEC-2G	447	AS-5G	444	AS-EM5	13	AS-RA7	13	AV-1	14	BAB-13/1	15	BE-5G	414		
AGA-6G	446	AGD-2	8	ALP-1D	9	AR-1D	12	AS-6D	12	AS-EM7	13	AS-RB7	13	AV-1D	14	BAB-13/10	15	BE-5I	17		
AGA-6I	7	AGD-2X	302	ALP-2	9	AR-4DP	12	AS-6G-1	403	AS-F5	13	AS-RC7	13	AV-2D	14	BAB-13/11	15	BE-6G	414		
AGA-7	7	AGE-1I	8	ALP-3	9	AR-4IP	12	AS-6G-2	403	AS-F7	13	AS-RD7	13	AX-1	14, 347	BAB-13/12	15	BE-7G	414		
AGA-7G	447	AGE-2D	8	ALP-4D	9	ARC-1G	443	AS-7D	12	AS-FK5	13	AS-RE7	13	AX-1D	14, 347	BAB-13/13	15	BE-10G	414		
AGA-8D	7	AGU-1D	9	ALP-5D	10	ARC-2G	443	AS-8D	12	AS-FK7	13	AS-RF7	13	AX-1DP	14, 347	BAB-13/2	15	BES-1D	17		
AGA-8G	447	AHR-2	125	ALP-6	9	ARC-3G	443	AS-9D	12	AS-FL7	13	AS-RG7	13	AX-1P	14, 347	BAB-13/3	15	BES-2D	17		
AGA-9G	447	AHR-3	125	ALP-6D	9	ARC-4G	443	AS-10D	12	AS-FM7	13	AS-RH7	13	AX-2P	126, 347	BAB-13/4	15	BES-3D	17		
AGA-9I	7	AIZ-1	9	AMA-1	10	ARC-5G	443	AS-11D	12	AS-G5	13	AS-RK7	13	AX-2P1	126	BAB-13/5	15	BES-4D	17		
AGA-10	7	AIZ-2D	9	AMA-1D	10	ARC-6G	443	AS-12D	12	AS-G7	13	AS-RN7	13	AX-3DP	14, 347	BAB-13/6	15	BES-5D	17		
AGA-11	7	AKA-1PG	412	AMB-1	2	ARC-7G	443	AS-13D	12	AS-GG7	13	AS-RR7	13	AX-4DP	14, 347	BAB-13/7	15	BES-6D	17		
AGA-12	124	AKS-1	291	AMB-1D	2	ARC-8G	443	AS-14D	12	AS-GK5	13	AS-S7	13	AX-5DP1	126	BAB-13/8	15	BES-7D	17		
AGA-13I	7	AKS-1	313	AME-1	10	ARC-10G	443	AS-15D	12	AS-GK7	13	AS-SS7	13	AX-6	126	BAB-13/9	15	BES-8D	17		
AGA-14D	7	AL-1I	9	AME-2	10	ARC-11G	443	AS-16D	12	AS-GL5	13	AS-T5	13	AX-7P	126, 347	BAB-14D	16	BES-9D	17		
AGA-15	7	AL-2	9	AME-4	10	ARC-12G	443	AS-17D	318	AS-GL7	13	AS-T7	13	AX-7P	126, 347	BAB-17D	16	BES-10D	17		
AGA-15G	452	AL-3	9	AMG-1	10	ARC-13G	443	AS-17D	347	AS-GM5	13	AS-TT7	14	AYP-1G	444	BAB-19	15	BES-11D	17		
AGA-15G	452	ALA-1X	302	AMG-2D	10	ARC-14G	444	AS-18D	12	AS-GM7	13	AS-U5	13	AZ-1D	14	BAB-20D/2	15	BES-12D	17		
AGA-16I	8	ALC-1D	9	AMG-3D	10	ARC-15G	444	AS-19D	342	AS-H7	13	AS-U7	13	AZ-1I	14	BAG-1	126	BES-13D	17		
AGA-18D	7	ALE-1	9	AMG-4D	10	ARC-16G	444	AS-19D	12	AS-HH7	14	AS-UU7	14	AZ-2D	14	BAI-1D	16	BES-14D	17		
AGA-18I	7	ALE-1D	9	AMG-5D	10	ARC-17DP	11	AS-20D	12	AS-K7	13	AS-V5	13	AZ-2I	14	BAI-5D	16	BES-15D	17		
AGA-19D	7	ALE-1G	443	AMG-8D	125	ARC-17P	11	AS-21	318, 347	AS-KA7	14	AS-V7	13	AZ-3D	14	BAI-6	21	BES-16D	17		
AGA-19I	7	ALF-1	9	AMG-9D	125	ARC-18PG	444	AS-21D	318, 347	AS-KD7	14	AS-VV7	14	AZ-3I	14	BAI-7	21	BES-17D	17		
AGA-20	8	ALF-2	9	AMG-10	125	ARC-19PG	444	AS-21DP	318, 347	AS-KE5	14	AS-W5	13	AZ-4	15	BAI-8D	126	BEY-1D	127		
AGA-22	7	ALF-3	9	AMG-10D	125	ARC-20PG	444	AS-21P	318, 347	AS-KE7	14	AS-W7	13	AZ-6	15	BAI-9D	126	BEY-2D	127		
AGA-23	7	ALF-4	9	AMG-11	125	ARC-21PG	444	AS-22	12	AS-KF7	14	AS-WW7	14	AZ-7	15	BAI-12D	16	BH-1	157, 161, 228, 262,		
AGA-23G	452	ALF-5	9	AMG-12D	125	ARC-22PG	444	AS-23	12	AS-KG7	14	AS-X7	13	AZ-8D	126	BAI-13D	126	BH-1	282, 306, 307,		
AGA-24D	8	ALF-6	9	AMG-13D	10	ARC-23PG	444	AS-23D	12	AS-KK7	13	AS-XX7	14	AZ-9	126	BAN-1D	16	BH-1P	310, 351		
AGA-24I	8	ALF-7	9	AMG-14D	125	ARC-24G	444	AS-24	291, 291	AS-L7	13	AS-Z7	13	AZ-9D	126	BAN-1I	16	BH-1P	157, 161, 228, 262,		
AGA-25	124	ALF-8	9	AMG-15D	125	ARC-25G	444	AS-24D	267, 291	AS-LA7	14	ASC-1D	12	AZ-10	15	BAN-2D	16	BH-1P	282, 306, 307,		
AGA-27G	452	ALF-8D	9	AMM-1	159, 224, 257	ARC-26G	444	AS-25D	12	AS-LD7	14	ASH-2	126	AZ-12	126	BAN-3D	16	BH-2	310, 351		
AGA-29	124	ALF-9	9	AMM-1	303	ARC-27PG	444	AS-28	12	AS-LE7	14	ASI-1	12	AZ-14	126	BAO-1	16	BH-2	299, 306, 312		
AGA-29	124	ALF-10	9			ARE-1D	11	AS-30D	13	AS-LF7	14	ASP-1D	12	AZ-17	15	BAO-1D	16	BH-3	350		

Índice de referencias
Erreferentzia aurkibidea
Index des références

Referenzverzeichnis
Índice de referências
Spis modeli

REF.	PAG.	REF.	PAG.	REF.	PAG.	REF.	PAG.	REF.	PAG.	REF.	PAG.	REF.	PAG.	REF.	PAG.	REF.	PAG.		
BH-4	180, 246, 273, 340	BK-17/5PZ	19	BK-19/15	19	BL-4D	150, 193, 196, 199, 200, 215, 236, 257, 284, 288, 290, 299, 307, 309, 313, 320	BON-3G	387	BRI-31	127	BUR-5	22	CA-7	25	CE-27D	27	CE-84	27
BH-5	350	BK-17/6	19	BK-19/16	19	BL-5D	150	BOX-1G	415	BRI-32D	21	BUR-5D	22	CA-7D	25	CE-28D	27	CE-85	27
BH-6	350	BK-17/6PZ	19	BK-19/19	19	BL-6	150, 193, 196, 199, 200, 215, 236, 257, 284, 288, 290, 299, 307, 309, 313, 320	BRA-1	77	BRI-33	127	BUR-5X	303	CA-8D	25	CE-29D	27	CE-86	27
BH-8	157, 351	BK-17/7	19	BK-19/20	19	BL-6D	150, 193, 196, 199, 200, 215, 236, 257, 284, 288, 290, 309, 313, 320	BRA-2	20	BRI-34	127	BUR-6	22, 150, 342	CA-8I	25	CE-30D	27	CE-87	27
BI-1D	17	BK-17/7PZ	19	BK-19/21	19	BLT-1	16	BRAS-1	20	BRN-1D	127	BUR-7	22	CA-9I	25	CE-31D	27	CE-88	27
BI-2	17	BK-17/8	19	BK-19/23	19	BLU-1X	302	BRI-1	403	BRN-2D	127	BUR-8D	22	CA-10I	25	CE-32D	27	CE-89	28
BI-3D	17	BK-17/8PZ	19	BK-19/25	19	BLU-2X	302	BRI-1D	20	BRR-1	146	BUR-9	22	CA-11I	25	CE-33D	27	CE-89D	28
BI-E-1	17	BK-17/9	19	BK-19/26	19	BM-1P	168	BRI-1I	20	BRR-1	146	BUR-9D	22	CA-12I	25	CE-34D	27	CE-90D	28
BIF-1	17, 1	BK-17/9PZ	19	BK-19/27	19	BM-2	168	BRI-1X	302	BRS-1	20	BUR-10	22	CA-13D	25	CE-35D	27	CE-91	27
BIL-1T	146	BK-17D/1PZ	19	BK-19/31	19	BM-2P	168	BRI-2	403	BRU-1	21	BUR-10D	22	CA-14D	25	CE-36D	27	CE-92	27
BIL-1T	146	BK-17D/2PZ	19	BK-19/32	19	BM-3	168	BRI-2D	20	BRU-1D	21	BUR-11D	23	CA-15I	26	CE-37D	27	CE-92D	27
BK-1D	18	BK-17D/3PZ	19	BK-20	19	BM-3P	168	BRI-2I	20	BS-1I	159, 306, 350	BUR-12	23	CAB-1D	24	CE-38D	27	CE-93D	27
BK-1I	18	BK-17D/4PZ	19	BK-21/1	18	BM-4	168	BRI-2X	302	BS-2	159, 315	BUR-13D	23	CAF-1G	415	CE-39D	27	CE-94	28
BK-2D	18	BK-18	19	BK-21/2	18	BM-5P	168	BRI-3	403	BS-4D	224, 297, 303, 315, 351	BUR-14	23	CAF-2G	415	CE-40D	27	CE-96	28
BK-3D	18	BK-18/1	19	BK-21/3	18	BM-6P	168, 169	BRI-3D	20	BS-5	159, 257, 315	BUR-14D	23	CAM-1D	150	CE-41D	27	CE-97	28
BK-4	18	BK-18/2	19	BK-21/4	18	BM-6PIC1	169, 169	BRI-3I	20	BS-6	224, 282, 297, 303, 315, 326, 351	BUR-15	23	CAS-1D	337	CE-42D	27	CE-98D	28
BK-4	350	BK-18/3	19	BK-21/5	18	BM-B	168	BRI-3X	302	BS-7	326, 350	BUR-16	23	CAT-1P	350	CE-43D	27	CE-99D	26
BK-4D	18	BK-18/4	19	BK-21/6	18	BM-HB	169	BRI-4D	20	BS-8	351	BUR-17	23	CAT-2	350	CE-44D	27	CE-100D	26
BK-4D	351	BK-18/5	19	BK-21/7	18	BM-HBP	169	BRI-4I	20	BS-9D	351	BUR-17D	23	CAT-3	350	CE-45D	27	CE-101D	26
BK-5D	18	BK-18/6	19	BK-21/8	18	BM-HBP1	320	BRI-6D	20	BSS-1D	21	BUR-18D	23	CAY-1D	26	CE-46D	27	CE-102	28
BK-5D	351	BK-18/7	19	BK-21/9	18	BM-NB	169	BRI-6I	20	BSS-2D	21	BUR-19D	23	CAY-1D WINDCOLOR	26	CE-47D	27	CE-103	28
BK-5I	18	BK-18/9	19	BK-21/10	18	BM-NBP	169	BRI-6L1	403	BSS-3	21	BUR-20D	23	CAY-1I	26	CE-48D	27	CE-104D	28
BK-5I	351	BK-18/10	19	BK-21/14	18	BM-W	169	BRI-6L11	403	BSS-4D	21	BUR-21D	23	CAY-2	127	CE-49	27	CE-105	28
BK-6D	18	BK-18/11	19	BK-21/16	18	BMB-1	20	BRI-6L12	403	BSS-5D	21	BUR-22D	23	CCF-1X	303	CE-49D	27	CE-106	28
BK-6I	18	BK-18/12	19	BK-21/17	18	BMB-2	20	BRI-6L17	403	BSS-6D	21	BUR-23D	23	CCF-5X	303	CE-50	27	CE-107	28
BK-7D	18	BK-18/13	19	BK-21/19	18	BMB-3	20	BRI-6L18	403	BSS-7D	21	BUR-24	23	CCF-8X	303	CE-51	27	CE-108	26
BK-8D	18	BK-18/14	19	BK-22	18	BMB-3D	20	BRI-6L2	403	BTV-1D	21	BUR-24D	23	CCF-9X	303	CE-51D	27	CE-109D	28
BK-9	18	BK-18/15	19	BK-23	18	BMB-4	20	BRI-6L21	403	BTV-1I	21	BUR-25D	23	CCF-10X	303	CE-52	27	CE-110	26
BK-9	18	BK-18/16	19	BK-26/125	18	BMB-5	20	BRI-6L22	403	BTV-2D	21	BUR-26D	23	CE-1D	26	CE-53D	27	CE-111D	28
BK-14	18	BK-18/17	19	BK-26/135	18	BMC-1G	414	BRI-6L29	403	BTV-2I	21	BUR-27D	22	CE-1I	26	CE-54	28	CE-114	127
BK-16	18	BK-18/18	19	BK-26/145	18	BOB-1	20	BRI-6L30	403	BTV-3	21	BUR-28	23	CE-2D	26	CE-55	27	CE-117D	28
BK-16/0	18	BK-18/20	19	BK-26/235	18	BOD-1G	414	BRI-6L7	403	BU-1D	24	BUR-29	23	CE-2I	26	CE-56	27	CE-118D	27
BK-16/1	18	BK-18/21	19	BK-26/237	18	BOD-2G	414	BRI-6L8	403	BUL-1	127	BUR-29D	23	CE-3D	26	CE-57	27	CE-130	28
BK-16/10	18	BK-18/22	19	BK-26/245	18	BOD-3G	414	BRI-7D	20	BUL-2D	22	BUR-31D	24	CE-3I	26	CE-58	28	CE-131D	28
BK-16/11	18	BK-18/23	19	BK-26/246	18	BOD-4G	403	BRI-8I	20	BUL-3D	22	BUR-32D	24	CE-4D	26	CE-59	28	CE-132/15	28
BK-16/13	18	BK-18/24	19	BK-27	18	BOD-5G	403	BRI-9D	20	BUL-4D	22	BUR-33	127	CE-5	27	CE-5D	27	CE-132/16	28
BK-16/14	18	BK-18/25	19	BK-28	18	BOG-1G	414	BRI-10	20	BUL-5D	22	BUR-34	24	CE-6D	27	CE-60	28	CE-132/17	28
BK-16/15	18	BK-18/26	19	BKY-1	127	BOG-2G	414	BRI-12	20	BUL-6D	22	BUR-35D	24	CE-6I	27	CE-61	28	CE-132/18	28
BK-16/16	18	BK-18/27	19	BKY-2	127	BOM-1	20	BRI-13	20	BUL-7D	22	BUR-36	24	CE-7D	27	CE-62	28	CE-132/25	28
BK-16/17	18	BK-18/28	19	BL-1D	164, 284, 288, 289	BOM-1D	20	BRI-14	20	BUL-8D	22	BUR-36D	24	CE-7I	27	CE-63	28	CE-132/26	28
BK-16/18	18	BK-18/29	19	BL-1I	164, 284, 288, 289	BOM-2	236	BRI-14D	20	BUL-9D	22	BUR-37D	23	CE-8D	27	CE-64	28	CE-132/27	28
BK-16/19	18	BK-18/30	19	BL-2	150, 193, 196, 199, 200, 215, 236, 257, 284, 288, 290, 299, 307, 309, 313, 320	BOM-2	314	BRI-15	20	BUL-10D	22	BUR-38	22	CE-9D	27	CE-65	28	CE-132/35	28
BK-16/2	18	BK-18/31	19	BL-3	150, 193, 196, 199, 200, 215, 236, 257, 284, 288, 290, 299, 307, 309, 313, 320	BOM-2D	236	BRI-16	127	BUR-1	24	BUR-39	24	CE-10D	27	CE-66	28	CE-132/36	28
BK-16/20	18	BK-18/32	19	BL-4	150, 193, 196, 199, 200, 215, 236, 257, 284, 288, 290, 299, 307, 309, 313, 320	BOM-2	20	BRI-17	20	C	25	BUR-40D	24	CE-11D	27	CE-67	28	CE-132/37	28
BK-16/21	18	BK-18/33	19			BOM-2D	236	BRI-18	21	C-2	25	BUR-41	127	CE-12D	27	CE-68	28	CE-132/38	28
BK-16/23	18	BK-18/34	19			BOM-2D	314	BRI-18D	21	C-3G	457	BUR-42D	24	CE-13D	27	CE-69	28	CE-132/45	28
BK-16/3	18	BK-18/35	19			BOM-2D	20	BRI-19	21	C-3G(CV)	457	BUR-43	127	CE-14D	27	CE-70	28	CE-132/46	28
BK-16/30	18	BK-19	19			BOM-2D	20	BRI-19D	21	CA-1I	25	BUS-1	24	CE-15D	27	CE-71	28	CE-134	29
BK-16/4	18	BK-19/1	19			BOM-2D	20	BRI-19 WINDCOLOR	21	CA-2I	25	C-3G	457	CE-16D	27	CE-72	28	CE-136D/1	27
BK-16/5	18	BK-19/2	19			BOM-2D	20	BRI-20	20	CA-3I	25	C-3G	457	CE-17D	27	CE-73	28	CE-136D/2	27
BK-16/7	18	BK-19/4	19			BOM-2D	20	BRI-21	20	CA-4D	25	C-3G(CV)	457	CE-18D	27	CE-74	28	CE-136D/4	27
BK-16/9	18	BK-19/5	19			BOM-2D	20	BRI-22	21	CA-4I	25	CA-1I	25	CE-19D	27	CE-75	28	CE-136D/5	27
BK-17/1	19	BK-19/6	19			BOM-2D	20	BRI-23	21	CA-5I	25	CA-2I	25	CE-20D	27	CE-76	28	CEM-JC	178, 223, 265, 291
BK-17/1PZ	19	BK-19/7	19			BOM-2D	20	BRI-24	21	CA-6D	25	CA-3I	25	CE-21D	27	CE-77	27	CENT-1D	26
BK-17/2	19	BK-19/8	19			BOM-2D	20	BRI-25	127			CA-4D	25	CE-22D	27	CE-78	27	CENT-1I	26
BK-17/2PZ	19	BK-19/10	19			BOM-2D	20	BRI-26	127			CA-5I	25	CE-23D	27	CE-79	27	CENT-2D	26
BK-17/3	19	BK-19/11	19			BOM-2D	20	BRI-27	127			CA-6D	25	CE-24D	27	CE-80	27	CENT-2I	26
BK-17/4	19	BK-19/12	19			BOM-2D	20	BRI-28	127					CE-25D	27	CE-81	27	CENT-3D	26
BK-17/4PZ	19	BK-19/13	19			BOM-2D	20	BRI-29	127					CE-26D	27	CE-82	27	CENT-4	26
BK-17/5	19	BK-19/14	19			BOM-2D	20	BRI-30	127						27	CE-83	27	CER-1	26

Índice de referencias
Erreferentzia aurkibidea
Index des références

Referenzverzeichnis
Índice de referências
Spis modeli

REF.	PAG.	REF.	PAG.	REF.	PAG.
CER-1G	431	CHR-15	171, 255	CI-24	31
CER-2G	431	CHR-15P	171, 255	CI-25	128
CER-3G	431	CHR-17	180, 181, 240, 255	CI-26	128
CER-4G	431	CHTZ-1	29	CI-27	31
CF-1D	29	CHU-1D	29	CI-28D	31
CF-1I	29	CHU-1G	403	CI-29	31
CHA-2	29	CHU-2G	404	CI-30	128
CHA-2D	29	CHU-4G	416	CI-31	128
CHEK-1	29	CHU-5G	416	CI-32	128
CHI-1	29	CHU-10	29, 128	CI-33	128
CHI-1T	326	CI-1D	30	CI-34	31
CHI-1T	146	CI-1G	416	CI-34D	31
CHI-1T	146	CI-1I	30	CI-35	128
CHI-2	29	CI-1PG	416	CI-36	31
CHI-3	29	CI-2	31	CI-38D	31
CHI-4	29	CI-2G	416	CI-39D	30
CHI-5	29	CI-2I	31	CI-41	31
CHI-6	29	CI-3D	30	CI-42	31
CHI-7D	29	CI-3G	417	CI-43D	31
CHI-8D	29	CI-3PG	417	CI-44D	30
CHI-9D	29	CI-4D	30	CI-44D	347
CHI-10D	29	CI-4DP	30, 347	CI-45D	31
CHI-12D	29	CI-4G	417	CI-46D	31
CHR-1	170	CI-4I	30	CI-48	128
CHR-2	170	CI-4IP	30, 347	CI-48P	128
CHR-3	159, 172, 234, 249, 257, 260, 262, 276, 297, 308, 309, 311	CI-5DP	30	CI-49	31
CHR-3P	160, 172, 177, 249, 257, 262, 297, 309, 311	CI-5DP	347	CI-51	31
CHR-4D	170, 172, 249, 276	CI-5IP	30	CI-51D	31
CHR-4I	170, 172, 249, 276	CI-5IP	347	CI-53	31
CHR-5	308, 309	CI-5PG	417	CI-55D	31
CHR-6	150	CI-6D	30	CI-56	128
CHR-6D	150	CI-6G	417	CI-57	128
CHR-7	170, 180, 207, 254, 286	CI-6I	30	CI-58D	30
CHR-7P	170, 180, 207, 254, 286	CI-6PG	417	CI-59	128
CHR-8	170, 180, 207, 254, 286	CI-7D	30	CI-60	128
CHR-8P	170, 180, 207, 254, 286	CI-7TG	417	CI-61	31
CHR-9	160, 180, 224, 254	CI-8D	31	CI-62	31
CHR-9P	160, 180, 224, 254	CI-8G	417	CI-62D	31
CHR-10	160, 170, 180, 181, 224, 254	CI-9D	31	CI-63	31
CHR-10P	160, 171, 180, 181, 224, 254	CI-9PG	418	CI-63D	31
CHR-11P	284, 287	CI-10D	31	CI-64D	31
CHR-12	180, 254, 287	CI-10G	417	CI-65	31
CHR-13D	171, 180, 254, 287	CI-11D	31	CI-66D	31
CHR-14	160, 171, 180, 181, 202, 224, 254	CI-12	31	CI-67	128
CHR-14P	160, 171, 180, 181, 202, 225, 255	CI-12TG	417	CI-69	31
		CI-13	31	CI-70	31
		CI-13G	418	CI-71	128
		CI-14	128	CI-71P	128
		CI-15	31	CI-72	128
		CI-15D	31	CI-72P	128
		CI-16D	31	CI-73	128
		CI-17	128	CI-73P	128
		CI-18	31	CI-75P	128
		CI-19D	30	CI-76P	128
		CI-20	30	CI-77P	128
		CI-20D	30	CI-78P	128
		CI-21	128	CI-79P	128
		CI-22D	30	CI-80P	128
		CI-23D	30	CI-81	128
				CI-81P	128

REF.	PAG.	REF.	PAG.	REF.	PAG.
CI-82P	128	CLK-1	35	COR-27D	33
CI-83P	128	CLS-1D	32	COR-28	33
CI-84P	128	CLU-1D	350	COR-29D	34
CI-DL	31	CLU-1I	350	COR-30	34
CI-DL WINDCOLOR	31	CLU-2	350	COR-31	34
CI-IL	31	CLU-3	350	COR-32	34
CI-GDL	31	CLU-4	350	COR-33	34
CIF-1D	29	CLU-5	350	COR-34	34
CIF-1X	303	CMA-1	26	COR-35	34
CIF-2D	29	CMA-1D	26	COR-36D	32
CIF-3	29	CMA-2	26	COR-37	128
CIF-3D	29	CMA-2D	26	COR-3D	32
CIF-4	29	CML-1	24	COR-40	34
CIL-1	30	CN-1D	150	COR-48	32
CIL-1D	30	CN-1D	350	COR-49	32
CIL-2D	30	CNP-2D	24	COR-50-60	34
CIL-3D	30	CO-1D	35	COR-50-60I	34
CIL-4	30	COB-1P	347	COR-61	33
CIL-4D	30	COB-2	347	COR-62	34
CIL-5D	30	COH-1	32	COR-64	33
CIN-1	30	COH-2	32	COR-65	33
CIN-1D	30	COH-2D	32	COR-66	33
CIN-2	30	COH-3	32	COR-67	33
CIN-2D	30	COH-4	32	COR-68	33
CIS-1D	25	CO-M	35	COR-69	32
CIS-1I	25	COM-1D	32	COR-70	34
CIS-2	25	COR-1D	32	COR-70D	34
CIS-3	25	COR-1D WINDCOLOR	32	COR-71	33
CIS-4	25	COR-1GD	32	COR-72	33
CIS-5	25	COR-1I	32	COR-73	33
CIS-6D	25	COR-2D	32	COR-74	33
CIS-7D	25	COR-2I	32	COR-76D	32
CIS-803-1	453	COR-3	32	COR-77	128
CIS-803-2	453	COR-7	33	COR-78	34
CIS-803-3	453	COR-8	33	COR-79	32
CIS-803-4	453	COR-9	33	COR-80	32
CIS-803-5	453	COR-10	33	COR-114	34
CIS-803-6	453	COR-11	33	COR-115D	34
CIT-1C1	354, 356	COR-11D	33	COR-153	34
CL-1I	32	COR-12	33	COR-230	34
CL-2D	182, 320, 332, 334, 337, 338	COR-13	33	COR-231	35
CL-2I	182, 320, 332, 334, 337, 338	COR-13D	33	COR-232D	35
CL-3I	320, 332, 334, 337, 338	COR-15D	33	COT-1D	35
CL-4I	225	COR-16D	32	CR-1G	418
CL-6	268	COR-17D	33	CR-2G	418
CL-6P	268	COR-18D	32	CR-3G	419
CL-7P	157, 165, 171, 185, 192, 268, 293	COR-19D	32	DAC-4DC1	355
CL-8P	173	COR-20	33	DAC-4DC1	357
CL-9P	268	COR-20-25	33	DAC-4DC1	355
CLA-1G	418	COR-20D	33	DAC-4DP	176, 247, 262
CLA-2G	418	COR-21D	32	DAC-5C1	355
CLA-3G	418	COR-223	34	DAC-5C1	356
CLA-4G	418	COR-22D	32	DAC-6DC1	355
CLF-1	31	COR-23D	33	DAC-6DC1	357
CLI-1D	287	COR-24	33	DAC-6DP	247, 262
		COR-24D	33	DAC-7DC1	355
		COR-25	33	DAC-7DC1	357
		COR-25I	33	DAD-1D	35
		COR-26	33	DAD-1I	35
				DAD-2D	35
				DAD-2I	35

REF.	PAG.	REF.	PAG.	REF.	PAG.
COR-27D	33	CRT-2G	415	DAD-3D	35
COR-28	33	CRT-3G	415	DAD-4D	35
COR-29D	34	CRT-4G	415	DAD-5D	35
COR-30	34	CRT-7G	415	DAD-6D	35
COR-31	34	CRT-8G	415	DAE-1P	176
COR-32	34	CRT-10G	444	DAE-2DP	176
COR-33	34	CRT-11G	415	DAE-3D	176
COR-34	34	CRT-12G	416	DAE-3DPI	176, 274
COR-35	34	CRT-13G	416	DAE-3DP2	170, 176, 205
COR-36D	32	CRT-14G	416	DAE-3P2	170, 176, 205
COR-37	128	CRT-15G	416	DAE-4D	176
COR-3D	32	CRT-17G	416	DAE-4DP1	176
COR-40	34	CRT-18G	416	DAE-4P1	176
COR-48	32	CSB-1D	25	DAE-5P	170, 176
COR-49	32	CSB-2D	25	DAF-1	36
COR-50-60	34	CT-1	172, 299	DAF-1D	36
COR-50-60I	34	CT-1P	172, 299	DAF-2	128
COR-61	33	CT-2	172	DAF-3D	128
COR-62	34	CT-2P	172	DAF-4D	128
COR-64	33	CT-2P1	172	DAI-1P	167, 177, 254
COR-65	33	CT-3	172, 233, 299	DAI-2D	178
COR-66	33	CT-3P	172, 233, 299	DAL-01P	342
COR-67	33	CT-4P	173	DAS-1D	128
COR-68	33	CUB-1	35	DAT-1I	242, 245, 272
COR-69	32	CVL-1D	35	DAT-1IP	242, 245, 272
COR-70	34	CVL-1I	35	DAT-1D	242, 245, 272
COR-70D	34	CVL-2D	35	DAT-1DP	242, 245, 272
COR-71	33	CVL-2I	35	DAT-2D	242, 245, 272
COR-72	33	CVL-3D	35	DAT-2DP	242, 245, 272
COR-73	33	CVL-3I	35	DAT-2I	242, 245, 272
COR-74	33	CVL-4	35	DAT-2IP	242, 245, 272
COR-76D	32	CVL-5D	35	DAT-3D	234, 242, 273
COR-77	128	CVL-5D WINDCOLOR	35	DAT-3D	242
COR-78	34	CVL-5I	35	DAT-3I	234, 242, 273
COR-79	32	CVL-5I WINDCOLOR	35	DAT-4D	234, 242, 273
COR-80	32	CVL-6	35	DAT-4I	234, 242, 273
COR-114	34	CVL-8D	35	DAT-5D	242
COR-115D	34	CVL-9D	128	DAT-6	157, 179, 182, 218, 243, 245, 272
COR-153	34	D-3G	457	DAT-6	304, 305, 309, 309
COR-230	34	D-3G(CV)	457	DAT-6C1	357
COR-231	35	DAC-1DP	175	DAT-6D	157, 179, 182, 218, 243, 245, 272, 304, 305, 309
COR-232D	35	DAC-2D	175	DAT-6DP	157, 179, 182, 218, 243, 245, 272
COT-1D	35	DAC-3DC1	355	DAT-6DP1	218, 243, 272
CR-1G	418	DAC-3DC1	357	DAT-6DP1	304, 305, 309, 304, 305, 309
CR-2G	418	DAC-4DC1	355	DAT-6P	157, 179, 183, 218, 243, 245, 246, 272, 309
CR-3G	419	DAC-4DC1	357	DAT-6P1	218, 243, 272, 304, 305, 309
CR-4G	419	DAC-4DC1	355	DAT-7	157, 179, 182, 218, 243, 245, 272, 304, 305, 309
CR-5G	419	DAC-4DP	176, 247, 262	DAT-7P	157, 179, 183, 218, 243, 245, 246, 272
CR-8G	419	DAC-5C1	355		
CR-11G	419	DAC-5C1	356		
CR-12G	419	DAC-6DC1	355		
CR-14G	419	DAC-6DC1	357		
CR-17TG	419	DAC-6DP	247, 262		
CR-18G	419	DAC-7DC1	355		
CR-19G	420	DAC-7DC1	357		
CR-1X	303	DAD-1D	35		
CRF-1D	24	DAD-1I	35		
CRN-1G	418	DAD-2D	35		
CRO-1G	447	DAD-2I	35		
CRT-1G	415				

REF.	PAG.	REF.	PAG.	REF.	PAG.
DAD-3D	35	DAT-7P1	218, 243, 272, 304, 305, 309	DEK-13	36
DAD-4D	35	DAT-8D	243, 273	DEK-14D	36
DAD-5D	35	DAT-8I	243, 273	DEK-16	129
DAD-6D	35	DAT-8IP	243, 273	DEK-17	129
DAE-1P	176	DAT-8IP1	243, 273	DEN-1	420
DAE-2DP	176	DAT-8P	243, 273	DIA-1	36
DAE-3D	176	DAT-9D	243, 273	DIA-2	36
DAE-3DPI	176, 274	DAT-9DP	243, 273	DIA-3	36
DAE-3DP2	170, 176, 205	DAT-9I	243, 273	DIE-1	37
DAE-3P2	170, 176, 205	DAT-10	218, 243	DIE-1	460
DAE-4D	176	DAT-10P	218, 243	DLC-1	129
DAE-4DP1	176	DAT-11	234, 243, 273	DLC-2	129
DAE-5P	170, 176	DAT-11P	234, 244, 273	DLC-3	129
DAF-1	36	DAT-12	212, 244, 245, 246	DLM-1D	36
DAF-1D	36	DAT-12	309	DLP-1	36
DAF-2	128	DAT-13	218, 244	DLP-2	36
DAF					

Índice de referencias
Erreferentzia aurkibidea
Index des références

Referenzverzeichnis
Índice de referências
Spis modeli

REF.	PAG.	REF.	PAG.	REF.	PAG.	REF.	PAG.	REF.	PAG.	REF.	PAG.	REF.	PAG.	REF.	PAG.	REF.	PAG.	REF.	PAG.	
DOM-9D	37	DOM-27D/43	39	DOM-59	40	E-3G	457	EST-1G	422	EV-25D	43	FA-5G	406	FAR-2D	151, 184, 219, 249,	FB-31	45	FF-9D	48	
DOM-10D	37	DOM-27D/44	39	DOM-60D	40	E-3G(CV)	457	EST-2G	422	EV-27D/1	44	FA-6G	406		257, 319, 322,	FB-32	45	FF-10D	47	
DOM-11D	37	DOM-27D/45	39	DOM-61	40	EAG-2D	41	EST-3G	422	EV-27D/10	44	FA-7G	406		325, 327, 331,	FB-33	45	FF-10GD	48	
DOM-11I	37	DOM-27D/46	39	DOM-62D	40	EC-1	41	EST-4G	422	EV-27D/2	44	FA-9G	424		336, 341, 347	FB-34	45	FF-11	47	
DOM-12	37	DOM-27D/47	39	DOM-63D	130	EC-1D	41	EST-5G	423	EV-27D/3	44	FA-10G	425	FAR-2I	151, 184, 219, 249,	FB-35	45	FF-13	131	
DOM-12D	37	DOM-27D/48	39	DOM-64D	40	ECH-1	150	EST-5TG	423	EV-27D/4	44	FA-11G	406		257, 319, 322,	FB-38	45	FI-1	165, 185, 188, 190,	
DOM-13D	38	DOM-27D/49	39	DOM-65	40	EG-1	41	EST-6G	423	EV-27D/5	44	FAB-1	150, 157, 165, 173,		325, 327, 331,	FB-39	45		228, 256, 271,	
DOM-14D	38	DOM-27D/5	38	DOM-66D	40	EG-2	41	EST-7G	423	EV-27D/6	44		527, 310, 318,	FAR-3	151, 184, 219, 249,	FB-41	45		321, 325, 338	
DOM-15D	38	DOM-27D/50	39	DOM-67D	40	EI-1D	41	EST-10G	423	EV-27D/7	44		322, 327, 334,		257, 319, 322,	FCS-1D	48	FI-1P	165, 185, 188, 190,	
DOM-16D	38	DOM-27D/51	39	DOM-68	40	EI-2D	41	EST-11G	423	EV-27D/8	44		336, 341, 347		325, 327, 331,	FEB-1G	425		228, 256, 271,	
DOM-17I	129	DOM-27D/52	39	DOM-71D	40	ELB-1G	421	ETS-1D	42	EV-27D/9	44	FAB-2	185		336, 341, 347	FEB-2G	425		299, 321, 325,	
DOM-18D	38	DOM-27D/53	39	DOM-72D	39	ELB-2G	421	EU-1	43	EV-27D/0	44	FAC-1D	45	FAR-3	151, 184, 219, 249,	FEC-1D	47	FI-1P8	165, 192	
DOM-20D	38	DOM-27D/54	39	DOM-73D	40	ELB-3G	421	EU-2	43	EV-29D/0	44	FAC-1G	424		257, 319, 322,	FEC-2	47	FI-2D	158, 165, 173, 186,	
DOM-21D	37	DOM-27D/55	39	DOM-74D	39	ELZ-1D	41	EU-3	43	EV-30	44	FAC-1I	45		325, 327, 331,	FEC-3D	47		191, 192, 249,	
DOM-22	129	DOM-27D/56	39	DOM-75	37	ELZ-1G	422	EU-4	43	EV-31	44	FAC-2D	45	FAR-3D	151, 184, 219, 249,	FED-1	47		268, 293, 300	
DOM-25D	38	DOM-27D/57	39	DOM-76D	38	ELZ-2	41	EU-4D	43	EVE-1	43	FAC-2G	424		257, 319, 322,	FED-2	47	FI-2DP3	158, 166, 173, 186,	
DOM-26	38	DOM-27D/58	39	DOM-77D	40	ELZ-2G	405	EU-6	43	EVE-1D	43	FAC-2I	45		325, 327, 331,	FED-3	47		173, 191, 192, 228,	
DOM-26D	38	DOM-27D/59	39	DOM-78D	37	ELZ-3D	41	EU-7	43	EVE-2	43	FAC-3D	45		336, 341, 347	FEM-1D	165, 168, 185, 191,		250, 300	
DOM-27/12	38	DOM-27D/6	38	DOM-79D	37	ELZ-3G	405	EU-7D	43	EVE-2D	43	FAC-3G	424	FAR-4D	151, 184, 219, 249,		246, 256, 299,	FI-3	158, 165, 173, 186,	
DOM-27/13	38	DOM-27D/60	39	DOM-80	37	ELZ-4	41	EU-8D	43	EVE-3D	43	FAC-3I	45		257, 319, 322,		310, 317, 320,		191, 192, 249,	
DOM-27/16	38	DOM-27D/61	39	DOM-80D	37	ELZ-4D	41	EU-9	43	EVE-4	43	FAC-4D	45		325, 327, 331,		322, 325, 334,		268, 293, 300	
DOM-27/19	38	DOM-27D/7	38	DOM-81	37	ELZ-4G	422	EU-10D	43	EX-1D	44	FAC-4G	424		336, 341, 347		335, 336, 338	FI-3D	158, 165, 173, 186,	
DOM-27/35	38	DOM-27D/8	38	DOM-B1	130	ELZ-5D	41	EU-11	43	EXS-1D	44	FAC-5D	45	FAS-1	46		165, 168, 185, 191,		191, 192, 249,	
DOM-27D/1	38	DOM-27D/9	38	DOM-B2	130	ELZ-5G	405	EU-12	130	EXS-2D	44	FAC-6D	45	FAV-1D	131	FEM-1I	246, 256, 299,		268, 293, 300	
DOM-27D/10	38	DOM-28	39	DOM-B6	130	ELZ-6D	41	EU-13D	43	EXS-3	44	FAC-7D	46	FAV-2	131		310, 317, 320,	FI-3DP	158, 173, 186, 219,	
DOM-27D/11	38	DOM-28D	39	DR-1	129	ELZ-6G	405	EU-14D	43	EXS-3D	44	FAC-8D	45	FAV-3	47		322, 325, 334,		228, 268, 293	
DOM-27D/12	38	DOM-29	39	DR-2D	129	ELZ-7G	422	EU-15P	350	EXS-4D	44	FAC-9D	45	FAV-3D	47	FI-3DP1	158, 186, 191, 192,			
DOM-27D/13	38	DOM-30	129	DUP-1G	447	ELZ-8D	41	EU-16DP	350	EXS-5	44	FAC-10D	45	FAY-1D	131		246, 256, 299,		300	
DOM-27D/14	38	DOM-31	129	DUR-1D	41	ELZ-9	41	EU-17	43	EXS-5D	44	FAC-11D	46	FAY-1X	304	FI-3DP2	186, 191			
DOM-27D/15	38	DOM-32	129	DV-1G	420	ELZ-10	130	EU-18	42	EXS-6	44	FAC-12D	45	FB-1	45	FI-3DP3	158, 166, 173, 186,			
DOM-27D/16	38	DOM-33	129	DV-2G	447	ELZ-10D	130	EUB-1	42	EZ-1D	44	FAC-13D	46	FB-2D	45		322, 325, 334,		173, 191, 192, 228,	
DOM-27D/17	38	DOM-34	130	DV-3G	420	ELZ-11D	41	EUB-2D	42	EZ-1G	424	FAC-14D	46	FB-2I	45	FEM-2I	165, 168, 185, 191,		250, 300	
DOM-27D/18	38	DOM-35	39	DV-4G	447	ELZ-12	41	EUP-4D	43	EZ-1I	44	FAC-15	46	FB-3	45		246, 256, 299,	FI-3DP4	158, 186, 300	
DOM-27D/19	38	DOM-35D	39	DV-5G	420	ELZ-12D	41	EUR-1D	42	EZ-2G	424	FAC-18	46	FB-4	45		310, 317, 320,	FI-3DP5	158, 186, 219,	
DOM-27D/2	38	DOM-36	39	DV-6G	420	ELZ-13	130	EUR-1D	42	EZ-2I	44	FAC-19	130	FB-5	45		322, 325, 334,		294, 300	
DOM-27D/20	38	DOM-36D	39	DV-7G	420	EMK-1	41	EUS-1G	405	EZ-3D	44	FAC-20D	46	FB-6	45	FEM-2D	165, 168, 185, 191,			
DOM-27D/21	38	DOM-37	39	DV-8G	420	EP-1D	42	EUT-1G	423	EZ-3G	424	FAC-21	46	FB-7	45		246, 256, 299,			
DOM-27D/22	38	DOM-37D	39	DV-9G	420	ER-1D	42	EUT-2G	423	EZ-3I	44	FAC-21D	46	FB-8	45		310, 317, 320,			
DOM-27D/23	38	DOM-38D	39	DV-10G	421	ER-1G	405	EUT-3G	423	EZ-4D	44	FAC-22D	46	FB-9	45		322, 325, 334,			
DOM-27D/24	38	DOM-39	130	DV-10G-A	448	ER-2D	42	EV-1	43	EZ-4G	424	FAC-23	130	FB-10	45		335, 336, 338			
DOM-27D/25	38	DOM-40	39	DV-11G	448	ER-3	42	EV-2	43	EZ-4I	44	FAC-24	130	FB-11	45	FEM-3I	165, 168, 185, 191,			
DOM-27D/26	38	DOM-40D	39	DV-12G	421	ER-4D	42	EV-2I	43	EZ-5G	424	FAC-25	131	FB-12	45		246, 256, 299,			
DOM-27D/27	38	DOM-41D	38	DV-13G	421	ER-4G	405	EV-3D	43	EZ-6G	424	FAIN-1I	46	FB-13	45		310, 317, 320,			
DOM-27D/28	38	DOM-42	39	DV-13G-A	448	ER-5G	405	EV-4D	43	EZ-7G	424	FAIN-1I WINDCOLOR	46	FB-14	45		322, 325, 334,			
DOM-27D/29	38	DOM-43	130	DV-14G	421	ERV-1G	422	EV-6D	44	EZ-8G	424	FAL-1D	46	FB-15	45		335, 336, 338			
DOM-27D/3	38	DOM-44D	37	DV-15G	421	ERV-2G	422	EV-7D	44	EZ-11G	424	FAL-2D	46	FB-16	45	FER-1	47			
DOM-27D/30	38	DOM-45	37	DV-16G	421	ERV-3G	422	EV-8D	44	EZ-DS10	130	FAM-1	46	FB-17	45	FER-2D	131			
DOM-27D/31	38	DOM-46D	37	DV-17G	448	ERV-3G-A	448	EV-9D	44	EZ-DS10E	130	FAM-2	46	FB-18	45	FER-3D	47			
DOM-27D/32	38	DOM-48	37	DV-18G	421	ES-1D	42	EV-10	43	EZ-DS15	130	FAN-1	46	FB-19	45	FER-4D	47			
DOM-27D/33	38	DOM-49D	38	DV-19G	421	ES-1G	405	EV-11	44	EZ-DS15R	130	FAN-1D	46	FB-20	45	FET-1G	425			
DOM-27D/34	38	DOM-51	39	DX-5	36	ES-1I	42	EV-11D	44	FAR-1D	151, 184, 219, 249,		46	FB-21	45	FF-1	47	FI-6IP	184, 186, 191, 192,	
DOM-27D/35	38	DOM-52	39	DX-5D	36	ESL-1	42	EV-12D	44		257, 319, 322,		46	FB-22	45	FF-1D	47		219, 229, 294,	
DOM-27D/36	38	DOM-53D	39	DX-6	36	ESL-1D	42	EV-13D	43	FA-1	46		46	FB-23	45	FF-2	47	FI-6IP3	166, 173, 184, 192,	
DOM-27D/37	39	DOM-54D	39	DX-6D	36	ESP-4D	42	EV-14	44	FA-1D	46		46	FB-24	45	FF-2D	47		294, 305, 321,	
DOM-27D/38	39	DOM-55	40	E-0G	457	ESS-1	42	EV-15D	43	FA-1G	405	FAR-1I	151, 184, 219, 249,	FB-25	45	FF-3	47		323, 323, 324,	
DOM-27D/39	39	DOM-55D	40	E-0G(CV)	457	ESS-2	42	EV-19	44	FA-2G	405		257, 319, 322,	FB-26	45	FF-5D	47		325	
DOM-27D/4	38	DOM-56D	130	E-1G	457	ESS-3	42	EV-20D	44	FA-2PPG	405		325, 327, 331,	FB-27	45	FF-6	47	FI-6IP4	157, 165, 184, 185,	
DOM-27D/40	39	DOM-57	40	E-1G(CV)	457	ESS-4	42	EV-23D	44	FA-3G	406		336, 341, 347	FB-28	45	FF-7D	48		219, 228, 299,	
DOM-27D/41	39	DOM-57D	40	E-2G	457	ESS-9	42	EV-24	44	FA-3PPG	406			FB-29	45	FF-8D	48		320, 322, 323,	
DOM-27D/42	39	DOM-58D	39	E-2G(CV)	457	ESS-9D	42			FA-4G	406									324, 325

Índice de referencias
Erreferentzia aurkibidea
Index des références

Referenzverzeichnis
Índice de referências
Spis modeli

REF.	PAG.
FI-7I	186
FI-8I	166, 186, 188, 192, 268
FI-8IP	166, 186, 188, 192, 268
FI-8IP1	186, 193
FI-9I	158, 166, 186, 188, 193, 229, 246, 268, 271, 300
FI-9IP	158, 166, 187, 189, 193, 229, 246, 268, 271, 300
FI-10	165, 185, 188, 190, 228, 256, 271, 321, 325, 338
FI-10P	165, 185, 188, 190, 228, 256, 271, 299, 321, 325, 338
FI-11	166, 187, 189, 190, 193, 219, 229, 256, 271, 300, 317
FI-11P	166, 174, 187, 189, 190, 193, 219, 229, 257, 271, 300, 317
FI-12	158, 165, 173, 186, 191, 192, 249, 268, 293, 300
FI-12DP3	158, 166, 186, 173, 191, 192, 250
FI-12P	158, 173, 186, 219, 228, 268, 293
FI-12P1	158, 186, 191, 192, 300
FI-12P3	158, 166, 173, 186, 173, 191, 192, 228, 250, 300
FI-13	158, 187, 189, 191, 229
FI-13P	158, 187, 189, 191, 229
FI-13P1	158, 187, 187, 190, 229, 338
FI-13P7	158, 19
FI-14P	159, 187, 191, 229, 187
FI-15	187
FI-16C1	354, 355, 356
FI-16C3	354, 355, 356
FI-16P1	155, 159, 171, 173, 229
FIA-1	350
FIA-2	187
FIC-1	48
FIC-2	48
FIC-5	48
FIC-7	48
FIC-8	48
FIC-9	48
FIC-18	48
FIC-400	406
FIC-401G	406

REF.	PAG.
FIS-1D	48, 193, 300, 321
FLO-1	48
FLO-1D	48
FLO-2D	350
FLT-1	50
FLT-1D	50
FM-1G	425
FM-1X	304
FM-2G	425
FM-2X	304
FM-3G	425
FM-4G	425
FM-4TG	425
FM-5G	425
FM-6G	426
FM-7G	426
FM-8G	426
FM-13G	426
FM-14G	426
FM-15G	426
FM-16G	426
FM-17G	426
FM-20G	426
FM-21G	426
FO-1	196, 198, 199, 200, 231, 238
FO-2	196, 198, 199, 200, 231, 234, 238
FO-3	196, 199, 200, 231, 238
FO-3D	196, 199, 200, 231, 238
FO-3DP	196, 199
FO-3P	196, 199
FO-4P	193, 196, 199, 200, 201
FO-5	178, 223, 265, 291
FO-6P	193, 196, 199, 200, 201, 234
FO-7P	201, 238
FO-8	193, 201, 238
FO-8D	193, 201, 238, 244
FO-8DP	201, 238, 244
FO-8DP1	238, 245
FO-9D	193, 201
FO-9DP	194, 201
FO-9DP	194, 201
FO-10P	194
FO-11D	196, 201, 231, 238, 302
FO-12	198, 201
FO-12P	198, 201
FO-13DP	198, 201
FO-14DP	198, 201, 239
FO-15D	198, 201, 239, 302
FO-15DP	196, 198, 201, 239, 302

REF.	PAG.
FO-17P	196, 199
FO-18D	194
FO-20D	201, 231, 239, 302
FO-TX	162, 195, 197, 198, 199, 200, 202, 302
FO-TX1	195, 197, 199, 200
FO-TX1P	195, 197, 199, 200
FO-TX2	195, 197, 199, 200
FO-TX2P	195, 197, 200
FO-TXP	162, 195, 197, 198, 200, 202, 302
FO-XL	195, 198, 239
FO-XR	195, 198
FORTIS-2I	49
FR-1D	49
FR-2	49
FR-4	49
FR-7D	49
FR-8	49
FR-9D	49
FR-11D	49
FRI-1X	304
FRI-2X	304
FTE-1	49
FTE-1D	49
FV-1D	47
FV-3	131
GAB-1D	50
GAB-1I	50
GAB-2	50
GARD-1G	427
GARD-2G	427
GAS-1	197, 253, 261, 287
GAS-1D	197, 253, 261, 287
GAT-1	51
GAT-2D	51
GAT-3D	51
GB-1D	54
GB-2D	54
GB-3D	132
GBZ-1	51
GD-1P	347
GD-1DP	347
GDA-1P	131
GDA-3D	52
GDA-4D	131
GDA-5	53
GDA-6D	53
GDA-7D	53
GDA-8D	53
GDA-30D	53
GDA-50D	53
GDA-60D	53
GE-1D	51
GE-2	51
GE-3D	51
GE-4D	51
GE-5	51
GE-5D	51
GE-6	51
GE-6D	51
GE-7	51

REF.	PAG.
GE-8	51
GE-9	51
GE-10D	52
GE-11	52
GE-15D	51
GE-16D	51
GE-19	51
GE-21	52
GE-21D	52
GE-22/1	51
GE-22/11	51
GE-22/12	51
GE-22/13	51
GE-22/15	51
GE-22/16	51
GE-22/17	51
GE-22/18	51
GE-22/19	51
GE-22/2	51
GE-22/3	51
GE-22/4	51
GE-22/5	51
GE-22/6	51
GE-22/7	51
GE-22/8	51
GEA-1	52
GEA-1X	304
GEA-2D	52
GEA-3	52
GEA-3X	304
GEA-4D	52
GEA-5D	52
GEA-6D	52
GEA-7D	52
GEA-8D	52
GEA-9/1	52
GEA-9/3	52
GEA-9/4	52
GEA-9/6	52
GEA-9/7	52
GEA-9/9	52
GEA-9/10	52
GEA-9/11	52
GEA-9/13	52
GEA-9/14	52
GEA-9D/12	52
GEA-9D/2	52
GEA-9D/5	52
GEA-9D/7	52
GEA-9D/8	52
GEB-1D	52
GER-2G	427
GER-3G	427
GER-4G	427
GER-5G	427
GEV-3D	131
GH-1	151
GH-2	151
GH-3	151

REF.	PAG.
GH-GX	351
GH-HX	351
GH-PS	151
GIB-ID	53
GIM-ITG	427
GIOB-1D	229
GIOB-1DP	229
GIOB-2I	229, 234
GIOB-2IP	229, 234
GIOB-3P2	159
GIU-1	53
GIU-ID	53
GIU-2	53
GIU-2D	53
GIU-3D	53
GIU-4	53
GLA-ID	53
GLA-2D	53
GLO-1D	53
GLO-1I	53
GLO-2	53
GLO-2D	53
GLO-3	53
GLO-3D	53
GLO-4D	53
GLO-4I	53
GLO-5I	54
GLO-6	54
GLO-6D	54
GLO-7	54
GLO-7D	54
GLO-8	54
GLO-8D	54
GLO-9D	54
GLO-10	54
GLO-11	54
GLO-12D	54
GLO-22	54
GLO-22D	54
GLO-23D	54
GM-1P	167, 205, 221
GM-2	205, 208, 212, 221
GM-2P	205, 208, 212, 222
GM-3P	203, 204, 205, 209
GM-4	222, 247
GM-4P	222, 247
GM-4P1	222, 247
GM-5	155, 208, 222, 304
GM-5P	155, 208, 214, 222, 304
GM-6	160, 203, 204, 205, 207, 209, 210, 212, 220, 221, 247

REF.	PAG.
GM-6P	160, 203, 204, 205, 207, 209, 210, 212, 220, 221, 248
GM-7	160, 203, 204, 205, 207, 209, 210, 212, 221, 247
GM-7P	160, 203, 204, 205, 207, 209, 210, 212, 221, 248
GM-8	160, 203, 204, 205, 207, 209, 210, 212, 221, 247
GM-8P	160, 203, 204, 205, 207, 209, 210, 212, 221, 248
GM-9	160, 203, 204, 205, 207, 209, 210, 212, 225, 221, 247
GM-9P	160, 203, 204, 205, 207, 209, 210, 212, 225, 221, 248
GM-10	203, 204, 205, 207, 209, 211, 212, 220, 232
GM-10P	203, 204, 205, 207, 209, 211, 212, 220, 232
GM-11	203, 204, 205, 207, 209, 211, 212, 220, 232
GM-11P	203, 204, 205, 207, 209, 211, 212, 220, 232
GM-12P	203, 204, 205, 207, 209, 211, 212, 220, 232
GM-13	203, 204, 205, 207, 209, 211, 212, 220, 232
GM-13P	203, 204, 205, 207, 209, 211, 212, 220, 232
GM-14	203, 205, 210, 211, 314
GM-14P	202, 203, 205, 210, 211, 314
GM-15D	222
GM-15DP	222
GM-16P	204, 206
GM-17P	204, 206
GM-18P	204, 206
GM-19P	203, 206, 210, 211
GM-20P	203, 206, 210, 211
GM-21	212
GM-21P	212
GM-22	203, 206, 210, 211

REF.	PAG.
GM-22P	203, 206, 210, 211
GM-23	203, 206, 210, 211
GM-23P	203, 206, 210, 211
GM-24	208
GM-24P	208
GM-25	203, 206, 210, 211, 314
GM-25P	202, 203, 206, 210, 211, 314
GM-26	203, 204, 206, 209
GM-42	212
GM-A	160, 204, 206, 207, 209, 210, 211, 212, 220, 221, 225, 248
GM-AP	160, 204, 206, 207, 209, 210, 211, 213, 220, 221, 225, 248
GM-B	204, 205, 206, 207, 209, 210, 211, 213, 221, 232
GM-BP	204, 205, 206, 207, 209, 210, 211, 213, 221, 232
GM-C	160, 204, 206, 207, 209, 210, 211, 212, 221, 225, 248
GM-CP	160, 204, 206, 207, 209, 210, 211, 213, 221, 225, 248
GM-D	204, 205, 206, 207, 209, 210, 211, 213, 232
GM-DP	204, 205, 206, 207, 209, 210, 211, 213, 232
GM-E	160, 204, 206, 207, 209, 210, 211, 212, 221, 225, 248
GM-EP	160, 204, 206, 207, 209, 210, 211, 213, 221, 225, 248
GM-H	204, 205, 206, 207, 209, 210, 211, 213, 232
GM-HP	204, 205, 206, 207, 209, 210, 211, 213, 232
GM-J	160, 204, 206, 207, 209, 210, 211, 212, 221, 225, 248
GM-JP	160, 204, 206, 207, 209, 210, 211, 213, 221, 225, 248

REF.	PAG.
GM-K	204, 205, 206, 207, 209, 210, 211, 213, 232
GM-KP	204, 205, 206, 207, 209, 210, 211, 213, 232
GMG-1G	428
GMG-2G	428
GMT-1	51
GMT-2	51
GMT-3D	51
GMT-4D	51
GMT-5D	51
GMT-7D	51
GMT-8D	51
GOD-1	132
GOD-2	132
GOD-3	54
GOD-4	54
GPS-1G	427
GPS-2G	427
GPZ-1G	406
GR-1D	55
GR-1I	55
GR-2D	55
GR-2I	55
GR-3D	55
GR-3I	55
GR-4D	55
GR-4I	55
GR-5D	55
GR-5I	55
GR-6	55
GR-6D	55
GR-7	55
GR-7D	55
GR-8	55
GRG-1	54
GTV-1D	55
GTV-2	55
GTV-2D	55
GTV-3D	55
GTV-4D	55
GTV-5D	55
GTV-10	55
GTV-11	55
GTV-12	55
GUA-1	55
GUA-1D	55
GUA-2	55
GUA-2D	55
GUA-3	55
GUA-3D	55
GUA-4	55
GUA-4D	55
GUA-5	55
GUA-5D	55
GUR-1G	407
GUS-1	55
GW-1D	342

REF.	PAG.
H-3G	457
H-3G(CV)	457
HA-1D	195
HA-1I	195
HAF-1	55
HAF-1D	55
HAF-2	56
HAF-2D	56
HAF-3D	56
HAF-4	55
HAF-6	56
HAG-1D	56
HAK-1D	56
HAK-2D	56
HAK-3	56
HAK-4	56
HAK-5	56
HAL-1	56
HAR-1I	56
HAW-1D	56
HAW-2D	56
HAW-3D	56
HAW-4D	56
HB-1	132
HD-1	326
HD-1D	326
HD-2	326
HD-2D	326
HD-3	326
HD-3D	326
HD-4D	326
HEK-1	56
HEK-2	56
HEK-3	56
HEK-4	56
HEK-4D	56
HEK-5	56
HEK-6	56
HEL-1	56
HEN-1	56
HEN-1D	56
HEN-1GP	407

Índice de referencias
Erreferentzia aurkibidea
Index des références

Referenzverzeichnis
Índice de referências
Spis modeli

REF.	PAG.	REF.	PAG.	REF.	PAG.
HOND-3I	327	HOND-43D	328	HUD-3	57
HOND-4D	327	HOND-43DP	328	HUD-3D	57
HOND-4DP	327	HOND-43P	328	HUN-1D	57
HOND-4DP1	327	HOND-45D	329	HUW-1	57
HOND-4DP2	327	HOND-46D	329	HUW-2	58
HOND-4I	327, 331	HOND-49	329	HUW-3D	132
HOND-4IP	327, 331	HOR-1	57	HUW-N	58
HOND-4IP1	327	HOR-2	57	HY-1	215
HOND-5D	327	HOR-2D	57	HY-2	215
HOND-5I	327	HRM-1	57	HY-2P	215
HOND-6D	327	HT-1	57	HY-3	215, 24
HOND-6I	327	HTE-1D	57	HY-3D	215, 24
HOND-7D	327	HTE-50	132	HY-3DP	215
HOND-7I	327	HU-1	162, 184	HY-3DP1	216, 24
HOND-8D	327	HU-2P	313	HY-3DP2	216, 27
HOND-8I	327	HU-4CI	354, 357, 358	HY-3P2	216, 27
HOND-9D	327	HU-7C1	354, 357, 358	HY-3P3	270
HOND-9I	327	HU-AN	285, 288, 290	HY-4	216
HOND-10	155, 214, 265	HU-DF	291	HY-4P	216
HOND-10P	155, 214, 265	HU-DFP	291	HY-4P2	216
HOND-11	155, 214, 265	HU-DHP	291	HY-4P3	216
HOND-11P	155, 214, 265	HU-DNP	291	HY-5	216, 27
HOND-12	214	HU-HAAC1	354, 357, 358	HY-5P	216, 27
HOND-12P	214	HU-HAAC2	354, 357, 358	HY-6D	216
HOND-13	214	HU-HAAC3	354, 358	HY-6DP	216
HOND-13P	214	HU-HAAC4	358	HY-7P	216
HOND-14	214	HU-HAAC5	358	HY-8	216
HOND-14P	214	HU-HAAP1	285	HY-8P	216
HOND-15	156, 215	HU-HCAP	173, 25	HY-9P2	216
HOND-15P	156, 215	HU-MN	307	HY-10	216
HOND-16D	156, 215	HU-MNP	307	HY-11DP1	217, 226
HOND-16DP	156, 215	HU-NAAC2	354, 357, 358	HY-11DP3	217, 218, 226
HOND-17P	156	HU-NW	151	HY-11P3	217, 218, 226
HOND-18DP	327	HU-P	151	HY-11P4C1	217
HOND-19	328	HU-SC	169, 177, 195, 248, 255, 271, 285, 291, 307, 313	HY-12P3	226
HOND-19D	328			HY-18PIC1	226
HOND-19DP	328			HY-19DP5	217
HOND-19P	328	HU-SR	169, 177, 195, 248, 255, 271, 285, 291, 307, 313	HY-19P5	217
HOND-20	328			HY-20P	217
HOND-20D	328			I-1G	457
HOND-20DP	328	HU-SU	169, 177, 195, 248, 255, 271, 285, 291, 307, 313	I-1G NIQ	457
HOND-20P	328			IB-1	58
HOND-22D	328			IB-2	58
HOND-23	328	HU-SX	169, 177, 195, 248, 255, 271, 285, 291, 307, 313	ICA-1	58
HOND-24DP	328			ICA-4IP	58
HOND-24P	328			ICA-5IP	58
HOND-25P2	327	HU-SY	169, 177, 195, 248, 255, 271, 285, 291, 307, 313	ICS-1D	58
HOND-26DP1	328			ICS-2D	58
HOND-26P1	328	HU-SZ	169, 177, 195, 248, 255, 271, 285, 291, 307, 313	IDM-1G	428
HOND-27D	328			IDM-2G	428
HOND-28DP	328			IDM-3G	428
HOND-28P	328	HUD-1	213, 221, 225, 233, 291, 297, 298, 303, 315, 351	IDM-4G	428
HOND-29DP	328			IDM-5G	428
HOND-29P	328			IDM-5G	428
HOND-30DP2	327	HUD-1D	213, 221, 225, 233, 291, 297, 298, 303, 315, 351	IF-1I	58
HOND-30P2	327			IF-2	132
HOND-31P	328			IF-3P	58
HOND-42P	328			IF-4	132
HOND-43	328	HUD-2	57	IF-5	58
				IF-6	132

REF.	PAG.	REF.	PAG.	REF.	PAG.
IF-7	58	IMS-21P	323, 324, 331, 334, 335	IMS-7	230, 269, 274
IF-8	132	IMS-3	151, 159, 166, 180, 183, 184, 187, 189, 190, 191, 193, 226, 228, 234, 246, 256, 269, 271, 282, 294, 296, 301, 309, 323, 324, 331, 334, 335, 347	IMS-7P	230, 269, 274
IF-9	132	IMS-3P	151, 159, 166, 180, 183, 184, 187, 189, 190, 191, 193, 226, 228, 234, 247, 256, 269, 271, 282, 294, 296, 301, 309, 323, 324, 331, 334, 335, 348	IN-1	162, 169, 223, 230, 239, 265, 291, 348
IF-10D	58	IMS-5	151, 159, 166, 180, 183, 184, 187, 189, 190, 191, 193, 226, 228, 234, 246, 256, 269, 271, 282, 294, 296, 301, 309, 323, 324, 331, 334, 335, 347	IN-4	162, 169, 223, 230, 239, 265, 291, 348
IF-15	58	IMS-5P	151, 159, 166, 180, 183, 184, 187, 189, 190, 191, 193, 226, 228, 234, 247, 256, 269, 271, 282, 294, 296, 301, 309, 323, 324, 331, 334, 335, 348	IN-5	162, 169, 223, 230, 239, 265, 291, 348
IF-35	59	IMS-7	230, 269, 274	INCE-1E	146
IF-45/55	59	IMS-7P	230, 269, 274	INCE-2E	146
IF-60/70	59	IN-1	162, 169, 223, 230, 239, 265, 291, 348	ING-6	61
IF-D20	58	IN-4	162, 169, 223, 230, 239, 265, 291, 348	ING-A	61
IF-D25	59	IMS-13	323, 324, 331, 334, 335	ING-D	61
IF-D30	59	IMS-13P	151, 159, 183, 184, 187, 189, 190, 191, 193, 226, 228, 247, 256, 269, 271, 282, 294	ING-M	61
IF-I20	58	IMS-13P	323, 324, 331, 334, 335	ING-N	61
IF-I25	59	IMS-13P	348	ING-S	61
IF-I30	59	IMS-19	323, 324, 331, 334, 335	ING-W	61
IF-I40	59	IMS-19P	323, 324, 331, 334, 335	INH-ID	132
IF-I40L	59	IMS-21	323, 324, 331, 334, 335	INT-1	61
IF-I50	59	IMS-21	323, 324, 331, 334, 335	INT-ID	61
IF-I51	59			IR-IP	132
IF-I60/70	59			IS-1D	62
IGS-1	59				
IL-1D	61				
IL-1I	61				
IL-2	61				
ILC-1D	61				
ILC-2D	61				
ILC-3	61				
ILC-6D	61				
ILL-1	61				
ILL-2	61				
ILL-2D	61				
ILS-1	61				
IMB-1	61				
IMB-ID	61				
IMS-10	274				
IMS-11P	275				
IMS-12	187, 190, 193, 247, 269				
IMS-13	151, 159, 166, 180, 183, 184, 187, 189, 190, 191, 193, 226, 228, 246, 256, 269, 271, 282, 294				
IMS-13P	323, 324, 331, 334, 335				
IMS-13P	347				
IMS-13P	151, 159, 183, 184, 187, 189, 190, 191, 193, 226, 228, 247, 256, 269, 271, 282, 294				
IMS-13P	301				
IMS-13P	323, 324, 331, 334, 335				
IMS-13P	348				
IMS-19	323, 324, 331, 334, 335				
IMS-19P	323, 324, 331, 334, 335				
IMS-21	323, 324, 331, 334, 335				
IMS-21	323, 324, 331, 334, 335				
IMS-21P	323, 324, 331, 334, 335				

REF.	PAG.	REF.	PAG.	REF.	PAG.
IS-1G	428	JAR-2D	62	JTF-4	64
IS-1I	62	JAR-2I	62	JU-1	64
IS-1X	305	JAR-3	62	JU-2	65
IS-2D	62	JAR-4D	63	JU-2D	65
IS-2I	62	JAR-5D	63	JUNI-2	64
IS-3D	62	JAR-5I	63	JUNI-1	64
IS-3D	62	JAR-6	62	JUNI-ID	64
IS-3D	62	JAR-6D	62	JUNI-2D	64
IS-3G	428	JAU-1P	178, 223	JUNI-3D	64
IS-3I	62	JD-1	351	JUNI-4D	64
IS-4	62	JD-2	324, 351	JUNI-5D	64
IS-4G	429	JD-3	351	JUNI-6D	64
IS-5D	62	JD-4D	351	JUNI-7D	64
IS-5G	429	JF-ID	133	JUNI-8D	64
IS-6D	132	JGH-1D	64	JUNI-9D	64
IS-6G	429	JIN-ID	63	JUZU-1	65
IS-7D	62	JIP-ID	63	JV-1D	65
IS-8	62	JIP-1I	63	JV-1I	65
IS-8D	62	JIS-1D	63	JV-2	65
IS-10	133	JIS-2I	63	JV-3D	65
IS-10P	133	JIS-3D	63	JV-3I	65
IS-14D	133	JIS-3I	63	JV-4I	65
IS-15	62	JIS-4P	63	JV-5I	65
IS-16D	62	JMA-1D	112	JV-6	65
IS-17D	62	JMA-1I	112	JV-7	65
IS-18D	62	JMA-2D	112	JV-7D	65
IS-19D	62	JMA-2I	112	JW-20G	429
IS-20	133	JMA-3D	112	JW-30G	429
IS-21D	62	JMA-3I	112	JW-40G	430
IS-22D/1	133	JMA-4D	112	JW-45G	430
IS-22D/2	133	JMA-4I	112	JW-50G	430
IS-22D/3	133	JMA-9D	112	JW-70G	430
IS-22D/4	133	JMA-9I	112	JW-90G	430
IS-22D/5	133	JNG-1	64	JWL-1D	63
IS-23DP	133	JNG-1D	64	JWL-2D	63
IS-24DP	133	JNG-2D	64	JWL-3D	63
ISU-1	305	JNG-3	64	JWL-4D	63
ISU-2	304	JO-1	63	JWL-5	63
ISU-2	305	JOM-1D	63	JWL-6	63
ISU-3D	222	JP-1	407	JWL-7D	63
ISU-3DP	222	JP-2	407	JWL-9	63
ISU-3DP1	222	JP-3	407	JWL-9D	63
ISU-5	62	JP-4	407	JWL-10D	64
IT-1G	429	JP-5	407	JWL-11D	64
IT-ITG	429	JP-6	407	KA-1	133
IT-2G	429	JPM-1D	64	KA-2	133
IT-3G	429	JPM-1E	64	KA-3	133
IT-4G	429	JPM-1I	64	KA-4	133
ITO-ID	62	JPM-2D	64	KA-5	133
ITO-2D	133	JPM-2E	64	KA-6	134
ITO-3D	133	JPM-2I	64	KA-7	133
IV-1	62	JPM-3D	64	KA-7	134
IV-2D	62	JPM-4	64	KA-7	134
IV-3D	62	JPM-4D	64	WINDCOLOR	
J-1G(CV)	458	JPM-10D	64	KA-8	134
J-2G(CV)	458	JPM-11D	64	KA-10	134
J-3G	458	JTF-1I	64	KA-11	134
J-3G(CV)	458	JTF-2I	64	KAB-1D	65
JAR-1D	62	JTF-3	64	KAE-1	134
JAR-1I	62			KAE-1G	430
JAR-1I	62			KAE-2	134

REF.	PAG.	REF.	PAG.	REF.	PAG.
KAE-3	65	KEN-1	66, 221, 225, 226, 233, 348, 351	KRCDAE-4D	360, 365, 366
KAE-3D	65	KEN-1D	66, 221, 225, 226, 233, 348, 351	KRCDAE-4D	360, 365, 366
KAE-4	134	KFV-1	66	KRCDAT-15	363, 365
KAE-5	65	KFV-1X	304	KRCFO-6	361, 363
KAE-6	65	KFV-2	66	KRCFO-15D	361, 364
KAE-6D	65	KFV-2X	304		
KAE-7	65	KFV-3X	305		
KAE-7D	65	KFV-C	66		
KAE-8	65	KFV-D	66		
KAE-8D	65	KFV-E	66		
KAE-9	65	KFV-F	66		
KAE-9D	65	KFV-L	66		
KAE-10D	134	KFV-M	66		
KAE-11D	134	KFV-N	66		
KAE-12D	134	KFV-O	66		
KAE-13D	65	KI-1D	198, 226		
KAE-14	134	KI-IDP	198, 226		
KAE-15D	134	KI-IDPI	226		
KAL-1	65	KI-2D	226		
KAL-2D	65	KI-3DP	226		
KAM-1	151	KI-3P	226		
KAM-1D	151	KI-11P	226		
KAP-1D	65	KI-12DP	226		
KAP-2D	65	KI-12P	226		

Índice de referencias
Erreferentzia aurkibidea
Index des références

Referenzverzeichnis
Índice de referências
Spis modeli

REF.	PAG.	REF.	PAG.	REF.	PAG.	REF.	PAG.	REF.	PAG.	REF.	PAG.	REF.	PAG.	REF.	PAG.	REF.	PAG.		
KRCFO-16	361, 364	LAP-1	67	LAS-AX	151	LF-9	265, 296	LF-WB	281	LIT-3D	70	MAS-2D	74	MAZ-13D	236	ME-2P	237	MER-8I	77
KRCFO-24	361, 362, 364	LAP-2D	67	LAS-AX-L	69	LF-10	72	LF-WBP	281	LIT-5D	70	MAS-3D	75	MAZ-13DP	236	ME-3P	237	MER-9I	77
KRCFO-30D	362, 362, 364	LAP-2E	67	LAS-BT	276	LF-11D	72	LF-WR	178, 195, 223, 303	LIT-5I	70	MAS-4D	75	MAZ-13DP1	236	ME-4P	237	MER-10I	77
KRCGM-27	360, 365, 366	LAP-3	407	LAS-CR	276	LF-12	319, 339			LIT-7D	70	MAS-5D	75	MAZ-14D	236	ME-5P	237	MER-11I	77
KRCGM-28	360, 365	LAP-3D	67	LAS-FH	348	LF-12	72	LIN-1D	69	LMP-1	183, 250, 257	MAS-6	75	MAZ-14D	303	ME-6P	237	MER-12I	77
KRCGM-37	360, 362, 366	LAP-3E	67	LAS-KT	68, 348	LF-12D	319, 339	LIN-1I	69	LMP-1P	183, 250, 257	MAS-7	75	MAZ-15D	236	ME-7P	237	MER-13I	77
KRCGM-43	366	LAP-3I	67	LAS-P	173	LF-13	72	LIN-2	69	LMP-2	250, 250, 257	MAS-7D	75	MAZ-16	236	ME-8P	237	MER-14I	77
KRCHOND-21	362	LAP-4	135	LAS-R	69, 173, 250, 262, 297, 302, 306, 311, 312, 314, 342	LF-13D	72	LIN-2G	431	LMP-2P	250, 257	MAS-8	75	MAZ-21DP1	236	ME-9P	307	MER-15	78
KRCHOND-31	360, 362	LAP-5D	67			LF-14D	72	LIN-3D	69	LMP-3	250, 258, 276	MAS-9	75	MAZ-21DP1	80	ME-10P	237	MER-16	78, 321
KRCHU-HAA	360, 365, 366, 367	LAP-6	67	LAS-RC	276	LF-15	72	LIN-3G	431	LMP-3P	311	MAS-9D	75	MBL-1D	80	ME-11P	237	MER-16D	78, 321
KRCHU-HCA	361, 363, 365, 367	LAP-7D	67	LAS-SX	69	LF-15D	348	LIN-3I	69	LMP-3P	250, 276	MAS-10	75	MBL-1G	408	ME-12P	237	MER-17	78
KRCHY-4	362, 363	LAP-8D	135	LAS-TB	276	LF-16	72	LIN-4D	69	LMP-4	250, 258, 276	MAS-10D	75	MCH-1	78	ME-13DP	308	MER-18	78
KRCHY-6D	362	LAP-9	67	LAS-TK	68, 348	LF-17	72	LIN-4I	69	LMP-4	311	MAS-11	75	MCH-1D	78	ME-14P	308	MER-19D	78
KRCHY-11	362, 363	LAP-9D	67	LAS-TX	69	LF-17	72	LIN-5D	69	LMP-4P	250, 276	MAS-11D	75	MCH-2	78	ME-HD	237, 271	MER-20D	78
KRCHY-11D	363	LAP-10D	135	LAS-UY	69	LF-17	348	LIN-5I	69	LMP-4P1	258	MAS-12D	75	MCH-2D	78	ME-HDP	237, 272	MER-21D	78
KRCISU-3D	361, 362, 363	LAP-11D	135	LAS-U	68, 151, 335, 348	LF-18D	72	LIN-6D	69	LMP-4P1	311	MAS-13D	75	MCL-1D	76	ME-HDP	308	MER-22D	78
KRCKI-7	362, 363	LAP-13P	135	LAS-V	69, 173, 250, 262, 297, 302, 306, 311, 312, 314, 342	LF-19	72	LIN-6I	69	LMP-5	250, 258, 262, 276	MAS-15P	136	MCM-1	76	ME-HF	237, 271	MER-1D	151, 351
KRCMAZ-11D	364	LAP-17P	135			LF-20	73	LIN-7D	69	LMP-5	311	MAS-17	75	MCM-1G	408	ME-HFP	237, 272	MER-IDP	151, 351
KRCME-7	367	LAP-20P	135	LAS-X	151, 335, 348	LF-20D	73	LIN-7I	69	LMP-5P	250, 276	MAS-17D	75	MCM-2D	76	ME-HM	237, 271	MER-IDP1	152
KRCMIT-8D	364, 365	LAP-21P	135	LAS-XY	69	LF-21	73	LIN-8D	69	LMP-5P1	258, 262	MAS-18D	75	MCM-2G	431	ME-HMLP	237	MER-IDP1	152
KRCMIT-12	364	LAP-22P	135	LAS-Y	69, 173, 250, 262, 297, 302, 306, 311, 312, 314, 342	LF-22	73	LIN-8I	69	LMP-5P1	311	MAS-19	75	MCM-2I	76	ME-HMLP	308	MER-2DP	151, 351
KRCMIT-18	365	LAP-23P	135			LF-23	73	LIN-9	69	LMP-5P1	311	MAS-22D	74	MCM-3D	76	ME-HMP	237, 272	MET-2D	78
KRCNE-36	366	LAP-28D	67	LASB-1	69	LF-24	73	LIN-10D	70	LO-1D	71	MAS-24D	74	MCM-3G	431	ME-HMP	308	MEZ-1D	78
KRCOP-11	360, 361, 362, 365	LAP-29D	67	LASB-1D	69	LF-25	73	LIN-10I	70	LO-1I	71	MAS-29D	75	MCM-3I	76	ME-HU	238	MG-6D	32
KRCOP-S	362, 365	LAP-30D	67	LASB-1D	69	LF-26	73	LIN-11D	70	LO-2D	72	MAS-42	136	MCM-4D	76	ME-HUP	238	MG-6I	32
KRCSUB-2	366	LAP-34D	67	LASB-1G	408	LF-27	73	LIN-11I	70	LO-2I	72	MASL-1	136	MCM-4EC	76	ME-HY	238	MG-6S	32
KRCSUZU-14	366	LAP-42D	67	LASB-2	69	LF-28	73	LIN-12D	69	LO-3D	71	MAU-1	136	MCM-4G	408	ME-HYP	238	MG-9	32
KRCUOYO-15	367	LAP-43D	67	LASB-2D	69	LF-29D	73	LIN-12I	69	LO-4D	72	MAU-2	136	MCM-4I	76	ME-HZ	237, 271	MGA-1	78
KRCUOYO-18	363	LAP-44D	67	LASB-2D	69	LF-30	73	LIN-13	135	LOC-1D	71	MAU-3D	75	MCM-4SS	136	ME-HZP	237	MGA-1D	78
KRCUOYO-30	363	LAP-45D	67	LASB-2G	408	LF-31	73	LIN-14D	69	LPO-1	68	MAU-4D	75	MCM-5D	76	ME-HZP	272	MGA-2	136
KRE-ID	67	LAP-46D	67	LASB-3D	69	LF-32	195	LIN-14I	69	LPO-2	68	MAU-5D	75	MCM-5G	432	ME-HZP	308	MGA-3	136
KRP-1G	431	LAP-53	68	LASB-3G	408	LF-32	72	LIN-15D	69	LT-1	135	MAX-1G	448	MCM-5I	76	ME-L	238	MH-1	137
KUB-ID	351	LAP-57	68	LASB-4G	408	LF-32	348	LIN-15I	69	LUC-1D	74	MAX-2G	448	MCM-6	76	ME-L	308	MH-2D	137
KUB-2D	351	LAP-71	68	LB-1	71	LF-33D	73	LIN-16	70	LUC-2	74	MAZ-1D	234	MCM-7	76	ME-NU	238	MI-ID	78
KUR-1G	431	LAP-88	68	LB-1D	71	LF-34	73	LIN-16D	70	LUMA-1D	74, 348	MAZ-1D	303	MCM-8	76	ME-NUP	238	MI-2D	79
KWI-1	67	LAP-93	68	LB-2D	71	LF-35	73	LIN-17	69	LUMA-1I	74, 348	MAZ-1I	234	MCM-10	136	ME-NY	238	MI-3D	79
KWI-1K	67	LAP-96D	68	LB-2DP	71	LF-36	73	LIN-17D	69	LUMA-2D	74, 348	MAZ-1I	303	MCM-11S	136	ME-NYP	238	MI-4D	79
KWI-2D	67	LAP-98	68	LB-2MD	71	LF-37D	74	LIN-18	69	LUMA-2I	74, 348	MAZ-2D	199, 234	MCM-12D	76	ME-S	302, 308	MI-5D	79
KYM-1DP	331	LAP-100	408	LB-3	71	LF-38D	74	LIN-18D	69	LUMA-3D	74, 348	MAZ-2DP	199, 235	MCM-13D	76	ME-SP	302	MIL-1	79
KYM-1P	331	LAR-1G	408	LB-3D	71	LF-40	73	LIN-19D	135	LUMA-3I	74, 348	MAZ-2I	199, 234	MCM-15E8	136	ME-VA	212, 238, 314	MIL-1	460
KYM-2	331	LAR-1I	68	LB-4D	71	LF-41	74	LIN-20D	69	LUMA-4D	74, 348	MAZ-2IP	199, 235	MCM-16E8	136	MEC-5D	77	MIL-2	79
KYM-2D	331	LAR-2G	444	LB-5D	71	LF-43	73	LIN-21D	135	LUMA-4I	74, 348	MAZ-3D	235	MCM-18D	76	MEC-6	77	MIL-2	460
KYM-2DP	331	LAR-3G	445	LB-6D	71	LF-44	74	LIN-21D WINDCOLOR	135	LWO-1	71	MAZ-3DP	235	MCM-21D	136	MED-1D	77	MIIN-1D	79
KYM-2P	331	SAS-1D	68, 151	LCK-1X	306	LF-45	74	LIN-25	70	LWO-1D	71	MAZ-3I	235	MCM-24B	76	MED-2D	77	MIS-1	79
KYM-3DP	331	SAS-2	68, 348	LEA-1D	69	LF-46	74	LIN-25D	70	LWO-2	71	MAZ-3IP	235	MCM-24C	76	MEG-1D	136	MIT-ID	171, 181, 213, 222, 240, 303, 305, 350, 351
KYM-3P	331	SAS-3	151, 335, 348	LEA-2D	69	LF-47	72	LIN-25D WINDCOLOR	70	LWO-2D	71	MAZ-4	235	MCM-24D	76	MEL-1	77		
L-3G	458	SAS-4	348	LEG-1D	69	LF-47	348	LIN-26D	135	LWO-7D	71	MAZ-4P	235	MCM-24E	76	MEL-2D	77		
L-3G(CV)	458	SAS-4D	68	LF-1	72	LF-50D	74	LIP-1D	70	LWO-8	71	MAZ-5D	235	MCM-24F	76	MEL-3	77	MIT-IDP	171, 213, 240, 303, 305, 350, 351
LA-1D	227	LAS-4D	68	LF-1D	72, 348	LF-51	74	LIP-1GD	70	LWO-9	71	MAZ-5DP	235	MCM-26	76	MEL-4	77		
LA-1DP	227	LAS-5	151, 335, 348	LF-1I	348	LF-BL	164, 220, 265	LIP-1GD	70	LWO-26D	71	MAZ-6	202, 235	MCM-27	136	MEL-4D	77		
LA-2	227	LAS-5D	151, 335, 348	LF-2	72, 319, 339	LF-RO	164, 169, 220, 230, 232, 234, 247, 265, 282, 296, 301	LIP-1I	70	LYF-2T	146	MAZ-6D	202	MCM-29D	76	MEL-5P	77	MIT-II	171, 181, 213, 222, 240, 303, 305, 350, 351
LA-2P	227	LAS-6	68, 348	LF-3	72			LIP-2	70	MAC-1G	448	MAZ-6DP	202, 235	MCM-30D	77	MER-1D	77		
LA-3D	227, 241	LAS-6D	68, 348	LF-4I	72			LIP-2D	70	MAF-1	408	MAZ-6P	202, 235	MCM-31	77	MER-1T	146	MIT-IIP	171, 213, 222, 240, 303, 305, 350, 351
LA-3DP	227, 242	LAS-7	68	LF-5	72, 195, 348			LIP-3	70	MAG-2DP	135	MAZ-7D	235	MCM-31D	77	MER-2I	77		
LA-4D	227	LAS-8	68	LF-5D	195, 348			LIP-3	70	MAK-1	306	MAZ-7DP	235	MCM-32D	77	MER-3I	77		
LA-4DP	227	LAS-9	68	LF-6	171, 181, 282, 296, 302			LIP-28D	70	MAR-1P	233	MAZ-7DP1	235	MCM-33	77	MER-3T	146	MIT-2D	171, 206, 217, 222, 240, 275, 278, 304, 308, 350, 351
LAF-1D	67	LAS-10	68					LIP-33	70	MAS-1	74	MAZ-8D	235	MCM-35	77	MER-4I	77		
		LAS-11	68	LF-7	72			LIP-4	70	LIT-1I	74	MAZ-8DP	235	MCM-45	136	MER-5I	77		
		LAS-11D	68	LF-7D	72			LIT-2D	70	LIT-2D	74	MAZ-11D	235	ME-1	236	MER-6I	77		
		LAS-12D	68	LF-8D	72					MAS-ID	74	MAZ-11DP1	236	ME-1P	237	MER-7I	77		

Índice de referencias
Erreferentzia aurkibidea
Index des références

Referenzverzeichnis
Índice de referências
Spis modeli

REF.	PAG.	REF.	PAG.	REF.	PAG.	REF.	PAG.	REF.	PAG.	REF.	PAG.	REF.	PAG.	REF.	PAG.	REF.	PAG.	REF.	PAG.		
MIT-2DP	171, 217, 222, 240, 278, 304, 308, 350, 351	MOR-1X	307	MTL-1D	78	NE-4P	155, 174, 190, 250, 253, 258, 261, 263	NE-15IP1	162, 174, 251, 258, 261, 263	NE-42P	254	OJ-11	82	OP-R	208, 221, 249, 283	PFA-4	84	PPT-3G	409		
MIT-2I	171, 206, 217, 222, 240, 275, 278, 304, 308, 350, 351	MOR-2X	307	MTL-1G	432	NE-4P1	162, 174, 251, 258, 261, 263	NE-16	160, 258, 261	NE-42P1	254	OJ-12	82	OP-RP	208, 221, 249, 283	PFA-5	84	PR-1	85		
MIT-2IP	171, 217, 222, 240, 278, 304, 308, 350, 351	MOS-1	242	MTL-2G	432	NE-4P2	174, 251, 258, 261, 263	NE-18	292	NE-43	254, 262	OJ-13	82	OP-S	177, 207, 212, 213, 232, 248, 283	PFA-6	85	PR-1D	85		
MIT-3	240, 248	MP-1D	80	MTO-1	78	NE-5	258	NE-18P	292	NE-44P	152, 276	OJ-14	82	OP-SP	177, 202, 208, 212, 213, 232, 248, 283	PFA-6D	85	PR-1G	436		
MIT-3P	240, 248	MP-1I	80	MU-2P1	137	NE-6	310, 317, 319, 320, 322, 323, 324, 325, 326, 329, 330, 331, 332, 334, 335, 336, 337, 339, 341, 342	NE-19	160, 182, 251, 259, 263, 311	NE-45P	337	OJ-15	82	OP-T	208, 221, 249, 283	PFA-7D	85	PR-2	85		
MIT-4	241	MPA-1G	409	MU-3P1	137	NE-6P	310, 317, 319, 320, 322, 323, 324, 325, 326, 329, 330, 331, 332, 334, 335, 336, 337, 339, 341, 342	NE-19P	160, 182, 259, 263, 311	NE-46	190	OJ-16	82	OP-TP	208, 221, 249, 283	PFA-8D	85	PR-2G	448		
MIT-4P	241	MQ-1D	74, 348	MU-4P1	137	NE-7	320	NE-20	251, 253	NE-47	188	OJ-17	82	OP-WHCl	354, 356	PFA-9D	85	PR-3	85		
MIT-5	241	MQ-1I	74, 348	MU-5P1	137	NE-8	317, 318, 319, 321, 322, 323, 324, 325, 329, 326, 332, 333, 334, 335, 336, 337, 338, 339, 340, 343	NE-20P	161, 251, 259, 263	NE-48	152	OJ-18P	82	OP-WHP	162, 202, 208, 213, 221, 249, 283	PFA-10D	84	PR-3G	436		
MIT-5P	241	MR-1	80	MU-6D	81	NE-9	291, 314	NE-20P2	161, 251, 259, 263	NE-49	152	OJ-19	82	OP-WYP	162, 202, 208, 213, 221, 249, 283	PFA-11D	84	PR-4D	85		
MIT-6	241	MR-2	80	MU-7P1	137	NE-10	179, 239, 292, 296	NE-22P	161, 259, 261, 263, 298, 309, 311	NE-50P	260	OL-5D	82	OR-0G	445	PFA-12D	84	PR-4G	437		
MIT-6P	241	MR-3	80	MU-8P1	137	NE-11	195, 230, 245, 265, 270, 298, 303, 305, 312	NE-22P1	161, 174, 251, 310	NE-51P2	252	OLIV-1	82	OR-1G	445	PFA-13D	84	PR-4I	85		
MIT-7	167, 180, 181, 241	MSM-1D	137	MU-9P1	137	NE-12	292, 314	NE-22P2	161, 236, 276, 298	NE-52P	231, 266	OM-1	83	OR-2G	435	PFA-14D	84	PR-5D	85		
MIT-7P	167, 180, 182, 241, 305	MSM-2D	80	MU-10P	137	NE-13	292, 314	NE-23	236	NE-53	190, 254, 262	OMC-1D	82	OR-3G	409	PFA-15D	84	PR-5I	85		
MIT-8D	172, 181, 182, 241	MSV-1	81	MU-11P1	137	NE-14	266	NE-24	196, 230, 266, 270	NE-54P	153	OMC-1G	435	OR-4G	445	PFA-16D	84	PR-6	85		
MIT-8DP	172, 181, 182, 241	MSV-1X	307	MU-16P	137	NE-15D	155, 162, 173, 189, 250, 253, 258, 261, 263	NE-24P	196, 230, 266, 270	NE-55P	260, 262	OMC-2D	83	OR-5G	445	PFA-17D	84	PR-7	85		
MIT-8DP2	241	MSV-2	81	NAB-1X	307	NE-15DP	155, 174, 190, 250, 253, 258, 261, 263	NE-25	159, 185, 313	NE-56	292, 331	OMC-3	137	OR-6G	409	PFA-18D	84	PR-8	85		
MIT-9	308	MT-1G	432	NE-1	152, 164, 215, 239, 265, 296, 301, 314, 351	NE-16P	161, 174, 251, 259, 261, 263	NE-26	236	NE-57	153	OMC-4	137	OR-7G	445	PFA-21	85	PR-9	85		
MIT-10	308	MT-2D	137	NE-1D	152, 164, 215, 239, 265, 296, 301, 351	NE-17	152	NE-27	152	NE-58D	272, 352	OMC-5D	83	OR-8G	445	PFA-22	84	PR-9D	85		
MIT-11D	308	MT-2DP	137	NE-1DIP	152, 164, 215, 239, 265, 296, 301, 351	NE-18	182, 259, 261, 263, 311	NE-28	182, 259, 261, 263, 311	NE-59P	161, 260, 262	OMC-6D	83	OR-9G	445	PFA-22D	84	PR-10	85		
MIT-12	167, 181, 182, 241	MT-2G	432	NE-1IP	152, 164, 215, 239, 265, 296, 301, 351	NE-19	251	NE-29	251	NE-60C1	356, 358	OMC-7	137	OR-1I	83	PFA-23D	84	PR-11	85		
MIT-13D	181, 182, 241, 255	MT-2TG	433	NE-2	152	NE-20P	161, 251, 259, 263	NE-29P	251	NE-60C2	356, 357	OMI-1	83	OR-2G	435	PFA-24D	85	PR-12	85		
MIT-14D	181, 182, 241, 255	MT-3G	433	NE-3	183, 187, 189, 227, 242, 253, 258, 261, 276, 283, 294, 297, 311, 314	NE-21	159, 185, 313	NE-30	152, 348	NE-60C3	356, 357	OMI-ID	83	OR-3G	409	PFA-25	85	PR-13	85		
MIT-15P	167, 180, 182, 241, 305	MT-3PG	433	NE-3D	183, 187, 189, 227, 242, 253, 258, 261, 276, 283, 294, 197, 311, 314	NE-22	161, 259, 261, 263, 298, 309, 311	NE-30P	152, 348	NE-61D	238	ON-ID	83	OR-4G	445	PFA-25D	85	PR-14	85		
MIW-1	79	MT-4G	433	NE-3P	183, 188, 189, 227, 242, 253, 261, 283, 295, 297, 311, 314	NE-23	236	NE-31	152, 348	NE-62	238	ON-I	83	OR-5G	445	PFA-26D	85	PR-15D	85		
MIW-2	79	MT-5G	433	NE-3P1	183, 227, 242, 258, 276, 295, 298, 311	NE-24	196, 230, 245, 265, 270, 298, 303, 305, 312	NE-31P	152, 348	NE-63D	153	OP-1	153	OR-6G	409	PFA-27D	85	PR-16D	85		
MIW-3	79	MT-6G	433	NE-3P2	183, 188, 189, 227, 242, 253, 258, 261, 276, 283, 295, 298, 311, 314	NE-25	159, 185, 313	NE-32	152, 348, 346	NEF-1X	307	OP-6	176, 248	OR-7G	445	PGO-1	338	PR-17D	86		
MIW-4	79	MT-6PG	434	NE-4	155, 162, 173, 189, 250, 253, 258, 261, 263	NE-26	236	NE-32P	152, 346	NEF-2Z1	453	OP-7	176, 248	OR-8G	445	PGO-2P	338	PR-18	86		
MLM-1D	79	MT-8G	434	NE-4D	155, 162, 173, 189, 250, 253, 258, 261, 263	NE-27	152	NE-33P	152, 276	NEF-2Z2	453	OP-8	176, 248	OR-9G	445	PHI-52	85	PR-19	85		
MLM-2	79	MT-8PIG	434	NE-5	183, 187, 189, 227, 242, 253, 258, 261, 276, 283, 294, 297, 311, 314	NE-28	182, 259, 261, 263, 311	NE-34P	251	NEF-2Z3	453	OP-9	176, 248	OR-1I	83	PHO-1	85	PR-20	85		
MLM-3	79	MT-8PG	434	NE-6	195, 230, 245, 265, 270, 298, 303, 305, 312	NE-29	251	NE-35P	266	NEF-2Z4	453	OP-11C1	354, 355, 356	OR-2G	435	PIC-8D	138	PR-20D	85		
MLM-4	137	MT-9G	434	NE-7	320	NE-30	152, 348	NE-35P2	215, 266	NEF-2Z5	453	OP-11C3	356	OR-3G	409	PJ-1	177, 264, 277, 285, 288, 290, 312	PR-21	138		
MLM-5	79	MT-9PG	434	NE-8	317, 318, 319, 321, 322, 323, 324, 325, 329, 330, 331, 332, 334, 335, 336, 337, 338, 339, 340, 343	NE-31	152, 348	NE-36	161, 174, 251, 259, 261, 263	NEF-2Z6	453	OP-AB	176, 213, 248, 282	OR-4G	445	PJ-2	174, 183, 264, 266, 274, 277, 285, 288, 290, 312	PR-22	138		
MLM-5D	79	MT-9PIG	434	NE-9	291, 314	NE-32	152, 348, 346	NE-36P	161, 174, 251, 259, 264	NEF-2Z7	453	OP-ABP	177, 213, 248, 283	OR-5G	445	PRE-1I	301, 306, 352	PRE-2I	153		
MLM-6	80	MT-10G	433	NE-10	179, 239, 292, 296	NE-33P	152, 346	NE-37	252	NEF-2Z8	453	OP-BA	176, 213, 248, 282	OR-6G	409	PRE-3	301, 306, 352	PRE-3	301, 306, 352		
MLM-7	80	MT-10PG	434	NE-11	195, 230, 245, 265, 270, 298, 303, 305, 312	NE-34P	251	NE-38	259	NEF-2Z9	453	OP-BAP	177, 213, 248, 283	OR-7G	445	PTN-1D	138	PTN-1D	138		
MLM-8	137	MT-11G	434	NE-12	292, 314	NE-35P	266	NE-39P	161, 174, 252, 259, 264	NEF-3	81	OP-BB	153, 170, 177, 248	OR-8G	445	PJ-1	177, 264, 277, 285, 288, 290, 312	PRE-1I	301, 306, 352	PTN-1G	435
MLM-9	79	MT-14G	434	NE-13	292, 314	NE-36P	161, 174, 251, 259, 264	NE-40	292	NEF-4	81	OP-CC	153, 170, 177, 248	OR-9G	445	PJ-2	174, 183, 264, 266, 274, 277, 285, 288, 290, 312	PRE-2I	153	PTN-2D	138
MM-1X	307	MT-15G	434	NE-14	266	NE-41P	292	NE-40P	292	NO-1	137	OP-D	177, 207, 212, 213, 232, 248, 283	OR-1I	83	PJ-2P	174, 183, 264, 266, 274, 277, 285, 288, 290, 312	PRE-3	301, 306, 352	PTN-2G	435
MNO-1D	80	MT-16G	434	NE-15D	155, 162, 173, 189, 250, 253, 258, 261, 263	NE-42	254	NE-41P	292	NOX-1	81	OP-DD	153, 170, 177, 248	OR-2G	435	PJ-3	277	PTN-3D	138	PTN-3D	138
MOD-1DP	152	MT-17PIG	434	NE-15DP	155, 174, 190, 250, 253, 258, 261, 263	NE-42P	254	NE-42P1	254	NTC-6	81	OP-DP	177, 202, 208, 212, 213, 232, 248, 283	OR-3G	409	PJ-K	174, 220, 252, 266, 277	PTN-4D	138	PTN-4D	138
MOG-1D	80	MT-17PG	435	NE-15DP1	162, 174, 251, 258, 261, 263	NE-43	254, 262	NE-43P	254	OA-1	82	OP-EE	153, 170, 177, 248	OR-4G	445	PJ-KP	174, 220, 252, 266, 277	PTN-5G	435	PTN-5G	435
MOI-1G	432	MT-18G	435	NE-15I	155, 162, 173, 189, 250, 253, 258, 261, 263	NE-44P	152, 276	NE-44P1	152, 276	OCA-1D	81	OP-FF	153, 170, 177, 248	OR-5G	445	PL-1	112	PTN-6G	436	PTN-6G	436
MOI-2G	432	MT-AG	80	NE-16P	161, 174, 251, 259, 261, 263	NE-45P	337	NE-45P1	337	OCA-2D	81	OP-HA	170, 248	OR-6G	409	PL-ID	112	PTN-7G	436	PTN-7G	436
MOI-3G	432	MT-AGP	80	NE-17	152	NE-46	190	NE-46P	190	OF-1	81	OP-HB	170, 248	OR-7G	445	PLL-1	352	PTN-8G	436	PTN-8G	436
MOI-4G	432, 448	MT-CG	80	NE-18	292	NE-47	188	NE-47P	188	OF-2	81	OP-HG	249	OR-8G	445	PO-2P	255	PTN-9G	436	PTN-9G	436
MOI-5G	432, 448	MT-CGP	80	NE-19	160, 182, 251, 259, 263, 311	NE-48	152	NE-48P	188	OJ-1D	81	OP-HH	249	OR-9G	445	PO-HC	255	PTN-10G	436	PTN-10G	436
MOK-1G	409	MT-EG	80	NE-20	251, 253	NE-49	152	NE-49P	152	OJ-2I	81	OP-J	177, 213, 249, 283	OR-1I	83	PO-HCP	255	PTN-11G	436	PTN-11G	436
MON-1D	80	MT-EGP	80	NE-21	159, 185, 313	NE-50P	260	NE-50P1	260	OJ-3D	81	OP-JP	177, 213, 249, 283	OR-2G	435	PO-NC	255	PTN-12G	436	PTN-12G	436
MON-1I	80	MT-EGP	80	NE-22	161, 259, 261, 263, 298, 309, 311	NE-51P2	252	NE-51P21	252	OJ-4D	81	OP-NA	170, 248	OR-3G	409	PO-NCP	255	PTN-13G	436	PTN-13G	436
MON-2D</																					

Índice de referencias
Erreferentzia aurkibidea
Index des références

Referenzverzeichnis
Índice de referências
Spis modeli

REF.	PAG.	REF.	PAG.	REF.	PAG.	REF.	PAG.	REF.	PAG.	REF.	PAG.	REF.	PAG.	REF.	PAG.	REF.	PAG.	REF.	PAG.
RE-4D	86	RO-7I	87	RO-46	88	RUS-2	89	SEL-4D	91	SKO-1	269	SPI-1D	138	STS-2D	183	SUZU-10P	213, 223, 275	TD-30	131
RE-5	86	RO-8D	87	ROD-1	87	SA-1	90	SEN-1D	91	SKO-2	269	SQ-1	94	STS-2DP	184	SUZU-11D	340	TD-31	50
RE-5D	86	RO-8I	87	ROD-1D	87	SA-1D	90	SEN-2D	91	SKO-3I	270	SQ-2	94	STS-3D	95	SUZU-11DP	340	TE-1D	97
RE-6	86	RO-9D	87	ROS-2	309	SA-2	90	SER-1G	449	SKO-3IP	270	SQ-3D	94	STS-3I	95	SUZU-12DP	330, 34	TE-1G	410
RE-6D	86	RO-9I	87	ROS-2	310	SA-3D	90	SER-3D	138	SKO-4	270	SQ-4	94	STS-4D	95	SUZU-12P	330, 34	TE-1I	97
REG-1D	86	RO-10D	87	ROSE-1	138	SA-3I	90	SH-1I	92	SKO-5P	270	SQ-5D	94	STS-4DP	95	SUZU-13DP	319, 321, 329, 330, 332, 336, 338, 340	TE-2G	410
REN-1G	409	RO-10I	87	ROY-1	88	SA-4	90	SHA-1	92	SKO-6	270	SQ-6	94	STS-5D	183			TE-3	97
REN-2G	409	RO-11D	87, 252, 260	RSS-1	89	SA-5D	90	SHI-1	92	SKO-7	270	SQ-7	94	STS-5DP	184			TE-3G	410
REVI-1G	437	RO-11I	87, 252, 260	RSS-2D	89	SAA-1PI	267	SHI-1D	92	SKO-8	270	SQ-8D	94	STS-6D	96	SUZU-13P	319, 321, 329, 330, 332, 336, 338, 340	TE-4	97
REX-1D	86	RO-12D	87	RSS-3	89	SAA-2P	267	SHI-2D	92	SL-1	91	SR-1I	96	STS-7D	96			TE-7D	97
REX-1G	409	RO-12I	87	RSS-3D	89	SAA-AC	267	SHI-3D	92	SLG-1	90	SR-2	96	STS-1I	339			TE-8D	97
REX-2G	410	RO-14	252	RST-1	20	SAA-ACP	267	SHR-1	90	SLG-2	90	SR-3	96	STS-12D	96	SUZU-14P2	275	TE-8DKT1	97
RGL-1G	437	RO-15	155, 162, 260, 264	RU-1	88	SABT-1	89	SI-1D	153	SLG-3	91	SR-4	96	STS-13D	96	SUZU-21P	275	TE-8I	97
RGM-1D	86			RU-1D	88	SAF-1G	438	SI-2D	153, 188, 190	SLG-4	91	SRM-1G	439	STS-21D	96	SUZU-21P	340	TE-8I	97
RGM-1I	86	RO-15	312	RU-1D	88	SAF-2G	438	SI-3	153, 188, 190	SLG-5	91	SSA-1P1	270	STS-28	95	SWL-1	92	TE-8I	97
RGM-2	86	RO-16D	87	RU-1D	88	SAG-1T	147	SI-3D	153, 188, 190	SLG-6	91	SSO-1	93	STS-35	138	WINDCOLOR		TE-9D	98
RI-1D	87	RO-16I	87	RU-2D	88	SAG-1T	147	SI-4	153	SLG-7	91	SSO-2	93	STS-38	138	TAI-1	96	TE-10I	98
RI-1I	87	RO-17	264	RU-2I	88	SAM-1D	89	SI-4D	153	SLG-8	91	ST-1I	95	STS-B1	139	TAL-1D	96	TE-11D	98
RI-2D	87	RO-17	312	RU-3D	88	SAM-1G	438	SIA-2G	439	SLG-9	91	ST-2	95	STS-T14	139	TAL-2	97	TE-23	98
RI-2I	87	RO-18I	87	RU-4D	88	SAM-2D	90	SIA-3G	439	SLG-10	91	STA-1	94	STS-T15	139	TAL-3	97	TE-28	98
RI-3D	87	RO-19D	87	RU-5D	89	SAM-2G	438	SIB-1G	449	SLG-11	91	STA-1D	94	STS-TV3	139	TAP-1P	154	TE-28	98
RI-3I	87	RO-19I	87	RU-5I	89	SAM-4G	438	SIB-2G	439	SLG-12	91	STA-2	94	STS-TV5	139	TAP-2	154	TE-T10	139
RIG-1D	86	RO-20D	87	RU-6I	89	SAM-5G	438	SIB-3G	439	SLG-13	91	STA-2D	94	STS-TV8	139	TAT-1D	277	TE-T10D	139
RIO-1D	86	RO-20I	87	RU-7D	89	SAM-5G	438	SIB-4G	439	SLG-14	91	STA-3	94	STS-TV9	139	TAT-1D	277	TE-T11	139
RIT-1D	87	RO-21D	87	RU-8D	89	SAR-1	90	SIB-5G	439	SLG-15	91	STA-3D	94	STS-X5	139	TAT-2DP	233, 277	TE-T12PLUS	139
RO-1D	87, 175, 252, 260, 264, 277, 298, 306, 307, 312	RO-21I	87	RU-9D	89	SAR-1D	90	SID-1	92	SLG-16	91	STA-4	94	STS-X6	139, 349	TAY-1	97	TE-T60	139
		RO-22I	87	RU-9I	89	SAR-2D	90	SID-2	92	SLG-17	91	STA-4D	94	STUV-1D	96	TC-1	139	TE-T60	139
RO-1DS	170, 172, 249, 257, 276	RO-23D	87	RU-10D	88	SAR-3D	90	SIM-1200	153	SLG-18	91	STA-5	94	STUV-1I	96	TC-2	97	WINDCOLOR	
		RO-24D	88	RU-11D	89	SAR-4	90	SIP-1	247, 294, 301	SLG-19	91	STA-5D	94	STUV-2	96	TC-3	139	TE-T62	139
RO-1I	87, 175, 252, 260, 264, 277, 298, 306, 307, 312	RO-24I	88	RU-12D	89	SAR-4D	90	SIP-2	188, 192, 256	SLG-20	91	STB-2	96	STUV-3	96	TCH-1DP	97	TE-T80	140
		RO-25D	88	RU-13D	89	SAR-5D	90	SIP-3	159, 166, 188, 190, 230, 269, 334	SLG-21	91	STB-2D	96	SUB-2P	273	TCH-1P	97	TE-T80EH	140
RO-1IS	170, 172, 249, 257, 276	RO-25I	88	RU-14D	89	SAR-6	90	SIS-1	92	SLG-22	91	STE-1	95	SUZU-1D	275	TD-1	49	TE-T80SC	140
		RO-26D	88	RU-15	89	SAR-6D	90	SIS-2	92	SLG-23	91	STE-2D	95	SUZU-1I	275	TD-1D	49	TE-T82	140
RO-1X	307	RO-26I	88	RU-16D	89	SAR-6D	90	SIS-3	92	SLG-24	91	STE-3	95	SUZU-1I	275	TD-2	49	TEC-1G	439
RO-2D	87, 175, 264, 277, 298, 306, 307, 312	RO-27D	88	RU-19D	88	SAT-1D	90	SIS-4D	92	SLG-25	91	STE-4	95	SUZU-2D	275	TD-3	49	TEC-2	139
		RO-28D	88	RU-19D	88	SAT-2	90	SIS-5D	92	SM-1	92	STE-5D	95	SUZU-2D	275	TD-4	49	TEI-1D	97
RO-2I	87, 175, 264, 277, 298, 306, 307, 312	RO-28I	88	RU-GC	89	SAT-2	90	SIS-6	92	SM-2	92	STE-6	95	SUZU-2I	275	TD-5	49	TEM-D35	97
		RO-29D	88	RU-GK	89	SCC-1D	91	SIS-6D	92	SM-3	92	STE-7	95	SUZU-3I	340	TD-6	49	TEM-D55	97
RO-3	170, 172, 249, 276, 276	RO-29D	88	RU-GK7	89	SCH-1D	91	SIS-7D	92	SM-3D	92	STE-8D	95	SUZU-4D	319, 321, 329, 330, 332, 336, 337, 340	TD-7	131	TEM-I35	97
		RO-29D	88	RU-GL	89	SCO-1	15	SIS-8D	92	SM-4	92	STE-9D	95			TD-8	49	TEM-I55	97
RO-4D	87, 175, 252, 264, 277, 298, 306, 307, 312, 314	RO-29D	88	RU-GL7	89	SCR-1	138	SIS-9	92	SM-4D	92	STE-10	95	SUZU-4D	319, 321, 329, 330, 332, 336, 338, 340	TD-8D	49	TEU-1	352
		WINDCOLOR		RU-GM	89	SEA-1	138	SIS-9D	92	SOF-1	93	STE-11	95	SUZU-4I	319, 321, 329, 330, 332, 336, 337, 340	TD-9	49	TH-1	98
RO-4I	87, 175, 252, 264, 277, 298, 306, 307, 312, 314	RO-30	87	RU-GM7	89	SEA-2	138	SIX-1	175, 252	SOF-2	93	STE-12	95	SUZU-4I	319, 321, 329, 330, 332, 336, 337, 340	TD-10	49	TI-1	98
		RO-30D	87	RU-GS	89	SEC-1	138	SIX-1P	175	SOFI-1D	93	STE-14D	95	SUZU-4I	319, 321, 329, 330, 332, 336, 338, 340	TD-11D	50	TI-15	98
RO-5D	87, 153, 175, 234, 252	RO-31D	88	RU-GS7	89	SEC-1G	438	SIX-1P1	175, 252	SOFI-2D	93	STF-1	96	SUZU-5	319, 34	TD-12D	50	TIF-15/20	98
		RO-32D	87	RU-K	89	SEC-2	138	SIX-1P2	175	SOFI-2I	93	STF-1D	96	SUZU-5P	319, 34	TD-13D	50	TIF-1D	98
RO-5I	87, 153, 175, 234, 252	RO-33	87	RU-KD	89	SEC-2G	438	SIX-2	175, 252	SOFI-3I	93	STG-1	95	SUZU-6	275	TD-14D	50	TIF-2D	98
		RO-34D	88	RU-L	89	SEC-3	138	SIX-2P	175	SOFI-4	93	STK-1	95	SUZU-7	208, 233, 275	TD-15	50	TIF-25D	98
RO-6D	87, 175, 252, 260, 264, 277, 298, 306, 307, 312	RO-36D	88	RU-M	89	SEC-3G	438	SIX-2P2	175	SOFI-4D	93	STL-1D	94	SUZU-7DP	208, 233, 275	TD-16	131	TIF-30D	98
		RO-37	88	RU-TL	88	SEC-4DP	138	SIX-3P	156, 167, 169, 175, 224, 231, 240	SOFI-5	93	STL-2I	94	SUZU-8	275	TD-17D	50	TIF-40D	98
RO-6I	87, 175, 252, 260, 264, 277, 298, 306, 307, 312	RO-38D	88	RUB-1G	437	SEC-4G	438	SIX-3P1	156, 175, 188, 230, 252	SOFI-6	93	STN-1D	138	SUZU-8I	275	TD-18	50	TIF-50/60	98
		RO-39	88	RUB-2G	437	SEC-7G	439	SIX-3P2	156, 175, 252	SOP-1D	93	STR-1	95	SUZU-9P	275	TD-19	50	TIG-1D	98
RO-7D	87	RO-40D	88	RUB-3G	448	SEL-1	410	SIX-4	175, 252	SOS-1D	93	STR-2	95	SUZU-10	213, 275	TD-20D	50	TIT-2	99
		RO-41	88	RUB-4G	437	SEL-1D	91	SIX-4P	175	SOS-2D	93	STR-3	153, 169	SUZU-10	213, 275	TD-21	49	TIT-3	99
		RO-42	88	RUB-5G	437	SEL-1I	91	SIX-5P	153, 175	SOS-3	93	STR-4	95	SUZU-10	213, 275	TD-22	49	TIT-4	99
		RO-43	88	RUB-6G	445	SEL-2D	91	SJL-1	93	SOS-4D	93	STR-5	95	SUZU-10	213, 275	TD-23	131	TIT-5	99
		RO-44D	88	RUB-7G	437	SEL-2I	91			STS-1D	95	STR-6	95	SUZU-10	213, 275	TD-25	131	TIT-6	140
		RO-45	88	RUB-8G	437	SEL-3D	91			STS-IDP	95	STR-7	95	SUZU-10	213, 275	TD-26D	131	TIT-10	99
				RUB-9G	437					STS-IDP	95	STR-8	95	SUZU-10	213, 275	TD-27	50	TIT-11D	99
				RUE-2G	445					STS-II	95	STR-9	95	SUZU-10	213, 275	TD-28	50	TIT-12D	99
				RUS-1	89							STR-10	95	SUZU-10	213, 275	TD-29	131	TIT-13	99

Índice de referencias
Erreferentzia aurkibidea
Index des références

Referenzverzeichnis
Índice de referências
Spis modeli

REF.	PAG.	REF.	PAG.	REF.	PAG.
TIT-15	99	TOK-32	100	TOK-87D	100
TIT-15D	99	TOK-33	100	TOK-88D	100
TIT-16D	99	TOK-34D	100	TOM-1D	101
TIT-17	99	TOK-37	101	TOP-1	101
TIT-19D	99	TOK-38	101	TOU-1D	101
TIT-1D	98	TOK-39	101	TOV-1	101
TIT-21	140	TOK-40	101	TOV-1G	440
TIT-22	140	TOK-41	101	TOV-2	140
TIT-23	140	TOK-41D	101	TOV-3	101
TIT-24	99	TOK-42	101	TOV-4	140
TIT-25	99	TOK-43	101	TOV-5	140
TIT-26	140	TOK-44	101	TOV-6	140
TIT-27	140	TOK-44D	101	TOV-7	140
TIT-29	140	TOK-45	101	TOV-8D	140
TIT-2D	99	TOK-45D	101	TOYO-2	278, 304
TIT-2GD	99	TOK-46	101	TOYO-3	178, 278
TIT-7D	154, 343	TOK-46D	101	TOYO-3P	178, 278
TIT-8D	99	TOK-47	101	TOYO-4	167, 178, 179, 214, 217, 223, 232, 275, 278, 304
TIT-8GD	99	TOK-47D	101	TOYO-4P	167, 178, 179, 214, 217, 223, 232, 276, 278, 304
TIT-8GI	99	TOK-48	101	TOYO-5	278
TIT-9	99	TOK-48D	101	TOYO-5P	278
TIT-9D	99	TOK-49	101	TOYO-5P1	278
TK-2D	97	TOK-50	101	TOYO-6	154, 278
TKY-1	99	TOK-51	101	TOYO-8	178, 278
TKY-2	140	TOK-52	101	TOYO-8IP	178, 278
TKY-3	140	TOK-53	101	TOYO-8P	178, 278
TOK-2	99	TOK-54	101	TOYO-9	279, 285
TOK-2D	99	TOK-55	101	TOYO-9P	279, 285
TOK-3	100	TOK-56D	100	TOYO-9P1	279, 285
TOK-3D	100	TOK-58	100	TOYO-9P2	279
TOK-4D	100	TOK-59	100	TOYO-10	279
TOK-5D	100	TOK-60	100	TOYO-10P	279
TOK-6	100	TOK-61	100	TOYO-10P1	279
TOK-8	101	TOK-62	101	TOYO-11	279
TOK-9	100	TOK-62D	101	TOYO-11P	279
TOK-10D	100	TOK-63	101	TOYO-11P1	279
TOK-11	100	TOK-64	101	TOYO-12	279
TOK-12	100	TOK-65	101	TOYO-12D	279
TOK-13D	100	TOK-66	101	TOYO-12DP1	279
TOK-14D	100	TOK-67	101	TOYO-12P1	279
TOK-15	100	TOK-68	101	TOYO-13	279
TOK-16D	100	TOK-69	101	TOYO-13P1	279
TOK-17D	100	TOK-6D	100	TOYO-14	167, 178, 179, 214, 217, 223, 232, 275, 278, 304
TOK-18	100	TOK-70	101	TOYO-14P	167, 178, 179, 214, 217, 223, 232, 276, 278, 304
TOK-19	100	TOK-71	101	TOYO-15	206, 279
TOK-20	100	TOK-71D	101	TOYO-15DP	207, 279
TOK-21	101	TOK-72	101	TOYO-15P	207, 279
TOK-21D	101	TOK-73	101	TOYO-15P10	279
TOK-22	101	TOK-74	101	TOYO-16	280
TOK-23	100	TOK-75	100	TOYO-16P	280
TOK-24	101	TOK-76	101	TOYO-16P1	280
TOK-25	100	TOK-77	100	TOYO-17	280
TOK-26	100	TOK-78	100	TOYO-17P	280
TOK-27	100	TOK-7D	100	TOYO-18P	207, 231, 236, 280
TOK-28D	100	TOK-82	100	TOYO-19P	280
TOK-29D	100	TOK-83	100	TOYO-20D	280, 285
TOK-30	100	TOK-83D	100	TOYO-22	280
TOK-31	100	TOK-84D	100	TOYO-22D	280
		TOK-85D	100	TOYO-23	280
		TOK-86D	100	TOYO-23P	280
				TOYO-24	280
				TOYO-25	280, 352
				TOYO-26	280
				TOYO-27	352
				TOYO-28P	281
				TOYO-29	281
				TOYO-30P1	154, 231, 267, 273, 281
				TOYO-37D	281
				TOYO-40	207, 281
				TOYO-40D	207, 281
				TOYO-41P	207, 231, 280
				TOYO-K1	167, 178, 179, 214, 217, 223, 232, 275, 278, 304
				TOYO-K1P	167, 178, 179, 214, 217, 223, 232, 276, 278, 304
				TOYO-KIP	167, 178, 179, 214, 217, 223, 232, 276, 278, 304
				TRI-1D	102
				TRI-1I	102
				TR-1G	440
				TRI-2D	102
				TRI-2I	102
				TRI-3D	102
				TRI-3I	102
				TRI-4D	102
				TRI-4I	102
				TRI-5D	102
				TRI-5I	102
				TRI-6D	102
				TRI-6I	102
				TRI-7D	102
				TRI-7I	102
				TRI-8D	102
				TRI-8I	102
				TRI-9D	102
				TRI-9DSP	102
				TRI-9I	102
				TRI-10D	102
				TRI-10I	102
				TRI-11D	102
				TRI-11I	102
				TRI-12D	102
				TRI-12I	102
				TRI-13	102
				TRI-14	102
				TRI-15	102
				TRI-16	102
				TRI-17	102
				TRI-17D	102
				TRI-18	102
				TRI-18D	102
				TRI-19	103
				TRI-19D	103
				TRI-20	103
				TRI-26D	103
				TRL-1P	101, 154, 349
				TRL-2	102
				TRL-3	102
				TRL-3D	102
				TRL-5P	102
				TRL-6	102
				TRL-6D	102
				TRM-4	103
				TRM-11D	103
				TRM-18DP	352
				TRO-1	139
				TRO-1D	139
				TRP-1D	342
				TRP-2	342
				TRU-7	104
				TRU-8P	104
				TRV-1	101
				TRV-1D	101
				TSI-1G	440
				TST-1	102
				TTN-1G	440
				TTN-2G	440
				TUF-1X	307
				TUF-2X	308
				TUF-3X	308
				TUL-1D	104
				TUL-2D	104
				TUS-1D	104
				TUS-1G	440
				TUS-2D	104
				TV-1D	103
				TV-1G	410
				TV-2D	103
				TV-2G	410
				TV-3D	103
				TV-3G	410
				TV-4D	103
				TV-5G	411
				TV-5G	411
				TV-7G	410
				TV-8G	410
				TV-9G	410
				TV-10G	410
				TV-11	103
				TV-11G	410
				TV-12	103
				TV-12G	410
				TV-13	103
				TV-13G	411
				TV-14G	411
				TV-15D	103
				TV-15G	411
				TV-16D	103
				TV-16G	411
				TV-17	103
				TV-17D	103
				TV-17G	411
				TV-18D	103
				TV-18G	411
				TV-19D	103
				TV-19G	411
				TV-20	103
				TV-20G	411
				TV-21	103
				TV-21G	411
				TV-22	103
				TV-22D	103
				TV-22G	411
				TV-23	103
				TV-23D	103
				TV-23G	411
				TV-24G	411
				TV-25G	411
				TV-26G	411
				TV-27G	411
				TV-30	103
				TV-31	103
				TV-32	103
				TV-34	103
				TV-35	103
				TV-36	103
				TV-37	103
				TV-38	103
				TV-39	103
				TV-40D	103
				TV-41	103
				TX-1	141
				TX-2	141
				TX-3D	106
				TX-12	106
				TX-13D	106
				TX-16	106
				TX-17	141
				TX-22	141
				TZ-1	104
				TZ-1D	104
				U-1D	106
				U-1G	458
				U-1G NIQ	458
				U-1I	106
				U-1X	308
				U-2D	106
				U-2I	106
				U-3D	107
				U-3I	107
				U-4AD	107
				U-4AI	107
				U-4D	107
				U-4GD	107
				U-4I	107
				U-4JD	107
				U-4JI	107
				U-4TD	107
				U-4TI	107
				U-5AD	107
				U-5AI	107
				U-5BD	107
				U-5BI	107
				U-5CD	107
				U-5CI	107
				U-5D	107
				U-5D WINDCOLOR	107
				U-5DD	107
				U-5DI	107
				U-5DSP	108
				U-5ED	107
				U-5EI	107
				U-5FD	107
				U-5FI	107
				U-5GD	107
				U-5I	107
				U-5I WINDCOLOR	107
				U-5JD	108
				U-5JI	108
				U-5KD	108
				U-5KI	108
				U-5MD	108
				U-5MI	108
				U-5PD	108
				U-5PI	108
				U-5QD	108
				U-5QI	108
				U-5SD	108
				U-5SI	108
				U-5SP	108
				U-5TD	108
				U-5TI	108
				U-5VD	108
				U-5VI	108
				U-5XD	108
				U-5XI	108
				U-5YD	108
				U-5YI	108
				U-6BD	108
				U-6D	108
				U-6D WINDCOLOR	108
				U-6GD	108
				U-6I	108
				U-7	109
				U-7D	109
				U-8	109
				U-8D	109
				U-8PD	

Índice de referencias
Erreferentzia aurkibidea
Index des références

Referenzverzeichnis
Índice de referências
Spis modeli

REF.	PAG.	REF.	PAG.	REF.	PAG.	REF.	PAG.	REF.	PAG.	REF.	PAG.	REF.	PAG.	REF.	PAG.	REF.	PAG.		
UN-FR	105, 163, 165, 168, 169, 220, 224, 231, 240, 267, 281, 292, 296, 302, 312, 319, 320, 349	VA-3T	445	VA-50	112	VGf-5I	113	VO-HV	164, 197, 255, 269, 286, 287, 289, 290, 298, 301, 310, 313, 314	WAS-2P	163, 224, 236, 273, 282, 313	WIL-33D	116	YA-2X	308	YA-33D	119	YA-226	120
		VA-4	110	VA-51	112	VI-II	113					WIL-34D	116	YA-3D	118	YA-34D	119	YA-227	120
		VA-4D	110	VA-52	112	VI-2D	113					WIL-35D	116	YA-3G	441	YA-36D	119	YA-228	120
		VA-5	110	VA-53	112	VI-2I	113					WIL-36D	116	YA-3I	118	YA-37	119, 352	YA-229	120
		VA-5T	446	VA-54	112	VI-4D	113	VO-HVP	164, 197, 256, 286, 287, 289, 290, 298, 301, 310, 313, 314	WAS-4	154, 298	WIL-37D	116	YA-3X	308	YA-37D	119, 352	YA-232	120
UN-FS	106, 163, 169, 214, 220, 224, 225, 231, 240, 267, 282, 292, 292, 302, 337, 349	VA-6	175, 253, 277	VA-55	112	VI-4DP	113, 349			WAS-5	233, 297, 298	WIL-38D	116	YA-4G	441	YA-38D	119	YA-272D	119
		VA-6P	175, 253, 277	VA-56	141	VI-4I	113	VO-HVP1	155, 164, 286, 287, 289, 290	WAS-6	233, 297, 298	WIL-39D	116	YA-4X	308	YA-39	118	YA-273D	120
		VA-7	260, 264, 277, 312	VA-57	112	VI-4IP	113, 349			WAS-7	352	WIL-40D	116	YA-5D	118	YA-39D	118	YA-280D	142
		VA-8D	111	VA-58	141	VI-5D	114			WAS-9	352	WIL-41D	116	YA-5G	412	YA-46D	119	YA-281D	142
		VA-8D	111	VA-59	112	VI-6D	114			WAS-9D	352	WIL-43D	116	YA-5I	118	YA-50	119	YA-282	142
		VA-8D	111	VA-60	112	VI-7	113	VO-K	286	WBS-1	115	WIL-44	116	YA-5X	308	YA-50D	119	YA-283D	142
UN-FT	163, 165, 196, 220, 224, 231, 240, 267, 282, 296, 302, 303, 312	WINDCOLOR		VA-61C1	357	VI-8	114	VO-KP	286	WE-1G	440	WIL-45D	116	YA-6D	118	YA-51	119	YA-286D	142
		VA-9D	111	VA-61C2	357	VI-8D	114	VO-L	286	WE-2G	440	WIL-46D	116	YA-6I	118	YA-51D	119	YA-287D	120
		VA-10	161, 181, 182, 260, 262, 264, 312	VA-61C3	357	VI-9D	113	VOL-1	283	WE-4D	115	WIL-47D	116	YA-6X	308	YA-52D	119	YA-288D	119
		VA-11	112	VA-62	111	VI-10	114	VOL-1P	283	WE-4I	115	WIL-48D	116	YA-7D	118	YA-53	119	YA-300D	120
UN-MRN	105, 163, 165, 168, 169, 220, 224, 231, 240, 267, 281, 292, 296, 302, 312, 319, 320, 349	VA-12D	111	VA-62D	111	VI-11	114	VOL-2	242, 282, 284	WE-5D	115	WIL-49D	116	YA-7I	118	YA-53D	119	YA-301D	142
		VA-13D	110	VA-70	141	VI-11D	114	VOL-2D	242, 282, 284	WE-5I	115	WIL-50D	116	YA-8D	118, 202, 225, 297, 303, 352	YA-57	119	YA-306	142
		VA-13I	110	VA-75D	110	VI-12	113	VOL-3	242, 282, 284, 295	WE-6D	115	WIL-51D	116	YA-8I	118, 202, 225, 297, 303, 352	YA-57D	119	YAMA-1D	293, 343
		VA-14D	111	VA-75D	111	VI-14	142	VOL-4	284	WEB-1	115	WIL-53	116			YA-58	119	YAMA-1I	293, 343
		VA-15	111	WINDCOLOR		VI-15	113	VOL-5P	284	WEB-2	115	WIL-54	116	YA-9I	118, 202, 225, 297, 303, 352	YA-58D	119	YAMA-2D	293, 343
		VA-16	277	VA-91	141	VI-16D	114	VO-M	286, 291, 307	WEB-3	115	WIL-55	116			YA-59	119	YAMA-2I	293, 343
UN-NC	154	VA-17P	260	VA-400	412	VI-1D	113	VO-MP	286, 291, 307	WEI-1	115	WIL-56	116	YA-10	118	YA-59D	119	YAMA-3D	343
UN-NG	105, 163, 165, 168, 169, 220, 224, 231, 240, 267, 281, 292, 296, 302, 312, 319, 320, 349	VA-18	253	VA-700	412	VILL-1G	446	VO-N	164, 197, 255, 269, 286, 287, 289, 289, 290, 298, 301, 310, 313, 314	WEI-2	115	WIL-57D	116	YA-10D	118	YA-65	142	YAMA-3I	343
		VA-19	110	VA-DHP	111	VIN-1D	113			WEI-3	115	WIL-58D	116	YA-11D	118, 225, 297, 306, 352	YA-72	119	YAMA-4D	293, 343
		VA-20	110	VA-LA	111	VLK-1	114	VO-NP	164, 197, 256, 286, 287, 289, 290, 298, 301, 310, 313, 314	WEI-4	115	WIL-59D	116	YA-11I	118, 225, 297, 306, 352	YA-79D	119	YAMA-5D	343
		VA-21	110	VA-LB	111	VLK-2	114			WEI-5	115	WIL-60D	116			YA-81	142	YAMA-5I	343
		VA-22	110	VA-LC	111	VND-1	113			WEI-6	115	WIL-61	116	YA-12D	118	YA-85D	120	YAMA-6D	293, 343
UN-NH	231, 240, 282	VA-23	110	VA-LD	111	VND-1D	113	VO-R	286, 287, 291, 307	WES-1D	115	WIL-62	116	YA-13D	118	YA-88	120	YAMA-6I	293, 343
UN-TF	163, 165, 196, 220, 224, 231, 240, 267, 282, 296, 302, 303, 312	VA-24D	111	VA-LE	111	VND-2	113	VO-RP	286, 287, 291, 307	WHI-1D	115	WIL-63D	116	YA-14D	118	YA-89	120	YAMA-7D	293, 343
		VA-24I	111	VA-LF	111	VND-2D	113			WIL-1D	115	WIL-65D	116	YA-15D	118	YA-91	119	YAMA-7I	293, 343
		VA-25	141	VA-LG	111	VND-3	113	VO-VA	154	WIL-2D	116	WIL-66D	116	YA-16D	118	YA-92	119	YAMA-8D	293, 343
		VA-26	141	VA-LH	111	VO-1	154, 301	VO-VAP	154	WIL-3D	116	WIN-1D	117	YA-17D	118	YA-92D	119	YAMA-8I	293, 343
		VA-27	141	VA-LN	111	VO-2	155, 164, 269, 286, 289, 290	VO-VB	164, 197, 247, 255, 269, 286, 287, 289, 290, 298, 301, 310, 313, 314	WIL-4D	116	WIN-1I	117	YA-18D	167, 264	YA-93	119	YAMA-9D	343, 343
URB-1	110	VA-28	141	VA-RA	111	VO-2DP	155, 164, 197, 286, 287, 289, 290			WIL-5	116	WIN-2D	117	YA-19D	167, 264	YA-94	119	YAMA-9I	343, 343
URB-1D	110	VA-29	111	VA-RB	111	VO-2DP1	287, 289			WIL-5D	116	WIN-3D	117	YA-20D	167, 264	YA-95	119	YAMA-10D	293, 343
URB-2	110	VA-29D	111	VA-RC	111	VO-2P	155, 164, 197, 269, 286, 289, 290			WIL-8	116	WIN-4D	117	YA-21D	167, 265	YA-96	119	YAMA-10I	293, 343
URB-3D	141	VA-30	111	VA-RD	111	VO-2P1	287, 289			WIL-9	116	WIN-5	117	YA-22D	167, 265	YA-97D	120	YAMA-11D	293, 343
URB-4D	141	VA-31D	111	VA-RDH	111	VO-5P	287	VO-VBP	164, 197, 247, 256, 286, 287, 289, 290, 298, 301, 310, 313, 314	WIL-10	116	WIN-5D	117	YA-25I	118	YA-98D	120	YAMA-11I	293, 343
URKO-1D	110	VA-32D	111	VA-RDM	111	VO-6D	287			WIL-11	116	WIN-6D	117	YA-26I	118	YA-99D	120	YAMA-12D	293, 343
URKO-II	110	VA-33D	111	VA-RE	111	VO-7	183, 246, 285, 288, 290, 297, 305, 307			WIL-12	116	WIN-21	117	YA-27	119, 154, 303, 352	YA-100D	120	YAMA-12I	293, 343
URKO-2D	110	VA-34	260	VA-RF	111			VO-VBP1	329, 331	WIL-13	116	WIN-22	117	YA-27D	119, 154, 303, 352	YA-100D	120	YAMA-13D	293, 343
URKO-2I	110	VA-34P	176, 26	VA-RG	111	VO-8P	155, 164, 197, 286, 287, 289, 290			WIL-14	116	WIN-5D	117			YA-101D	120	YAMA-14D	293, 343
URKO-3D	110	VA-34P1	176, 26	VA-RH	111	VO-8P1	287, 289			WIL-15	116	WIN-5D	117	YA-21I	167, 265	YA-102D	120	YAMA-14I	293, 343
URKO-3I	110	VA-34P2	176, 26	VA-RHM	111	VO-AH	164, 197, 255, 269, 286, 287, 289, 290, 298, 301, 310, 313, 314			WIL-16	116	WIN-5D	117	YA-22D	118	YA-103D	120	YAMA-15D	293, 343
URKO-4	110	VA-35	111	VA-RJ	111					WIL-17D	116	WIN-5D	117	YA-22I	118	YA-108	120	YAMA-16D	293, 343
URKO-4	460	VA-35D	111	VA-RK	111	VO-AHP	164, 197, 256, 286, 287, 289, 290, 298, 301, 310, 313, 314			WIL-18	116	WIN-5D	117	YA-23	118	YA-111	120	YAMA-17D	293, 343
V-1G	458	VA-36	112	VA-RL	111					WIL-19D	116	WIN-5D	117	YA-24D	118	YA-112	120	YAMA-18D	341, 344
V-1G(CV)	458	VA-37	112	VA-RM	111					WIL-20	142	WIN-5D	117	YA-24I	118	YA-113	120	YAMA-18I	341, 343
V-2G	458	VA-38	112	VA-RN	111					WIL-22	116	WIN-5D	117	YA-25D	118	YA-113	120	YAMA-19D	341, 343
V-2G(CV)	458	VA-39	112	VA-ROK	111					WIL-25	116	WIN-5D	117	YA-25I	118	YA-142D	120	YAMA-18IP	276, 293
V-3G	458	VA-40	112	VB-ID	113					WIL-26	116	WNC-1	117	YA-26I	118	YA-186D	120	YAMA-19D	341, 343
V-3G(CV)	458	VA-41	112	VB-2D	113					WIL-27	116	WST-1D	115, 352	YA-27	119, 154, 303, 352	YA-206D	120	YAMA-19DP	276, 293
V-4G(CV)	458	VA-42	112	VB-3D	113	VO-AHP	164, 197, 256, 286, 287, 289, 290, 298, 301, 310, 313, 314			WIL-28	116	WST-2D	115, 352	YA-27D	119, 154, 303, 352	YA-209D	120	YAMA-18DP	341, 344
V-5G(CV)	458	VA-43	112	VB-4D	113					WIL-29	116	WT-1	117			YA-210D	120	YAMA-18I	341, 343
VA-1	110	VA-44	112	VB-5D	113					WIL-26	116	YA-1D	117	YA-28	119	YA-212D	120	YAMA-18IP	276, 293
VA-1T	445	VA-45	112	VE-ID	113					WIL-27	116	YA-1G	440	YA-28D	119	YA-216	120	YAMA-18IP	341, 344
VA-2	110	VA-46	112	VG-ID	114	VO-FHP	286			WIL-28	116	YA-1I	117	YA-29	118	YA-217	120	YAMA-19D	341, 343
VA-2T	445	VA-47	112	VGf-4D	113	VO-FHP1	287			WIL-29	116	YA-1X	308	YA-30	119, 46	YA-219	120	YAMA-19DP	276, 293, 341, 344
VA-3	110, 154	VA-48	112	VGf-4I	113					WIL-30	116	YA-2D	117	YA-31D	119	YA-220	120		
VA-3I	110, 154	VA-49	112	VGf-5D	113					WIL-31D	116	YA-2G	440	YA-32D	117	YA-221	120		
										WIL-32	116	YA-2I	117			YA-225	120		

Índice de referencias
Erreferentzia aurkibidea
Index des références

Referenzverzeichnis
Índice de referências
Spis modeli

REF.	PAG.
YAMA-19IP	276, 293, 341, 344
YAMA-20D	341, 343
YAMA-20DP	276, 293, 341, 344
YAMA-20I	341, 343
YAMA-20IP	276, 293, 341, 344
YAMA-21I	326, 344
YAMA-21IP	326, 344
YAMA-22DP	341
YAMA-22IP	341
YAMA-23DP	341
YAMA-23IP	341
YAMA-24DP	341
YAMA-24IP	341
YAMA-25DP	344
YAMA-25P	344
YAMA-26	344
YAMA-26D	344
YAMA-26DP	344
YAMA-26P	344
YAMA-27	329, 333, 344
YAMA-27D	329, 333, 344
YAMA-27DP	329, 333, 344
YAMA-27P	329, 333, 344
YAMA-28P	276, 293, 341, 344
YAMA-29P	276, 293, 341, 344
YAMA-30P	333, 344
YAMA-32DP	344
YAMA-33DPI	344
YAMA-34	344
YAMA-34D	344
YAMA-36DP	345
YAR-1	143
YAR-2	143
YAR-3	143
YAR-4D	143
YET-1	120
YET-1D	120
YET-2	121
YET-2D	121
YET-3D	121
YET-4	121
YET-4D	121
YET-5	121
YET-5D	121
YET-6	121
YET-6D	121
YET-7	121
YET-7D	121
YET-8	121
YET-8D	121
YET-9	121
YET-9D	121
YET-10	121
YET-10D	121
YET-11	121

REF.	PAG.
YET-11D	121
YET-12	121
YET-13	121
YET-14	120
YET-14D	120
YET-15	121
YET-16	121
YET-17D	121
YET-18	121
YET-18D	121
YET-19D	143
YU-1D	294
YUH-1D	121
YUH-2D	121
YUH-3D	121
YW-1P	122
ZA-6DP	326, 339
ZA-1	122, 274, 317, 318, 319, 321, 322, 323, 324, 326, 332, 333, 334, 335, 336, 337, 338, 339, 340, 341, 345, 349
ZA-1P	122, 274, 317, 318, 319, 321, 322, 323, 324, 326, 332, 333, 334, 335, 336, 337, 338, 339, 340, 341, 345, 349
ZA-2P	154, 317, 318, 321, 323, 326, 329, 333, 336, 339, 341, 345, 349
ZA-3D	349
ZA-4DP	154, 317, 318, 321, 323, 326, 329, 333, 336, 339, 341, 345, 349
ZA-5DP	155
ZA-5P	155
ZA-6DP	320
ZA-6DPI	317, 318, 333, 339, 345
ZA-7DP	326, 339
ZA-7DPI	320, 326, 339
ZA-8P	321, 329, 332, 333, 339
ZA-9P	329
ZA-9P1	317, 318, 326, 327, 329, 331, 334, 335, 341, 342, 345
ZA-9P2	317, 318, 333, 339, 345
ZA-10	349
ZA-12	122, 338

REF.	PAG.
ZA-13P	154, 317, 318, 321, 323, 326, 329, 333, 336, 339, 341, 345, 349
ZE-1	59
ZE-1D	59
ZE-1X	308
ZE-2	59
ZE-2D	59
ZE-2X	308
ZE-3X	309
ZE-4X	309
ZE-5D	59
ZE-5I	59
ZE-5X	309
ZE-6	59
ZE-6D	59
ZE-6X	309
ZE-7D	59
ZE-7X	309
ZE-8	59
ZE-8X	309
ZE-9D	59
ZE-9X	309
ZE-10D	60
ZE-11D	60
ZE-13	60
ZE-15	59
ZE-16D	59
ZE-17D	59
ZE-18D	59
ZE-19	59
ZE-20	59
ZE-21D	59
ZE-22	59
ZE-23D	60
ZE-24D	60
ZE-25D	60
ZE-26D	60
ZE-27D	60
ZE-28D	60
ZE-29D	60
ZE-30D	60
ZE-31D	60
ZE-32D	60
ZE-33D	60
ZE-34D	60
ZE-35	60
ZE-35D	60
ZE-36D	59
ZE-37D	59
ZE-38	59
ZE-39	59
ZE-40D	59
ZE-41	59
ZE-42	59
ZE-43	59
ZE-44D	59
ZE-45D	59

REF.	PAG.
ZE-46	59
ZE-47D	60
ZE-48D	60
ZE-49D	60
ZE-50D	60
ZE-51D	60
ZE-52D	60
ZE-53D	60
ZE-54D	60
ZE-55D	60
ZE-56D	60
ZE-57D	60
ZE-58D	60
ZE-59D	60
ZE-60D	60
ZE-61D	60
ZE-62D	60
ZE-63D	60
ZE-64D	60
ZE-65D	60
ZE-66D	60
ZE-67D	60
ZE-68D	60
ZE-69D	60
ZE-70D	60
ZE-71D	59
ZE-72	59
ZE-73	59
ZE-74	59
ZE-75	59
ZE-76D	59
ZE-77D	59
ZE-78D	59
ZE-79	59
ZE-80	59
ZE-81	59
ZE-82	59
ZE-83	59
ZE-84	59
ZE-85	59
ZE-86D	59
ZE-87	59
ZE-88	59
ZE-89	59
ZE-90	59
ZE-91D	59
ZE-92D	59
ZE-93D	59
ZE-94D	59
ZE-95D	59
ZE-96D	59
ZE-97D	59
ZE-98	59
ZE-99	59
ZE-101	59
ZE-102	59
ZE-103	59
ZE-104D	59
ZE-105D	60
ZE-106D	60

REF.	PAG.
ZE-107D	60
ZE-108D	60
ZE-109D	60
ZE-110D	60
ZE-111D	60
ZE-112D	60
ZE-113D	60
ZE-114D	60
ZE-115D	60
ZE-116D	60
ZE-117D	60
ZE-118	59
ZE-119D	59
ZE-120	59
ZE-121D	60
ZE-122D	60
ZE-123D	60
ZE-124	60
ZE-125D	60
ZE-126D	60
ZE-127D	60
ZE-128	60
ZE-129D	60
ZE-130	60
ZE-131	60
ZE-132D	60
ZE-133D	60
ZE-134	60
ZE-135D	60
ZE-136D	60
ZE-137	60
ZE-138	60
ZE-139D	60
ZE-140	60
ZE-141D	60
ZE-142	60
ZE-143	60
ZE-144D	60
ZE-145D	60
ZE-146D	60
ZE-147D	60
ZE-148D	60
ZE-149	60
ZE-14D	59
ZE-150	60
ZE-151D	60
ZE-152D	60
ZE-153D	60
ZE-154D	60
ZE-155D	60
ZE-156	60
ZE-157	60
ZE-158	60
ZE-159D	60
ZE-160D	61
ZE-K1	61
ZE-K2	61
ZE-K5	61
ZE-K6	61

REF.	PAG.
ZE-N1	61
ZEN-ID	122
ZA-4DP	317, 318, 321, 323, 326, 329, 333, 336, 339, 341, 345
ZA-4DP	349
ZA-5DP	155
ZA-5P	155
ZA-6DP	320
ZA-6DPI	317, 318, 333, 339, 345
ZA-7DP	326, 339
ZA-7DPI	320
ZA-7DPI	326, 339
ZA-8P	321, 329, 332, 333, 339
ZA-9P	329
ZA-9P1	317, 318, 326, 327, 329, 331, 334, 335, 341, 342, 345
ZA-9P2	317, 318, 333, 339, 345
ZE-1	59
ZE-100	59
ZE-101	59
ZE-102	59
ZE-103	59
ZE-104D	59
ZE-105D	60
ZE-106D	60
ZE-107D	60
ZE-108D	60
ZE-109D	60
ZE-110D	60
ZE-111D	60
ZE-112D	60
ZE-113D	60
ZE-114D	60
ZE-115D	60
ZE-116D	60
ZE-117D	60
ZE-118	60
ZE-119D	60
ZE-120	60
ZE-121D	60
ZE-122D	60
ZE-123D	60
ZE-124	60
ZE-125D	60
ZE-126D	60
ZE-127D	60
ZE-128	60
ZE-129D	60
ZE-130	60
ZE-131	60
ZE-132D	60
ZE-133D	60
ZE-134	60
ZE-135D	60
ZE-136D	60
ZE-137	60
ZE-138	60
ZE-139D	60
ZE-140	60
ZE-141D	60
ZE-142	60
ZE-143	60
ZE-144D	60
ZE-145D	60
ZE-146D	60
ZE-147D	60
ZE-148D	60
ZE-149	60
ZE-14D	59
ZE-150	60
ZE-151D	60
ZE-152D	60
ZE-153D	60
ZE-154D	60
ZE-155D	60
ZE-156	60
ZE-157	60
ZE-158	60
ZE-159D	60
ZE-160D	61
ZE-K1	61
ZE-K2	61
ZE-K5	61
ZE-K6	61

REF.	PAG.
ZE-131	60
ZE-132D	60
ZE-133D	60
ZE-134	60
ZE-135D	60
ZE-136D	60
ZE-137	60
ZE-138	60
ZE-139D	60
ZE-140	60
ZE-141D	60
ZE-142	60
ZE-143	60
ZE-144D	60
ZE-145D	60
ZE-146D	60
ZE-147D	60
ZE-148D	60
ZE-149	60
ZE-14D	59
ZE-15	59
ZE-150	60
ZE-151D	60
ZE-152D	60
ZE-153D	60
ZE-154D	60
ZE-155D	60
ZE-156	60
ZE-157	60
ZE-158	60
ZE-159D	60
ZE-160D	61
ZE-16D	59
ZE-17D	59
ZE-18D	59
ZE-19	59
ZE-1D	59
ZE-1X	308
ZE-2	59
ZE-20	59
ZE-21D	59
ZE-22	59
ZE-23D	60
ZE-24D	60
ZE-25D	60
ZE-26D	60
ZE-27D	60
ZE-28D	60
ZE-29D	60
ZE-2D	59
ZE-2X	308
ZE-30D	60
ZE-31D	60
ZE-32D	60
ZE-33D	60
ZE-34D	60
ZE-35	60
ZE-35D	60
ZE-36D	60
ZE-37D	59
ZE-38	59
ZE-39	59
ZE-40D	59
ZE-41	59
ZE-42	59
ZE-43	59
ZE-44D	59
ZE-45D	59

REF.	PAG.
ZE-37D	59
ZE-38	59
ZE-39	59
ZE-3X	309
ZE-40D	59
ZE-41	59
ZE-42	59
ZE-43	59
ZE-44D	59
ZE-45D	59
ZE-46	59
ZE-47D	60
ZE-48D	60
ZE-49D	60
ZE-4X	309
ZE-50D	60
ZE-51D	60
ZE-52D	60
ZE-53D	60
ZE-54D	60
ZE-55D	60
ZE-56D	60
ZE-57D	60
ZE-58D	60
ZE-59D	60
ZE-5D	59
ZE-5I	59
ZE-5X	309
ZE-6	59
ZE-60D	60
ZE-61D	60
ZE-62D	60
ZE-63D	60
ZE-64D	60
ZE-65D	60
ZE-66D	60
ZE-67D	60
ZE-68D	60
ZE-69D	60
ZE-6D	59
ZE-6X	309
ZE-70D	60
ZE-71D	59
ZE-72	59
ZE-73	59
ZE-74	59
ZE-75	59
ZE-76D	59
ZE-77D	59
ZE-78D	60
ZE-79	59
ZE-7D	59
ZE-8	59
ZE-80	59
ZE-81	59
ZE-82	59
ZE-83	59
ZE-84	59
ZE-85	59

REF.	PAG.
------	------

REF.	PAG.
------	------

Índice de marcas
Marken aurkibidea
Index des marques

Markenverzeichnis
Índice de marcas
Spis marek

FOR:	NAT.	PAG.
101 ®	PORTUGAL	
126 ®	SUECIA	402
303 ®	TAIWÁN	2
333 ®	ISRAEL	2
3M ®	CHINA	2
45 ®	RUSIA	2
716 ®	PORTUGAL	402
A.M. BARAS ®	REINO UNIDO	2284
ABA ®	FINLANDIA	2
ABARTH ®	ITALIA	354
ABBES ®		68, 348
ABC ®	ESPAÑA	2, 124
ABLOY ®	FINLANDIA	2, 3
ABSA ®	ESPAÑA	3, 25, 87, 146, 150, 153, 172, 175, 193, 230, 234, 252, 260, 264, , 277, 298, 306, 307, 312, 314
ABT ®		113, 114
ABUS ®	ALEMANIA	3, 4, 5, 6, 7, 11, 21, 30, 31, 49, 54, 58, 64, 81, , 87, 101, 113, 114, 118, 119, 122, 124, 128, 150, 154, 225, 297, 303, 306, 346, 347, 349, 346, 347, 349, 350, 352
ACE ®		146, 326
ADAMSRITE ®	REINO UNIDO	7
ADEMCO ®		119, 146, 326
AEP ®	RUSIA	7
AGA ®	ESPAÑA	7, 8, 15, 24, 146, 326, 402, 443, 446, 447, 452, 453
AGB ®	ITALIA	8, 125, 409
AGC ®	PORTUGAL	8, 136, 372
AGE ®	JAPÓN	8
AGUEDA ®		97
AGUIA ®	PORTUGAL	8
AGUT ®	ESPAÑA	9
AHRAM ®	EGIPTO	125
AIZPUTE ®	RUSIA	9
AKARSAN ®	TURQUÍA	412
AKIRA ®		120, 121
AKS ®		155, 163, 164, 169, 177, 195, 197, 247, 248, 255, 256, 268, 269, 271, , 285, 286, 287, 288, 289, 290, 291, 298, 299, 301, 307, 309, 310, 313, 314
AL ®		10
ALA ®		31, 372
ALDRIDGE ®	REINO UNIDO	9
ALE ®	ESPAÑA	9
ALEDAL ®	SUECIA	443
ALFA ®		7, 9, 51
ALFA ROMEO ®	ITALIA	354
ALIANCA ®	BRASIL	9
ALLGOOD ®		26
ALLIANDIS ®		133
ALPHA ®	JAPÓN	9, 10, 146, 326
ALSO ®		65225
ALTAY ®	RUSIA	10
ALUNORM ®		32
AM ®		78
AMARU ®	PORTUGAL	10
AMERICAN LOCK ®	ESTADOS UNIDOS	10
AMERICAN MOTORS ®		64, 65, 159, 224, 257, 306, 351
AMIG ®	ESPAÑA	10, 65, 125, 126

FOR:	NAT.	PAG.
ANA ®		377
ANCHOR ®		3, 4, 5, 10, 346
ANKE ®		23
ANKER ®	PAÍSES BAJOS	10, 11
ANKERSLOT ®		10, 7
ANLO ®		54444
ANTAR ®	FRANCIA	11, 87, 88
ANTONIOLI ®	ITALIA	412, 413
APEKS ®		125
APEX ®	RUSIA	11, 125
APRI ®		78
APRILIA ®		317, 318, 333, 339, 345
ARCU ®	ESPAÑA	11, 129, 443, 444
AREL ®	REINO UNIDO	11
ARES ®	RUSIA	447
ARFE ®		3, 11, 35, 86, 150, 215, 230, 274, 446, 447, 449
ARMAN ®		162, 163, 166, 178, 186, 187, 188, 189, 191, 192, 193, 194, 223, 224, , 231, 236, 256, 268, 269, 273, 281, 282, 294, 313
ARMOR ®		87
ARMSTRONG ®		4, 11
ARNOU ®		25
AROUCA ®	BRASIL	11
ARREGUI ®		3, 7, 12, 21, 25, 43, 49, 150, 193, 230, 274
ARROW ®	ESTADOS UNIDOS	12
ARSENEVSK ®	RUSIA	12
ARTEB ®		159, 166, 188, 190, 230, 269, 334
ASEC ®		9, 12
ASHICO ®	CHINA	126
ASIA ®	TAIWÁN	12, 120, 121
ASPA ®	PAÍSES BAJOS	12, 37
ASSA ®	SUECIA	12, , 13, 14, 89, 97, 291, 318, 342, 346, 347, 402, 403, 413
ASSA ABLOY ®		120
ASTON MARTIN ®	ALEMANIA	354
ASTRAL ®		128
ATAL ®		68, 69, 110, 151, 348
ATL ®		22
ATLANTIC ®		131
ATLAS ®	ESTADOS UNIDOS	14, 96
ATP ®		25
ATRA ®		129, 133, 413, 233
AUDI ®	ALEMANIA	354
AUMON ®	ESPAÑA	14, 35345
AUNO ®		412, 413
AUTOBLOCK ®		153, 188, 190
AVA-CHUBB ®		29, 128
AVANGARD ®	RUSIA	14
AXA ®	SUECIA	14, 126, 128, 129
AXIS ®		128
AYPE ®	ESPAÑA	444
AZBE ®	ESPAÑA	14, 15, 117, 126
AZKOYEN ®	ESPAÑA	15
B+D ®	REINO UNIDO	15, 73
BAB ®		3, 15, 16, 35, 42, 87
BAGEM ®	ESPAÑA	2, 124, 126

FOR:	NAT.	PAG.
BALING LOCK ®		140
BALTIKA ®	RUSIA	16
BANE SEKULIC ®		21, 141
BANHAM ®	REINO UNIDO	16
BAODEAN	CHINA	126
BAODELI ®	CHINA	16
BARCZ ®	POLONIA	16
BARIER ®	RUSIA	146
BARRO ®		37
BASCO ®		66, 150, 170, 203, 204, 205, 207, 208, 209, 210, 212, 221, 225, 226, 299, 306, 348, 351
BASI ®	ALEMANIA	16, 126, 140
BASTA ®	IRLANDA	17, 74, 152, 154, 317, 318, 321, 323, 326, 329, 333, 336, 339, 341, , 346, 348, 349
BATON ®	TAIWAN	126
BATU ®	ESPAÑA	17, 30, 59, 347, 246
BAU ®		110
BEFA ®		116
BELL ®		120, 121
BENCO ®		97
BENDIX ®		118, 119, 154, 225, 297, 303, 306, 339, 345, 349, 350, 352
BERAM ®		113
BERRY ®		18, 27
BERTOLOTI ®		98
BEST ®	ESTADOS UNIDOS	17
BETA ®	ITALIA	17, 317, 318, 333, 339, 345, 413, 414
BEY ®	TURQUIA	127
BIBERING ®	ALEMANIA	17312
BIELLE ®	ITALIA	17
BIFFAR ®	ALEMANIA	17, 100, 116
BILMA ®	ESPAÑA	146
BILTEMA ®		347
BIRD ®		50, 118
BKS ®	ALEMANIA	6, 18, 19, 50, 70, 118, 120, 346, 336
BLACK & DECKER ®		34
BLAU ®		150, 164, 193, 195, 196, 199, 200, 215, 236, 257, 284, 288, 289, 290, 207, 307, 309, 313, 320
BLOCK ®		183, 184
BLOCTOUT ®		20
BLOCUS ®		85, 87
BLOSTER ®		151, 159, 166, 180, 183, 184, 187, 189, 190, 191, 193, 226, 228, 234, , 256, 269, 271, 282, 294, 296, 301, 309, 323, 324, 331, 334, 335, 347, 348
BLUMA ®	ALEMANIA	372
BMB ®	ALEMANIA	20
BMC ®	ITALIA	414
BMH ®		453
BOBCAT ®		159, 257, 306, 315, 351
BODA ®	FINLANDIA	20, 26, 27, 28, 403, 414, 438
BOGATIR ®	RUSIA	414, 373
BOMBARDIER ®		350
BOMORO ®	ALEMANIA	20, 112, 236, 272, 352
BONAITI ®	ITALIA	387, 409
BORKEY ®	ALEMANIA	127

FOR:	NAT.	PAG.
BOSCH ®	ALEMANIA	151, 157, 161, 180, 228, 246, 262, 272, 273, 282, 299, 306, 307, 310, , 340, 350, 351, 352
BOULTON & PAUL ®	REINO UNIDO	20
BOXAFE ®	ITALIA	415
BRABANTIA ®	ESPAÑA	20, 32, 42, 77
BRAS ®	ESPAÑA	20
BRASIL ®	BRASIL	20
BRETER ®		122, 274, 317, 318, 319, 321, 322, 323, 324, 326, 332, 333, 334, 335, , 337, 338, 339, 340, 341, 345, 349
BRICARD ®	FRANCIA	20, 21, 67, 71, 90, 124, 127, 128, 372, 403
BRIGGS & STRATTON ®		66, 73, 155, 159, 160, 167, 171, 180, 181, 202, 203, 204, 205, 206, , 208, 209, 210, 211, 212, 214, 220, 221, 222, 224, 225, 226, 232, 233, 247, 248, 254, 255, 257, 282, 287, 297, 304, 306, 314, 315, 326, 348, 351
BRISANT ®	REINO UNIDO	127
BRITAX ®		164, 198, 220, 223, 239, 284, 265, 296
BRUMME ®	ALEMANIA	21, 59
BSS ®	SERBIA Y MONTENEGRO	21
BTV ®	ESPAÑA	21, 37, 95, 96, 126, 431, 432
BUFFO ®		4, 5, 126, 150, 346
BUGA ®	ALEMANIA	21
BUICK ®	ALEMANIA	354
BULAT ®	RUSIA	22, 127
BULIT ®		3, 64, 65, 346
BURG ®	ALEMANIA	4, 5, 22, 23, 24, 35, 61, 82, 87, 114, 127, 150, 346, 372, , 447
BURG WACHTER ®	ALEMANIA	22, 23, 24, 127, 429, 430
BURGHOWT ®		98
BUS ®	ALEMANIA	24
BUVA ®	ALEMANIA	22, 24, 52, 239
BWS ®		32, 35
BY ®		25
BYP ®		125, 132
C.A.R.S. ®		82
C.V.C. ®		125
CAB ®	ITALIA	24, 25, 118, 119, 154, 225, 297, 303, 306, 349, 350, 352
CADILLAC ®	ALEMANIA	354
CAF ®	ITALIA	415
CAIB ®		137
CAM ®		438224
CAM LOCK ®	ESTADOS UNIDOS	24
CAMA ®		150
CAMBOA ®		32
CANADA POST ®	CANADÁ	24
CAP ®		25, 85
CARAT ®		50, 118
CARL F ®	REINO UNIDO	24
CARTERO ®	ESPAÑA	24, 25
CAS ®		130
CAS CISMA ®	ITALIA	25, 453
CASAS ®		124
CASELLAS ®		337
CASH BOX ®	ALEMANIA	25, 43, 77

Índice de marcas
Marken aurkibidea
Index des marques

Markenverzeichnis
Índice de marcas
Spis marek

FOR:	NAT.	PAG.
CASI ®		91, 155, 163, 164, 177, 178, 183, 195, 197, 198, 199, 200, 202, 223, , 255, 265, 268, 269, 286, 287, 288, 290, 294, 297, 299, 301, 302, 307, 309, 310, 313, 314
CASMA ®		26, 28
CATERPILLAR ®	ESTADOS UNIDOS	350
CATOR ®		88
CAVERS ®	FRANCIA	25, 26, 126, 138, 260
CAYS ®	ESPAÑA	26, 35, 127, 139
CAZORLA ®		35
CC ®		98
CCF ®	PORTUGAL	373
CCL ®		34
CEM ®		72, 162, 163, 165, 194, 195, 196, 197, 198, 199, 200, 202, 220, 223, , 231, 239, 240, 265, 266, 267, 282, 294, 296, 301, 302, 312, 348
CEMA ®	ITALIA	26
CENTURION ®		126
CENTURY ®	REINO UNIDO	26418
CERRAMARC ®	ESPAÑA	26
CERUTTI ®	ITALIA	415, 416, 444
CES ®	ALEMANIA	26, 27, 28, 29, 127
CESSNA ®		150
CF ®		49, 435
CFP ®		116
CHANGE-O-MATIC ®		33195
CHAVO ®	PORTUGAL	5, 29, 30, 31
CHELIABINSK ®	RUSIA	29
CHEVROLET (KR) ®	ALEMANIA	354
CHEYLOCK ®	HONG KONG	29
CHG ®		50
CHICAGO ®	ESTADOS UNIDOS	29, 118, 119, 146, 154, 225, 297, 303, 306, 326, , 350, 351, 352
CHRIST ®		37
CHRYSLER ®		150, 159, 160, 170, 172, 180, 181, 202, 207, 224, 249, 254, 255, 257, , 262, 276, 286, 287, 297, 308, 309, 311
CHUBB ®	REINO UNIDO	29, 128, 403, 404, 416
CIB ®		49, 83, 85, 104
CIBC ®		49
CIBOX ®		22
CIEF ®	FRANCIA	29
CIFIAL ®	PORTUGAL	29, 373207
CILA GENTILI ®	ITALIA	30
CINA ®	TAIWÁN	12, 30, 41, 92
CISA ®	ITALIA	3, 4, 5, 6, 30, 31, 72, 73, 124, 128, 346, 347, 349, 417
CITADEL ®		3
CITROEN ®	ITALIA	354, 355, 356
CITY ®		25, 26, 49
CLARK FORK LIFT ®	ESTADOS UNIDOS	31
CLASS ®	RUSIA	418
CLASSIC ®		32
CLAUSOR ®		32, 77, 152, 155, 157, 159, 160, 161, 162, 164, 172, 174, 182, 183, 233, 215, 225, 239, 250, 253, 258, 260, 263, 265, 268, 293, 308, 309, 311, 334, 335, 336, 337, 338, 339, 340, 343, 352

FOR:	NAT.	PAG.
CLEMSA ®	ESPAÑA	32
CLICK ®		287
CLUM ®		351
COBRA ®		347
CODEM ®		131
CODKEY ®		138
COFER ®		76
COHNKO ®	RUSIA	32
COLE HERSEE ®		118, 119, 154, 225, 297, 303, 306, 349, 350, 352
COLLBAIX ®		124
COLOMENCA ®		124
COM ®	ALEMANIA	32
COMBA ®		27, 66, 100
CORBIN ®	ITALIA	32, 33, 34, 35, 37, 128, 129, 130, 150, 159, 170, 203, 204, 205, , 208, 209, 210, 212
CORNI ®	ITALIA	32, 139, 409, 418305
CORONA ®	ALEMANIA	35, 61
CORSA ®		97
COTICO ®	ALEMANIA	35
COUILLET ®		86
CR ®	ITALIA	378, 418, 419, 420
CRAIN ®		135
CRAZY LOCKS ®	TAIWÁN	35
CRC ®	PORTUGAL	32, 373
CROMODORA ®		150, 151, 156, 165, 166, 179, 183, 184, 185, 187, 188, 192, 218, 227, , 246, 256, 267, 269, 271, 282, 294, 296, 299, 301, 309, 318, 324, 325, 327, 332, 335, 338, 341, 347, 348
CRONOS ®	ESTADOS UNIDOS	447
CUBELLS ®	ESPAÑA	35
CVL ®	ESPAÑA	35, 128
CWS ®		37
DACIA ®	RUMANIA	175, 176, 247, 262, 355
DAD ®	FRANCIA	35, 37, 49, 96, 110, 111
DAELIM ®		342
DAEWOO ®		170, 176, 205, 274
DAF ®	TURQUÍA	36, 128
DAIHATSU ®		167, 177, 178, 254
DAMM ®		18
DAR-MAR ®	POLONIA	404
DARMIX ®		#N/D
DASS ®	ESPAÑA	128, 129
DATSUN ®		157, 179, 182, 183, 218, 236, 242, 243, 244, 245, 246, 272, 273, 304, , 309
DAV ®		297, 306, 311
DC ®		87
DEBEAURAIN ®	FRANCIA	55, 87, 140, 141, 373, 404
DEBEAURAIN-ND ®	FRANCIA	404
DECAYEUX ®		35, 83, 86, 139, 140
DEFA ®	NORUEGA	36178
DEHA ®		120, 121
DEKABA ®	BULGARIA	36, 75, 128, 129, 420
DELAPORTE ®	FRANCIA	36
DELCA ®	GRECIA	129
DELMET ®	POLONIA	36
DELTA ®	REINO UNIDO	129, 128, 324
DENY ®	FRANCIA	420

FOR:	NAT.	PAG.
DERLOCHE ®		87
DESAL ®		23
DESPREZ ®		87
DEXTER ®	ITALIA	36, 53, 159, 306, 351
DIAMOND ®	TAIWÁN	36
DIEBOLD ®		37, 46
DIERRE ®	ITALIA	129, 133, 136
DIFA ®		88
DIMITROVGRAD ®	RUSIA	37
DINBOX ®	NORUEGA	37
DIRAK ®		36
DJC ®		98
DNS ®		56
DOBLE SAFE ®		72, 73, 319, 339
DOBLINA ®		281, 292
DOCO ®		35
DOM ®	ALEMANIA	32, 37, 38, 39, 40, 79, 80, 96, 129, 130, 139, 162, 163, 166, 183, 184, 187, 189, 191, 194, 223, 224, 225, 231, 232, 236, 255, 256, 269, 281, 294, 313
DOMINION LOCK ®	ESTADOS UNIDOS	12, 4
DOMUS ®	ITALIA	25, 40, 130, 428
DONNER ®		67, 97
DOOR LOCK ®		374
DOUBLE CIRCLE ®	TAIWÁN	40, 41
DRAPER ®		119
DUBOIS ®		68, 69, 173, 250, 262, 297, 302, 306, 311, 312, 314, 342, 348
DUPLEX ®	RUSIA	447
DURABLE ®		22
DURALOCK ®	ESTADOS UNIDOS	41
DVERNIAC ®	RUSIA	420, 421, 447, 448
EAG ®	ALEMANIA	41
EAGLE ®	ESTADOS UNIDOS	41, 56
EAO ®		39
EBA ®		77
ECHO ®		150
ECM ®	ITALIA	41
EFER ®		29
EIKO ®	JAPÓN	41
ELBOR ®	RUSIA	421
ELCA ®		43, 44, 139
ELEDIS ®		42
ELEPHANT ®		102
ELFIN ®		26
ELMO ®		306, 351
ELSET ®		77
ELZETT ®	HUNGRIA	26, 41, 130, 405, 422
EMGE ®		87
EMHART ®		87, 129
EMKA ®	FRANCIA	36, 41, 43, 49, 153
EMOH ®		164, 284, 288, 289
ENA OQ ®		104
EP PINSON ®	REINO UNIDO	42
EPO ®		90
EQUIBATIR ®		87
ERA ®	REINO UNIDO	42, 405

FOR:	NAT.	PAG.
EREVAN ®	RUSIA	422, 448
ERINRUDE ®		352
ERMEX ®		97
ESA ®	ESPAÑA	42, 405
ESAFE ®		29, 37, 76, 98, 107, 136, 139, 140, 141
ESCO ®		5, 30, 31, 32, 33, 97
ESETY ®	ITALIA	422, 423
ESLA ®	REINO UNIDO	42
ESP ®	ESTADOS UNIDOS	42
ESS ®	ALEMANIA	42
ESSENDIA ®		5, 30, 31
ESZ ®		63
ET. POWER ®		97
ETAS ®	REINO UNIDO	42
ETNA ®		25, 84
EUREKA ®	ITALIA	42
EURO ®		35
EURO BOX ®	REINO UNIDO	42
EURO LOCKS ®	BE LGICA	17, 43, 68, 72, 73, 86, 130, 146, 319, 326, 339, 348
EURONORM ®		32, 33
EUROP ®		96
EUROPARTNER ®		33
EUROPROFIL ®	POLONIA	43, 53
EUROSPEC ®	REINO UNIDO	51, 106, 118, 405
EUROTEMPLE ®	ITALIA	423
EVERGOOD ®	TAIWÁN	43, 93
EVVA ®	AUSTRIA	43, 44
EXCEL ®	FRANCIA	44
EXEM ®		133
EXPRES ®	POLONIA	44, 51, 71, 121
EZCURRA ®	ESPAÑA	44, 130, 138, 424
EZSET ®		67
FAAB ®		150, 157, 165, 173, 185, 227, 310, 318, 322, 327, 334, 338
FAB ®	REPÚBLICA CHECA	45, 55, 269, 270
FAC ®	ESPAÑA	7, 24, 25, 45, 46, 65, 112, 130, 131, 134, 139, 424
FACCHINETTI ®		48, 131336
FACEF ®		428
FADE ®		59, 87
FAI ®		114
FAICA ®		150
FAINER ®	PORTUGAL	46
FALCON ®	ESTADOS UNIDOS	17, 46, 115
FAMA ®	BRASIL	46
FANA ®	ALEMANIA	21, 46
FARMA ®		151, 184, 219, 249, 257, 319, 322, 325, 327, 331, 336, 341, 347
FAS - YALE ®	SUECIA	405, 406
FAS ®	SUECIA	46, 424, 425
FASEM ®	ITALIA	17, 46
FASMA ®		43
FAVOUR ®	ARGELIA	47, 131
FAYN ®	TAIWÁN	131, 374
FB ®		124
FCV ®	ALEMANIA	47, 66, 131226
FEB ®	ITALIA	9, 29, 65, 84, 425

Índice de marcas
Marken aurkibidea
Index des marques

Markenverzeichnis
Índice de marcas
Spis marek

FOR:	NAT.	PAG.
FECHADURA ®	BRASIL	47
FECOR ®		37, 446
FEDERAL ®	ESTADOS UNIDOS	47, 50, 127
FEFI ®		27
FEL ®		92
FEMSA ®		165, 168, 185, 191, 246, 256, 299, 310, 317, 320, 322, 325, 334, 335, 338
FERMABLOCK ®		82
FERMOD ®		35
FERONERIA ®	RUMANIA	47, 131
FERRARI ®	ITALIA	355225
FETIS ®	ESPAÑA	425
FF ®	ITALIA	47, 48, 131284
FH ®		453
FHUR ®		63
FIAM ®	ITALIA	374, 378, 425, 426
FIAT ®	ITALIA	187, 355
FIC ®	ESTADOS UNIDOS	48
FICHET ®	FRANCIA	17, 48, 68, 100, 115, 406
FINA ®		84
FINSTRAL ®		51282
FISAM ®		151, 184, 219, 249, 257, 319, 322, 325, 327, 331, 336, 341, 347
FIST ®	ITALIA	48, 347, 348
FIST ®		48, 150, 151, 157, 159, 166, 180, 183, 184, 187, 189, 190, 191, 193, 306, 228, 234, 246, 256, 296, 299, 301, 310, 320, 322, 323, 324, 325, 324, 331, 334, 335, 347, 348
FKS ®		42, 74, 101
FLAMBO ®		39, 15
FLIETHER ®		66
FLIK ®		51
FLOHR ®		48
FLOK ®		106
FLORA ®	ALEMANIA	48, 164, 284, 288, 289
FO ®		25, 8
FONTAINE ®	FRANCIA	48, 87, 110
FORCE ®		54
FORD ®	ALEMANIA	162, 166, 178, 183, 187, 189, 191, 194, 199, 200, 202, 200, 202, 223, 231, 232, 238, 246, 256, 269, 281, 285, 288, 294, 297, 302, 305, 307, 313, 355
FORINDEX ®		87
FORT ®	FRANCIA	12, 49, 61, 119, 146, 150, 154, 193, 196, 199, 200, 215, 236, 257, , 288, 290, 299, 303, 307, 309, 313, 320, 326, 350, 352
FORTE ®	VENEZUELA	49
FORTIS ®	ESPAÑA	49
FORTRESS ®		97
FOUR CIRCLE ®		120, 121
FOUSSIER ©		133
FPB ®		84
FRAL ®		84
FREA ®		150, 156, 165, 179, 184, 185, 188, 192, 218, 227, 233, 246, 256, 267, , 299, 318, 324, 325, 327, 332, 335, 338, 341
FRECOV ®		26

FOR:	NAT.	PAG.
FRIPA ®	ALEMANIA	374
FROSER ®		3, 85, 87, 150, 172, 175, 193, 230, 252, 260, 264, 274, 277, 298, , 307, 312, 314
FT ®		55
FTH ®	FRANCIA	3, 49, 50, 57, 99, 125, 127, 131, 138
FUCHS ®		33
FUHR ®		27
FULLEX ®		51
FULTON HITCH ®	REINO UNIDO	50222
GABON ®	FRANCIA	50
GAD ®	PAISES BAJOS	347
GAINSBOROUGH ®		71, 97
GALLUS ®		50
GAMET ®	POLONIA	51
GAMMA ©		137
GAON ®		65
GARDIAN ®	RUSIA	427
GARI ®		7
GAS ®		197, 253, 261, 287
GATO ®	COLOMBIA	51
GAZ ®		242, 282, 284, 295
GBS ®		116
GBZ ®	ITALIA	51229
GE GE ®	AUSTRIA	6, 9, 21, 44, 51, 52, 95
GEBA ®	ALEMANIA	18, 52
GEBRO ®		35
GEFI ®		5, 30, 31
GELBAU ®		97
GELBON ®		183, 250, 257, 258, 262, 276
GEM ®		146, 326
GEMINI ®		133
GEMM ®		67
GENERAL MOTORS ®		155, 160, 203, 204, 206, 207, 208, 209, 210, 211, 212, 213, 220, 221, , 225, 248, 304, 314
GERA ®	ALEMANIA	32, 52, 90, 95, 133, 374
GERDA ®	POLONIA	43, 52, 53, 128, 131, 133, 136, 141
GERION ®	RUSIA	427
GETE ®		5, 30, 31
GEVY ®	GRECIA	126, 129, 131, 137
GEWIRU ®		40
GEWU ®		342
GHE ®		151
GIBBONS ®	REINO UNIDO	53
GIESCHE ®		27, 66
GIESSE ®		109
GIMAST ®	ITALIA	427
GIMN ®		87
GIOBERT ®		150, 156, 157, 158, 165, 171, 173, 179, 184, 185, 188, 192, 218, 227, , 233, 246, 256, 267, 282, 293, 299, 318, 320, 322, 323, 324, 325, 338, 341, 354, 355, 356
GIPIS ®	ITALIA	427
GIUSSANI ®	ITALIA	53
GIVI ®		326
GLAZIEV ®	RUSIA	53
GLOBE ®	TAIWÁN	53, 54
GLOSTAL ®		51311
GMB ®	CHINA	54, 125, 132

FOR:	NAT.	PAG.
GMC ®	ALEMANIA	355
GMG ®	ITALIA	428
GODREJ ®	INDIA	54, 132
GOLD DOOR ®		54
GOLLOT ®		87
GOTZ ®		66
GOYAL ®		7
GPZ ®	RUSIA	406
GR ®	TAIWÁN	54
GRAF ®		66
GRAYHILL ®		61
GRUNDMANN ®		51
GSA ®		25
GTV ®	ALEMANIA	5, 30, 31, 55, 63
GUARD ®	HONG KONG	55, 59
GUARDIAN ®	REINO UNIDO	25, 57, 407, 427
GUERVILLE R. ®	FRANCIA	55
GUIDOTTI ®		87
GUITTEL ®		4, 5, 346
GUSHENG ®	ALEMANIA	55
GUTLER ®		92
H.R.S. ®		98
HÄFELE ®	ALEMANIA	26, 27, 37, 55, 56, 68, 69, 151, 173, 250, 262, 297, 302, 306, , 312, 314, 342, 348
HAGA ®	TAIWÁN	56
HAHN & KOLB ®	ALEMANIA	56
HAIDE ®		120, 121
HALLE ®	ESTADOS UNIDOS	56
HAMA ®		195
HAMPTON ®		102
HANNO ®		26
HARKOV ®	RUSIA	56
HARLEY DAV. ®		326
HARLOC ®	ESTADOS UNIDOS	56, 97, 313
HASLER ©		138
HAYWORTH ®	ESTADOS UNIDOS	56
HB ®	ITALIA	132
HBC ®		77
HEAD ®		120, 121
HEGO ®		32
HEKNA ®	ALEMANIA	37, 39, 56
HELCO-KFV ®	ALEMANIA	374, 375
HELIX ®	TAIWÁN	56, 119, 154, 303, 350, 352
HEMA ®		110
HEMY ®		120, 121
HENDERSON ®	REINO UNIDO	56, 57, 407
HERACLES ®		50, 14
HERME ®	TAIWÁN	57
HERMES ®		120, 121, 255
HERO ®		82
HERPE ®		97
HERSEE ®		306, 351
HESTE ®		32
HEWY ®		22
HFM ®	ALEMANIA	57
HILLMANN ®		98
HINO ®		280, 352

FOR:	NAT.	PAG.
HK ®		150, 193, 196, 199, 200, 215, 236, 257, 284, 288, 290, 299, 307, 309, 320
HOBBY ®		130
HOBES ®	REPÚBLICA CHECA	57, 407
HOHRMANN ®		18, 27, 37, 51
HOK ®	TURQUÍA	57, 132, 136
HOLDEN ®	ALEMANIA	355, 356
HONDA ®		152, 155, 156, 214, 215, 265, 281, 327, 328, 329, 331
HOOPLY ©		142
HOPPE ®		22
HORSE ®	TAIWÁN	57
HRG ®		82
HSA ®		66
HTEC ®	ESPAÑA	57, 132
HTV ®	REINO UNIDO	57, 92
HUDSON ®	ESTADOS UNIDOS	57, 213, 221, 225, 233, 291, 297, 298, 303, 315, 351
HUF ®		153, 154, 155, 162, 163, 164, 170, 177, 197, 207, 212, 232, 238, 248, , 269, 284, 285, 287, 289, 290, 298, 301, 307, 310, 313, 314, 320, 329, 331, 355, 357
HUGO ®	ALEMANIA	57, 127, 132
HUNIT ®	ITALIA	57
HUTRA ®		91
HUWIL ®	ALEMANIA	37, 57, 58, 132, 246
HYMER ®		130
HYUNDAI ®		215, 216, 217, 218, 226, 240, 270
I.R. ®		117
IACAM ®		246, 3
IBEAR ®	ESPAÑA	58
IBFM ®		30, 97, 98, 117, 131, 137, 347
ICA ®	ESPAÑA	58
ICSA ®	ITALIA	58, 135
IDEAL ®		37429
IDEAL SECURITY ®		115
IDM ®	ITALIA	428
IFAM ®	ESPAÑA	49, 58, 59, 98, 126, 128, 131, 132, 139
IFOS ®		97, 98
IGS ®	FRANCIA	59
IKON ®	ALEMANIA	35, 59, 60, 61
ILARGI ®	ESPAÑA	26, 61
ILCO ®	ESTADOS UNIDOS	61
ILLINOIS ®	ESTADOS UNIDOS	29, 61, 119, 306, 351
ILS ®	ITALIA	61
IMB ®	KUWAIT	61
IMBAC ®		86
IMP ®		3, 4, 5, 346
IMPAR ®		137, 14
IMSA ®		151, 159, 166, 180, 183, 184, 187, 189, 190, 191, 193, 226, 228, 234, , 256, 269, 271, 274, 282, 294, 296, 301, 309, 323, 324, 331, 334, 335, 347, 348
INCECA ®	ESPAÑA	146
INDAUX ®		12
INGERSOLL ®	ESTADOS UNIDOS	61
INLOC ®		20

Índice de marcas
Marken aurkibidea
Index des marques

Markenverzeichnis
Índice de marcas
Spis marek

FOR:	NAT.	PAG.
INSTALL ®		98
INT ®	ALEMANIA	61
INTHER ®	ESPAÑA	132
IR ®	FRANCIA	132
ISEO ®	ITALIA	3, 62, 110, 127, 132, 133, 138, 140, 141, 154, 375, 409, 426, 428
ISEO SILVER ®		62
ISKU ®		82
ISSERSTEDT ®		32
ISUZU ®	JAPÓN	62, 222, 304, 305
ITAL ®	ITALIA	429
ITEM ®		23294
ITO ®	TURQUIA	5, 30, 31, 62, 133
IVANA ®	ALEMANIA	62
JARDI ®	ESPAÑA	62, 63
JD ®		9, 88
JET ®		3
JINLONG ®	TAIWÁN	63
JIP ®	ESPAÑA	63, 85, 87
JIS ®	ESPAÑA	63, 134
JJ ®		35
JL ®		49
JMP ®		3, 5
JNF ©	PORTUGAL	133
JOHN DEERE ®		324
JOLI SAFE ®		103
JOMA ®	ESPAÑA	25, 58, 59, 63, 93
JORE ®		115, 116
JOSTA ®		26
JOVI ®	ESPAÑA	7, 63
JOWIL ®	ALEMANIA	55, 63, 64
JPM ®	FRANCIA	3, 30, 64, 134, 407
JTF ®	FRANCIA	64
JU ®		69, 111
JU JUNGINGER ®	ALEMANIA	64
JUGODENT ®		162, 166, 178, 187, 189, 191, 194, 223, 225, 231, 232, 256, 269, 281, 313
JUNGHEINRICH ®	ALEMANIA	64
JUNGST ®		63
JUNIE ®	ALEMANIA	64
JUNKUNC ®	ESTADOS UNIDOS	64, 65
JUWEL ®	ITALIA	429, 43
JUZU ®	ESPAÑA	65
JVAL ®	PORTUGAL	65
K+K ®		76, 29
KABA ®	SUIZA	133, 134
KABS ®	ALEMANIA	65
KALE ®	TURQUIA	3, 65, 134, 430
KALUGA ®	RUSIA	65
KAMAZ ®		151
KAP ®	RUSIA	65
KARDEX ®		26, 87
KARO ®		131, 294
KASSBOHRER ®		151
KASSEL ®	ITALIA	430
KATE ®		92
KAWASAKI ®		217, 321, 323, 329, 330, 340
KAWE ®		32, 33, 97, 115
KAZAN ®	RUSIA	65, 66

FOR:	NAT.	PAG.
KEMEN ®		7
KENWORTH ®	ESTADOS UNIDOS	66, 221, 225, 226, 233, 348
KERBEROS ®	RUSIA	431
KESO ®	SUIZA	134, 135
KEYA ®		3, 146, 150, 193, 230, 274
KFV ®	ALEMANIA	66, 131
KIA ®		198, 217, 226
KICHINEV ®	RUSIA	66
KIFER ®		7
KIFERM ®	FRANCIA	66, 68, 69, 86, 151, 173, 183, 250, 262, 264, 266, 274, 277, 285, 297, 302, 306, 311, 312, 314, 335, 342, 348
KIMA ®		27
KIND ®		22, 26
KIROVMACH ®	RUSIA	66
KITTY ®		2
KLIT ®		110, 154
KN ®		164, 284, 288, 289
KNAPP ®		26
KOLB ®		157, 162, 177, 194, 197, 199, 200, 202, 223, 239, 246, 265, 273, 284, 302, 340, 351
KOMATSU ®		352
KP ®	RUSIA	66
KRAMATORSK ®	RUSIA	66
KREMENCHUG ®	RUSIA	67
KREPISH ®	RUSIA	431
KRESTI ®	RUSIA	375, 376, 335
KROST ®		24
KTM ®		317, 318, 326, 327, 329, 331, 334, 335, 341, 342, 345
KUNERT ®		30, 347
KURZEME ®	RUSIA	431
KVR ®		25
KWIKSET ®	ESTADOS UNIDOS	67
KYMCO ®		331
KYNNARPS ®	REINO UNIDO	67
KYR ®		138
LABOFA ®		51
LADA BAKONY ®		227, 241, 242
LAFONTE ®	BRASIL	67
LAGRANDE ®		61
LAMA ®		78, 99, 321
LAMPA ®		26
LANCIA ®	ITALIA	356
LANE ®		34
LAPERCHE ®	FRANCIA	25, 67, 68, 87, 88, 110, 135, 407, 408
LAPORTE ®	FRANCIA	68, 153, 157, 236, 301, 306, 351
LAR ®	ESPAÑA	408, 444, 445
LAREDO ®		50, 118
LARK ®	TAIWÁN	53, 68
LAS ®	FRANCIA	68, 69, 86, 151, 173, 250, 262, 276, 297, 302, 306, 311, 312, 314, 342, 348
LASBOLAGET ®	SUECIA	69, 92, 133, 134, 408
LEFEBURU ®		29
LEGALLAIS ®	FRANCIA	69, 126, 132
LEGGÉ ®	REINO UNIDO	69230

FOR:	NAT.	PAG.
LEHMANN ®		79, 80, 137
LEN-LOK ®		71
LEROY MERLIN ©		133
LEXUS ®		207, 231, 236, 280
LG ®		12
LINCE ®	ESPAÑA	9, 69, 70, 135, 431
LINDE ®		152, 164, 284, 288, 289
LION ®		64, 65
LIONA LIOX ®		87
LIPS ®	PAÍSES BAJOS	70, 85
LISTA ®		37
LITTO ®	BÉLGICA	10, 32, 70
LM ®		97
LML ®		154, 317, 318, 321, 323, 326, 329, 333, 336, 339, 341, 345, 349
LMP ®		183, 250, 257, 258, 262, 276
LOB ®	POLONIA	71, 121, 136, 140, 143
LOCK ®	MÉXICO	3, 71, 346
LOCK-IT ®	REINO UNIDO	376
LOCKSYS ©		138
LOCKWOOD ®	ESTADOS UNIDOS	71
LOGO ®	ITALIA	71, 72, 109
LORI ®		56
LOTUS ®		120, 121
LOWE & FLETCHER ®	REINO UNIDO	43, 49, 72, 73, 74, 146, 164, 169, 171, 181, 195, 202, 220, 223, 232, 234, 247, 265, 274, 282, 296, 301, 303, 319, 326, 339, 348
LT ©	CHINA	135
LUCKY ®	TAIWÁN	74
LUCO ®		54
LUMA ®	ESPAÑA	74
LUME ®		53
LUXOR ®		98
LYF ®	ESPAÑA	146
M&D ®		36, 128
M.LUNA ®		3
MACK ®		306
MACOR ®	ESPAÑA	448
MAFOR ®	FRANCIA	87, 377, 408
MAGNETI MARELLI ®		156, 157, 165, 185, 219, 228, 299, 320, 322, 323, 324, 325
MAGNUM ©	REINO UNIDO	135
MAKERSAN ®		168
MARC ®		74, 136
MARCADET ®		68, 348
MARIANI ®	ITALIA	74
MARK ®		102
MARQUES ®	PORTUGAL	74, 136, 348
MARS ®		42
MARUTI ®		233
MASTER ®	ESTADOS UNIDOS	33, 67, 74, 75, 136, 142
MASTER LOCK ®	CHINA	136
MASTERCRAFT ®		97
MATTEY ®		96
MAUER ®	PAÍSES BAJOS	36, 75, 128, 129, 136, 420
MAUSER ®		26
MAVE ®		409
MAXIGARD ®		50

FOR:	NAT.	PAG.
MAXIM ®	RUSIA	448
MAXUS ®	UCRANIA	75
MAZDA ®		199, 202, 234, 235, 236, 280
MBB ®		27
MCL ®	RUSIA	76
MCM ®	ESPAÑA	76, 77, 136, 408, 431, 432
MD ®		132, 133
ME FA ®	TAIWÁN	77
MECALUX ®		7, 37
MECO ®	ALEMANIA	77
MEDOS ®	POLONIA	77
MEGA ®	RUMANIA	57, 132, 136
MEGABLOCK ®		428
MELSMETALL ®	ALEMANIA	22, 77
MENOVA ®		37
MERCURE ®		68, 348282
MERCURY ®		351
MERIT LINDE ®		151, 152
MERKUR ®		63
MERMIER ®		32, 34
MERONI ®		25, 43, 77, 78, 146, 321
METAL ®	BULGARIA	78, 432
METALCASTELLI ®		56, 85
METALCHIMEX ®		98
METALUX ®	FRANCIA	78, 98, 110, 140
METEOR ®	ALEMANIA	18, 37, 69, 78
METIZ ®	RUSIA	78
METTEM ®		421
MG MONTI ®	ITALIA	78, 136
MHA ®	CHINA	137
MIA ®		438
MIAN ®		54
MIBRA ®		72
MICHEL SEAT ®	ITALIA	78, 83
MIGNON ®		118
MILA ®	DINAMARCA	78, 79
MILES ®	RUSIA	79, 46
MING TAY ®	TAIWÁN	79
MINI MOLA ®	PORTUGAL	377
MIRAGLIO ®		150, 156, 165, 179, 184, 185, 188, 192, 218, 227, 233, 246, 256, 267, 299, 318, 324, 325, 327, 332, 335, 338, 341, 0, 0, 0, 0, 0
MISCELLANEOUS ®		79
MITSUBISHI ®		167, 171, 180, 182, 213, 222, 241, 248, 303, 305, 308, 350, 351
MIWA ®	JAPÓN	79
MLM ®	ALEMANIA	37, 79, 80, 87, 96, 137
MOBELLA ®	SUECIA	80, 408
MODERN ®		110
MOFA ®		150
MOFLEX ®		82
MOGILEV ®	RUSIA	80263
MOIA ®	ITALIA	432, 448
MON ®	ESPAÑA	80
MONACOR ®		9
MONDIAL ®		55, 87, 152
MONOBLOC ®	FRANCIA	25, 8
MOREAUX ®		37, 87, 114, 129, 377
MOSKVA ®	RUSIA	409

Índice de marcas
Marken aurkibidea
Index des marques

Markenverzeichnis
Índice de marcas
Spis marek

FOR:	NAT.	PAG.
MOSKVITCH ®		242
MOSRENTGUEN ®	RUSIA	80
MOTTURA ®	ITALIA	80, 131, 137, 432, 433, 434, 435
MP ®	ITALIA	409
MP PLODARI ®	ITALIA	80
MR ®		97
MSM ®		80, 137
MST ®		25
MSV ®	PORTUGAL	81, 377
MUEL ®	FRANCIA	460
MUKRA ®		32, 33
MULTLOCK ®	ISRAEL	81, 137
NABOB ®	ISRAEL	377
NATIONAL CABINET ®	ESTADOS UNIDOS	81
NB ®		5, 30, 31, 48
ND ®		104, 140, 141
NEIMAN ®		152, 157, 159, 160, 161, 164, 173, 189, 215, 239, 250, 253, 258, 261, 265, 296, 301, 310, 314, 320, 323, 329, 331, 352
NEMEF ®	ALEMANIA	26, 27, 28, 32, 81, 87, 377, 453
NEWMAN TONKS ®		97
NICO ®		49, 66
NISSAN ®	JAPÓN	157, 179, 182, 218, 243, 245, 272, 304, 305, 309, 356
NOBO ®		37, 39
NOORI ®	ALEMANIA	137
NORDWEST ®		48, 91
NOVA ®	ALEMANIA	81, 101
NOVOFERM ®		32
NOXXA ®	PAÍSES BAJOS	81
NUMIDA ®		42, 87
O.M.R. ®		432
OAL ®		34, 53
OASA ®		409
OCARIZ ®	ESPAÑA	81
OCTAVO M. ®	RUSIA	81
ODA ®		10, 11, 29
OFITA ®	ESPAÑA	81
OIAUS ®		8
OJMAR ®	ESPAÑA	26, 81, 82, 137
OLIVA ®	ITALIA	82
OLIVETTI ®	ITALIA	82
OMA ®	ITALIA	82
OMEC ®	ITALIA	82, 83, 137, 435
OMIV ®	ITALIA	17, 83
OMR ®	ITALIA	78, 83, 448
ONIUM ®		106
OPEL-CHEVROLET ®		354, 355, 356
OPEL-VAUXHALL ®	RUMANIA	356
OPEL-VAUXHALL ®	ALEMANIA	356
OPSIAL ®		65, 134
ORBA ®		92
ORDO ®	FRANCIA	68, 79, 80, 83, 348
ORENGO ®	ESPAÑA	7, 409, 435, 445
ORION ®		97
ORION NOVOX ®	FRANCIA	83
ORLANDO ®		58
ORO ®	ISRAEL	83

FOR:	NAT.	PAG.
ORONA ®		370
ORSHA ®	RUSIA	83
OSKO ®		63
OSMET ®		409
OSTMARK ®	ALEMANIA	409
OTIS ®		59, 61
P&C.I. ®	ESTADOS UNIDOS	147
PADO ®	BRASIL	83
PANHARD ®		287
PANTHER ®		63
PAPAIZ ®	BRASIL	83, 84, 377
PAS ®		85
PASSEPARTOUT ®	FRANCIA	409
PASSY ®		86
PASTORE ®		85, 302
PATENT ®		409
PATRONE ®	ITALIA	435
PAYKAN ®		98
PB ®		82
PC ®	ITALIA	17, 65, 84, 147
PCO ®		71
PEBRA ®		168
PENT ®		140
PENZMASH ®	RUSIA	84
PERINO ®		409
PEROHAUS ®		39, 51, 64, 151
PERRIER ®		55
PETCO ®		67
PETERBORO ®		40
PETROZAVODSK ®	RUSIA	84
PEUGEOT ®	FRANCIA	356, 357
PFAFFENHAIN ®	ALEMANIA	84, 85
PGO ®		338
PH ®		141
PHILLIPS ®	MÉXICO	85, 127
PHOENIX ®	REINO UNIDO	85
PICARD ®	FRANCIA	17, 138
PICARDIE ®		50, 99, 139
PJ ®		69, 87, 150, 173, 175, 220, 250, 262, 266, 274, 277, 285, 289, 297, 306, 311, 312, 314, 342
PK ®		69, 173, 250, 262, 297, 302, 306, 311, 312, 314, 342
PLUS ®		4
PM ®		87
POLAR ®		180, 246, 273, 340
POLLAK ®		159, 257, 306, 315, 351
POLLUX ®	FRANCIA	85
PORTRISA ®		139
POS ®		151, 164, 284, 288, 289
POSSE ®		67
POTENT ®	ITALIA	78, 138, 435, 436
PP ®		35
PRAZIS ®		378
PREFER ®	ITALIA	82, 85, 86, 138, 436, 437, 448
PREMI ®		78
PRESTA®		20, 153, 236, 301, 306
PROAUTO ®		3, 150, 193, 230, 274
PROBAT ®		49

FOR:	NAT.	PAG.
PROGRES ®		48, 334
PROMO ®		85
PROTEC ®		25
PUCH ®		344
PZ ®		18, 19
QCM ®		35, 104
QCP ®		25
RADIAL ®		141
RAM ®		120, 121
RAUCO ®		56
REDY ®		71
REGAL ®	REINO UNIDO	86, 298
REGENT ®		56
REMO ®		58
REMOCON ®		141
RENAG ®	NORUEGA	409
RENAULT ®	FRANCIA	357
RENAULT DACIA ®	RUMANIA	357
RENZ ®	ALEMANIA	37, 68, 69, 86, 151, 215, 348
REVI ®	ESPAÑA	437
REX ®	DINAMARCA	86, 409, 410
RGM ®	ESPAÑA	86
RIAZIAN ®	RUSIA	86
RICOUARD ®	FRANCIA	86, 282
RIEJU ®		122, 154, 274, 317, 318, 319, 321, 322, 323, 324, 326, 329, 332, 333, 335, 336, 337, 338, 339, 340, 341, 345, 349
RIGA ®	RUSIA	86
RIGAL ®	RUSIA	437
RIL ®	ESPAÑA	86, 46
RIPA ®	ESPAÑA	59, 87
RITA ®		87
RITTAL ®		22, 23
RIV ®		104
ROC ®		50, 118, 246
RODES ®	PORTUGAL	87, 136
RONEO ®		7, 87, 112
RONIS ®	FRANCIA	67, 68, 74, 77, 87, 88, 153, 175, 234, 252, 257, 260, 264, 277, 306, 307, 312, 348, 377
ROOL A DOOR ®		15
ROOTES ®		171, 202, 274
ROS ®		183, 250, 257
ROSS ®		308, 309
ROSSETTI ®	ITALIA	138
ROTO ®		22, 52, 128, 134
ROYAL ®	TAIWÁN	4, 5, 88, 113, 120, 121, 346, 349
RS ®		82
RST ®		20
RUBEN ®	RUSIA	437, 445, 448
RUE ®	FRANCIA	445
RUFFINI ®		150, 156, 165, 179, 184, 185, 188, 192, 218, 227, 233, 246, 256, 267, 299, 318, 324, 325, 327, 332, 335, 338, 341
RUKA ®		37, 111
RUKO ®	DINAMARCA	88, 89
RUSSIA ®	RUSIA	89
RUSSWIN ®	ESTADOS UNIDOS	89

FOR:	NAT.	PAG.
RUTALCHI ®		7
SAAB ®		267
SABT ®	KUWAIT	89
SADV ®		21, 87, 175, 252, 260, 264, 277, 298, 306, 307, 312, 314, 258
SAFE ®	ITALIA	151, 159, 166, 180, 183, 184, 187, 189, 190, 191, 193, 226, 228, 234, 256, 269, 271, 282, 294, 296, 301, 309, 319, 323, 324, 331, 334, 335, 338, 347, 438
SAG ®		85, 423, 428
SAM ®	RUSIA	89, 90, 438
SAMSONITE ®	ESTADOS UNIDOS	90
SANCHUN ®		120, 121
SANEL ®		87
SANPEUR ®		112
SANTIS ®		26, 27
SANTOS ®		84, 137
SANY ®		9
SARGENT ®	ESTADOS UNIDOS	90
SATURN ®	ALEMANIA	90, 126
SCHARER ®	ESTADOS UNIDOS	87, 9
SCHLAGE ®	ESTADOS UNIDOS	15, 90, 91
SCHLECHTENDAHL ®	ALEMANIA	91
SCHLEGEL ®		37
SCHRITT ®		61
SCHUCO ®	ALEMANIA	3, 5, 30, 31, 66, 91
SCHURING ®		100
SCOVILL ®		15
SCUDO®		125
SE ®		55, 97, 139
SEA ®	SUIZA	138
SEAT ®	ALEMANIA	166, 173, 357, 178, 176, 187, 189, 191, 194, 218, 223, 225, 228, 256, 267, 268, 269
SECURE ®		94
SECUREMME ®	ITALIA	138, 438, 439
SECURIKEY ®		43, 77
SECURITAL ®	ITALIA	49, 138
SEEBURG ®		61
SEIMA ®		183, 250, 257, 258, 262, 276
SELECT ®	FRANCIA	91, 41
SELIVANOVSK ®	RUSIA	91
SEMEL ®		63, 95
SEN ®		66
SENTRY SAFE ®	ESTADOS UNIDOS	910
SERMEC ®	ITALIA	439
SERRALLER ®	ESPAÑA	7, 8, 35, 58, 124, 138, 139, 449
SERRETA ®	ESPAÑA	91, 46
SES ®		98
SESA ®		87, 88
SEZAN ®		120, 121
SHANGAI ®	TAIWÁN	92
SHAW ®	REINO UNIDO	92
SHAW WALKER ®	ESTADOS UNIDOS	92
SHERLOCK ®		54
SHILUTE ®	RUSIA	92

Índice de marcas
Marken aurkibidea
Index des marques

Markenverzeichnis
Índice de marcas
Spis marek

FOR:	NAT.	PAG.
SHOWA ®		90
SIAM ®		25, 92
SIAS ®	ITALIA	439
SIB ®		26, 135
SIBI ®	ITALIA	439, 449
SIDERAL ®	ITALIA	439
SIDESE ®	ESPAÑA	92
SIDLEEN ®		44
SIEBAU ®		27, 1
SIL ®		46, 93, 107
SIMATIC ®		92
SIMECA ®	SUIZA	53, 92
SIMPLEX ®		87, 156, 167, 169, 175, 224, 231, 240, 252, 260, 277, 299
SINJET ®		37
SIPEA ®		156, 165, 167, 179, 184, 185, 188, 192, 219, 227, 228, 233, 246, 256, 271, 296, 299, 310, 317, 319, 325, 336, 338
SIS ®	ITALIA	92
SISO ®	ITALIA	25, 44, 82, 93
SISPA ®		153, 188, 190
SJL ®	RUSIA	93
SKILMANN ®		33
SKODA ®	ALEMANIA	357
SMET ®		409
SOBINCO ®		25, 93
SOFER ®	PORTUGAL	93
SOFI SONAFI ®	PORTUGAL	93
SOLER ®	ESPAÑA	93
SOLID ®		27
SOLOR ®		88
SONICO ®		32
SOPRANO ®	BRASIL	93
SOS ®	FRANCIA	25, 50, 93, 98, 377
SP ®		131
SPEEDAL ®		26, 28
SPIDER ®	ISRAEL	138
SQUIRE & S. ®	REINO UNIDO	94
SS ®		27
SSANGYONG ®		270
STA LOCK ®	REINO UNIDO	94
STAM ®		47
STANDARD ®		5, 30, 31
STANDERS ®	ESPAÑA	127, 138
STAR ®	JAPÓN	94
STARLET ®	ALEMANIA	32, 95
STARRY LOCK ®		97
STEELCASE ®		29, 57
STEIGA ®		37
STEKLOMASH ®	RUSIA	95
STEM ®	ALEMANIA	95
STERLING ®	REINO UNIDO	95
STHALEX ®		97
STIQAM ®		25, 104
STIQUAM ®		409
STORWALL ®		92
STRAFOR ®		68, 87, 348
STRATTEC ®		196, 198, 201, 239, 302
STREBOR ®	REINO UNIDO	72, 95, 153, 169
STREMLER ®		20, 25, 32, 87, 110

FOR:	NAT.	PAG.
STS ®	ESPAÑA	24, 37, 95, 96, 130, 138, 139, 140, 183, 184, 349
STUBLINA ®	SERBIA Y MONTENEGRO	96
STUMPF ®	ALEMANIA	96
STUMPF METALL ®		82
STUV ®	ALEMANIA	26, 27, 37, 40, 79, 80, 87, 88, 96
STV ®		83, 137
SUBARU ®	JAPÓN	272, 273, 357, 358
SUF ®		49
SUKI ®		48
SUL ®		32
SUREX ®	FRANCIA	96
SURFINOR ®		48
SUYOKA ®		7
SUZUKI ®		208, 213, 223, 233, 275, 319, 321, 329, 330, 332, 336, 338, 340
SWAN ®		120, 121
SWEDA ®		85
TAITO ®	JAPÓN	96
TALLINN ®	RUSIA	96, 97
TANLOCKS ®		69
TAP-AGIS ®		154
TARONI ®	ITALIA	139
TAS ®		17
TATA ®		233, 277
TAYLOR ®	ESTADOS UNIDOS	95, 97
TAYMOR ®		97
TECHNAL ®		97
TECHNO ®	ALEMANIA	97
TECHPRO ®		140
TECNO ®		58, 106
TECNOLAR ®		139
TECNOR ®		48
TECON ®	ESPAÑA	97, 139
TECSESA ®	ESPAÑA	139, 439
TECUMSEH ®		352
TEICOCIL ®	PORTUGAL	97, 101, 101, 131, 279
TEKA ®	SUECIA	12, 97
TELFORD ®		72, 195, 348
TEM ®	ESPAÑA	58, 59, 97
TERCA		124
TESA ®	ESPAÑA	3, 58, 62, 97, 98, 113, 132, 139, 140, 349, 372, 410
TESIO ®	ITALIA	33, 44
TESTA ®		25
TH ®	ALEMANIA	98276
THIRARD ®		49, 50, 127, 131
THOMAS LAIDLAW ®		139
THONE ®		32
THT ®		132
TIBBE ®		168, 178, 223
TICINO ®	ITALIA	98
TIEFENTHAL ®		41, 55, 63
TIFON ®	TAIWÁN	98
TIGRIS ®	REINO UNIDO	98
TITAN ®	ESLOVENIA	67, 98, 99, 104, 140, 141, 154, 343
TITANO ®	ITALIA	440
TITUS ®		117
T-KEY ®	CHINA	99, 14

FOR:	NAT.	PAG.
TM ®		37
TOK WINKHAUS ®	ALEMANIA	17, 99, 100, 101
TOKAJ RIKA ®		154, 167, 178, 179, 206, 207, 208, 214, 217, 223, 232, 275, 276, 278, 280, 281, 304
TOMSK ®	RUSIA	101
TOOL BOX ®		
TOP ®	ALEMANIA	81, 101
TOPLOCK ®		137, 14
TOUCH ®	REINO UNIDO	101
TOVER ®	ESPAÑA	101, 126, 131, 140, 440
TOY ®		146
TOYOTA ®		154, 167, 178, 179, 206, 207, 214, 217, 223, 232, 236, 267, 273, 275, 278, 279, 280, 281, 285, 304
TR ®	ITALIA	440
TRAMA ®		185, 227, 246, 256
TRAVEX ®	PERÚ	101, 31
TREE ®		31
TRELOCK ®	ALEMANIA	99, 100, 101, 102, 111, 154, 349
TRI STAR ®	TAIWÁN	102
TRI-CIRCLE ®	TAIWÁN	40, 102, 103
TRIMARK ®	ESTADOS UNIDOS	103
TRINITY ®		79
TRIO-VING ®	NORUEGA	103, 372, 410, 411, 296
TRITON ®		27, 63
TRIUMPH MOTORCYCLE ®		342
TROMER ®		136
TRUMPH ®		98
TRUPER ®	ESTADOS UNIDOS	104
TRW-SIPEA ®		155, 159, 171, 173, 229
TRYBA ®		44
TSAG ®	ESPAÑA	147181
TSC ®		44
TUFF ®	HONG KONG	377, 378391
TULA ®	RUSIA	104
TURSAN ®		65
TURSCHLOSS ®		17
TUSHINO ®	RUSIA	104, 44
TUTIS ®		41
TZAFRER ®	REINO UNIDO	30, 51, 104
UBE ®		155, 163, 164, 197, 255, 269, 284, 286, 287, 288, 289, 290, 298, 301, 313, 314
UCEM ®	ESPAÑA	35, 104, 112, 140, 141, 411
ULIANOVSK ®	RUSIA	104, 105
ULTION ®		127
ULTRA ®		72, 73, 348
UMF ®	PORTUGAL	105
UNIFOR ®		85
UNION ®	REINO UNIDO	72, 105, 106, 163, 165, 168, 169, 220, 224, 231, 240, 267, 281, 292, 302, 312, 319, 320, 337, 348, 349, 412
UNIPART ®		WAS-8 GILTZA
UNIVERSAL		106, 107, 108, 109, 110, 141, 378
URBIS ®	RUMANIA	110, 141
URKO ®	ESPAÑA	110, 46
US ®		64341
U-SHIN ®		252, 280, 355, 356, 357, 358

FOR:	NAT.	PAG.
UTZ ®		72, 92
VACHETTE ®	FRANCIA	67, 68, 99, 100, 110, 111, 112, 131, 132, 133, 141, 154, 161, 172, 182, 233, 260, 262, 264, 277, 299, 312, 412, 445, 446, 453
VAGO ®		85
VARIOUS BRANDS		112, 346, 347, 348, 349, 358, 370, 384, 385, 386, 387, 388, 389, 390, 392, 393, 394, 395, 396, 397, 398, 399, 400, 401, 412, 441, 442, 445, 446, 453, 456, 457, 458, 460
VAUGHN ®		92
VBH ®	ALEMANIA	16, 99, 113, 131
VDO ®		151
VEGA ®	FRANCIA	11, 87, 113
VELO ®		120, 121
VENDI ®	RUMANIA	113
VENLOCK ®		97231
VERA ®		90337
VERSCO ®		32
VESPA ®		344
VF (VEROFER) ®		47, 131
VGF VILLATORE ®	ITALIA	113
VIDMAR ®		138
VIKI ®		37
VILLFER ®	ESPAÑA	446
VINCO ®		110, 111
VING ®	NORUEGA	113
VIP ®		25312
VIRO ®	ITALIA	2, 113, 114, 142, 154, 317, 318, 321, 323, 326, 329, 333, 336, 339, 345, 349
VISO ®		120, 121
VISONIC ®		9
VOKO ®		26, 63
VOLGA ®		242, 282, 283, 284, 295
VOLGOGRAD ®	RUSIA	114
VOLKOVYSK ®	RUSIA	114
VOLKSWAGEN ®	ALEMANIA	358
WALE ®		117, 118, 127
WALLY ®	TAIWÁN	114
WALRUS ®	TAIWÁN	114
WANJIN ®	CHINA	142310
WASO ®		26, 150, 166, 187, 189, 191, 193, 194, 196, 199, 200, 215, 223, 225, 236, 243, 244, 245, 256, 257, 269, 281, 284, 288, 290, 294, 299, 307, 309, 313, 320
WBH ®		106, 163, 169, 214, 220, 224, 225, 231, 240, 267, 282, 292, 292, 302, 349
WEBER ®	ALEMANIA	115
WEBSTER ®	REINO UNIDO	115
WECO ®		18, 26, 115, 118, 151
WEDO ®		42
WEISER ®	ESTADOS UNIDOS	46, 115
WELKA ®	ITALIA	115, 44016
WEPA ®		63
WESCO ®		164, 284, 288, 289
WESLOCK ®	ESTADOS UNIDOS	115

Índice de marcas
Marken aurkibidea
Index des marques

Markenverzeichnis
Índice de marcas
Spis marek

FOR:	NAT.	PAG.
WEST ALLOY ®		105, 163, 165, 168, 169, 220, 224, 231, 240, 267, 281, 292, 296, 302, 319, 320, 349
WEST LOCK ®	ESTADOS UNIDOS	115, 352
WHITCO ®	AUSTRALIA	115
WIGRO ®		115, 116
WILKA ®	ALEMANIA	115, 116, 142, 249
WILLENHALL ®		53
WILMOT BREEDEN ®		178, 195, 223, 281, 303
WINFIELD ®		120, 121
WINKHAUS ®	ALEMANIA	100, 117
WINLOCK ®	REINO UNIDO	117332
WINNER ®		50, 55
WIREROPE ®	HONG KONG	117
WITTE ®		155, 163, 164, 197, 255, 256, 269, 284, 288, 289, 290, 298, 301, 307, 313, 314, 355
WMS ®	REINO UNIDO	117, 412
WOC ®		50, 118
WSM ®		22
WSS ®		56, 88
WT ®	CHINA	42, 117
WÜRTH ®		56, 58
YAC ®		87
YALE ®	REINO UNIDO	18, 19, 31, 50, 66, 92, 117, 118, 119, 120, 138, 142, 150, 154, 170, 171, 180, 181, 202, 207, 224, 225, 254, 255, 264, 265, 284, 286, 287, 306, 351, 378, 412, 440, 441, 460
YALTRES ®		127, 131
YAMAHA ®		276, 293, 341, 343, 344, 345
YANEDIS ®		42
YARD ®		121
YARDENI ®	ISRAEL	121, 143
YEMAR ®		140, 141
YETI ®	TAIWAN	71, 120, 121, 136, 143
YMOS ®		153, 163, 170, 176, 177, 183, 195, 198, 202, 213, 221, 208, 221, 248, , 268, 283, 284, 288, 289, 299, 305, 307, 309
YUGO ®		294
YUN HUAN ®	CHINA	121
YVEL ®		86
YWS ®	TAIWÁN	122
ZADI ®	ITALIA	122, 151, 154, 284, 317, 318, 319, 321, 322, 323, 324, 326, 327, 329, , 333, 334, 335, 336, 337, 338, 339, 340, 341, 342, 345, 349
ZAIN ®		14, 126
ZANI ®		58
ZAZ ®		242, 282, 284, 295
ZECE ®		32
ZEISS IKON ®	ALEMANIA	59, 60, 61, 378, 379
ZENI ®	REINO UNIDO	25, 122
ZENICA ®		25
ZENITH ®		25, 92
ZIL ®		151, 284
ZILTEN ®		131
ZUNDAPP ®		342

FOR:	NAT.	PAG.
------	------	------

JMA\Headquarters

ALEJANDRO ALTUNA, S.A.
Bidekurtzeta 6, P.O.Box 70, 20500
Arrasate-Mondragon, Gipuzkoa. Spain

www.jma.es
ventas@jma.es
+34 943 793 000

JMA\France

Technoparc
13, rue Charles-Edouard Jeanneret
F- 78306 Poissy Cedex

www.jmafrance.fr
service.commercial@jmafrance.fr
+33 01 39 22 42 10

JMA\Maroc

JMA MAROC S.A.R.L.
83,85 Bd Oued ZIZ, El Oulfa
Casablanca
Marruecos

www.jma.ma
jma@jma.ma
+0520 150 535

JMA\Mexico

LLAVES ALTUNA DE MEXICO S.A de C.V
Av. Aviación No. 5520
Col. San Juan de Ocotán
C.P. 45019 Zapopan, Jalisco

www.jma.com.mx
ventas@jma.com.mx
+52 33 3777 1600

JMA\Colombia

IFAM - JMA COLOMBIA S.A.S.
Parque Empresarial Oikos La Florida
Autopista Medellín KM 2, Bodega 05
Bogotá

www.jmacolombia.com
info@jmacolombia.com
+57 3188088314

JMA\Perú

JMA Perú S.A.C.
Av. Los Paracas 130, Urbanización
Salamanca,
Distrito Ate, Lima

www.jma-peru.com
info@jma-peru.com
+51 639 9300

JMA\Polska

JMA POLSKA Sp. z.o.o.
91-342 Łódź, ul. Zbąszyńska 3

www.jmapolska.pl
biuro@jmapolska.pl
+48 42 635 12 80

JMA\Portugal

ALTUNA PORTUGAL, COMERCIO DE
CHAVES UNIPessoal, LDA.
Urbanização dos Areiros, Lote 67 C/v
2695-733 São Joao da Talha

www.jmaportugal.com
comercial@jmaportugal.com
+351 219 947 470

JMA\Uk

SKS LTD
Unit 2, Canalside Northbridge Road
Berkhamsted
Herts HP4 1EG

www.jmakeys.co.uk
sales@skskkeys.co.uk
+44 144 229 1400

JMA\USA

ALTUNA GROUP USA INC.
1513 Greenview Dr
Grand Prairie, Texas.
USA. 75015

www.jmausa.com
info@jmausa.com
+1 817 385 0515



JMA E-training



JMA E-shop

**Opening
the future**

Member of
Altuna Group



JMA[®]